



# YETDA INDUSTRY LTD.

## 0.28" TRIPLE DIGIT RED LED DISPLAY

### T-2831AUF11

#### DESCRIPTION

- \* 0.28" (7.0mm) Inch Digit Height.
- \* Red Emitting Color.
- \* Black Face and White Segment Color.
- \* Common Cathode.

#### ABSOLUT MAXIMUM RATINGS AT Ta=25°C

Parameter		UNIT
Power Dissipation Per Seg. & Dot	40	mW
Peak Forward Current Per Seg. & Dot	120	mA
Forward current Per Seg. & Dot (Static)	30	mA
Reverse Voltage Per Seg. & Dot	5	V
Operation Temperature Range	-25°C TO +80°C	°C
Storage Temperature Range	-25°C TO +100°C	°C
Lead Soldering Temperature	260°C for 3 seconds 1.6mm(1/16 inch) from body	

#### ELECTRICAL/OPTICAL CHARACTERISTIC AT Ta=25°C

PARAMETER	SYMBOL	MIN.	TYP.	MAX.	UNIT	CONDITION
Average Luminous Intensity	Iv		90		mcd	If=20mA
Emission Wavelength	$\lambda$ d		625		nm	If=20mA
Forward Voltage Per Seg. & Dot	Vf		2.0	2.4	V	If=20mA
Reverse Current Per Seg.	Ir			10	uA	Vr=5V
Luminous Intensity Matching Ratio	Iv-m		2 : 1			If=20mA



YETDA INDUSTRY LTD.

**P.C.B. Pin Connection**

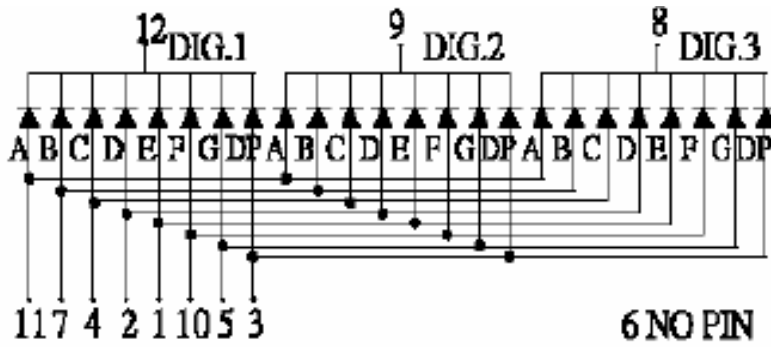

**Reflector Dimensions**

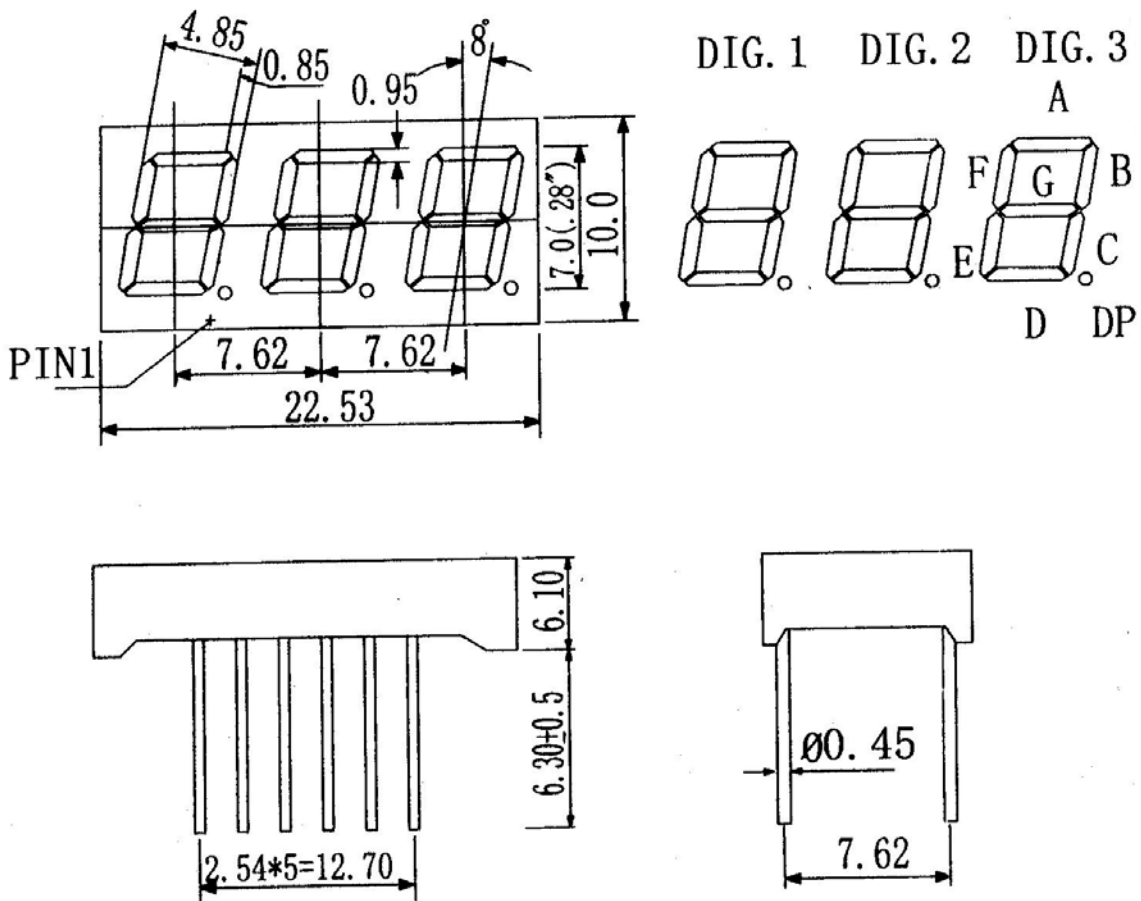

Unit:mm



# YETDA INDUSTRY LTD.

## Typical Electro-Optical Characteristics Curve

Fig 1. Forward Current vs. Forward Voltage

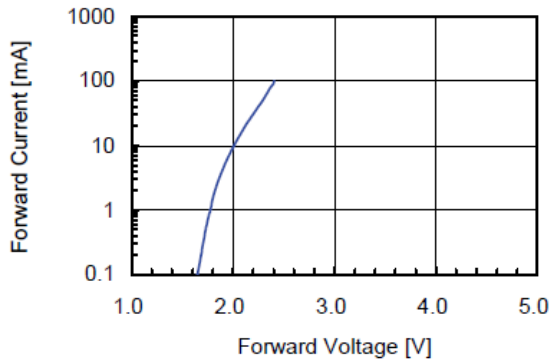

Fig 2. Relative Intensity vs. Forward Current

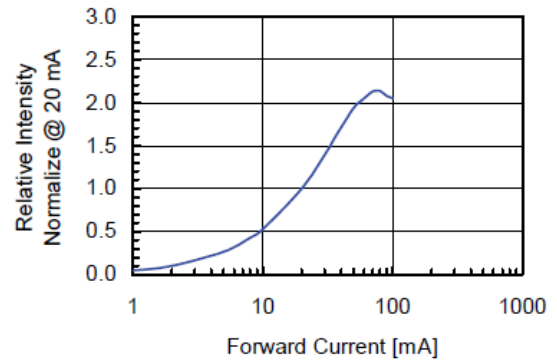

Fig 3. Forward Voltage vs. Temperature

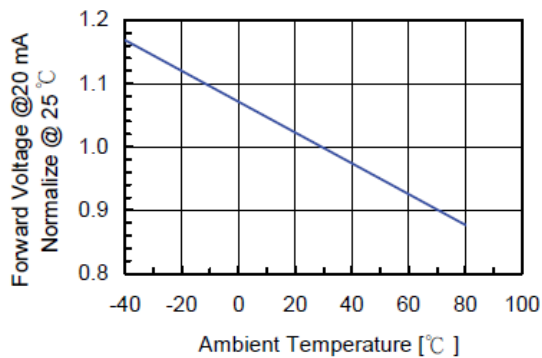

Fig 4. Relative Intensity vs. Temperature

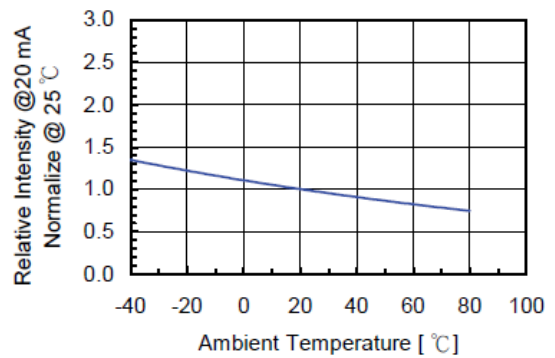
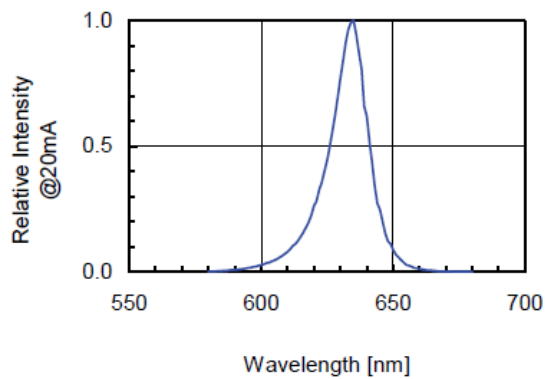

Fig 5. Relative Intensity vs. Wavelength





YETDA INDUSTRY LTD.

## Soldering

### 1. Manual of soldering

The temperature of the iron tip should not be higher than 260°C and Soldering within 3 seconds per solder-land is to be observed

### 2. DIP soldering (Wave Soldering):

Preheating: 120°C ~ 150°C within 5 sec. 260°C (Max)

Gradual Cooling (Avoid quenching)

