



DOT MATRIX LIQUID CRYSTAL DISPLAY MODULE

COMPANY NAME : Mctronic

USER 'MANUAL

SG24064E0 Serial

LCD Module Description: SGS24064E0FEY24

PROPOSED BY		APPROVED
Design	Approved	
		

SDEC TECHNOLOGY CORP.

ADDRESS: 10F, No. 100, Shing De Rd., San Chung City 241

Taipei Hsien, Taiwan R.O.C.

TEL: 886-2-2999-2512/886-2-8512-1288

FAX: 886-2-2999-2510/886-2-8512-2828

EMAIL:sdec8405@ms6.hinet.net/sdec@sdec.com.tw

<http://www.sdec.com.tw>





LCM SAMPLE APPROVAL

(液晶顯示模組樣品確認書)

1 · PART A: FILLED BY SDEC TECH (由 SDEC 填寫)

- 1) COMPANY NAME (客戶名稱) : Mctronic
- 2) SDEC ITEM NO. (產品型號) : SGS24064E0FEY24
- 3) CUSTOMER ITEM NO. (客戶產品型號) : DS11002884
- 4) LCM Function (LCM 內容) :

A	LCD TYPE (LCD 種類) : <input type="checkbox"/> TN, <input type="checkbox"/> HTN, <input checked="" type="checkbox"/> STN, <input type="checkbox"/> FSTN (<input checked="" type="checkbox"/> POSITIVE/正向, <input type="checkbox"/> NEGATIVE/反向, <input type="checkbox"/> BLACK MASK/內黑絲印)
B	VIEWING AREA (視角方向) : <input type="checkbox"/> 3H, <input checked="" type="checkbox"/> 6H, <input type="checkbox"/> 9H, <input type="checkbox"/> 12H
C	POLARIZER COLOR (偏光板顏色) : <input type="checkbox"/> GRAY/灰色, <input checked="" type="checkbox"/> YELLOW GREEN/黃綠色, <input type="checkbox"/> BLUE/藍色, <input type="checkbox"/> BLACK/黑色
D	BACKLIGHT COLOR (背光顏色) : <input checked="" type="checkbox"/> YELLOW GREEN/黃綠光, <input type="checkbox"/> ORANGE/橘光, <input type="checkbox"/> RED/紅光, <input type="checkbox"/> BLUE/藍光, <input type="checkbox"/> GREEN/翠綠光, <input type="checkbox"/> WHITE/白光
E	TEMPERATURE (溫度) : <input type="checkbox"/> NORMAL/常溫, <input checked="" type="checkbox"/> WIDE/廣溫
F	CONTROL IC (控制 IC) : T6963C

SAMPLE DELIVERY DATE (出樣日期) : 2010.11.26

2 · PART B: FILLED BY CUSTOMER (請客戶填寫)

CHECK LIST ITEMS (檢查項目) :	O K	N G	REASON (原因)
1).LCM SIZE AND THICKNESS:(LCM 尺寸及厚度):	<input type="checkbox"/>	<input type="checkbox"/>	_____
2).POLARIZER COLOR : (偏光板色澤) :	<input type="checkbox"/>	<input type="checkbox"/>	_____
3).ELECTRO CHARACTERISTIC : (電氣特性) :	<input type="checkbox"/>	<input type="checkbox"/>	_____
4).VIEWING AREA (視角範圍) :	<input type="checkbox"/>	<input type="checkbox"/>	_____
5).BACKLIGHT ILLIMINATION (背光亮度的) :	<input type="checkbox"/>	<input type="checkbox"/>	_____
6).TEMPERATURE RANGE (溫度範圍) :	<input type="checkbox"/>	<input type="checkbox"/>	_____
APPROVED BY (批准) :	DATE OF APPROVAL (批准日期) :		



REVISION RECORD

Revision	Page	Contents
Preliminary 2010.11.26	2	First Release Version Sample Delivery Date

SDEC LCD Module Numbering System

1	2	3	4	5	6	7	8	9	10	11	12	13	14	15
S	C	S		040		04		A0		H	L	T	1	0
S	G	F		320		24		A0		J	C	W	1	0
S	D	H		007		08		A0		B	N	N	0	0

Numbering System			Code Value	Description	Remark
1	Company	S	S	Company name abbreviated	SDEC CO.,LTD
2	LCM type	G	B C G O T S D	B:Big Character C:Character G:Graphic O:COG T:TAB S:Seven Segment D:Customer Design	LCM type
3	LCD type	S	T H S F D R M V A	TN type LCD HTN type LCD STN type LCD FSTN type LCD DFSTN type LCD Color TN / Color STN TFT LCD VFD VATN	LCD type
4,5,6	Row dots number Characters per line Year	128	122,128,240,320... 008,016,020,040... 006,007...	Row dots number Characters per line Year	Graphic Character Seven Segment
7,8	Column dots number Lines Month	64	32,64,128,240... 01,02,04... 01,02..12	Column dots number Lines Month	Graphic Character Seven Segment
9,10	LCD module serial number	A0	A0~ZZ	LCD module serial number	Ux -> USB Port Interface Sx -> Series Port Interface Rx -> RS-232 Port Interface
11	Polarizer Color & Viewing angle type	I	A B C D E F G H I J K L M	Gray Mode/3:00view Gray Mode/6:00view Gray Mode/9:00view Gray Mode/12:00view Yellow Green Mode/3:00view Yellow Green Mode/6:00view Yellow Green Mode/9:00view Yellow Green Mode/12:00view Negative type/3:00view Negative type/6:00view Negative type/9:00view Negative type/12:00view Other	Polarizer Color & Viewing angle type
12	Backlight type	L	N L E C	Without backlight Array LED Edge LED C.C.F.L	Backlight type
13	Backlight color (VFD color)	Y	N O A B G R Y W D T	Without backlight Orange Amber Blue Green Red Yellow-green White Double Color(Y-G&R) R G B	Backlight color
14	Font Code Type	0	0 1 2 3 A B C F U Z	No Font Table English-Japanese Font Code English-Europe Font Code English-Russian Font Code BIG-5 Chinese Font Code GB Chinese Font Code ST7920-0C Font Code ST7920-0F Font code (Korean) Unicode Other Font Code	Font Table Code Type
15	Series Code	0	0~Z		Series Code

CONTENTS

	PAGE
● LCM Sample Approval	2
● REVISION RECORD	3
● LCD Module Number System	4
1. Mechanical Specification	6
2. Mechanical Diagram	6
3. Interface Pin Connections	6
4. Block And Power Supper Diagram	6
5. Electrical Absolute Maximum Ratings	7
6. Electrical Characteristics	7
7. Optical Characteristics	7
8. Optical Definitions	7
9. Timing Control	7
10. DISPLAY CONTROL INSTRUCTION	8
11. CG ROM PATTERN	14
12. Functional Test & Inspection Criteria	15
13. Reliability Test – Normal Temperature	17
14. Reliability Test – Wide Temperature	18
15. Precautions Against Product Handling	19
16. Warranty	20

1. Mechanical Specification

ITEM	STANDARD VALUE			UNIT
DOT MATRIX FORMAT	240 × 64 DOTS			--
CONTROLLER IC	T6963C or Equivalent			
MODULE DIMENSION	180.0W × 65.0H × 13.0 D mm			mm
VIEWING DISPLAY AREA	132.0W × 39.0H			mm
ACTIVE DISPLAY AREA	127.16W × 33.88H			mm
DOT SIZE	0.49W × 0.49H			mm
DOT PITCH	0.53W × 0.53H			mm
● EGDE LED BACKLIGHT COLOR	YELLOW GREEN			
BACKLIGHT INPUT	DC+4.0 (Type)	V	390 (Type)	mA
BACKLIGHT HALF-LIFT TIME	20,000 (Ta=25°C)			HR.

2. Mechanical Diagram

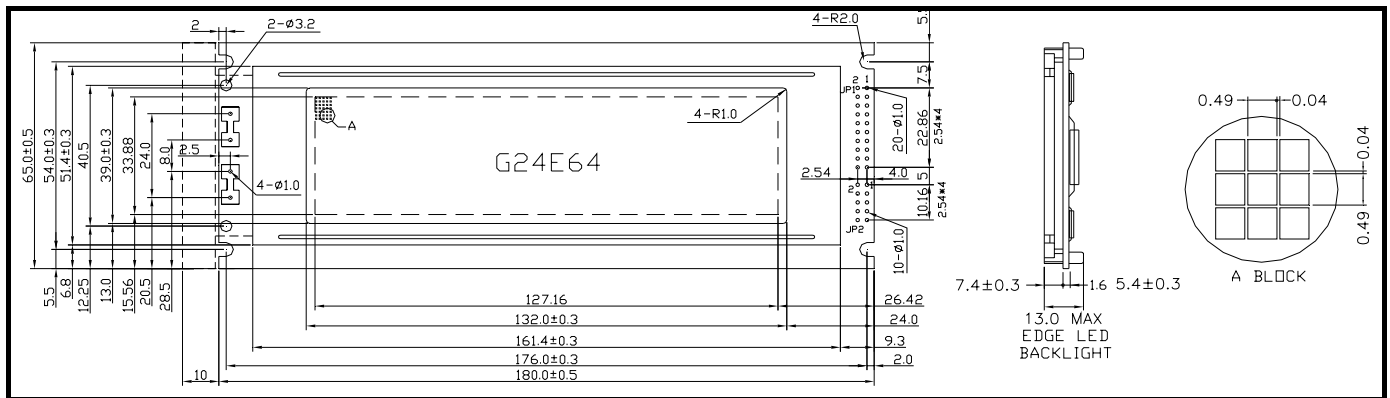

3. Interface Pin Connections

NO	SYMBOL	LEVEL	FUNCTION
1	FGND	--	Frame ground
2	V _{SS}	--	Ground potential (Logic)
3	V _{DD}	--	Power supply for Logic Circuit
4	V _o	--	Power supply for LCD Circuit
5	/WR	L	Data write
6	/RD	L	Data read
7	/CE	L	Chip enable
8	C/D	H/L	Command/Data
9	N.C	--	NO CONNECTION
10	/RST	L	Controller reset
11	DB0	H/L	Data Bit 0
12	DB1	H/L	Data Bit 1
13	DB2	H/L	Data Bit 2
14	DB3	H/L	Data Bit 3
15	DB4	H/L	Data Bit 4
16	DB5	H/L	Data Bit 5
17	DB6	H/L	Data Bit 6
18	DB7	H/L	Data Bit 7
19	FS	H/L	Font select : H:6x8 L:8x8

4. Block And Power Supper Diagram

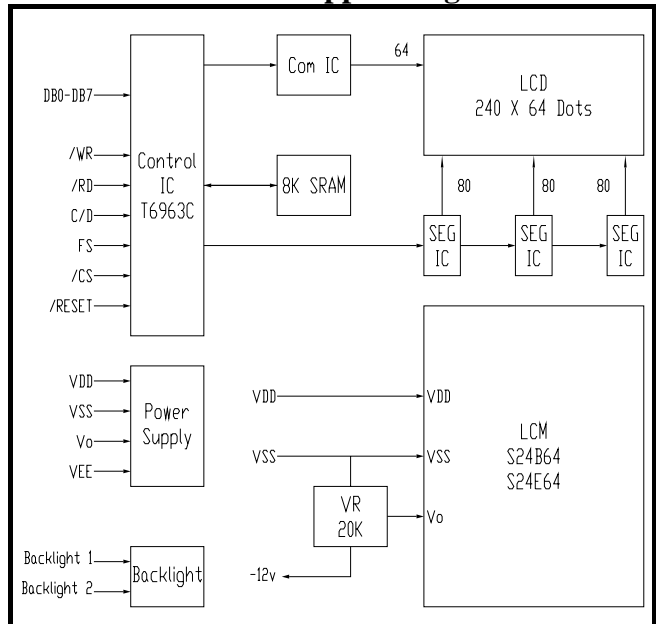

5. Environmental absolute maximum ratings

ITEM	OPERATING		STORAGE		REMARKS
	MIN.	MAX.	MIN.	MAX.	
Ambient Temperature	-20°C	+70 °C	-30 °C	+80 °C	-- NOTE 1
Humidity	NOTE 1		NOTE 2		Without Condensation
Vibration	--	4.9m/s ²	--	19.6m/s ²	XYZ Directions
Shock	--	29.4m/s ²	--	490.0m/s ²	XYZ Directions

Remarks:

NOTE (1) : Ta at 60 °C : 50 HR Max.

NOTE (2) : Ta < 40 °C : 95% RH Max.

Ta > 40 °C : Absolute humidity must be lower than the humidity of 95% at 40 °C.

6. Electrical Characteristics

ITEM	SYN	CONDITION	MIN.	TYPE	MAX.	UNIT
SUPPLY VOLTAGE FOR LOGIC	VDD-VSS	--	4.75	5.0	5.25	V
SUPPLY VOLTAGE FOR LCD	VDD-VO	Ta= 25°C	--	9.0	--	V
INPUT HIGH VOLTAGE	VIH	VDD = 5V	0.7VDD	--	VDD	V
INPUT LOW VOLTAGE	VIL	0.25	0	--	0.3VDD	V
SUPPLY CURRENT (LOGIC)	IDD	VDD=+5V	--	--	12.0	mA
	IEE	V _{EE} = -10V	--	--	5.0	mA

7. Optical Characteristics

Ta at 25°C

ITEM	SYM	CONDITION	MIN.	TYPE	MAX.	UNIT
VIEW ANGLE (TOP/BOTTOM)	$\theta 1 / \theta 2$	CR ≥ 5	--	45/35	--	deg.
VIEW ANGLE (LEFT/RIGHT)	$\phi 1 / \phi 2$	CR ≥ 5	--	35/35	--	deg.
CONTRAST RATIO	CR	--	--	7	--	--
RESPONSE TIME (RISE)	TON/Tr	--	--	160	--	mS
RESPONSE TIME (DECAY)	TOFF/Tf	--	--	210	--	mS

8. Optical Definitions

Response Time

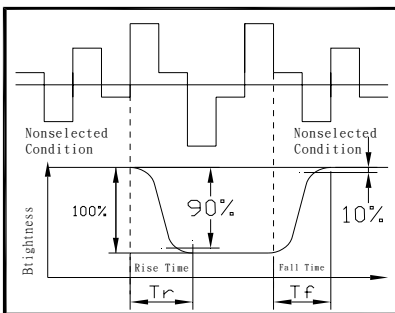

Contrast Ratio

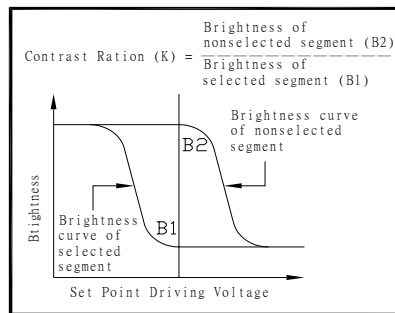

View Angle

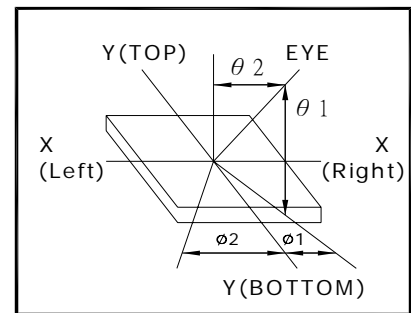

9. Timing Control

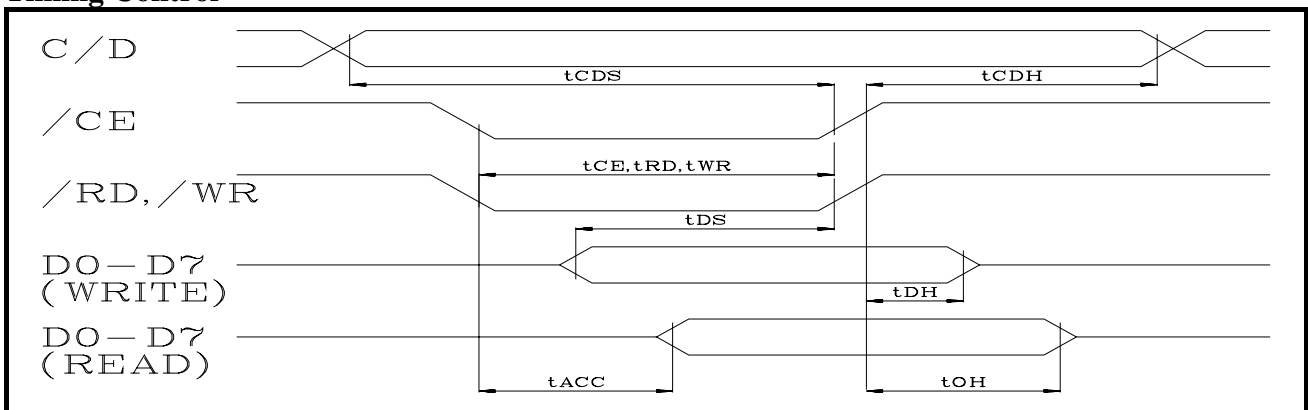

ITEM	SYMBOL	MIN	TYP	MAX	UNIT
C/D Set Up Time	tCDS	100	--	--	ns
C/D Hold Time	tCDH	10	--	--	ns
/CE, /RD, /WR Pulse Width	tCE, tRD, tWR	80	--	--	ns
Data Set Up Time	tDS	80	--	--	ns
Data Hold Time	tDH	40	--	--	ns
Access Time	tACC	--	--	150	ns
Output Hold Time	tOH	--	--	50	ns

10. DISPLAY CONTROL INSTRUCTION

10.1 Command list

COMMAND	OCDE	D1	D2	FUNCTION
REGISTER SET	00100001	X adrs	Y adrs	CURSOR POINTER SET
	00100010	data	00H	OFFSET REGISTER SET
	00100100	Low adrs	High adrs	ADDRESS POINTER SET
CONTROL WORD SET	01000000	Low adrs	High adrs	TEXT HOME ADDRESS SET
	01000001	Columns	00H	TEXT AREA SET
	01000010	Low adrs	High adrs	GRAPHIC HOME ADDRESS SET
	01000011	Columns	00H	GRAPHIC AREA SET
MODE SET	1000X000	-	-	“OR” mode
	1000X001	-	-	“EXOR mode
	1000X011	-	-	“AND” mode
	1000X100	-	-	“TEXT ATTRIBUTE” mode
	10000XXX	-	-	Internal CG ROM Mode
	10001XXX	-	-	External CG RAM mode
DISPLAY MODE	10010000	-	-	DISPLAY OFF
	1001XX10	-	-	CURSOR ON, BLINK OFF
	1001XX11	-	-	CURSOR ON, BLINK ON
	100101XX	-	-	TEXT ON, GRAPHIC OFF
	100110XX	-	-	TEXT OFF, GRAPHIC ON
	100111XX	-	-	TEXT ON, GRAPHIC ON
CURSOR PATTERN SELECT	10100000	-	-	1 LINE CURSOR
	10100001	-	-	2 LINES CURSOR
	10100010	-	-	3 LINES CURSOR
	10100011	-	-	4 LINES CURSOR
	10100100	-	-	5 LINES CURSOR
	10100101	-	-	6 LINES CURSOR
	10100110	-	-	7 LINES CURSOR
	10100111	-	-	8 LINES CURSOR
DTAT AUTO READ/WRITE	10110000	-	-	DATA AUTO WRITE SET
	10110001	-	-	DATA AUTO READ SET
	10110010	-	-	AUTO RESET
DATA READ WRITE	11000000	data	-	DATA WRITE AND ADP INCREMENT
	11000001	-	-	DATA READ AND ADP INCREMENT
	11000010	data	-	DATA WRITE AND ADP DECREMENT
	11000011	-	-	DATA READ AND ADP DECREMENT
	11000100	data	-	DATA WRITE AND ADP NONVARIABLE
	11000101	-	-	DATA READ AND ADP NONVARIABLE
SCREENPEEK	11100000	-	-	SCREEN PEEK
SCREEN COPY	11101000			SCREEN COPY
BIT SET/RESET	11110XXX	-	-	BIT RESET
	11111XXX	-	-	BIT SET
	1111X000	-	-	BIT0 (LSB)
	1111X001	-	-	BIT1
	1111X010	-	-	BIT2
	1111X011	-	-	BIT3
	1111X100	-	-	BIT4
	1111X101	-	-	BIT5
	1111X110	-	-	BIT6
	1111X111	-	-	BIT7 (MSB)

Note 1: Status check between all commands and data is recommended, though execution time for several commands is specified in above command list.

For the commands with “status check” in execution time, execution time does not specified because it is infunced by internal situation of controller LSI.

2: In case of 2 screen mode, Screen copy command cannot be used.

10.2 Description of command

10.2.1 Register set

CODE	FUNCTION	D1	D2
00100001 21H	CURSOR POINTER SET	X address	Y address
00100010 22H	OFFSET REGISTER SET	DATA	00H
00100100 24H	ADDRESS POINTER SET	LOW address	HIGH address

A) CURSOR POINTER SET

The position of cursor is specified by X ADRS, Y ADRS, The cursor position is moved only by this command. The cursor pointer doesn't have the function of increment and decrement. The shifts of cursor are set by this command.

X ADRS, Y ADRS are specified following

X ADRS	00H~4FH	(lower 7bits are valid)
Y ADRS	00H~1FH	(lower 5bits are valid)

1) 1 screen drive

X ADRS 00~4FH

Y ADRS 00H~0FH

2) 2 screen drive

X ADRS 00~4FH

Y ADRS 00H~0FH upper screen
Y ADRS 10H~1FH lower screen

B) OFFSET REGISTER SET

The offset register is used to determine external character generator RAM area.

C) ADDRESS POINT SET

The address point set command is used to indicate the start address for writing (or read) to external RAM.

10.2.2 Control word set

CODE	FUNCTION	D1	D2
01000000 40H	TEXT HOME ADDRESS SET	Low address	High address
01000001 41H	TEXT AREA SET	Columns	00H
01000010 42H	GRAPHIC HOME ADDRESS SET	Low address	High address
01000011 43H	GRAPHIC AREA SET	Columns	00H

The home address and column size are defined by this command.

A) Text home address set

The starting address of external display RAM for Text display is defined by this command. The text home address shows the left end and most upper position.

The relationship of external display RAM address and display position

TH		TH + CL
TH + TA		TH + TA + CL
(TH + TA) + TA		TH + 2TA + CL
(TH + 2TA) + TA		TH + 3TA + CL
:		:
TH + (n-1) TA		TH + (n-1) TA + CL

TH: Text Home address TA: Text Area number (columns) CL: Columns are fixed by hardware, pin-programmable

(EX) Text home address = 0000H Text area = 0020H
 MD2=H, MD3=H : 32 columns
 DUAL=H, MDS=L, MDO=L, MD1=H: 4 lines

0000H	0001H	001EH	001FH
0020H	0021H	003EH	003FH
0040H	0041H	005EH	005FH
0060H	0061H	007EH	007FH

B) Graphic home address set

The starting address of external display RAM for Graphic display is defined by this command.

The graphic home address shows the left end and most upper line.

The relationship of external display RAM address and display position

GH		GH+CL
GH+GA		GH+GA+CL
(GH+GA)+GA		GH+2GA+CL
(GH+2GA)+GA		GH+3GA+CL
:		:
GH+(n-1)GA		GH+(n-1)GA+CL

GH: Graphic Home address GA: Graphic area number (columns)
 CL: Columns are fixed by hardware. (pin-programmable)

(EX) Graphic home address = 0000H Graphic area = 0020H
 MD2=H, MD3=H : 32 columns
 DUAL=H, MDS=L, MD0=M, MD1=H : 2 lines

0000H	0001H		001EH	001FH
0020H	0021H		003EH	003FH
0040H	0041H		005EH	005FH
0060H	0061H		007EH	007FH
0080H	0081H		009EH	009FH
00A0H	00A1H		00BEH	00BFH
00C0H	00C1H		00DEH	00DFH
00E0H	00E1H		00FEH	00FFH
0100H	0101H		011EH	011FH
0120H	0121H		013EH	013FH
0140H	0141H		015EH	015FH
0160H	0161H		017EH	017FH
01A0H	01A1H		01BEH	01BFH
01C0H	01C1H		01DEH	01DFH
01E0H	01E1H		01FEH	01FFH

C) Text area set

The columns of display are defined by the hardware setting. This command can be used to adjust columns of display.

(EX) LCD size: 20 columns, 4 lines
 Text home address = 0000H Text area = 0014H
 MD2=H, MD3=H : 32 columns
 DUAL=h, MDS=L, MD0=L, MD1=H : 4 lines

0000	0001	0013	0014	001F
0014	0015	0027	0028	0033
0028	0029	003B	003C	0047
003C	003D	004F	0050	005B



D) Graphic area set

The columns of display are defined by the hardware setting. This command can be used to adjust columns of graphic display.

(EX) LCD size: 20 columns, 2 lines
 Text home address = 0000H Text area = 0014H
 MD2=H, MD3=H : 32 columns
 DUAL=H, MDS=L, MD0=H, MD1=H : 2 lines

0000	0001	0013	0014	001F
0014	0015	0027	0028	0033
0028	0029	003B	003C	0047
003C	003D	004F	0050	005B
0050	0051	0063	0064	006F
0064	0065	0077	0078	0083
0078	0079	008B	008C	0097
008C	008D	009F	00A0	00AB
00A0	00A1	00B3	00B4	00BF
00B4	00B5	00C7	00C8	00D3
00C8	00C9	00DB	00DC	00E7
00DC	00DD	00EF	00F0	00FD
00F0	00F1	0103	0104	011F
0104	0105	0127	0128	0123
0118	0119	012B	012C	0137
012C	012D	013F	0140	014B



The address in graphic area can be continuous and RAM area can be used without ineffective area, if graphic area is defined the same number as the actual column number of LCD display.

10.2.3 Mode set

CODE	FUNCTION
1000X000	“OR” mode
1000X001	“EXOR” mode
1000X011	“AND” mode
1000X100	“TEXT ATTRIBUTE” mode
10000XXX	internal character generator mode
10001XXX	external character generator mode

The display mode is defined by this command. The display mode doesn't change until this command is sent. Logically “OR”, “EXOR”, “AND” of text and graphic display can be displayed. When internal character generator mode is selected, character code 00H~7FH are selected from built-in character generator RM. The character code 80H~FFH are automatically selected from external character generator RAM.

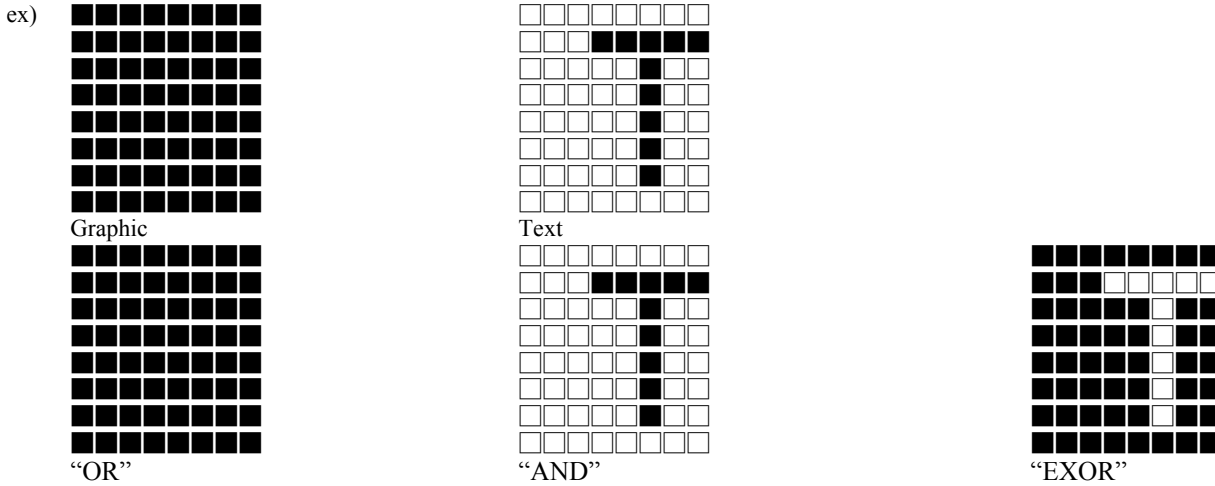

Note: Only text display is attributed, because attribute data is located in graphic RAM area.

A) Attribute function

“Reverse display”, “Character blink” and “Inhibit” are called “Attribute”. The attribute data is written in the graphic area defined by Control word set command. The mode set command selects text display only and graphic display cannot be displayed. The attribute data of the 1st character in text area is written at the 1st 1 byte in graphic area, and attribute data of n-th character is written at the n-th 1 byte in graphic area. Attribute function is defined as follows:

Attribute RAM 1 Byte				X	X	X	X	d3	d2	d1	d0
d3	d2	d1	d0	FUNCTION							
0	0	0	0	normal display							
0	1	0	1	reverse display							
0	0	1	1	inhibit display							
1	0	0	0	blink of normal display							
1	1	0	1	blink of reverse display							
1	0	1	1	blink of inhibit display							

X: don't care

10.2.4 Display mode

CODE	FUNCTION
10010000	display off
1001XX10	cursor on, blink off
1001XX11	cursor on, blink on
100101XX	text on, graphic off
100110XX	text off, graphic on
100111XX	text on, graphic on

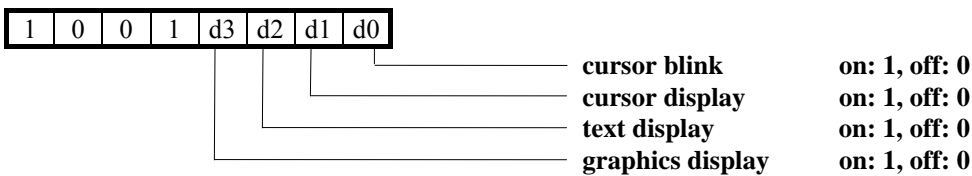

Note: It is necessary to turn on “text” display“ and ”graphic display“ in following case.

- 1) Combination of text/graphic display
- 2) Attribute function

10.2.5 Cursor pattern select

CODE	FUNCTION	CODE	FUNCTION
10100000	1 line cursor	10100100	5 lines cursor
10100001	2 lines cursor	10100101	6 lines cursor
10100010	3 lines cursor	10100110	7 lines cursor
10100011	4 lines cursor	10100111	8 lines cursor

When cursor display is ON, this command selects the cursor pattern from 1 line to 8 lines. The cursor address is defined by cursor pointer set command.

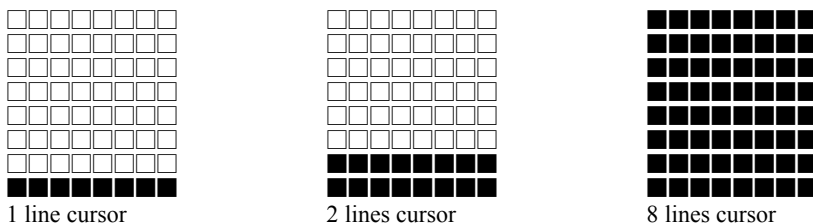

10.2.6 Data auto read/write

CODE	FUNCTION
10110000 B0H	data auto write set
10110001 B1H	data auto read set
10110010 B2H	auto reset

This command is convenient to send full screen data from external display RAM. After setting auto mode, “data write (or read)” command is not necessary between each data. “Data auto write (or read)” command should follow the “Address pointer set” and address pointer is automatically increment by +1 after each data “auto reset” is necessary to return normal operation because all data is regarded “display data” and no command can be accepted in the auto mode.

Note: Status check for auto mode (STA2, STA3 should be checked between each data. Auto reset should be performed after checking STA3=1 (STA2=1)).

Refer following flow chart.

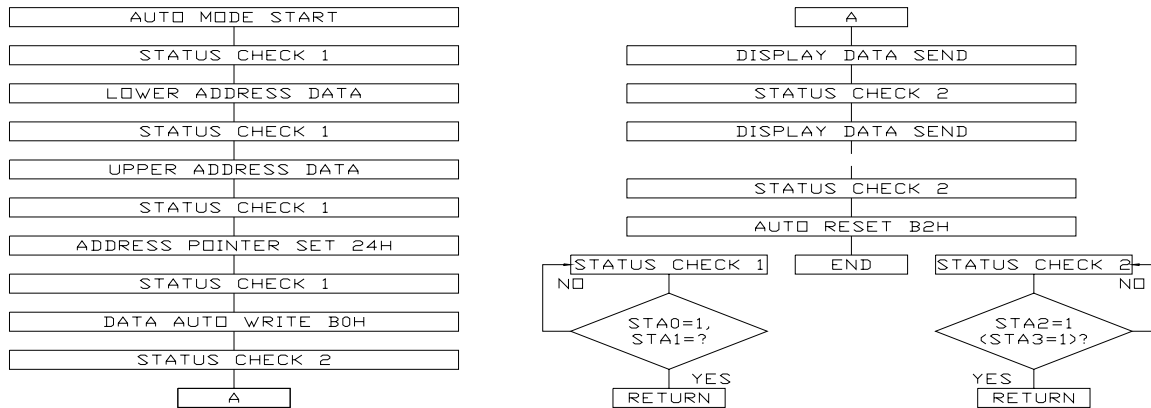

10.2.7 Data read write

CODE	FUNCTION	OPERAND
11000000 C0H	DATA WRITE AND ADP INCREMENT	data
11000001 C1H	DATA READ AND ADP INCREMENT	-
11000010 C2H	DATA WRITE AND ADP DECREMENT	data
11000011 C3H	DATA READ AND ADP DECREMENT	-
11000100 C4H	DATA WRITE AND ADP NONVARIABLE	data
11000101 C5H	DATA READ AND ADP NONVARIABLE	-

This command is used for data write from MPU to external display RAM to MPU. Data write/read should be executed after setting address by address pointer can be automatically increment or decrement by setting this command.

Note: This command is necessary for each 1 byte data. Refer following flow chart.

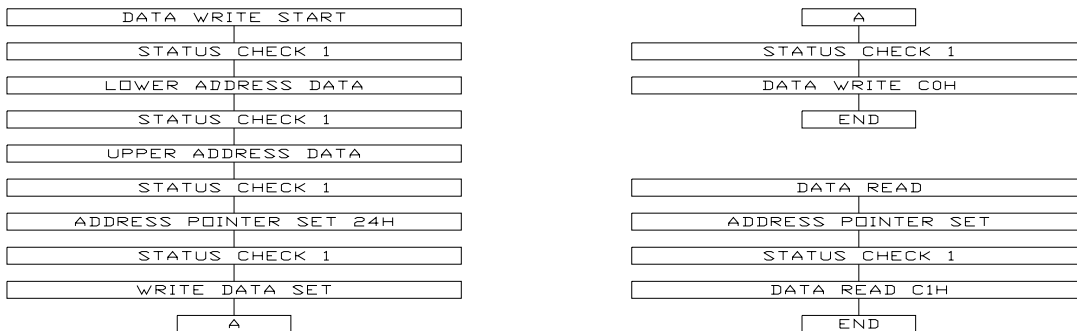

10.2.8 Screen peek

CODE	FUNCTION	OPERAND
11100000 E0H	screen peek	-

This command is used to transfer displayed 1 byte data to data stack, and this 1 byte data can be read from MPU by data access. The logical combination data of text and graphic display on LCD screen can be read by this command. The status (STA6) should be checked just after “screen peek” command. If the address command is not in graphic area, this command ignored and status flag (STA6) is set.

Refer following flow chart.

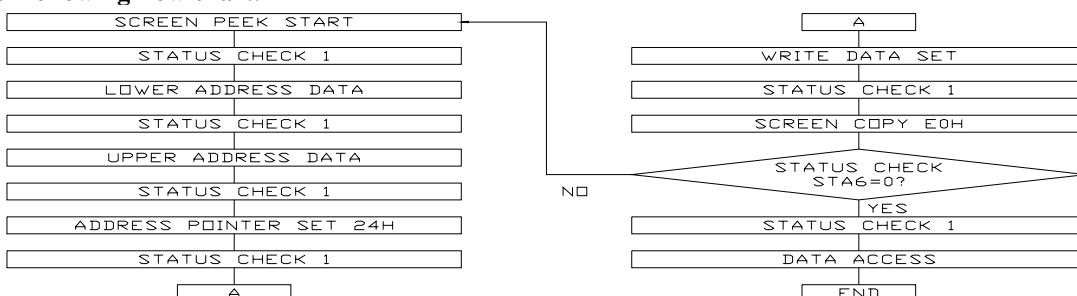

10.2.9 Screen copy

CODE	FUNCTION	OPERAND
11101000 E8H	screen copy	-

This command is used to copy displayed 1 line data to graphic area. The start point of 1 line data in the screen is determined by the address pointer.

- Note: a) When the attribute of text is used this command cannot be used. (Because attribute data is in the graphic area.)
 b) In case of 2 screen drive, this command cannot be used. (Because T6963c cannot separate upper screen data and lower screen data.)

Refer following flow chart.

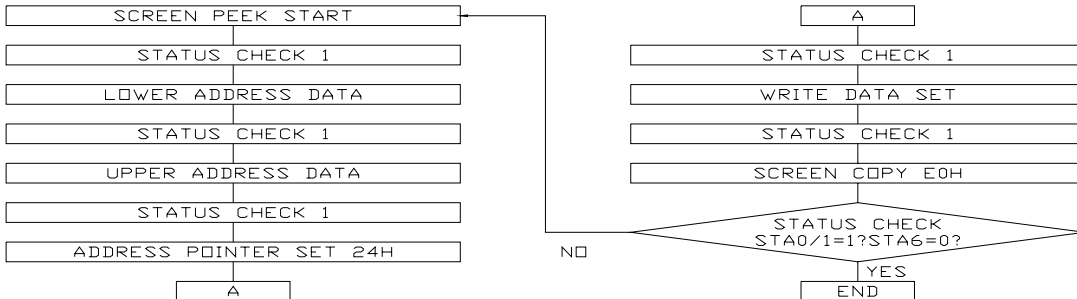

10.2.10 Bit set/reset

CODE	FUNCTION	CODE	FUNCTION
11110XXX	bit reset	1111X011	bit 3
11111XXX	bit set	1111X100	bit 4
1111X000	bit 0 (LSB)	1111X101	bit 5
1111X001	bit 1	1111X110	bit 6
1111X010	bit 2	1111X111	bit 7

This command is used to set or reset a bit of 1 byte is specified by address pointer. Plural bits in the 1 byte data cannot be set/reset at a time.

Refer following flow chart.

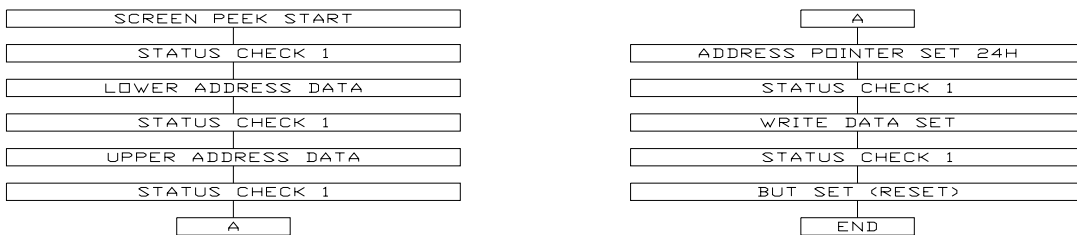

10.3 Flowchart of communications with MPU

10.3.1 Status Read

Before sending data (read/write), command it is necessary to check the status.

A) Status Check

Status of T6963C can be read from data lines.

RD= L, WR = H, CE = L, C/D = H, D0~7 -> Status word T6963C. Status word format is following.

MSB				LSB			
STA7	STA6	STA5	STA4	STA3	STA2	STA1	STA0
D7	D6	D5	D4	D3	D2	D1	D0
STA0	check capability of command execution				0: disable	1:enable	
STA1	check capability of data read/write				0: disable	1:enable	
STA2	check capability of auto mode data read				0: disable	1:enable	
STA3	check capability of auto mode data write				0: disable	1:enable	
STA4	not use						
STA5	check capability of controller operation				0: disable	1:enable	
STA6	error flag. using screen peek/copy command				0: no error		
STA7	check the condition blink				0: display off 1:normal display		

- Note: 1. It is necessary to check STA0 and STA1 at the same time. The error is happened by sending data at executing command.
 2. The status check will be enough to check STA0/STA1.
 3. The STA2/STA3 are valid in auto mode STA0/STA1 are invalid.

Status checking flow



4. It is impossible to save status check in the case of command that is MSB 0. To have the delay time cannot be save status check. The interrupt of hardware is happened at the end of lines. If command of MSB0 is sent in this period, the command executing is waited. The state of waiting is not known without to check status. The sending next command or data is disregarded or rewrites data of waiting command

10.3.2 Data Set

In T6963C, the data have been set and command executes.

The order of procedure of command sending

1) The case of 1 data

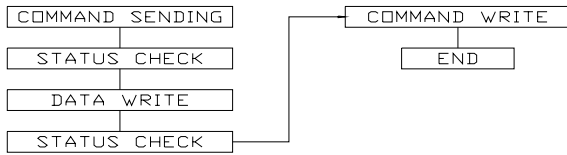

2) The case of 2 data

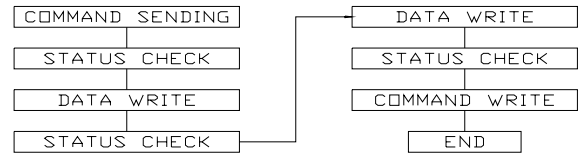

Note: In case of over 2 data sending, the last data (or last 2 data) is valid.

10.4 Initialize

Initialize of controller LSI T6963C is required for “Mode set”, “Control word set” after power on. Following is the one example of initialize procedure of 240x64 dots display (In case of 6x8 dots/font).

Command	C/D	D7 -----D0	Note
Power on			Power on
Hard reset (use reset terminal)			RESET=“L” (1msec minimum after VDD>4.75V)
Mode set	1	1 0 0 0 0 0 0 0	“OR” mode
Control word set			
Graphic home position set (Graphic home position 000H)	0	0 0 0 0 0 0 0 0	graphic home address
	0	0 0 0 0 0 0 0 0	
	1	0 1 0 0 0 0 1 0	command
Number of graphic area set (Graphic 40x6 dots)	0	0 0 1 0 1 0 0 0	number of area
	0	0 0 0 0 0 0 0 0	
	1	0 1 0 0 0 0 1 1	command
Text home position set (Text home position 1000H)	0	0 0 0 0 0 0 0 0	text home address
	0	0 0 0 1 0 0 0 0	
	1	0 1 0 0 0 0 0 0	command
Number of text area set (text 40 column)	0	0 0 1 0 1 0 0 0	number of area
	0	0 0 0 0 0 0 0 0	
	1	0 1 0 0 0 0 0 1	command
Initialize end , Data Write			
Address pointer set (address pointer 0000H)	0	0 0 0 0 0 0 0 0	graphic home address
	0	0 0 0 0 0 0 0 0	
	1	0 0 1 0 0 1 0 0	command
Data Write (graphic)	0	0 1 0 1 0 1 0 1	Data
	1	1 1 1 0 0 0 0 0	command
	0	1 0 1 0 1 0 1 0	Data
	1	1 1 1 0 0 0 0 0	command
	x	x x x x x x x x	
Address pointer set (address pointer 1000H)	0	0 0 0 0 0 0 0 0	text home address
	0	0 0 0 1 0 0 0 0	
	1	0 0 1 0 0 1 0 0	command
Data write (text)	0	0 0 1 1 0 1 0 0	Data
	1	1 1 0 0 0 0 0 0	command
	0	0 0 1 0 1 1 1 1	Data
	1	1 1 0 0 0 0 0 0	command
	x	x x x x x x x x	
Display Mode Set (text/graphic on)	1	1 0 0 1 1 1 0 0	

Note 1: “status check” should be inserted between all command and data.

2: Display mode set register is cleared (no display mode) by the hard reset , and no display is appeared on LCD panel. And just after “Display Mode set 9CH”, written data is display on the LCD.

11. CG ROM PATTERN

LSB MSB	0	1	2	3	4	5	6	7	8	9	A	B	C	D	E	F
0	0	1	2	3	4	5	6	7	8	9	A	B	C	D	E	F
1	0	1	2	3	4	5	6	7	8	9	:	:	<	=	>	?
2	0	A	B	C	D	E	F	G	H	I	J	K	L	M	N	O
3	P	Q	R	S	T	U	V	W	X	Y	Z	[\]	^	_
4	~	a	b	c	d	e	f	g	h	i	j	k	l	m	n	o
5	p	q	r	s	t	u	v	w	x	y	z	{		}	~	
6	0	1	2	3	4	5	6	7	8	9	A	B	C	D	E	F
7	0	1	2	3	4	5	6	7	8	9	A	B	C	D	E	F

12. Functional Test & Inspection Criteria

12.1 Sample plan

Sample plan according to MIL-STD-105D level 2, and acceptance/rejection criteria is.

Base on : Major defect : AQL 0.65 Minor defect : AQL 2.5

12.2 Inspection condition

Viewing distance for cosmetic inspection is 30cm with bare eyes, and under an environment of 800 lus (20W) light intensity. All direction for inspecting the sample should be within 45° against perpendicular line.

12.3 Definition of Inspection Zone in LCD

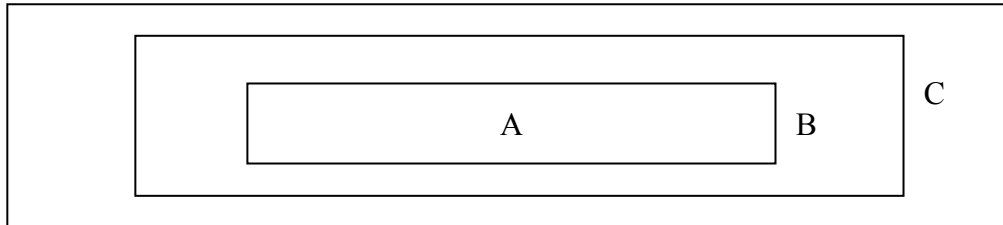

Zone A : Character / Digit area

Zone B : Viewing area except Zone A (Zone A + Zone B = minimum Viewing area)

Zone C : Outside viewing area (invisible area after assembly in customer's product)

Note : As a general rule, visual defects in Zone C are permissible, when it is no trouble for quality and assembly of customer's product.

12.4 Major Defect

All functional defects such as open (or missing segment), short, contrast differential, excess power consumption, smearing, leakage, etc. and overall outline dimension beyond the drawing. Are classified as major defects.

12.5 Inspection Parameters And Glass Pixel(偏光板和玻璃圖像檢驗)

No	Polarizer (偏光片)	Criteria		
1	Black or White spots and Piercing (黑/白點和刺孔)	Dimension (面積)		
		Acceptable number (可接受數量)		
		$D \leq 0.15$	*	
		$0.15 < D \leq 0.2$	6	
		$0.2 < D \leq 0.3$	2	
		$0.3 < D$	0	
D[面積]=(Length[長度]+Width[寬度])/2 * : Disregard(忽略)				
2	Scratch (刮傷)	X(mm)	Y(mm)	Acceptable number (可接受數量)
		*	$0.04 \geq W$	*
		$3.0 \geq L$	$0.06 \geq W$	4
		$2.0 \geq L$	$0.08 \geq W$	2
		--	$0.10 \geq W$	0
X : Length[長度] Y : Width[寬度] * : Disregard(忽略)				
3	Air Bubbles (between glass & polarizer) 氣泡 (玻璃跟偏光板之間)	Dimension (面積)		
		Acceptable number (可接受數量)		
		$D \leq 0.15$		
		$0.15 < D \leq 0.25$		
		$0.25 < D$		
* : Disregard(忽略)				

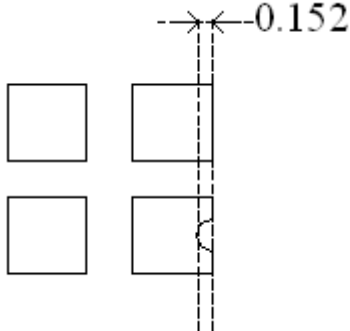
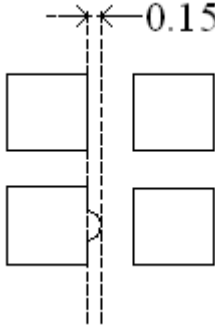
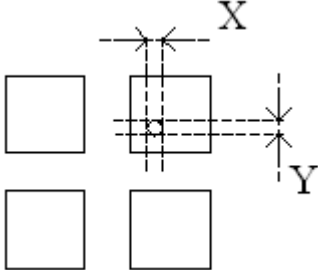
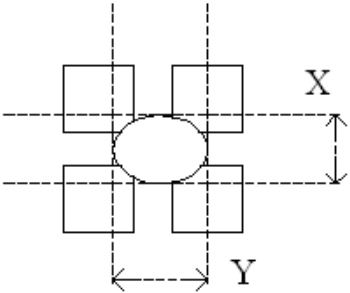
<p>4</p>	<p>Glass of Pixel (玻璃的圖像)</p>	<p>(1)Pixel shape (with Dent)/圖像凹度</p>  <p>•Less than 0.152 mm is no counted (小於 0.152mm 者不計)</p> <p>(2)Pixel shape (with Projection)/圖像凹度</p>  <p>Should not be connected next pixel (點與點間不可先連接)</p> <p>(3)Deformation/變形</p>  <p>$(X + Y) / 2 \leq 0.15\text{mm}$ •Less than 0.1 mm is no counted (小於 0.15mm 者不計)</p> <p>(4) Deformation/變形</p>  <p>$(X + Y) / 2 \leq 0.3\text{mm}$ •Less than 0.3 mm is no counted (小於 0.3mm 者不計)</p>
----------	-----------------------------------	---

13. Reliability Test (測試條件) – Normal Temperature (常溫)

No change no display and in operation under the following text condition.

(在不改變原先顯示下進行以下測試操作)

Conditions : Unless otherwise specified, test will be conducted under the following condition.

Temperature : $20\pm 5^{\circ}\text{C}$

Humidity : $40\pm 5\%\text{RH}$

Tests will be not conducted under functioning state.

(條件：除非其他特殊情況，否則測試將以溫度： $20\pm 5^{\circ}\text{C}$ ，濕度： $40\pm 5\%\text{RH}$ 為主)

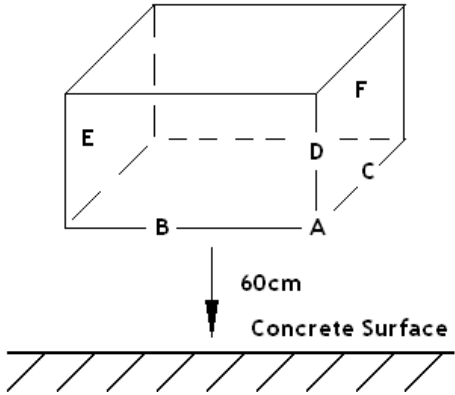
NO	Parameter	Conditions	Notes
1	High Temperature Operating	$50^{\circ}\text{C}\pm 2^{\circ}\text{C}$, 96 hrs (operation state) (96 小時，溫度 $50^{\circ}\text{C}\pm 2^{\circ}\text{C}$ 電源開啟的操作情況下)	
2	Low Temperature Operating	$0^{\circ}\text{C}\pm 2^{\circ}\text{C}$, 96 hrs (operation state) (96 小時，溫度 $0^{\circ}\text{C}\pm 2^{\circ}\text{C}$ 電源開啟的操作情況下)	1
3	High Temperature Storage	$60^{\circ}\text{C}\pm 2^{\circ}\text{C}$, 96 hrs (96 小時，溫度 $60^{\circ}\text{C}\pm 2^{\circ}\text{C}$ 電源關閉靜態操作下)	2
4	Low Temperature Storage	$-10^{\circ}\text{C}\pm 2^{\circ}\text{C}$, 96 hrs (96 小時，溫度 $-10^{\circ}\text{C}\pm 2^{\circ}\text{C}$ 電源關閉靜態操作下)	1, 2
5	Damp Proof Test	$40^{\circ}\text{C}\pm 2^{\circ}\text{C}$, $85\sim 90\%\text{RH}$, 96hr (96 小時，溫度： $40^{\circ}\text{C}\pm 2^{\circ}\text{C}$ ，濕度： $85\sim 90\%\text{RH}$ 電源關閉靜態操作下)	1, 2
6	Vibration Test	Total fixed amplitude : 1.5 mm (完全固定輻射：1.5mm) Vibration Frequency : 10 ~ 55 Hz (震動頻率：10~55 Hz) One cycle 60 seconds to 3 directions of X, Y, Z for each 15 minutes (每一個循環 X, Y, Z 軸方向各做 60 秒，連續做 5 次，共計 15 分鐘)	3
7	Shock Test	To be measured after dropping from 60cm high on the concrete surface in packing state. (包裝材從 60 公分高的地方向地面落下)  Dropping method comer dropping (角落落下方式) A comer : once Edge dropping (側邊落下) B, C, D edge : once Face dropping (表面落下) E, F, G face : once	

Note 1 : No dew condensation to be observed. (不要在”水氣凝結點”下觀察)

Note 2 : The function test shall be conducted after 4 hours storage at the normal

Temperature and humidity after removed from the test chamber

(從實驗室移出後，放在一般常溫 (溫度： 25°C ，濕度： $45\%\text{RH}$)，

且四小時後通電流或電壓，看它是否能正常動作)

Note 3 : Vibration test will be conducted to the product itself without putting it in a container.

(在震動測試下，產品本身不需容器即能自行傳導)

14. Reliability Test (測試條件) – Wide Temperature (廣溫)

No change no display and in operation under the following text condition.

(在不改變原先顯示下進行以下測試操作)

Conditions : Unless otherwise specified, test will be conducted under the following condition.

Temperature : $20\pm 5\text{ }^{\circ}\text{C}$

Humidity : $40\pm 5\%\text{RH}$

Tests will be not conducted under functioning state.

(條件：除非其他特殊情況，否則測試將以溫度： $20\pm 5\text{ }^{\circ}\text{C}$ ，濕度： $40\pm 5\%\text{RH}$ 為主)

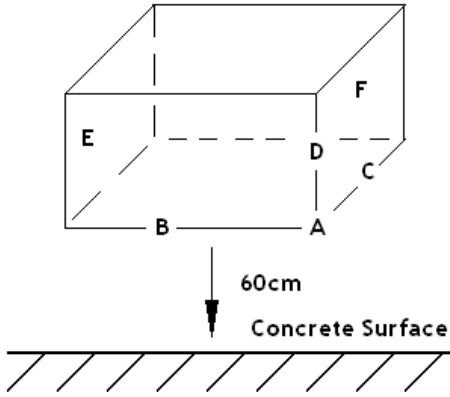
NO	Parameter	Conditions	Notes
1	High Temperature Operating	$70^{\circ}\text{C}\pm 2\text{ }^{\circ}\text{C}$, 96 hrs (operation state) (96 小時，溫度 $70^{\circ}\text{C}\pm 2\text{ }^{\circ}\text{C}$ 電源開啟的操作情況下)	
2	Low Temperature Operating	$-20^{\circ}\text{C}\pm 2\text{ }^{\circ}\text{C}$, 96 hrs (operation state) (96 小時，溫度 $-20^{\circ}\text{C}\pm 2\text{ }^{\circ}\text{C}$ 電源開啟的操作情況下)	1
3	High Temperature Storage	$80^{\circ}\text{C}\pm 2\text{ }^{\circ}\text{C}$, 96 hrs (96 小時，溫度 $80^{\circ}\text{C}\pm 2\text{ }^{\circ}\text{C}$ 電源關閉靜態操作下)	2
4	Low Temperature Storage	$-30^{\circ}\text{C}\pm 2\text{ }^{\circ}\text{C}$, 96 hrs (96 小時，溫度 $-30^{\circ}\text{C}\pm 2\text{ }^{\circ}\text{C}$ 電源關閉靜態操作下)	1, 2
5	Damp Proof Test	$40^{\circ}\text{C}\pm 2\text{ }^{\circ}\text{C}$, $85\sim 90\%\text{RH}$, 96hr (96 小時，溫度： $40^{\circ}\text{C}\pm 2\text{ }^{\circ}\text{C}$ ，濕度： $85\sim 90\%\text{RH}$ 電源關閉靜態操作下)	1, 2
6	Vibration Test	Total fixed amplitude : 1.5 mm (完全固定輻射：1.5mm) Vibration Frequency : 10 ~ 55 Hz (震動頻率：10~55 Hz) One cycle 60 seconds to 3 directions of X, Y, Z for each 15 minutes (每一個循環 X, Y, Z 軸方向各做 60 秒，連續做 5 次，共計 15 分鐘)	3
7	Shock Test	To be measured after dropping from 60cm high on the concrete surface in packing state. (包裝材從 60 公分高的地方向地面落下)  Dropping method comer dropping (角落落下方式) A comer : once Edge dropping (側邊落下) B, C, D edge : once Face dropping (表面落下) E, F, G face : once	

Note 1 : No dew condensation to be observed. (不要在”水氣凝結點”下觀察)

Note 2 : The function test shall be conducted after 4 hours storage at the normal

Temperature and humidity after removed from the test chamber

(從實驗室移出後，放在一般常溫 (溫度： 25°C ，濕度： $45\%\text{RH}$)，

且四小時後通電流或電壓，看它是否能正常動作)

Note 3 : Vibration test will be conducted to the product itself without putting it in a container.

(在震動測試下，產品本身不需容器即能自行傳導)

15. Precautions Against Product Handling [產品使用注意事項]：

The following precautions will guide you in handling our product correctly.

[下列警戒引導正確地使用產品]

15.1 Care of the LCD module against static electricity discharge. [LCD 模組靜電注意事項]

15.1.1 When working with the module, be sure to ground your body and any electrical equipment you may be using. We strongly recommend the use of anti static mats (made of rubber), to protect work tables against the hazards of electrical shock.

[操作模組時，避免操作者身體接地及任何造成靜電的設備同時使用，強烈建議(橡膠製)抗靜電墊的使用，以免工作台面遭受到電氣干擾]

15.1.2 Slowly and carefully remove the protective film from the LCD module, since this operation can generate static electricity.

[緩慢小心地移除 LCD 模組上的保護膜，以防靜電產生]

15.1.3 Avoid the use of work clothing made of synthetic fibers. We recommend cotton clothing or other conductivity-treated fibers.

[避免穿著人造合成的工作服，建議棉質或是有傳導性的纖維質料]

15.2 Liquid crystal display devices (LCD devices) [液晶螢幕顯示器的組成]

15.2.1 The polarizer adhering to the surface of the LCD is made of a soft material.

Guard against scratching it. [偏光板是軟性原料製成，請勿刮傷]

15.2.2 The LCD device panel used in the LCM is made of plate glass. Avoid any strong mechanical shock. Should the glass break handle it with care.

[模組使用的玻璃為平面玻璃，避免任何強烈的機械撞擊，且觸碰時請小心]

15.3 When the LCD module alone must be stored form long periods of time

[當 LCD 模組須長時間存放時]

15.3.1 Protect the modules from excessive external forces. [避免外力壓迫]

15.3.2 Protect the modules from high temperature and humidity. [避免處於高溫高濕下]

15.3.3 Keep the modules out of direct sunlight or direct exposure to ultraviolet rays.

[遠離陽光曝曬或直接曝露在紫外線下]

15.4 Use the module with a power supply that is equipped with an overcurrent protector circuit, since the module is not provided with this protective feature.

[因為模組本身沒有防護，所以模組的供應器應配有過高電流的保護迴路]

15.5 Do not ingest the LCD fluid itself should it leak out of a damaged LCD module. Should hands or clothing come in contact with LCD fluid, wash immediately with soap.

[LCD 破裂液晶外漏時，切勿食下液晶；若手或衣服接觸到液晶，請立刻用肥皂清洗]

15.6 Conductivity is not guaranteed for models that use metal holders where solder connections between the metal holder and the PCB are not used. Please contact us to discuss appropriate ways to assure conductivity.

[當金屬框並沒焊接於 PCB 板上時，無法保證使用金屬框是具有傳導性，請連絡我們商討適當方式傳導]

15.7 For models which use CCFL [CCFL 的模組]:

15.7.1 High voltage of 1000V or greater is applied to the CCFL cable connector area.

[CCFL 排線連接器用於 1000V 以上的高電壓]

15.7.2 Protect CCFL cables from rubbing against the unit and thus causing the wire jacket to become worn. [CCFL 排線必須有保護 CCFL 與模組磨擦，以防 CCFL 外殼受到損害]

15.7.3 The use of CCFLs for extended periods of time at low temperatures will significantly shorten their service life. [長時間低溫使用 CCFL 會明顯縮減其使用壽命]

15.8 For models which use touch panels [觸控式面板模組]:

15.8.1 Do not stack up modules since they can be damaged by components on neighboring modules.
[勿堆疊模組以防損壞]

15.8.2 Do not place heavy objects on top of the product. This could cause glass breakage.
[勿將重物放置在產品上，會導致玻璃破損]

15.9 For models which use COG & TAB [COG 及 TAB 模組]:

15.9.1 The mechanical strength of the product is low since the IC chip is faces out unprotected from the rear. Be sure to protect the rear of the IC chip from external forces.
[由於 IC 晶片表面無防護，所以抗壓力有限，須加強保護以防外力]

15.9.2 Given the fact that the rear of the IC chip is left exposed, in order to protect the unit from electrical damage, avoid installation configurations in which the rear of the IC chip runs the risk of making any electrical contact.
[勿暴露 IC 晶片以防電氣干擾，且避免安裝 IC 時有任何電子接觸]

15.10 Models which use flexible cable, heat seal, or TAB [加有軟排線、熱封條或 TAB 的模組]:

15.10.1 In order to maintain reliability, do not touch or hold by the connector area.
[以維持產品信賴度，請勿觸碰或握住連接器]

15.10.2 Avoid any bending, pulling, or other excessive force, which can result in broken connections. [避免彎曲、拉扯或過度力量，會造成連接器損壞]

15.11 In case of acrylic plate is attached to front side of LCD panel, cloudiness (very small cracks) can occur on acrylic plate, being influenced by some components generated from polarizer film.

Please check and evaluate those acrylic materials carefully before use.

[貼在 LCD 玻璃前面的壓克力板若有模糊情況(微小裂縫)，即會影響偏光板；使用前請仔細確認壓克力材質]

15.12 In case of buffer material such as cushion/gasket is assembled into LCD module, it may have an adverse effect on connecting parts (LCD panel-TCP/ HEAT SEAL/ FPC, PCB-TCP/HEAT SEAL/FPC, TCP-HEAT SEAL, TCP-FPC, HEAT SEAL-FPC) depending on its materials.

Please check and evaluate these materials carefully before use.

[緩衝原料像是減震墊/襯墊，或許會對連接器(LCD panel-TCP/ HEAT SEAL/ FPC, PCB-TCP/HEAT SEAL/FPC, TCP-HEAT SEAL, TCP-FPC, HEAT SEAL-FPC)造成反效果，使用前請仔細確認材料]

16. Warranty [保證]:

This product has been manufactured to your company's specifications as a part for use in your company's general electronic products. It is guaranteed to perform according to delivery specifications. For any other use apart from general electronic equipment, we cannot take responsibility if the product is used in medical devices, nuclear power control equipment, aerospace equipment, fire and security systems, or any other applications in which there is a direct risk to human life and where extremely high levels of reliability are required. If the product is to be used in any of the above applications, we will need to enter into a separate product liability agreement.

[此產品的製造是依照客戶的規格，被使用於客戶的一般電子產品上，保證產品製作根據出貨的規格，若產品的使用不是在一般電子設備，而組裝於下列產品上則無法受理（如醫療產品、核心電源控制設備、航空設備、防火及保全系統，或任何相關儀器會直接影響人類生命等），若模組使用於上述的儀器，則需商討各別產品責任義務的協定]

- 16.1 We cannot accept responsibility for any defect, which may arise after the application of strong external force to the product.
[不受理因強大外力衝擊造成產品的缺陷]
- 16.2 We cannot accept responsibility for any defect, which may arise from additional manufacturing of the product (including disassembly and reassembly), after product delivery.
[不受理產品出貨後，因額外加工(包含拆裝及重新封包)造成的缺陷]
- 16.3 We cannot accept responsibility for any defect, which may arise due to the application of static electricity after the product, has passed your company's acceptance inspection procedures.
[不受理通過貴公司檢驗流程後，由於靜電造成產品的缺陷]
- 16.4 We cannot accept responsibility for intellectual property of a third party, which may arise through the application of our product to your assembly with exception to those issues relating directly to the structure or method of manufacturing of our product.
[不受理因在客戶產品生產線端所產生的第三人智慧財產權責任，除非與我司生產製造方法有直接關係的問題]
- 16.5 When the product is in CCFL models, CCFL service life and brightness will vary according to the performance of the inverter used, leaks, etc. We cannot accept responsibility for product performance, reliability, or defect, which may arise.
[產品是 CCFL 模組時，CCFL 的壽命及亮度將取決於連接器的性能、漏電量等；無法受理因 CCFL 造成產品性能的缺陷]
- 16.6 SDEC will not be held responsible for any quality guarantee issue for defect products longer than 1(one) year from SDEC production which ever comes later.
[出廠超過一年的瑕疵品，任何品質擔保則不受理]