

# 飞优特科技（深圳）有限公司

FUTURE S&T(SHEN ZHEN)CO.,LTD

## Approval Sheet

Customer : \_\_\_\_\_ Part No.: FB20411-YGBW

Sample Approved: \_\_\_\_\_ Sample Quantity: \_\_\_\_\_

Sample Date: \_\_\_\_\_

### 1:Outlook

Items	Description	Result	
Outer Dimension	Length、Width、Height、Positioning Hole、I/O Position	<input type="checkbox"/> OK	<input type="checkbox"/> NG
LCD Color	LCD Background Color	<input type="checkbox"/> OK	<input type="checkbox"/> NG
LED Color	LED Lighting Color	<input type="checkbox"/> OK	<input type="checkbox"/> NG
Others	Customer Additional Request	<input type="checkbox"/> OK	<input type="checkbox"/> NG
Outlook Description:			

### 2:Electrical Characteristics

Items	Description	Result	
LCD Voltage	LCD Driving Voltage:VLCD	<input type="checkbox"/> OK	<input type="checkbox"/> NG
Viewing Angle	LCD Operating Viewing Angle	<input type="checkbox"/> OK	<input type="checkbox"/> NG
LCM Current Consumption	LCM current consumption satisfy customer request	<input type="checkbox"/> OK	<input type="checkbox"/> NG
LED Current Consumption	LED lighting Current Consumption satisfy customer request	<input type="checkbox"/> OK	<input type="checkbox"/> NG
Electrical Characteristics Description:			

Conclusion:  **Can go to M/P according to samples**  
 **Need to be revised according to above description**

<b>Approved</b> <b>By:</b>		<b>Verified</b> <b>By:</b>	
-------------------------------	--	-------------------------------	--



## CONTENTS

1 FUNCTION & FEATURES .....	1
2 BLOCK DIAGRAM.....	1
3 DIMENSIONAL CD DRAWING .....	2
4 POWER SUPPL .....	3
5 PIN DESCRIPTION .....	3
6 MAXIMUM ABSOLUTE LIMIT (T=25°C) .....	4
7 ELECTRICAL CHARACTERISTICS .....	4
7.1DC Characteristics(T=25°C) .....	4
7.2 AC Characteristics .....	5
8 Instruction Description .....	8
9 QUALITY SPECIFICATIONS.....	10
9.1 Defect classification.....	10
9.2 Note on defect classification.....	11
9.3. Reliability of LCM.....	17
10.DESCRIBE TO THE PART NO: .....	17
11.GUARRANTEE .....	17
12. CHARACTER PATTERN .....	18

## 1 FUNCTION & FEATURES

ITEM	Normal dimensions
Display Format	20Characters*4 Lines
Module dimension	146.0(W)*62.5(H)* 13.5 (T_MAX) mm
Viewing area	123.5 (W)*43.0(H) mm
Duty/bias	1/16Duty,1/5Bias
LCD mode	Y-G STN/Positive /Transflective
Viewing direction	6:00 O'clock

## 2 BLOCK DIAGRAM

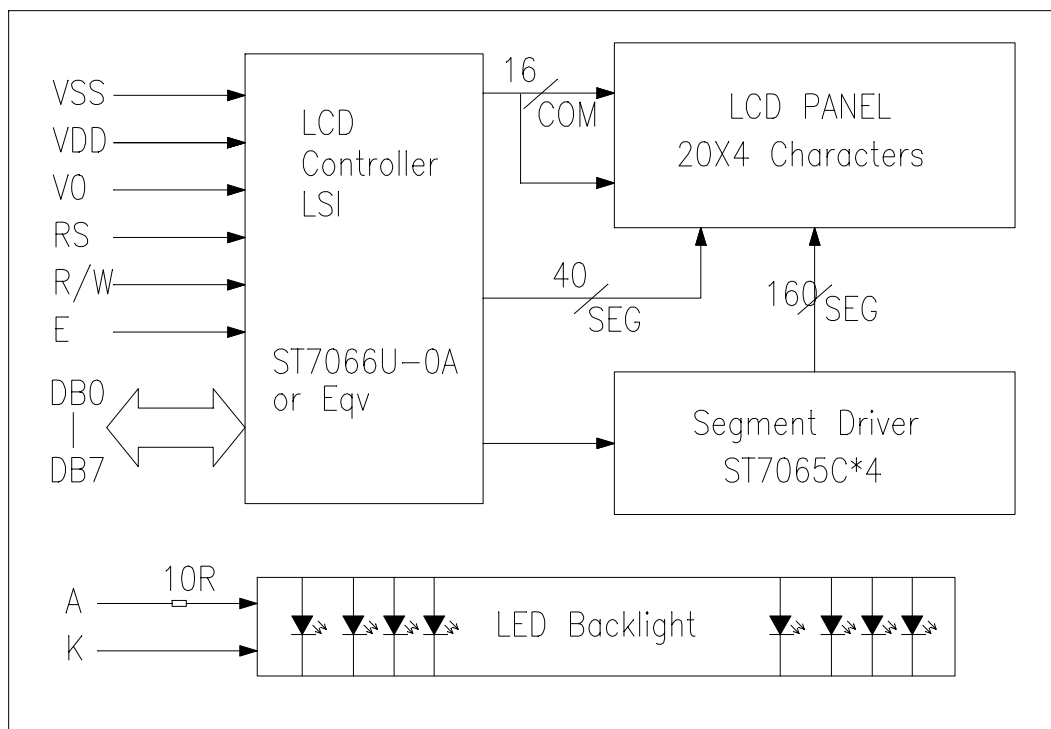

# 3 DIMENSIONAL CD DRAWING

Customer No. :	Customer Approve By:	REV. A0	DESCRIPTION OF MODIFY 1' ST DESIGN	MODIFY BY: DZH	DATE 2015-11-30
----------------	----------------------	---------	---------------------------------------	-------------------	--------------------



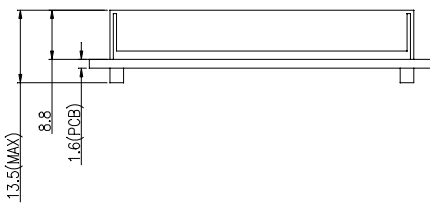

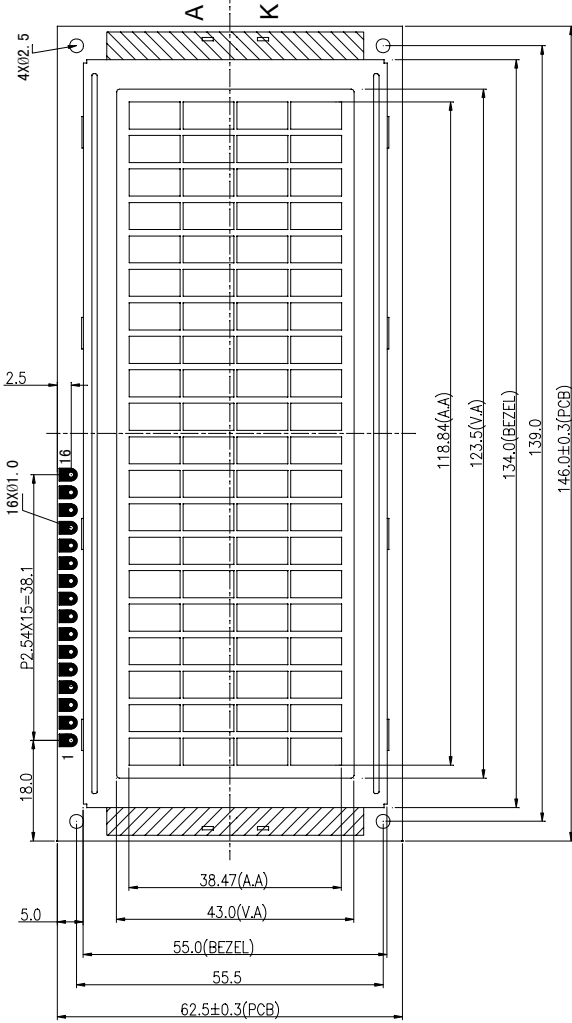

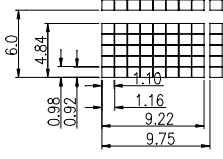

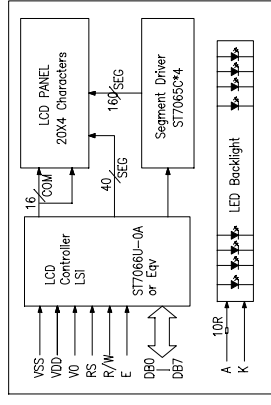
PIN FUNCTION:

PIN NO	1	2	3	4	5	6	7	8
SYMBOL	VSS	VDD	V0	RS	R/W	E	DB0	DB1
PIN NO	9	10	11	12	13	14	15	16
SYMBOL	DB2	DB3	DB4	DB5	DB6	DB7	A	K

Note:

1. Display Mode: Y-G STN/POSITIVE/TRANSFLECTIVE
2. Driving Condition: 1/16Duty, 1/5Bias; VDD=5.0V, VLCD=4.7V
3. Viewing Direction: 6:00 o'clock
4. Operating Temp: -20~+70°C
5. Storage Temp: -30~+80°C
6. LCD Connector: COB/Driver IC: ST7066U-0A+ST7065C\*4
7. Backlight: White Edge/(4\*2LED); Vf=5.0V
8. Dimensions with mark "()" are referenced.
9. Unspecified tolerance is ±0.20mm
10. ROHS Request

<b>飞优特科技(深圳)有限公司</b> FUTURE S&T (SHEN ZHEN) CO., LTD TEL: +86-755-29675886, FAX: +86-755-29675655 E-mail: sales@futurelcd.com	CD	UNIT: MM	SIZE: A4
LCM NO. : FB20411-YGBW	DWG NO. : FB20411-YGBW-CD	SHEET: 1	OF 1
DRAWN BY :	CHECKED BY :	REV: A0	APPROVED BY :

## 4 POWER SUPPL

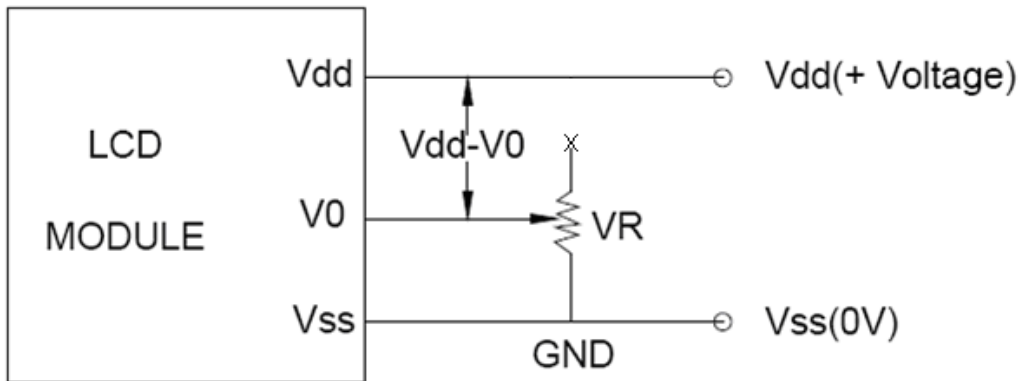

Vdd - V0: LCD Driving Voltage

VR: 10K - 20K

## 5 PIN DESCRIPTION

PIN	SYMBOL	FUNCTION
1	Vss	Power Supply(0V,GND)
2	Vdd	Power Supply For Logic(+5.0V)
3	Vo	Contrast Adjust
4	RS	Instruction/Data Register Select
5	R/W	Data Read/Write
6	E	Enable Signal
7-14	DB0-DB7	Data Bus Line
15	A	Power Supply For LED BL(+5.0V)
16	K	Power Supply For LED BL(0V,GND)

## 6 MAXIMUM ABSOLUTE LIMIT (T=25°C)

Item	Symbol	Standard value	Unit
Supply voltage	V <sub>DD</sub>	0 ∞ +7.0	V
Input voltage	V <sub>LCD</sub>	0 ∞ 11.5	V
Operating temperature	Topr	-20~+70	°C
Storage temperature	Tstg	-30~+80	°C

Note: Voltage greater than above may damage the module.All voltages are specified relative to VSS=0V.

## 7 ELECTRICAL CHARACTERISTICS

### 7.1DC Characteristics(T=25°C)

Item	Symbol	Min	Typ	Max	Unit	Applicable terminal	Test condition
LCD logic circuit supply voltage	V <sub>DD</sub>	4.5	5.0	5.5	V	-	Ta=25°C
LCD supply current	I <sub>DD</sub>	-	1	3	mA	-	
LCD input voltage	V <sub>IL</sub>	0	-	0.6	V	-	
	V <sub>IH</sub>	0.7 V <sub>DD</sub>	-	V <sub>DD</sub>	V		
LCD output voltage	V <sub>OL</sub>	-	-	0.2 V <sub>DD</sub>	V	-	
	V <sub>OH</sub>	0.75 V <sub>DD</sub>	-	-	V		
LCD driving voltage	V <sub>LCD</sub>	4.4	4.7	5.0	V	VDD-V0	
Backlight supply voltage	V <sub>AK</sub>	4.7	5.0	5.3	V	A-K	
*Backlight supply current	I <sub>f</sub>	20	90	140	mA	-	
*Peak forward current(B/L) 1 msec pulse 10% Duty Cycle	I <sub>fp</sub>			480	mA		
*Power dissipation(B/L)	P <sub>d</sub>			462	mW		

\*For operation above 25°C, the I<sub>f</sub>, I<sub>fp</sub>&P<sub>d</sub> must be derated, the current derating is -2.88mA/°C for DC drive and -6.88mA/°C for pulse drive,the power dissipation is -5.58 mW / °C.The Backlight working current must not more than 60% of the I<sub>fmax</sub> or I<sub>fpmax</sub> according to the working temperature.

## 7.2 AC Characteristics

- Writing data from MPU to ST7066U

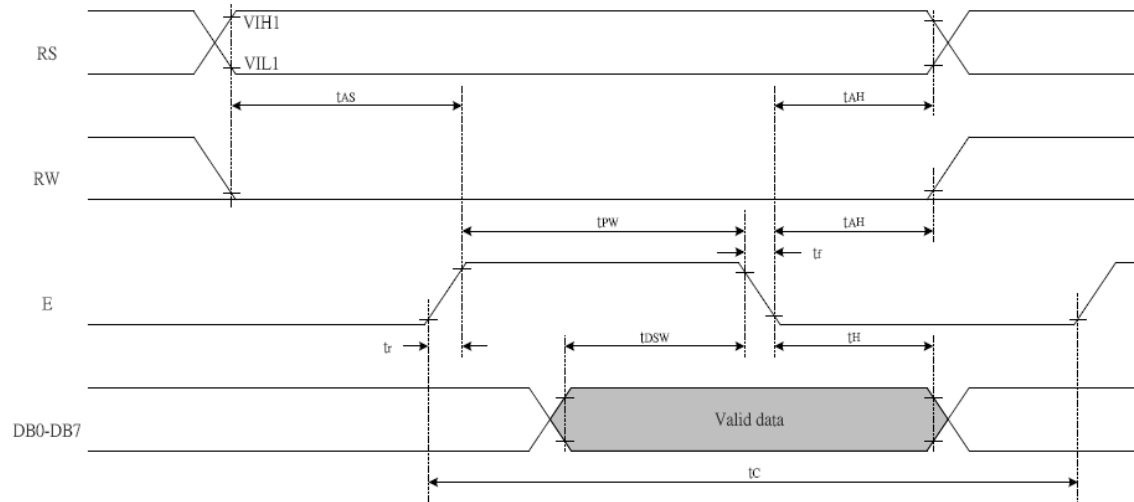

- Reading data from ST7066U to MPU

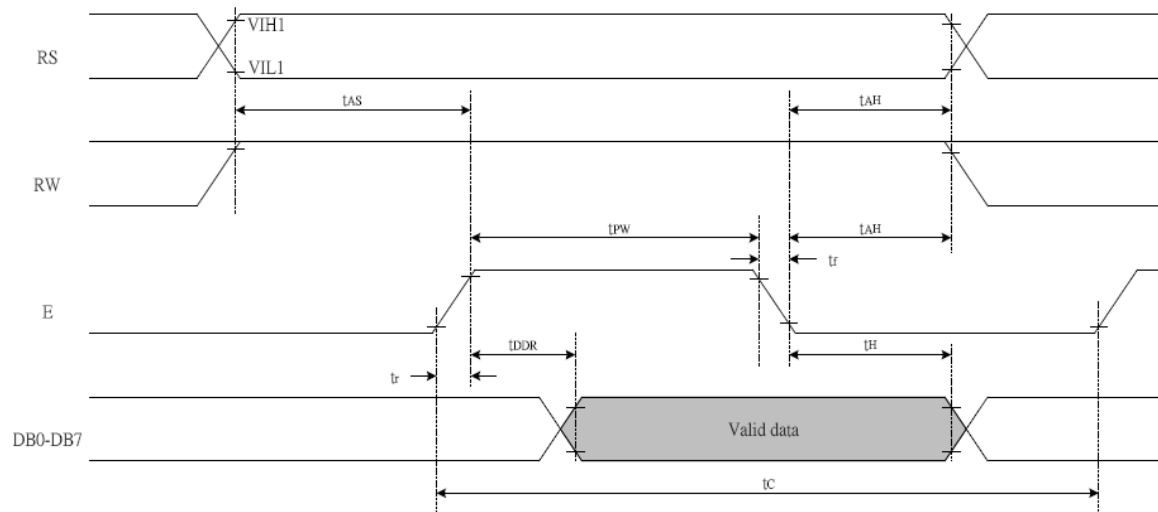



## ■ Power Supply Conditions

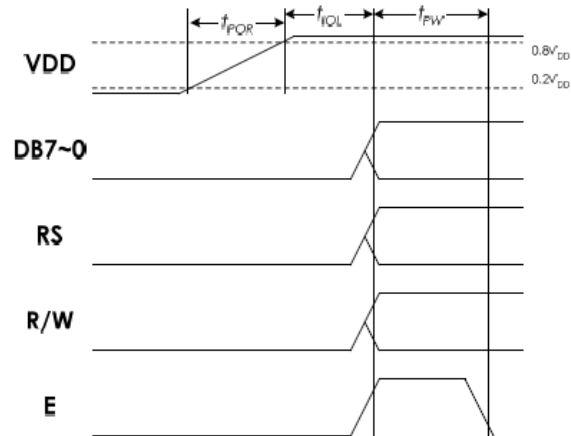

Symbol	Characteristics	Description	Min.	Typ.	Max.	Unit
tPOR	Power rise time	Power rise time that will trigger internal power on reset circuit	0.1		100	ms
tIOL	I/O Low time	The period that I/O is kept low.	40			ms
tPW	Enable pulse width	Please refer to the following tables.				

1. During tPOR, VDD noise should be reduced (especially close to 2.0V). Otherwise the Power-ON-Reset function might be triggered several times and maybe cause unexpected result.
2. During tIOL, the I/O ports of the interface (control and data signals) should be kept at "Low".

Symbol	Characteristics	Test Condition	Min.	Typ.	Max.	Unit
<i>Internal Clock Operation</i>						
f <sub>OSC</sub>	OSC Frequency	R = 91KΩ	190	270	350	KHz
<i>External Clock Operation</i>						
f <sub>EX</sub>	External Frequency	-	125	270	410	KHz
	Duty Cycle	-	45	50	55	%
T <sub>R</sub> ,T <sub>F</sub>	Rise/Fall Time	-	-	-	0.2	μs
<i>Write Mode (Writing data from MPU to ST7066U)</i>						
T <sub>C</sub>	Enable Cycle Time	Pin E	1200	-	-	ns
T <sub>PW</sub>	Enable Pulse Width	Pin E	140	-	-	ns
T <sub>R</sub> ,T <sub>F</sub>	Enable Rise/Fall Time	Pin E	-	-	25	ns
T <sub>AS</sub>	Address Setup Time	Pins: RS,RW,E	0	-	-	ns
T <sub>AH</sub>	Address Hold Time	Pins: RS,RW,E	10	-	-	ns
T <sub>DSW</sub>	Data Setup Time	Pins: DB0 - DB7	40	-	-	ns
T <sub>H</sub>	Data Hold Time	Pins: DB0 - DB7	10	-	-	ns
<i>Read Mode (Reading Data from ST7066U to MPU)</i>						
T <sub>C</sub>	Enable Cycle Time	Pin E	1200	-	-	ns
T <sub>PW</sub>	Enable Pulse Width	Pin E	140	-	-	ns
T <sub>R</sub> ,T <sub>F</sub>	Enable Rise/Fall Time	Pin E	-	-	25	ns
T <sub>AS</sub>	Address Setup Time	Pins: RS,RW,E	0	-	-	ns
T <sub>AH</sub>	Address Hold Time	Pins: RS,RW,E	10	-	-	ns
T <sub>DDR</sub>	Data Setup Time	Pins: DB0 - DB7	-	-	100	ns
T <sub>H</sub>	Data Hold Time	Pins: DB0 - DB7	10	-	-	ns
<i>Interface Mode with LCD Driver(ST7065)</i>						
T <sub>CWH</sub>	Clock Pulse with High	Pins: CL1, CL2	800	-	-	ns
T <sub>CWL</sub>	Clock Pulse with Low	Pins: CL1, CL2	800	-	-	ns
T <sub>CST</sub>	Clock Setup Time	Pins: CL1, CL2	500	-	-	ns
T <sub>SU</sub>	Data Setup Time	Pin: D	300	-	-	ns
T <sub>DH</sub>	Data Hold Time	Pin: D	300	-	-	ns
T <sub>DM</sub>	M Delay Time	Pin: M	0	-	2000	ns

## 8 Instruction Description

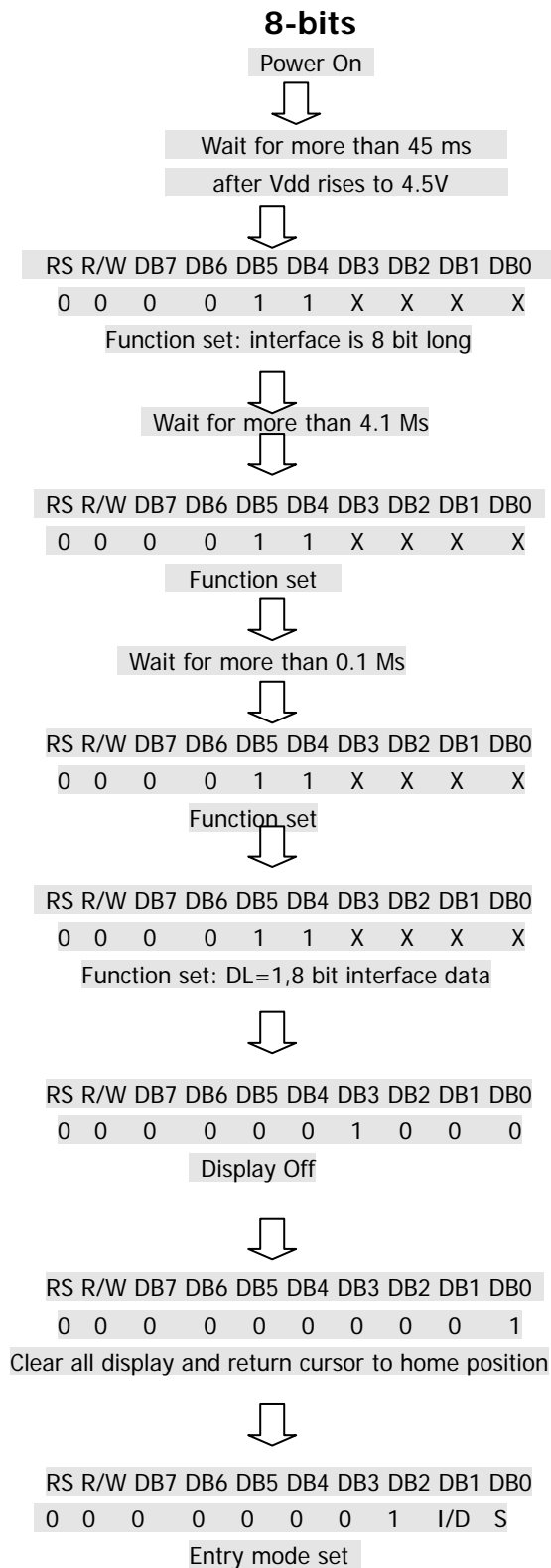

**END OF INITIALIZATION**

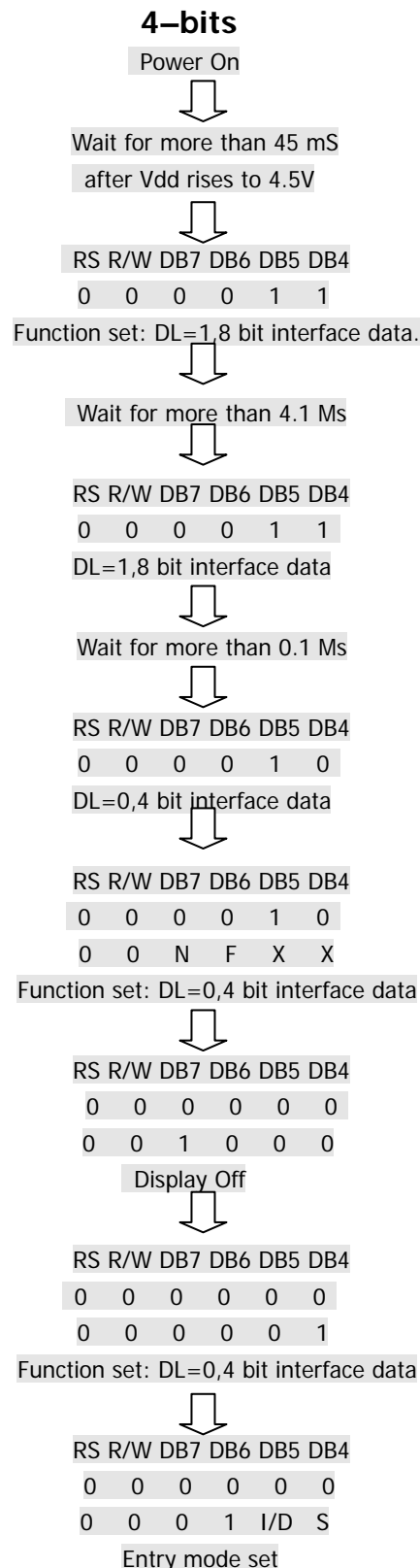

**END OF INITIALIZATION**

## 8.1 Software Examples

### 8-BIT OPERATION 8 characters X 2 lines

Function	RS RW D7 D6 D5 D4 D3 D2 D1 D0	DISPLAY	DESCRIPTION
Power on delay			Initialization. No display appears.
Function set	0 0 0 0 1 1 0 0 X X	----- -----	Sets 8-bit operation, 2-line display and 5*7 dots character font.
Display OFF	0 0 0 0 0 0 1 0 0 0		Turn off display.
Display ON	0 0 0 0 0 0 1 1 1 0		Turn on display and cursor.
Entry Mode set	0 0 0 0 0 0 0 1 1 0	----- -----	Set mode to increment the address by one and to shift the cursor to the right, at the time of write to the DD/CG RAM. Display is not shifted.
Write data to CG/DD RAM	1 0 0 1 0 0 0 1 1 0	F----- -----	Write "F". Cursor incremented by one and shift to right.
Write data to CG/DD RAM	1 0 0 1 0 1 0 1 0 1	FU----- -----	Write "U". Cursor incremented by one and shift to right
Write data to CG/DD RAM	. . . . .	FUTURE----- -----	Write "T" "U" "R" "E".
Set DDRAM address	0 0 1 1 0 0 0 0 0 0	FUTURE----- -----	Set RAM address so that the cursor is positioned at the head of the Second line
Write data to CG/DD RAM	. . . . .	FUTURE----- DS-----	Write "D" "S".
Cursor or display shift	0 0 0 0 0 1 0 0 X X	FUTURE----- DS-----	Shift only the cursor position to the left.
Write data to CG/DD RAM	. . . . .	FUTURE----- DISPLAY-----	Write "I" "S" "P" "L" "A" "Y"

### 4-bit operation (4-bits 1 line)

Function	RS RW D7 D6 D5 D4	Display	Description
power on delay			Initialization. No display appears.
Frnction set	0 0 0 0 1 0		Sets to 4-bit operation. In this case, operation is handled as 8-bits by initialization, and Only this instruction completes with one write.
Frnction set	0 0 0 0 1 0 0 0 0 0 X X		Sets 4-bit operation, 1-line display and 5*7 dot character font. (number of display lines and character fontscannot be changed hence after.)
Display ON/OFF Control	0 0 0 0 0 0 0 0 1 1 1 0		Turn on display and cursor.
Entry Mode Set	0 0 0 0 0 0 0 0 0 1 1 0		Turn on display and cursor.
Write data to CG/DD/ARM	1 0 0 1 0 0 1 0 1 1 1 1		Write "O". Curaor incrementer by one and shift to right.
<b>same as 8-bit operation</b>			

## 9 QUALITY SPECIFICATIONS

### 9.1 Defect classification

Classify	Item		Note	AQL
Major	Display state	Short or open circuit	1	0.4
		Contrast defect (dim, ghost)		
		LC leakage		
		Flickering		
		No display		
		Wrong viewing direction	2	
		Wrong Back-light	7	
	Non-display	Flat cable or pin reverse	9	
		Wrong or missing component	10	
	Minor	Display state	Background color deviation	
Black spot and dust			3	
Line defect			4	
Scratch				
Rainbow			5	
Pin hole			6	
Polarizer		Bubble and foreign material	3	
		Scratch	4	
PCB		Scratch	4	
Soldering		Poor connection	8	
Wire		Poor connection	9	

**9.2 Note on defect classification**

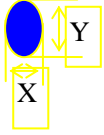
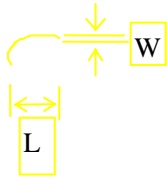
No.	Item	Criterion																				
1	Short or open circuit	Not allow																				
	LC leakage																					
	Flickering																					
	No display																					
	Wrong viewing direction																					
	Wrong Back-light																					
2	Contrast defect	Refer to approval sample																				
	Background color deviation																					
3	Point defect, Black spot, dust (incl. Polarizer)  $\phi = (X+Y)/2$	 <table border="1" style="margin-left: auto; margin-right: auto;"> <thead> <tr> <th>Point Size</th> <th>Acceptable Qty.</th> </tr> </thead> <tbody> <tr> <td><math>\phi \leq 0.10</math></td> <td>Disregard</td> </tr> <tr> <td rowspan="2"><math>0.10 &lt; \phi \leq 0.15</math></td> <td>Positive:4</td> </tr> <tr> <td>Negative:3</td> </tr> <tr> <td rowspan="2"><math>0.15 &lt; \phi \leq 0.2</math></td> <td>Positive:3</td> </tr> <tr> <td>Negative:2</td> </tr> <tr> <td><math>\phi &gt; 0.2</math></td> <td>0</td> </tr> </tbody> </table> <p style="text-align: right;">Unit: mm</p>	Point Size	Acceptable Qty.	$\phi \leq 0.10$	Disregard	$0.10 < \phi \leq 0.15$	Positive:4	Negative:3	$0.15 < \phi \leq 0.2$	Positive:3	Negative:2	$\phi > 0.2$	0								
Point Size	Acceptable Qty.																					
$\phi \leq 0.10$	Disregard																					
$0.10 < \phi \leq 0.15$	Positive:4																					
	Negative:3																					
$0.15 < \phi \leq 0.2$	Positive:3																					
	Negative:2																					
$\phi > 0.2$	0																					
4	Line defect	 <table border="1" style="margin-left: auto; margin-right: auto;"> <thead> <tr> <th colspan="2">Line</th> <th>Acceptable Qty.</th> </tr> <tr> <th>L</th> <th>W</th> <th></th> </tr> </thead> <tbody> <tr> <td>---</td> <td><math>0.015 \geq W</math></td> <td>Disregard</td> </tr> <tr> <td><math>3.0 \geq L</math></td> <td><math>0.03 \geq W</math></td> <td rowspan="2">2</td> </tr> <tr> <td><math>2.0 \geq L</math></td> <td><math>0.05 \geq W</math></td> </tr> <tr> <td><math>1.0 \geq L</math></td> <td><math>0.1 &gt; W</math></td> <td>1</td> </tr> <tr> <td>---</td> <td><math>0.05 &lt; W</math></td> <td>Applied as point defect</td> </tr> </tbody> </table> <p style="text-align: right;">Unit: mm</p>	Line		Acceptable Qty.	L	W		---	$0.015 \geq W$	Disregard	$3.0 \geq L$	$0.03 \geq W$	2	$2.0 \geq L$	$0.05 \geq W$	$1.0 \geq L$	$0.1 > W$	1	---	$0.05 < W$	Applied as point defect
Line		Acceptable Qty.																				
L	W																					
---	$0.015 \geq W$	Disregard																				
$3.0 \geq L$	$0.03 \geq W$	2																				
$2.0 \geq L$	$0.05 \geq W$																					
$1.0 \geq L$	$0.1 > W$	1																				
---	$0.05 < W$	Applied as point defect																				
5	Rainbow	Not more than two color changes across the viewing area.																				

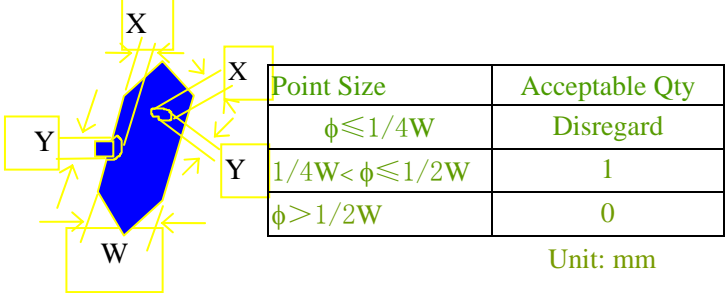
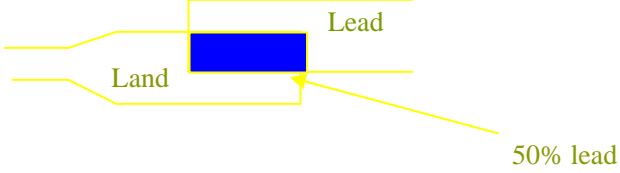
No.	Item	Criterion								
6	Segment pattern $W = \text{Segment width}$ $\phi = (X+Y)/2$	(1) Pin hole $\phi < 0.10\text{mm}$ is acceptable.  <table border="1" data-bbox="933 510 1396 683"> <thead> <tr> <th>Point Size</th> <th>Acceptable Qty</th> </tr> </thead> <tbody> <tr> <td><math>\phi \leq 1/4W</math></td> <td>Disregard</td> </tr> <tr> <td><math>1/4W &lt; \phi \leq 1/2W</math></td> <td>1</td> </tr> <tr> <td><math>\phi &gt; 1/2W</math></td> <td>0</td> </tr> </tbody> </table> <p style="text-align: right;">Unit: mm</p>	Point Size	Acceptable Qty	$\phi \leq 1/4W$	Disregard	$1/4W < \phi \leq 1/2W$	1	$\phi > 1/2W$	0
Point Size	Acceptable Qty									
$\phi \leq 1/4W$	Disregard									
$1/4W < \phi \leq 1/2W$	1									
$\phi > 1/2W$	0									
7	Back-light	(1) The color of backlight should correspond its specification. (2) Not allow flickering								
8	Soldering	(1) Not allow heavy dirty and solder ball on PCB. (The size of dirty refer to point and dust defect) (2) Over 50% of lead should be soldered on Land. 								
9	Wire	(1) Copper wire should not be rusted (2) Not allow crack on copper wire connection. (3) Not allow reversing the position of the flat cable. (4) Not allow exposed copper wire inside the flat cable.								
10	PCB	(1) Not allow screw rust or damage. (2) Not allow missing or wrong putting of component.								

11

LCD

2.1.1 chip on the surface

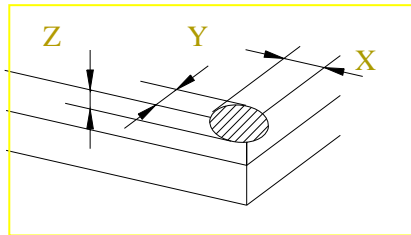
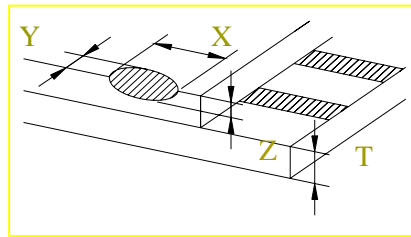
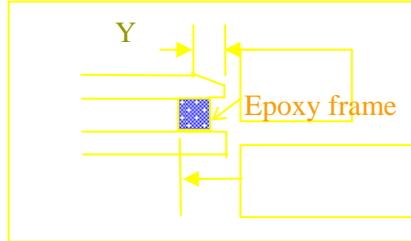
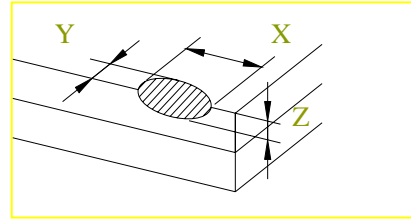

X	Y	Z
$>1/8A$	$\leq 0.3\text{mm}$	$\leq 1/2T$
$\leq 1/8A$	Not enter into epoxy frame	$\leq T$
	Not enter into the inner edge of epoxy	$\leq 1/2T$



11

LCD

2.1.2 chip on the terminal

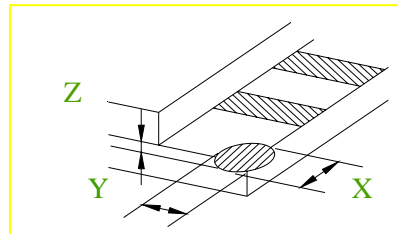
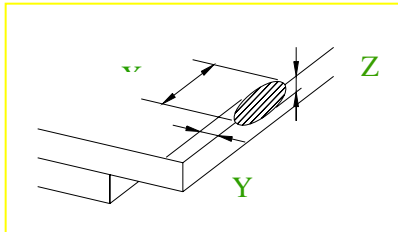
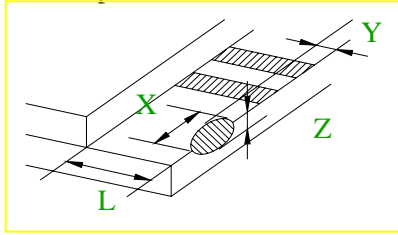

X	Y	Z
$>1/8A$	$\leq 0.3\text{mm}$	$\leq 1/2T$
$\leq 1/8A$	$\leq 1/2L$	$\leq T$
$\leq 1/8A$ 且 $\leq 1\text{mm}$	$\leq L$	$\leq T$
$\leq 1/8A$ 且 $\leq 2\text{mm}$	$\leq L$	$\leq 1/2T$

Note: the distance between crack and contact pad must be greater than the width of 1<sup>st</sup> contact pad

2.1.3 chip out on between side

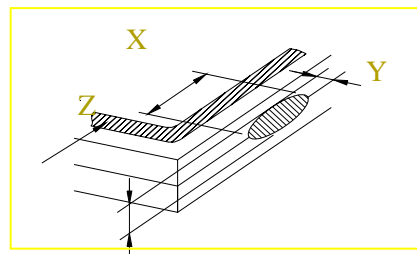

11

LCD

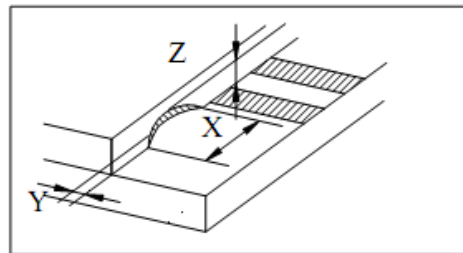
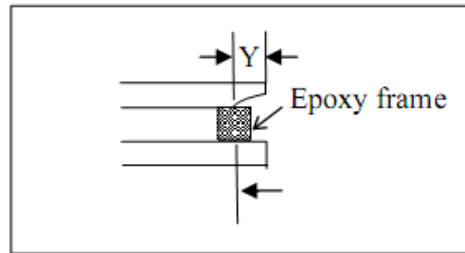

X	Y	Z
$\leq 1/8A$	Not enter into epoxy frame	$Z \leq 2T$
	Not enter into 1/2 epoxy frame	$Z \leq 1/2T$

2.1.4 including corner chip and side chip

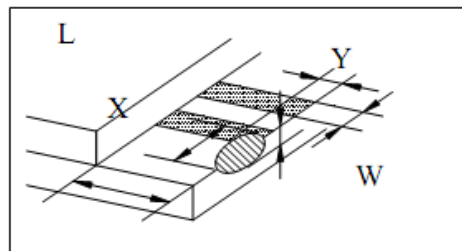

X	Y	Z
$> 1/8A$	$\leq 1/6L$	$\leq 1/2T$
$\leq 1/8A$	$\leq 1/3L$	
$\leq 1/4W$	$\leq 2/3L$	

11

LCD

### 2.2 Chip out

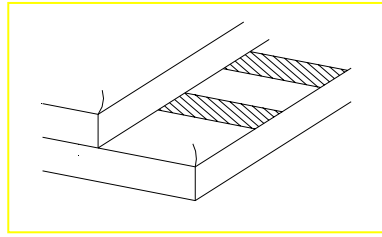

- 1) Chip out is that crackles extend to inner edge .
- 2) Crackles round epoxy frame will be rejected.
- 3) Chip out on the terminal will be rejected:  $Z=T$   
length  $>1\text{mm}$   
or  $Z<T$  length  $>2\text{mm}$
- 4) The chip out at ITO will be rejected.

### 2.3 Poor cutting

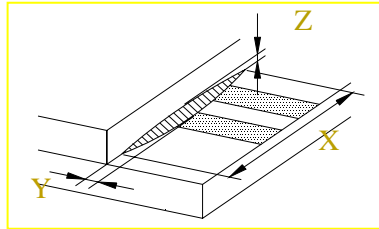

X	Y	Z
$>1/8A$	$\leq 0.3$	$\leq 1/2T$
$\leq 1/8A$	According to drawing	$1/2T \leq Z \leq T$

Any one out of the specification will be rejected.

### 9.3. Reliability of LCM

Reliability test condition:

Item	Condition	Time (hrs)	Assessment
High temp. Storage	+80°C	72	No abnormalities in functions and appearance
High temp. Operating	+70°C	72	
Low temp. Storage	-30°C	72	
Low temp. Operating	-20°C	72	
Humidity	40°C/ 90%RH	72	
Temp. Cycle	-20°C ← 25°C → +70°C (1 hour ← 5 min → 1 hour)	10cycles	

### 10.DESCRIBE TO THE PART NO:

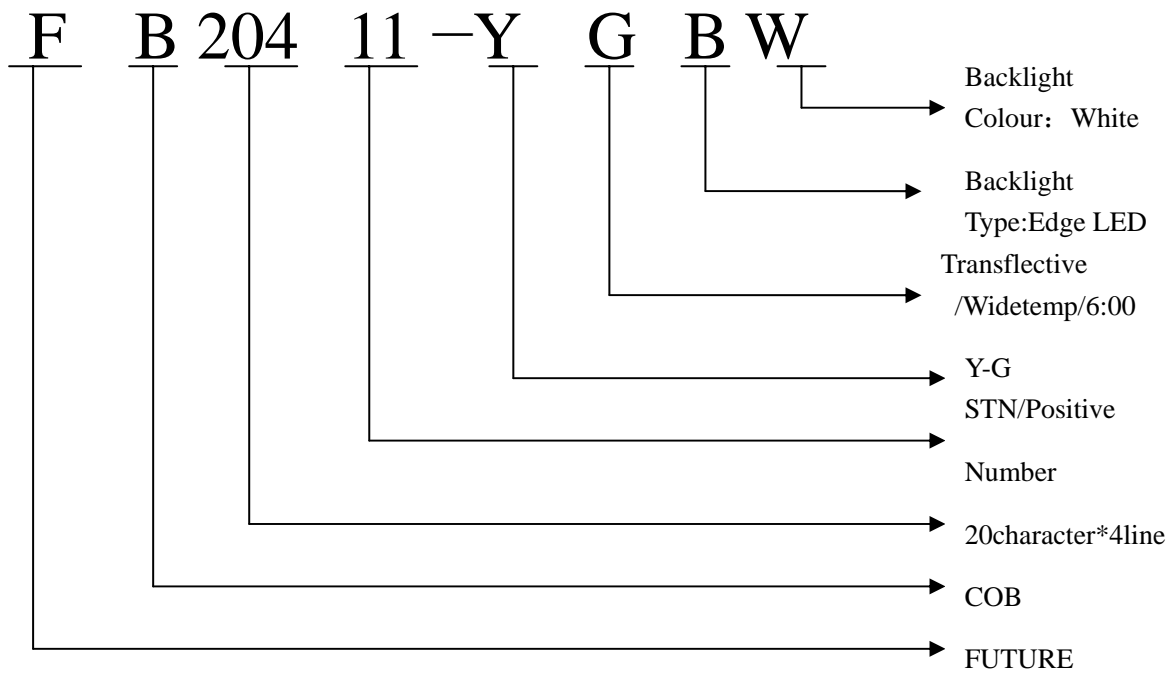

### 11.GUARRANTEE

Our products could meet requirements of the environment. Future's RoHS is introduced European Union Directive 2002/95/EC (RoHS) Requirements and Update.

## 12. Character Pattern

NO.7066-0A

b7-b4 b3-b0	0000	0001	0010	0011	0100	0101	0110	0111	1000	1001	1010	1011	1100	1101	1110	1111
0000	CG RAM (1)			0	9	P	\	P				-	9	3	0	P
0001	(2)		!	1	A	Q	a	9			.	7	7	4	3	q
0010	(3)		"	2	B	R	b	r			「	イ	ウ	×	P	0
0011	(4)		#	3	C	S	c	s			」	ウ	テ	E	S	∞
0100	(5)		\$	4	D	T	d	t			√	エ	ト	ト	μ	0
0101	(6)		%	5	E	U	e	u			*	オ	オ	ユ	0	0
0110	(7)		&	6	F	V	f	v			ヲ	カ	ニ	ヨ	P	Σ
0111	(8)		^	7	G	W	g	w			フ	十	又	ラ	g	π
1000	(1)		(	8	H	X	h	x			イ	ウ	オ	リ	フ	又
1001	(2)		)	9	I	Y	i	y			0	ウ	ル	リ	ユ	
1010	(3)		*	:	J	Z	j	z			エ	コ	ン	レ	j	〒
1011	(4)		+	:	K	[	k	(			*	ウ	E	0	×	π
1100	(5)		,	<	L	≠	l	l			ト	ウ	フ	フ	0	π
1101	(6)		-	=	M	I	m	)			ユ	又	レ	レ	レ	÷
1110	(7)		.	>	N	^	n	÷			ヨ	セ	ホ	レ	π	
1111	(8)		/	?	0	_	o	+			ウ	ウ	又	"	0	■