

# DISPLAYTRONIC

*XIAMEN ZETTLER ELECTRONICS CO., LTD.*

## SPECIFICATIONS FOR LIQUID CRYSTAL DISPLAY

| CUSTOMER APPROVAL   |  |                 |  |
|---|--|-----------------|--|
|   |  |                 |  |
| ※ PART NO. : <u>ACM1601H-FLW-GTW-M01(DISPLAYSTRONIC) VER1.0</u> |  |                 |  |
| APPROVAL  |  | COMPANY<br>CHOP |  |
| CUSTOMER<br>COMMENTS  |  |                 |  |

| DISPLAYTRONIC ENGINEERING APPROVAL |            |             |
|------------------------------------|------------|-------------|
| DESIGNED BY                        | CHECKED BY | APPROVED BY |
| JiangFM                            | LIU        | GuZH        |

**REVISION RECORD**

| REVISION | REVISION DATE | PAGE | CONTENTS    |
|----------|---------------|------|-------------|
| VER1.0   | 07/08/2012    |      | FIRST ISSUE |

※ **CONTENTS**

- 1.0 GENERAL SPECS
- 2.0 ABSOLUTE MAXIMUM RATINGS
- 3.0 ELECTRICAL CHARACTERISTICS
- 4.0 OPTICAL CHARACTERISTICS
- 5.0 BLOCK DIAGRAM
- 6.0 PIN ASSIGNMENT
- 7.0 POWER SUPPLY
- 8.0 TIMING CHARACTERISTICS
- 9.0 MECHANICAL DIAGRAM
- 10.0 RELIABILITY TEST
- 11.0 DISPLAY INSTRUCTION TABLE
- 12.0 STANDARD CHARACTER PATTERNS
- 13.0 PRECAUTION FOR USING LCM

## 1.0 GENERAL SPECS

|                             |  |
|-----------------------------|--|
| 1. Display Format           | 16*1 Character   |
| 2. Power Supply             | 3.3V(Single power supply with integrated DC-DC,adjustable Vop) |
| 3. Module Outline Dimension | 122.0mm(W) x 33.0mm(H) x max 13.5mm(D)                         |
| 4. Viewing Area(W*H)        | 99.0mm(W) x 13.0mm(H)  |
| 5. Dot Size (W*H)           | 0.92mm(W) x 1.10mm(H)  |
| 6. Dot Pitch (W*H)          | 0.98mm(W) x 1.16mm(H)  |
| 7. Character Size (W*H)     | 4.84mm(W) x 9.22mm(H)  |
| 8. Character Pitch (W*H)    | 5.94mm(W) x ---  |
| 9. Viewing Direction        | 12:00 O'Clock  |
| 10. Driving Method          | 1/16Duty,1/5Bias   |
| 11. Control IC              | ST7066U-0A or compatible                                       |
| 12. Display Mode            | Gray STN/Positive / Transflective                              |
| 13. Backlight               | LED-side/White   |
| 14. Operating Temperature   | -20°C ~ 70°C   |
| 15. Storage Temperature     | -30°C ~ 80°C   |
| 16. RoHS                    | RoHS compliant   |

## 2.0 ABSOLUTE MAXIMUM RATINGS

| Item                           | Symbol   | Min     | Typ | Max     | Unit |
|--------------------------------|----------|---------|-----|---------|------|
| Operating temperature          | Top      | -20     | --  | 70      | °C   |
| Storage temperature            | Tst      | -30     | --  | 80      | °C   |
| Input voltage                  | Vin      | Vss-0.3 | --  | Vdd+0.3 | V    |
| Supply voltage for logic       | Vdd- Vss | 2.7     | --  | 5.5     | V    |
| Supply voltage for LCD driving | Vdd- V0  | 3.0     | --  | 8.0     | V    |

## 3.0 ELECTRICAL CHARACTERISTICS

### 3.1 Electrical Characteristics Of LCM

| Item                        | Symbol        | Condition                           | Min    | Typ | Max  | Unit |
|-----------------------------|---------------|-------------------------------------|--------|-----|------|------|
| Power Supply Voltage        | Vdd           | 25°C                                | 3.1    | 3.3 | 3.5  | V    |
| Power Supply Current        | Idd           | Vdd=3.3V, fosc=270kHz               | --     | 3.5 | 5.0  | mA   |
| Input voltage (high)        | Vih           | Pins:(E,RS,R/W,DB0-DB7)<br>VDD=3.3V | 0.7Vdd | --  | Vdd  | V    |
| Input voltage (low)         | Vil           |                                     | 0      | --  | 0.55 | V    |
| Recommended Driving Voltage | LC<br>Vdd -V0 | -20°C                               | 4.6    | 4.8 | 5.0  | V    |
|                             |               | 25°C                                | 4.3    | 4.5 | 4.7  |      |
|                             |               | 70°C                                | 4.0    | 4.2 | 4.4  |      |

### 3.2 The Characteristics Of LED Backlight

#### 3.2.1 Electrical-Optical Characteristics Of LED Backlight (Ta=25°C)

| Item                                | Symbol | Condition      | Min  | Typ   | Max  | Unit              |
|-------------------------------------|--------|----------------|------|-------|------|-------------------|
| Forward Voltage <sup>(1)</sup>      | Vf     | If=30mA        | 2.9  | 3.1   | 3.3  | V                 |
| Reverse Voltage                     | Vr     | -              | --   | --    | 5    | V                 |
| Luminance <sup>(2)</sup>            | Lv     | If=30mA        | 260  | 360   | --   | cd/m <sup>2</sup> |
| Uniformity <sup>(3)</sup>           | Δ      | (Lvmin/Lvmax)% | 70%  | --    | --   | -                 |
| Peak wave length                    | λ p    | -              | --   | --    | --   | nm                |
| Chroma coordinate <sup>(5)(6)</sup> | x      | If=30mA        | 0.26 | --    | 0.30 | um                |
|                                     | y      | If=30mA        | 0.27 | --    | 0.31 | um                |
| Lifetime <sup>(4)</sup>             | -      | If=30mA        | -    | 20000 | -    | Hours             |

NOTE:

(1) Forward voltage means voltage applied directly to the LED, please refer to the backlight diagram.

(2)The luminance is the average value of 5 points, The measurement instrument is BM-7 luminance colorimeter. The diameter of aperture is Φ5mm

(3) Luminance means the backlight brightness without LCD.

(4) Backlight lifetime means luminance value larger than half of the original after 20000 hours' continuous working.

(5) Please apply the backlight current as the table recommend. If LCM surface luminance is acceptable, please apply the driving current as lower as possible. Any time, do not apply the driving current higher than 40mA.

#### 3.2.2 Backlight Control Circuit for LCM (2x1=2 pcs LED)

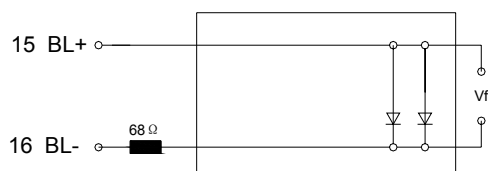

#### 3.2.3 LED Typical Electro-Optical Characteristics Curve (for single led)

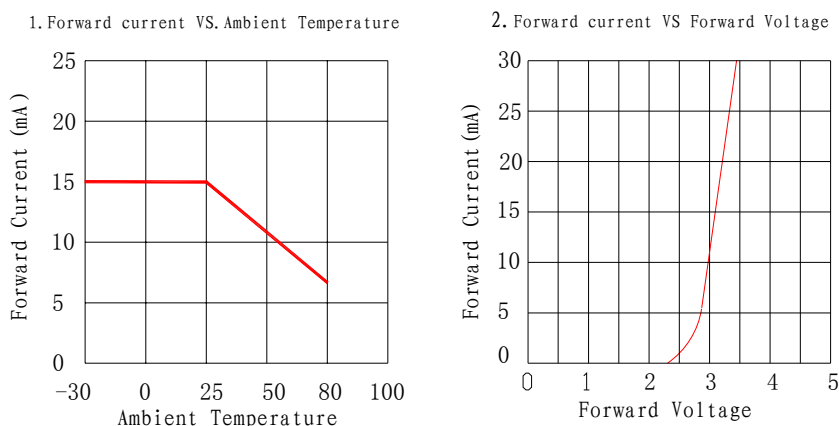

### 4.0 OPTICAL CHARACTERISTICS (Ta=25°C)

| Item                         | Symbol     | Condition                            | Min | Typ | Max | Unit |
|------------------------------|------------|--------------------------------------|-----|-----|-----|------|
| Viewing angle (Left - right) | $\theta_2$ | $Cr \geq 2.0$                        | -35 | -   | 35  | deg  |
| Viewing angle (Up-down)      | $\theta_1$ | $Cr \geq 2.0$                        | -40 | -   | 25  | deg  |
| Contrast Ratio               | Cr         | $\theta_1=0^\circ, \theta_2=0^\circ$ | -   | 6.0 | -   |      |
| Response time (rise)         | Tr         | $\theta_1=0^\circ, \theta_2=0^\circ$ | -   | 180 | 300 | ms   |
| Response time (fall)         | Tf         | $\theta_1=0^\circ, \theta_2=0^\circ$ | -   | 150 | 250 | ms   |

#### (1). Definition of Optical Response Time

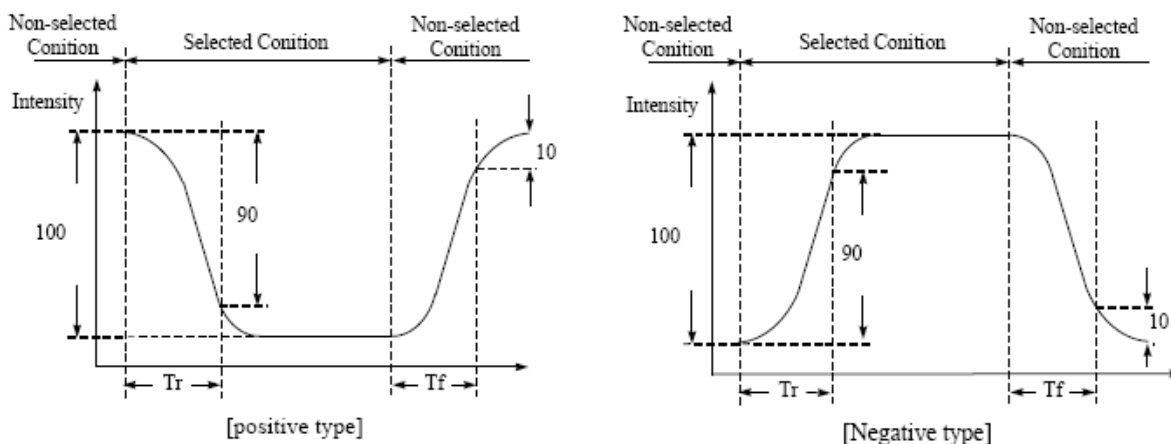

#### (2). Definition of Contrast Ratio

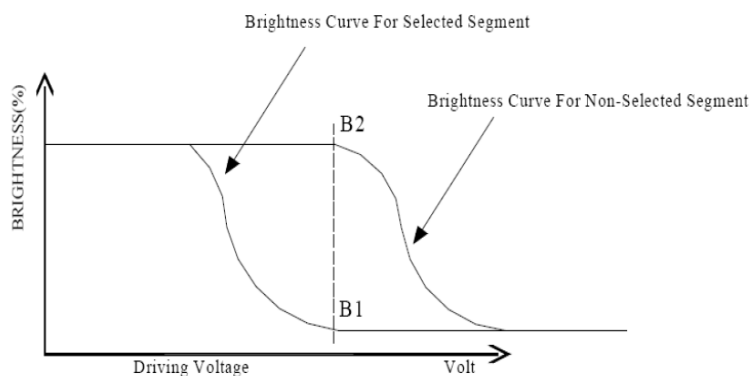

$$Cr = \frac{\text{Brightness of Non-selected Segment(B2)}}{\text{Brightness of selected Segment(B1)}}$$

#### (3). Definition of Viewing Angle $\theta_2$ and $\theta_1$

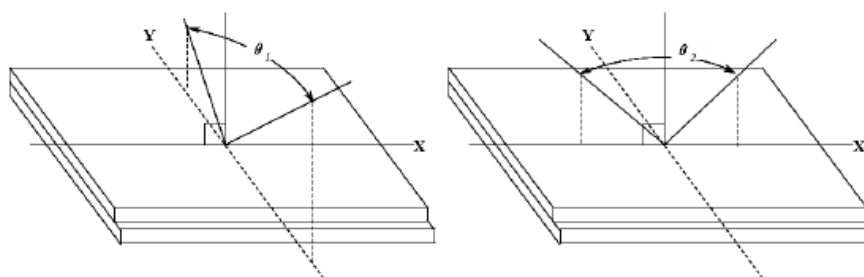

5.0 BLOCK DIAGRAM

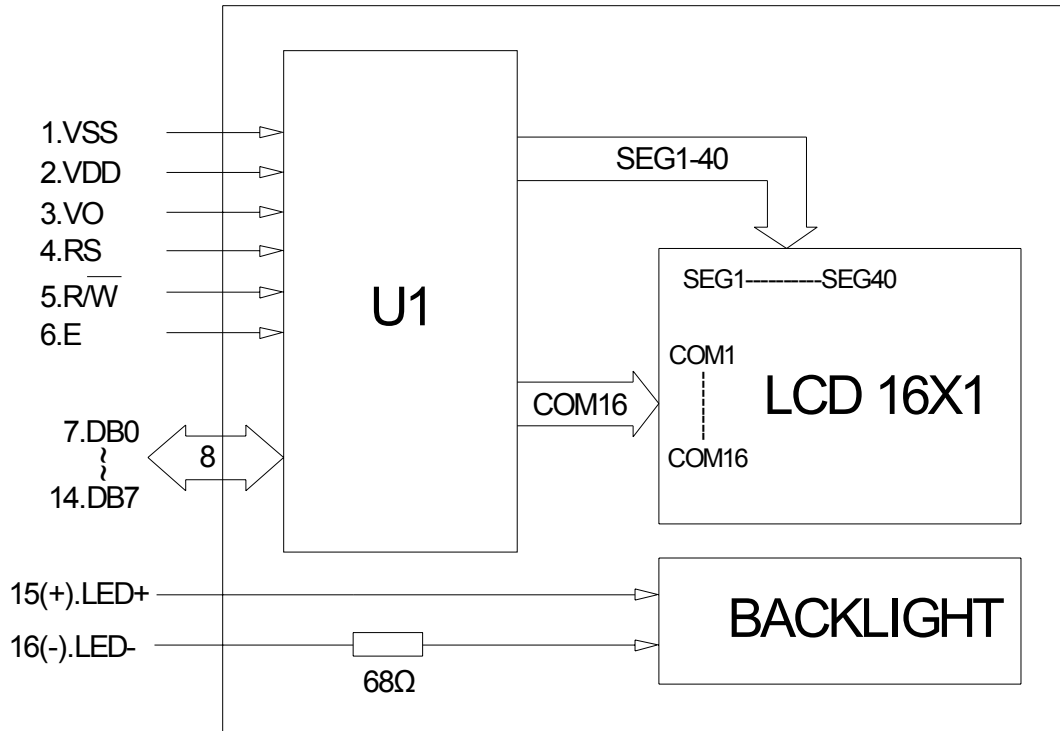

## 6.0 PIN ASSIGNMENT

| Pin No. | Symbol          | Function             |
|---------|-----------------|----------------------|
| 1       | V <sub>ss</sub> | Ground               |
| 2       | V <sub>dd</sub> | +3.3V                |
| 3       | V <sub>o</sub>  | LCD contrast adjust  |
| 4       | RS              | Register select      |
| 5       | R/W             | Read / Write Signal  |
| 6       | E               | Enable Signal        |
| 7       | DB0             | Data bit 0           |
| 8       | DB1             | Data bit 1           |
| 9       | DB2             | Data bit 2           |
| 10      | DB3             | Data bit 3           |
| 11      | DB4             | Data bit 4           |
| 12      | DB5             | Data bit 5           |
| 13      | DB6             | Data bit 6           |
| 14      | DB7             | Data bit 7           |
| 15      | BL+             | Power Supply for BL+ |
| 16      | BL-             | Power Supply for BL- |

## 7.0 POWER SUPPLY

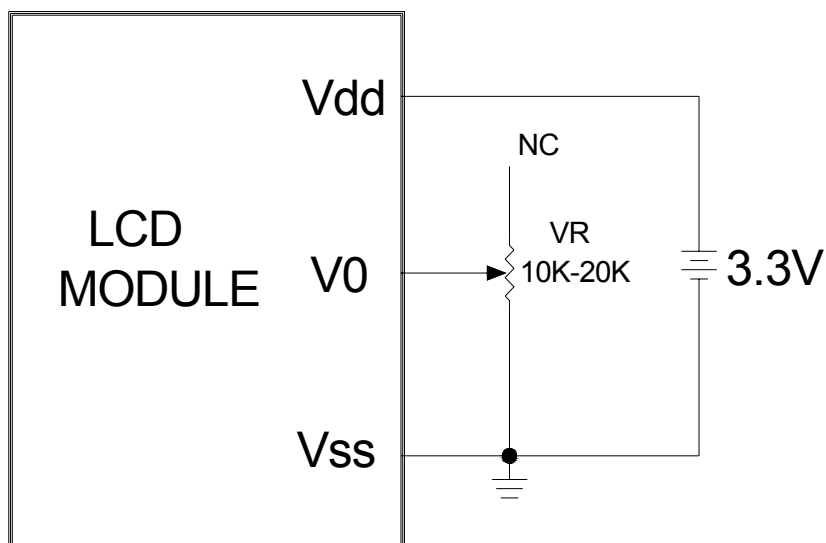



## 8.0 TIMING CHARACTERISTICS

### Write mode (Writing Data from MPU to ST7066U)

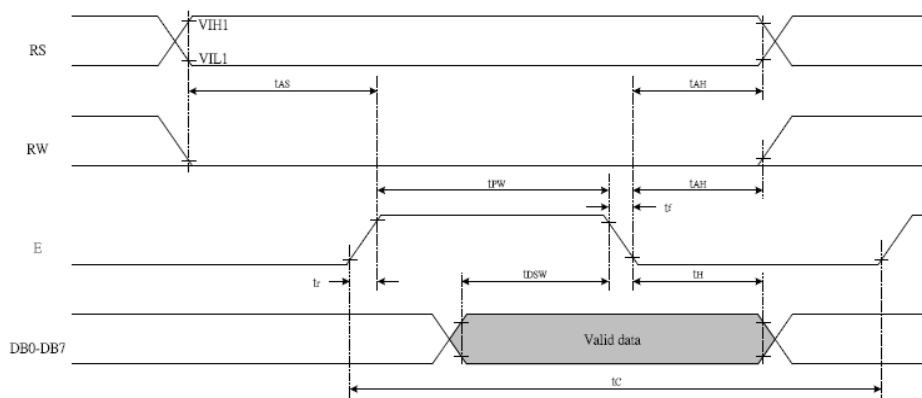

### Read mode (Reading Data from ST7066U to MPU)

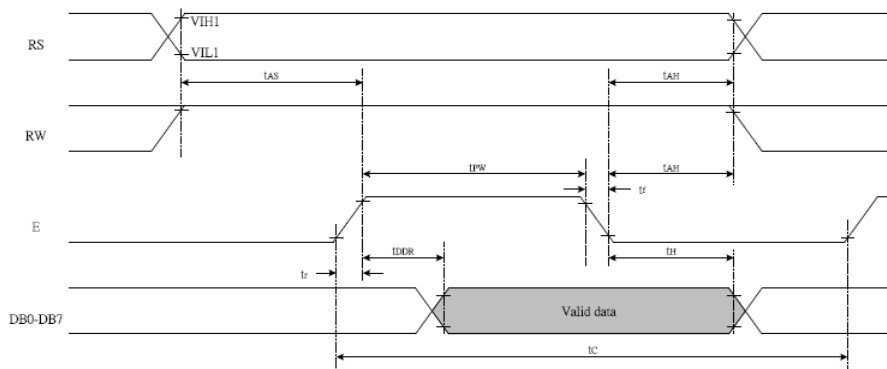

| Write Mode (Writing data from MPU to ST7066U) |                       |                 |      |   |     |    |
|---|-----------------------|-----------------|------|---|-----|----|
| $T_C$   | Enable Cycle Time     | Pin E           | 1200 | - | -   | ns |
| $T_{PW}$                                      | Enable Pulse Width    | Pin E           | 460  | - | -   | ns |
| $T_{R,T_F}$                                   | Enable Rise/Fall Time | Pin E           | -    | - | 25  | ns |
| $T_{AS}$                                      | Address Setup Time    | Pins: RS,RW,E   | 0    | - | -   | ns |
| $T_{AH}$                                      | Address Hold Time     | Pins: RS,RW,E   | 10   | - | -   | ns |
| $T_{DSW}$                                     | Data Setup Time       | Pins: DB0 - DB7 | 80   | - | -   | ns |
| $T_H$   | Data Hold Time        | Pins: DB0 - DB7 | 10   | - | -   | ns |
| Read Mode (Reading Data from ST7066U to MPU)  |                       |                 |      |   |     |    |
| $T_C$   | Enable Cycle Time     | Pin E           | 1200 | - | -   | ns |
| $T_{PW}$                                      | Enable Pulse Width    | Pin E           | 480  | - | -   | ns |
| $T_{R,T_F}$                                   | Enable Rise/Fall Time | Pin E           | -    | - | 25  | ns |
| $T_{AS}$                                      | Address Setup Time    | Pins: RS,RW,E   | 0    | - | -   | ns |
| $T_{AH}$                                      | Address Hold Time     | Pins: RS,RW,E   | 10   | - | -   | ns |
| $T_{DDR}$                                     | Data Setup Time       | Pins: DB0 - DB7 | -    | - | 320 | ns |
| $T_H$   | Data Hold Time        | Pins: DB0 - DB7 | 10   | - | -   | ns |

For more details, please refer to IC specification.

9.0 MECHANICAL DIAGRAM

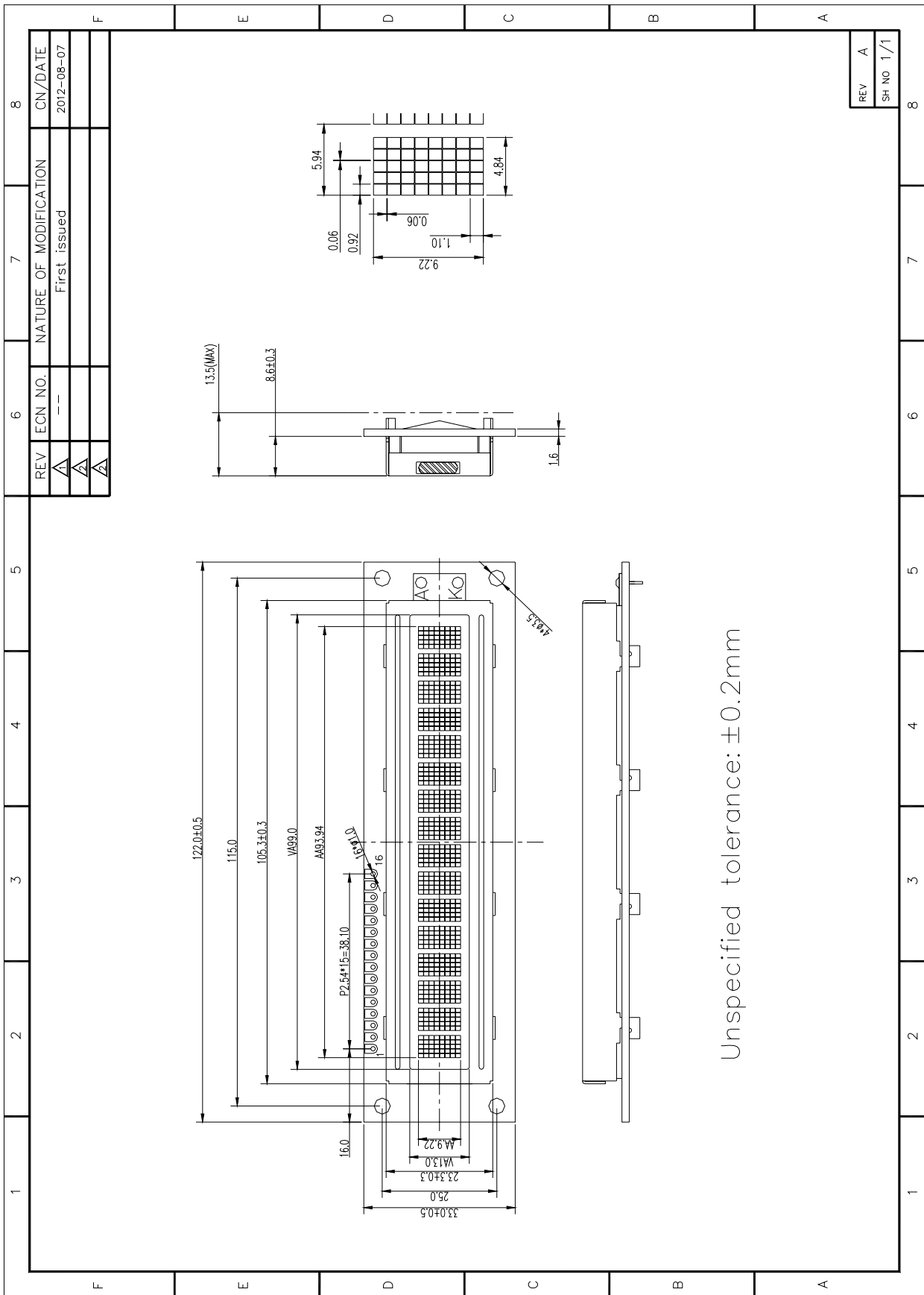

## 10.0 RELIABILITY TEST

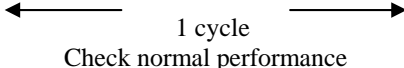
| NO | Test Item          | Description                            | Test Condition  | Remark   |                |
|----|--------------------|--|---|--|----------------|
| 1  | Environmental Test | High temperature storage               | Applying the high storage temperature<br>Under normal humidity for a long time<br>Check normal performance  | 80 °C<br>96hrs   |                |
| 2  |                    | Low temperature storage                | Applying the low storage temperature<br>Under normal humidity for a long time<br>Check normal performance   | -30°C<br>96hrs   |                |
| 3  |                    | High temperature Operation             | Apply the electric stress(Voltage and current) Under high temperature for a long time   | 70 °C<br>96hrs   | Note1          |
| 4  |                    | Low temperature Operation              | Apply the electric stress Under low temperature for a long time   | -20°C<br>96hrs   | Note1<br>Note2 |
| 5  |                    | High temperature/High Humidity Storage | Apply high temperature and high humidity storage for a long time  | 90% RH<br>40°C<br>96hrs  | Note2          |
| 6  |                    | Temperature Cycle                      | Apply the low and high temperature cycle<br>-30°C <> 25°C <> 80°C <> 25°C<br>30min 10min 30min 10min<br><br>1 cycle<br>Check normal performance | -30°C/80°C<br>10 cycle   |                |
| 7  | Mechanical Test    | Vibration test(Package state)          | Applying vibration to product check normal performance  | Freq:10~55~10Hz<br>Amplitude:0.75mm<br>1cycle time:1min<br>X.Y.Z every direction for 15 cycles |                |
| 8  |                    | Shock test(package state)              | Applying shock to product check normal performance  | Drop them through 70cm height to strike horizontal plane                                       |                |
| 9  | Other              |  |   |  |                |

**Remark**

Note1:Normal operations condition (25°C±5°C).

Note2:Pay attention to keep dewdrops from the module during this test.

## 11.0 DISPLAY INSTRUCTION TABLE

| Instruction                        | Instruction Code |    |     |     |     |     |     |     |     |     | Description   | Execution time<br>(Temp = 25°C) |                 |                 |
|------------------------------------|------------------|----|-----|-----|-----|-----|-----|-----|-----|-----|---|---------------------------------|-----------------|-----------------|
|                                    | RS               | RW | DB7 | DB6 | DB5 | DB4 | DB3 | DB2 | DB1 | DB0 |   | Fosc=<br>190KHz                 | Fosc=<br>270KHz | Fosc=<br>350KHz |
| Clear Display                      | 0                | 0  | 0   | 0   | 0   | 0   | 0   | 0   | 0   | 1   | Write "20H" to DDRAM and set DDRAM address to "00H" from AC   | 2.16ms                          | 1.52ms          | 1.18ms          |
| Return Home                        | 0                | 0  | 0   | 0   | 0   | 0   | 0   | 0   | 1   | -   | Set DDRAM address to "00H" from AC and return cursor to its original position if shifted. The contents of DDRAM are not changed.      | 2.16ms                          | 1.52ms          | 1.18ms          |
| Entry Mode Set                     | 0                | 0  | 0   | 0   | 0   | 0   | 0   | 1   | I/D | S   | Assign cursor moving direction and enable the shift of entire display   | 53μs                            | 38μs            | 29μs            |
| Display ON/OFF Control             | 0                | 0  | 0   | 0   | 0   | 0   | 1   | D   | C   | B   | Set display (D), cursor(C), and blinking of cursor(B) on/off control bit.   | 53μs                            | 38μs            | 29μs            |
| Cursor or Display Shift            | 0                | 0  | 0   | 0   | 0   | 1   | S/C | R/L | -   | -   | Set cursor moving and display shift control bit, and the direction, without changing of DDRAM data.                                   | 53μs                            | 38μs            | 29μs            |
| Function Set                       | 0                | 0  | 0   | 0   | 1   | DL  | N   | F   | -   | -   | Set interface data length (DL: 8-bit/4-bit), numbers of display line (N: 2-line/1-line) and, display font type (F:5x10 dots/5x8 dots) | 53μs                            | 38μs            | 29μs            |
| Set CGRAM Address                  | 0                | 0  | 0   | 1   | AC5 | AC4 | AC3 | AC2 | AC1 | AC0 | Set CGRAM address in address counter.   | 53μs                            | 38μs            | 29μs            |
| Set DDRAM Address                  | 0                | 0  | 1   | AC6 | AC5 | AC4 | AC3 | AC2 | AC1 | AC0 | Set DDRAM address in address counter  | 53μs                            | 38μs            | 29μs            |
| Read Busy Flag and Address Counter | 0                | 1  | BF  | AC6 | AC5 | AC4 | AC3 | AC2 | AC1 | AC0 | Whether during internal operation or not can be known by reading BF. The contents of address counter can also be read.                |                                 |                 |                 |
| Write Data to RAM                  | 1                | 0  | D7  | D6  | D5  | D4  | D3  | D2  | D1  | D0  | Write data into internal RAM (DDRAM/CGRAM).   | 53μs                            | 38μs            | 29μs            |
| Read Data from RAM                 | 1                | 1  | D7  | D6  | D5  | D4  | D3  | D2  | D1  | D0  | Read data from internal RAM (DDRAM/CGRAM).  | 53μs                            | 38μs            | 29μs            |

## 12.0 STANDARD CHARACTER PATTERNS

| Lower 4 Bits \ Upper 4 Bits | 0000       | 0001 | 0010 | 0011 | 0100 | 0101 | 0110 | 0111 | 1000 | 1001 | 1010 | 1011 | 1100 | 1101 | 1110 | 1111 |
|-----------------------------|------------|------|------|------|------|------|------|------|------|------|------|------|------|------|------|------|
| xxxx0000                    | CG RAM (1) |      |      | 0    | a    | P    | `    | P    |      |      |      | -    | 9    | 3    | α    | ρ    |
| xxxx0001                    | (2)        |      | !    | 1    | A    | Q    | a    | 9    |      |      | α    | 7    | 4    | ä    | 9    |      |
| xxxx0010                    | (3)        |      | "    | 2    | B    | R    | b    | r    |      |      | Γ    | ι    | ψ    | χ    | ρ    | θ    |
| xxxx0011                    | (4)        |      | #    | 3    | C    | S    | c    | s    |      |      | ∟    | ∩    | ∫    | ε    | ∞    |      |
| xxxx0100                    | (5)        |      | \$   | 4    | D    | T    | d    | t    |      |      | √    | I    | †    | μ    | Ω    |      |
| xxxx0101                    | (6)        |      | %    | 5    | E    | U    | e    | u    |      |      | •    | ♠    | ♣    | ♠    | ü    |      |
| xxxx0110                    | (7)        |      | &    | 6    | F    | V    | f    | v    |      |      | ヲ    | カ    | ニ    | ヨ    | ρ    | Σ    |
| xxxx0111                    | (8)        |      | '    | 7    | G    | W    | g    | w    |      |      | ア    | キ    | ヌ    | ウ    | g    | π    |
| xxxx1000                    | (1)        |      | (    | 8    | H    | X    | h    | x    |      |      | イ    | ウ    | ホ    | リ    | ∫    | ⊗    |
| xxxx1001                    | (2)        |      | )    | 9    | I    | Y    | i    | y    |      |      | ウ    | ク    | ル    | ル    | '    | ∫    |
| xxxx1010                    | (3)        |      | *    | :    | J    | Z    | j    | z    |      |      | エ    | コ    | ∩    | ∨    | j    | ≠    |
| xxxx1011                    | (4)        |      | +    | ;    | K    | [    | k    | [    |      |      | オ    | サ    | ヒ    | ロ    | °    | ≠    |
| xxxx1100                    | (5)        |      | ,    | <    | L    | ¥    | l    | l    |      |      | ホ    | シ    | フ    | ワ    | ⊕    | ≠    |
| xxxx1101                    | (6)        |      | -    | =    | M    | ]    | m    | )    |      |      | ユ    | ズ    | ∧    | ∩    | ≠    | ÷    |
| xxxx1110                    | (7)        |      | .    | >    | N    | ^    | n    | ÷    |      |      | ヨ    | セ    | ホ    | °    | ≠    |      |
| xxxx1111                    | (8)        |      | /    | ?    | O    | _    | o    | +    |      |      | ウ    | リ    | マ    | ロ    | ö    | ■    |

Note: The character generator RAM is the RAM with which the user can rewrite character patterns by program.

### 13.0 PRECAUTION FOR USING LCM

1. When design the product with this LCD Module, make sure the viewing angle matches to its purpose of usage.
2. As LCD panel is made of glass substrate, Dropping the LCD module or banging it against hard objects may cause cracking or fragmentation. Especially at corners and edges.
3. Although the polarizer of this LCD Module has the anti-glare coating, always be careful not to scratch its surface. Use of a plastic cover is recommended to protect the surface of polarizer.
4. If the LCD module is stored at below specified temperature, the LC material may freeze and be deteriorated. If it is stored at above specified temperature, the molecular orientation of the LC material may change to Liquid state and it may not revert to its original state. Excessive temperature and humidity could cause polarizer peel off or bubble. Therefore, the LCD module should always be stored within specified temperature range.
5. Saliva or water droplets must be wiped off immediately as those may leave stains or cause color changes if remained for a long time. Water vapor will cause corrosion of ITO electrodes.
6. If the surface of LCD panel needs to be cleaned, wipe it swiftly with cotton or other soft cloth. If it is not still clean enough, blow a breath on the surface and wipe again.
7. The module should be driven according to the specified ratings to avoid malfunction and permanent damage. Applying DC voltage cause a rapid deterioration of LC material. Make sure to apply alternating waveform by continuous application of the M signal. Especially the power ON/OFF sequence should be kept to avoid latch-up of driver LSIs and DC charge up to LCD panel.
8. Mechanical Considerations
  - a) LCM are assembled and adjusted with a high degree of precision. Avoid excessive shocks and do not make any alterations or modifications. The following should be noted.
  - b) Do not tamper in any way with the tabs on the metal frame.
  - c) Do not modify the PCB by drilling extra holes, changing its outline, moving its components or modifying its pattern.
  - d) Do not touch the elastomer connector; especially insert a backlight panel (for example, EL).
  - e) When mounting a LCM makes sure that the PCB is not under any stress such as bending or twisting. Elastomer contacts are very delicate and missing pixels could result from slight dislocation of any of the elements.
  - f) Avoid pressing on the metal bezel, otherwise the elastomer connector could be deformed and lose contact, resulting in missing pixels.
9. Static Electricity
  - a) Operator

**Ware the electrostatics shielded clothes because human body may be statically charged if not ware shielded clothes. Never touch any of the conductive parts such as the LSI pads; the copper leads on the PCB and the interface terminals with any parts of the human body.**

b) Equipment

There is a possibility that the static electricity is charged to the equipment, which has a function of peeling or friction action (ex: conveyer, soldering iron, working table). Earth the equipment through proper resistance (electrostatic earth:  $1 \times 10^8$  ohm).

Only properly grounded soldering irons should be used.

If an electric screwdriver is used, it should be well grounded and shielded from commutator sparks.

The normal static prevention measures should be observed for work clothes and working benches; for the latter conductive (rubber) mat is recommended.

c) Floor

**Floor is the important part to drain static electricity, which is generated by operators or equipment.**

There is a possibility that charged static electricity is not properly drained in case of insulating floor. Set the electrostatic earth (electrostatic earth:  $1 \times 10^8$  ohm).

d) Humidity

Proper humidity helps in reducing the chance of generating electrostatic charges. Humidity should be kept over 50%RH.

e) Transportation/storage

**The storage materials also need to be anti-static treated because there is a possibility that the human body or storage materials such as containers may be statically charged by friction or peeling.**

The modules should be kept in antistatic bags or other containers resistant to static for storage.

f) Soldering

Solder only to the I/O terminals. Use only soldering irons with proper grounding and no leakage.

Soldering temperature :  $280^{\circ} \text{C} \pm 10^{\circ} \text{C}$

Soldering time: 3 to 4 sec.

Use eutectic solder with resin flux fill.

If flux is used, the LCD surface should be covered to avoid flux spatters. Flux residue should be removed afterwards.

g) Others

**The laminator (protective film) is attached on the surface of LCD panel to prevent it from scratches or stains. It should be peeled off slowly using static eliminator.**

Static eliminator should also be installed to the workbench to prevent LCD module from static charge.

10. Operation

- a) Driving voltage should be kept within specified range; excess voltage shortens display life.
  - b) Response time increases with decrease in temperature.
  - c) Display may turn black or dark blue at temperatures above its operational range; this is (however not pressing on the viewing area) may cause the segments to appear "fractured".
  - d) Mechanical disturbance during operation (such as pressing on the viewing area) may cause the segments to appear "fractured".
11. If any fluid leaks out of a damaged glass cell, wash off any human part that comes into contact with soap and water. The toxicity is extremely low but caution should be exercised at all the time.
  12. Disassembling the LCD module can cause permanent damage and it should be strictly avoided.
  13. LCD retains the display pattern when it is applied for long time (Image retention). To prevent image retention, do not apply the fixed pattern for a long time. Image retention is not a deterioration of LCD. It will be removed after display pattern is changed.
  14. Do not use any materials, which emit gas from epoxy resin (hardener for amine) and silicone adhesive agent (dealcohol or deoxym) to prevent discoloration of polarizer due to gas.
  15. Avoid the exposure of the module to the direct sunlight or strong ultraviolet light for a long time.