

iOPS-76 Series User Manual



2012 Jul V1

Copyright © 2012 IBASE Technology INC. All Rights Reserved.

No part of this manual, including the products and software described in it, may be reproduced, transmitted, transcribed, stored in a retrieval system, or translated into any language in any form or by any means, except documentation kept by the purchaser for backup purposes, without the express written permission of IBASE Technology INC. ("IBASE").

Products and corporate names mentioned in this manual may or may not be registered trademarks or copyrights of their respective companies, and are used for identification purposes only. All trademarks are the property of their respective owners.

Every effort has been made to ensure that the contents of this manual are correct and up to date. However, the manufacturer makes no guarantee regarding the accuracy of its contents, and reserves the right to make changes without prior notice.

Table of Contents

<i>Safety Information</i>	4
Setting up your system	4
Care during use	4
Acknowledgments.....	5
Table : Terms and Abbreviation	6
<i>Accessories</i>	7
<i>Components</i>	7
I/O View	7
<i>System Specification</i>	8
<i>Mechanical Specification</i>	9
<i>Assembly iOPS-76 series to the OPS display</i>	9
Intel® Open Pluggable Specification	10
JAE connector features	10
iOPS-76 + iOPS-EK1	11
iOPS-76 + iOPS-EK2	11
<i>Exploded view of the iOPS-76 assembly</i>	12
Parts description	12
<i>Installation</i>	12
Installing the memory	12
<i>Signal Description</i>	13
Signal definitions	14
<i>Drivers Installation</i>	17

Safety Information

Your IOPS-76 is designed and tested to meet the latest standards of safety for information technology equipment. However, to ensure your safety, it is important that you read the following safety instructions.

Setting up your system

- Read and follow all instructions in the documentation before you operate your system.
- Do not use this product near water.
- Set up the system on a stable surface. Do not secure the system on any unstable plane.
- Do not place this product on an unstable cart, stand, or table. The product may fall, causing serious damage to the product.
- Slots and openings on the chassis are for ventilation. Do not block or cover these openings. Make sure you leave plenty of space around the system for ventilation. ***Never insert objects of any kind into the ventilation openings.***
- This system should be operated from the type of power indicated on the marking label. If you are not sure of the type of power available, consult your dealer or local power company.
- Use this product in environments with ambient temperatures between 0°C and 45°C.
- If you use an extension cord, make sure that the total ampere rating of the devices plugged into the extension cord does not exceed its ampere rating.
- DO NOT LEAVE THIS EQUIPMENT IN AN ENVIRONMENT WHERE THE STORAGE TEMPERATURE MAY GO BELOW -20° C (-4° F) OR ABOVE 80° C (176° F). THIS COULD DAMAGE THE EQUIPMENT. THE EQUIPMENT SHOULD BE IN A CONTROLLED ENVIRONMENT.

Care during use

- Do not walk on the power cord or allow anything to rest on it.
- Do not spill water or any other liquids on your system.
- When the system is turned off, a small amount of electrical current still flows.

Always unplug all power, and network cables from the power outlets before cleaning the system.

- If you encounter the following technical problems with the product, unplug the power cord and contact a qualified service technician or your retailer.
 - The power cord or plug is damaged.
 - Liquid has been spilled into the system.
 - The system does not function properly even if you follow the operating instructions.
 - The system was dropped or the cabinet is damaged.

Lithium-Ion Battery Warning

CAUTION: Danger of explosion if battery is incorrectly replaced. Replace only with the same or equivalent type recommended by the manufacturer. Dispose of used batteries according to the manufacturer's instructions.

NO DISASSEMBLY

The warranty does not apply to the products that have been disassembled by users

WARNING
HAZARDOUS MOVING PARTS
KEEP FINGERS AND OTHER BODY PARTS AWAY



Acknowledgments

- AMI is a registered trademark of AMI Software International, Inc.
- Intel are registered trademarks of Intel Corporation.
- Microsoft Windows is a registered trademark of Microsoft Corporation.
- FINTEK is a registered trademark of FINTEK Electronics Corporation.
- REALTEK is a registered trademark of REALTEK Electronics Corporation.
- All other product names or trademarks are properties of their respective owners.

Table : Terms and Abbreviation

Term	Description
CPU	Central Processing Unit
DP	Display Port
DS	Digital Signage
DVI	Digital Video Interface
HDMI	High Definition Multimedia Interface
LCD	Liquid Crystal Display
OPS	Open Pluggable Specification
PCH	Platform Controller Hub
UART	Universal Asynchronous Receiver/Transmitter
USB	Universal Serial Bus
Wifi	Wireless IEEE 802.11 technology
SSD	Solid State Drive
SATA	Serial ATA
EPIC	Embedded Platform for Industrial Computing form factor 165 mm x 115 mm
AC/DC	Alternating Current/Direct Current
AMT	Intel® Active Management Technology
CEC	Consumer Electronics Control, for Proof of Play/Display and panel detection
DDR	Double Data Rate – referring to random access memory(RAM)
DIMM	Dual In-line Memory Module
GbE	Gigabit Ethernet
GPIO	General Purpose Input Output
LAN	Local Area Network
LV	Low Voltage
PCIe	PCI Express
PoP	Proof of Play
RFID	Radio Frequency Identification technology
RJ45	Ethernet cable connector
TMDS	Transition Minimized Differential Signaling

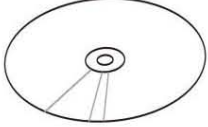
Accessories

	
a. Driver CD x 1	b. System Manual x 1

Components

I/O View

Refer to the diagram below to identify the components on this side of the system.



Power Bottom

The power switch allows powering ON and OFF the system.

Power

The power bottom LED illuminated when system been power on.

Display Port

The Display Port interface is to transmitting uncompressed digital data.

LAN 1

The eight-pin RJ-45 LAN port supports a standard Ethernet cable for connection

to a local network.

USB1/2

The USB (Universal Serial Bus 3.0) port is compatible with USB devices such as keyboards, mouse devices, cameras, and hard disk drives. USB allows many devices to run simultaneously on a single computer, with some peripheral acting as additional plug-in sites or hubs.

AUDIO

The stereo audio jack (3.5mm) is used to connect the system's audio out signal to amplified speakers or headphones.

System Specification

System Mainboard	IOPS-76 MB
Chassis Color	Black
Storage	64GB mSATA
Mounting	Open Pluggable Specification.
Power Supply	NA.
Operating Temperature	0°C ~ 45°C (32°F ~ 113°F)
Storage Temperature	-20°C ~ 80°C (-4°F~176°F)
Relative Humidity	5~90% @45°C (non-condensing)
Vibration	mSATA: 5 grms / 5~500Hz / random operation
Shock	mSATA: 15 Grms peak acceleration (11 msec duration)
RoHS	Available

·This specification is subject to change without prior notice.

Mechanical Specification

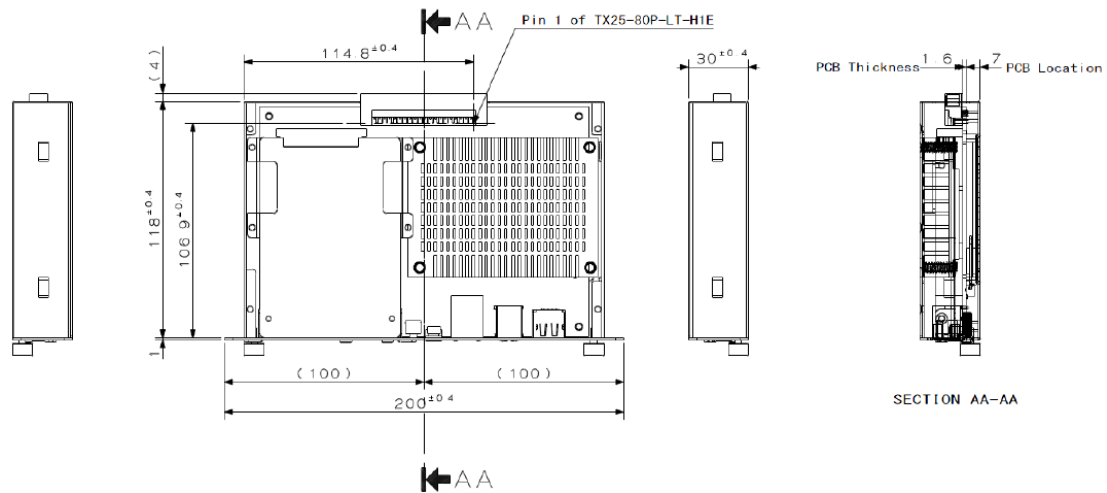

Assembly iOPS-76 series to the OPS display



You can assembly iOPS-76 series into all OPS (Open Pluggable Specification) display. It is follow Intel Open Pluggable Specification.

Intel® Open Pluggable Specification

The Intel® Open Pluggable Specification (OPS) is an effort to standardize the connector and signals between a slot PC and a digital signage display. This allows for an open slot PC standard which can be adopted by display and PC manufacturers, thereby enabling digital signage solutions that are more cost-effective to deploy, maintain, and upgrade.

JAE connector features

The connector used for the Pluggable Module and docking board Interconnect is based on the JAE TX24/TX25 family of plug and receptacle connectors. The JAE connector pins are capable to support up to a max current of 1A, for more detailed info please refer to the JAE connector datasheet or contact JAE representative. The 80-pin right angle blindmate plug connector (p/n: TX25-80P-LT-H1E) and its receptacle (p/n: TX24-80R-LT-H1E) provide interfacing for the following features:

Power: DC IN +12V~+19V

Display Interface: DVI-D/TMDS and DisplayPort

Audio: Left and Right Channel

*USB: 2*USB 2.0 and 1*USB 3.0*

UART: Serial communication (Tx and Rx only)

Control Signals: Pluggable Module Power Status, Power ON via display panel, Pluggable Board Detect, Consumer Electronics Control (CEC), and System Fan Control..

I/O Expansion Platform

- **iOPS-EK1** –The iOPS-76 can easily connects with iOPS-EK1 expansion dock through the JAE 80-pin connector, providing more I/O interface, and allows it to serve as a stand-alone operating system..
- **iOPS-EK2** - The iOPS-EK2 features additional 4x DisplayPort interface, making the iOPS-76 to become a multiple display solution (with 4,000 x 2,000 resolution support).

iOPS-76 + iOPS-EK1



iOPS-76 + iOPS-EK2



Exploded view of the iOPS-76 assembly

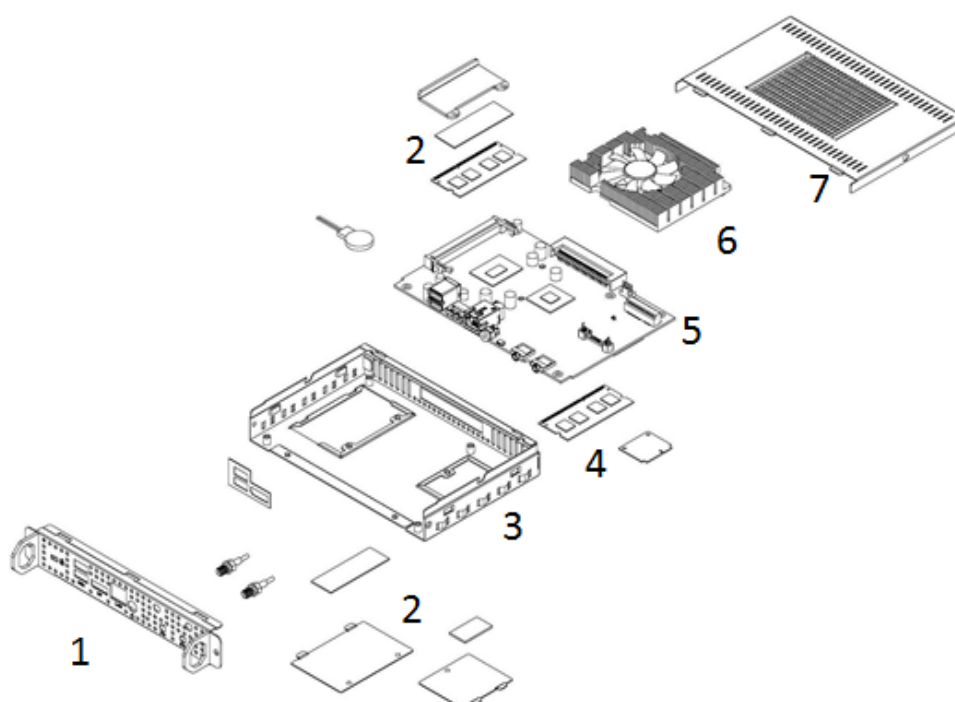

Parts description

Part NO.	Description	Part NO.	Description
1	Front panel	2	Bottom cover
3	Main chassis	4	Memory modules
5	iOPS-76 MB	6	Heatsink module
7	Top cover		

Installation

Installing the memory

The IB938 board supports two DDR3 memory socket for a maximum total memory of 16GB in DDR3 SO-DIMM memory type. Installing and Removing Memory Modules
To install the DDR3 modules, locate the memory slot on the board and perform the

following steps:

1. Hold the DDR3 module so that the key of the DDR3 module aligns with that on the memory slot. Insert the module into the socket at a slight angle (approximately 30 degrees). Note that the socket and module are both keyed, which means that the module can be installed only in one direction.
2. To seat the memory module into the socket, apply firm and even pressure to each end of the module until you feel it slip down into the socket.
3. With the module properly seated in the socket, rotate the module downward. Continue pressing downward until the clips at each end lock into position.
4. To remove the DDR3 module, press the clips with both hands.

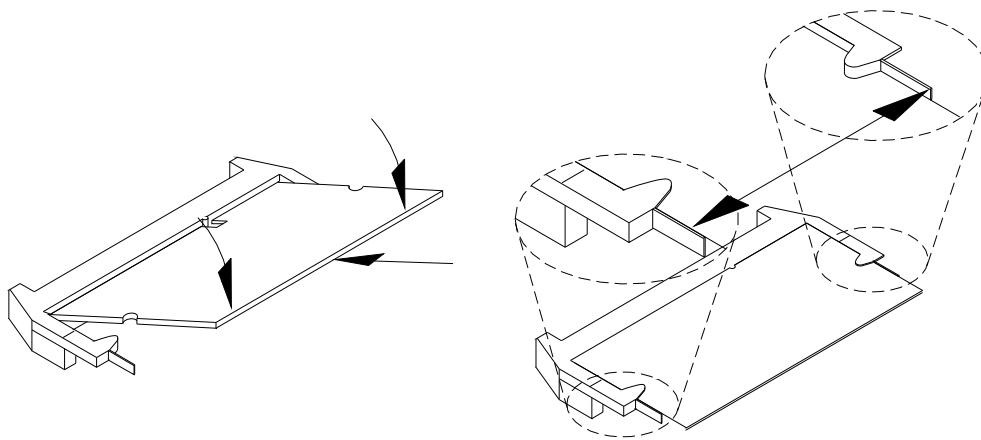

Signal Description

This section provides a detailed description of each signal passing thru the JAE connector. The signals are arranged in functional groups according to their associated interface.

The “#” symbol at the end of the signal name indicates that the active or asserted state occurs when the signal is at a low voltage level. When “#” is not present, the signal is asserted when at the high voltage level.

The following notations are used to describe the signal type with regards to the pluggable board:

I Input Pin

O Output Pin

OC Open Collector Output Pin.

The “Type” for each signal is indicative of the functional operating mode of the signal.

Signal definitions

Power & Ground Signals

Pin No.	Name	Type	Description
33, 34, 35, 36, 37, 38, 39, 40	+12V~+19V	-	The Pluggable Module supports a voltage range of +12V~+19V DC IN (mandatory). The <i>recommended</i> total current rating should be targeted at no more than 4A (500mA for each pin) to preserve connector pin reliability and also the limit on panel power supply compliance. <i>It is mandatory for the Pluggable Module(OPS) manufacturer to provide a Power Rating label on the Pluggable Module which includes the min. power required from the PANEL power supply to power up the pluggable platform sufficiently</i>
3, 6, 9, 12, 16, 19, 22, 25, 28, 32, 53, 56, 59, 62, 65, 68, 75, 76, 77, 78, 79, 80	GND	-	Ground

DVI-D Signals

Pin No.	Name	Type	Description
31	DVI_HPD	I	DVI Hot Plug Detect
30	DVI_DDC_CLK	I/O	Display Data Channel Signals DVI Control Data and Clock. These are single ended control signals used for communications between the chipset DVI display port and a panel device (Sink).
29	DVI_DDC_DATA		
27	TMDS2+	O	TMDS Data Channel
26	TMDS2-		
24	TMDS1+		
23	TMDS1-		
21	TMDS0+		
20	TMDS0-		
18	TMDS_CLK+	O	TMDS Clock Channel
17	TMDS_CLK-		

Display Port Signals

Pin No.	Name	Type	Description
15	DDP_HPD	I	Display Port Hot Plug Detect
14	DDP_AUXP	I/O	Display Port Auxiliary Channel
13	DDP_AUXN		
11	DDP_0P	O	Display Port Data Channel
10	DDP_0N		
8	DDP_1P		
7	DDP_1N		
5	DDP_2P		
4	DDP_2N		
2	DDP_3P		
1	DDP_3N		

Audio Signals

Pin No.	Name	Type	Description
70	AZ_LINEOUT_R	O	Audio Right Channel
69	AZ_LINEOUT_L	O	Audio Left Channel

USB Signals

Pin No.	Name	Type	Description
67	USB_PP0	I/O	USB2.0 Differential Pair
66	USB_PN0		
64	USB_PP1		
63	USB_PN1		
61	USB_PP2		
60	USB_PN2		
58	StdA_SSTX+	O	USB3.0 SuperSpeed Transmitter Differential Pair
57	StdA_SSTX-		
55	StdA_SSRX+	I	USB3.0 SuperSpeed Receiver Differential Pair
54	StdA_SSRX-		

UART Signals

Pin No.	Name	Type	Description
52	UART_TXD	O	Transmitted UART data from pluggable board, UART 3.3V LVTTTL signal
51	UART_RXD	I	Received UART data for pluggable board, UART 3.3V LVTTTL signal

Control Signals

Pin No.	Name	Type	Description
74	PWR_STATUS	OC	<p>Power status indication signal or Power Good status of the pluggable board. This pin shall be Open Collector and pull up to +3.3V on the docking/control board side.</p> <p>High: Pluggable board power off state Low: Pluggable board power on state</p> <p>Please refer to Figure 4 for illustration example.</p>
73	PS_ON#	I	<p>Pluggable Signal ON: This is meant for signal initiation to power ON or boot up the Pluggable Module. PS_ON# shall be asserted at least 500ms after power is delivered from PSU to the board via the JAE connector (G3 to S5 state). Pull up to +3.3V on the pluggable board.</p> <p>Use case: Power Button initiation from the panel control board to the Pluggable board via for e.g., IR remote control ON. The PWRBTN# pin on the Intel ICH/PCH can be utilized for this purpose. PWRBTN# has a 16 ms of internal debounce logic. External debouncing circuit is not required. Please refer more to the respective platform design guide and chipset datasheet.</p> <p>+If the pluggable board present state is S5 ,the transitions start as soon as the PWRBTN# is pressed (but after the debounce logic), and does not depend on when the Power Button is released.</p> <p>+If pluggable board present state is S0-S4 and if PWRBTN# held low for at least four consecutive seconds, this will initiate unconditional transition to S5 state.</p> <p>**This timing spec applies only for Intel ICHx series and 5 series chipset. For other platforms, please refer to the respective component Power Button spec.</p> <p>Please refer to Figure 5 for illustration example</p>

Pin No.	Name	Type	Description
72	PB_DET	O	Pluggable board detection. Output signal, recommend grounded on the pluggable board side with pull up to +3.3V on the docking/control board side High: No Pluggable Low: Pluggable board Present Please refer to Figure 6 for illustration example
71	CEC	I/O	Consumer Electronics Control for Proof of Play/Display initiative. Can also be used for display panel status detection and other control functions. The display panel control CPU shall support this functionality.
50	SYS_FAN	O	System Fan: This signal shall be used to control the display panel system fan. Recommended pull up +3.3V on docking board side and routed to the system fan control. High: System Fan OFF Low: System Fan ON *1 Note *1: This signal shall be triggered ON by the thermal management system (EC) in the pluggable module only when needed. Use case: In situation where display panel is in standby mode and the Pluggable Module is still operating (e.g., remote maintenance etc), system fan solution may still be needed and since display panel is in standby mode there is no way to control the system fan. This pin therefore serves as an option to trigger the system fan to operate when necessary.

Reserved Pins

Pin No.	Name	Type	Description
41, 42, 43, 44, 45, 46, 47, 48, 49	RSVD	-	These pins are RESERVED for future expansion and shall be left as No Connect(NC)

Drivers Installation

This section describes the installation procedures for software and drivers. The software and drivers are included with the motherboard. If you find the items missing, please contact the vendor where you made the purchase. The contents of this section include the following:

IMPORTANT NOTE:

After installing your Windows operating system, you must install first the Intel Chipset Software Installation Utility before proceeding with the drivers installation.

Intel Chipset Software Installation Utility

The Intel Chipset Drivers should be installed first before the software drivers to enable Plug & Play INF support for Intel chipset components. Follow the instructions below to complete the installation.

1. Insert the CD that comes with the board. Click Intel and then Intel(R) 7 Series Chipset Drivers..



2. Click Intel(R) Chipset Software Installation Utility.



2. When the Welcome screen to the Intel® Chipset Device Software appears, click **Next** to continue.



3. Click **Yes** to accept the software license agreement and proceed with the installation process.



4. Click **Next** to continue the installation process.



5. On the Readme File Information screen, click Next to continue the installation.

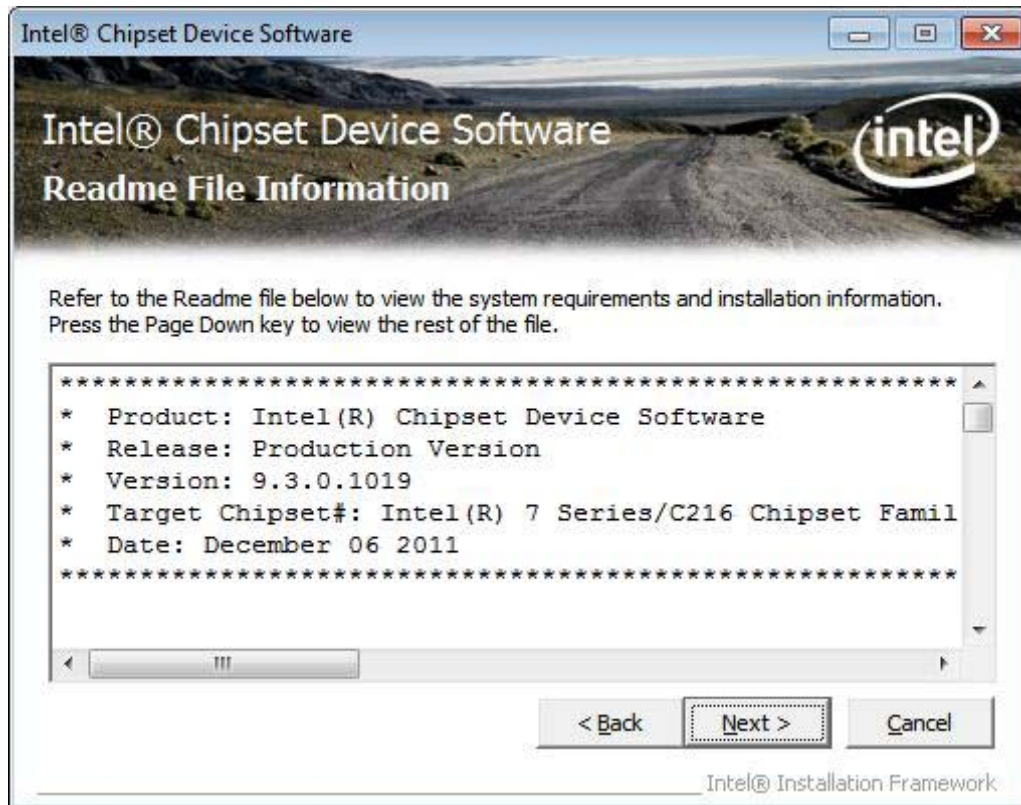

6. The Setup process is now complete. Click Finish to restart the computer and for changes to take effect.



VGA Drivers Installation

NOTE: Before installing the Intel(R) Q77 Chipset Family Graphics Driver, the Microsoft .NET Framework 3.5 SPI should be first installed.

To install the VGA drivers, follow the steps below.

1. Insert the CD that comes with the board. Click Intel and then Intel(R) Q7 Series Chipset Drivers.



2. Click Intel(R) Q77 Chipset Family Graphics Driver. DRIVERS INSTALLATION 54



3. When the Welcome screen appears, click Next to continue.

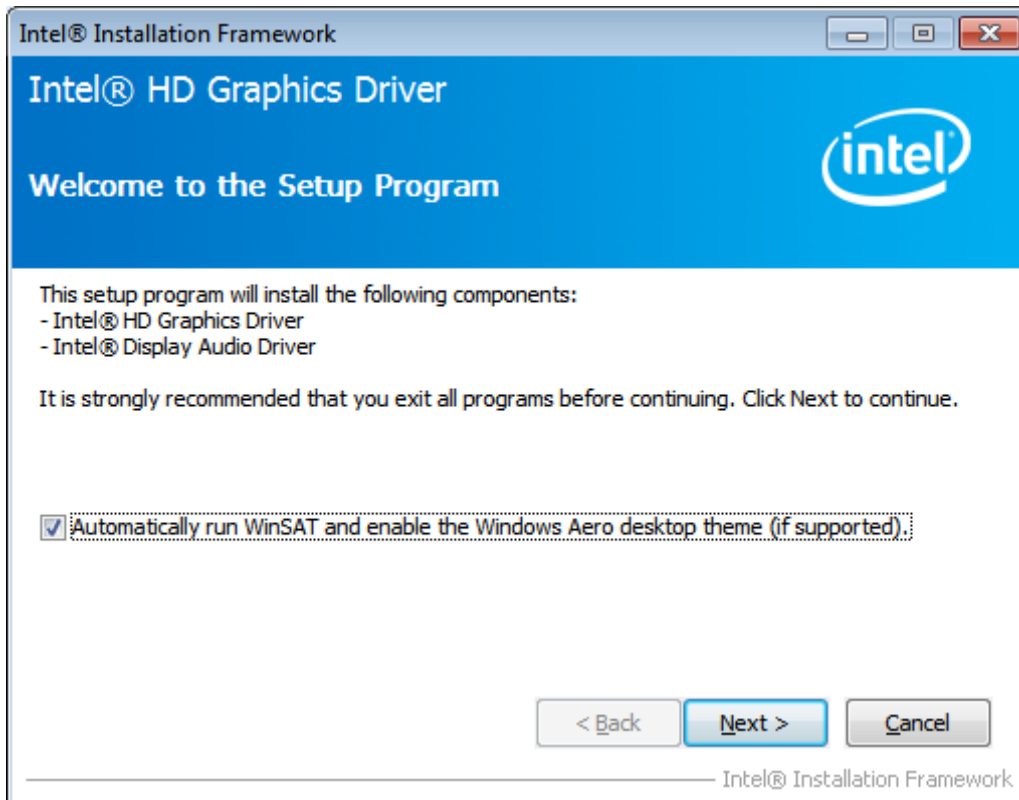

- Click Yes to to agree with the license agreement and continue the installation.

DRIVERS INSTALLATION

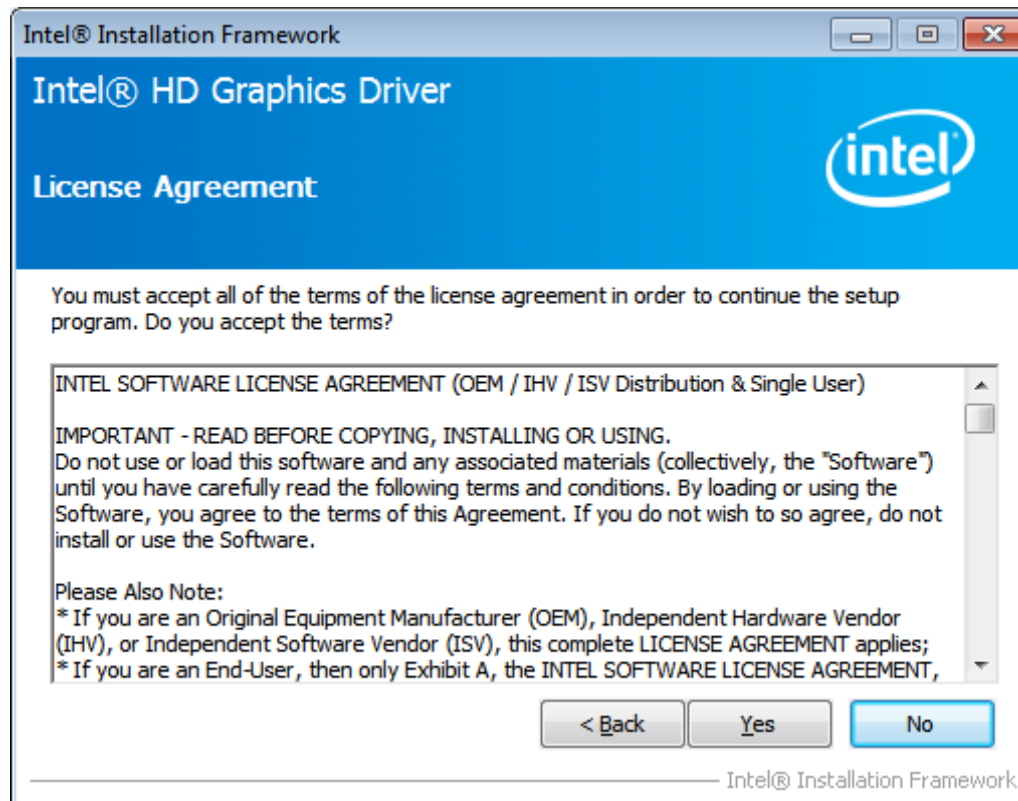

- On the Readme File Information screen, click Next to continue the installation of the Intel® Graphics Media Accelerator Driver.

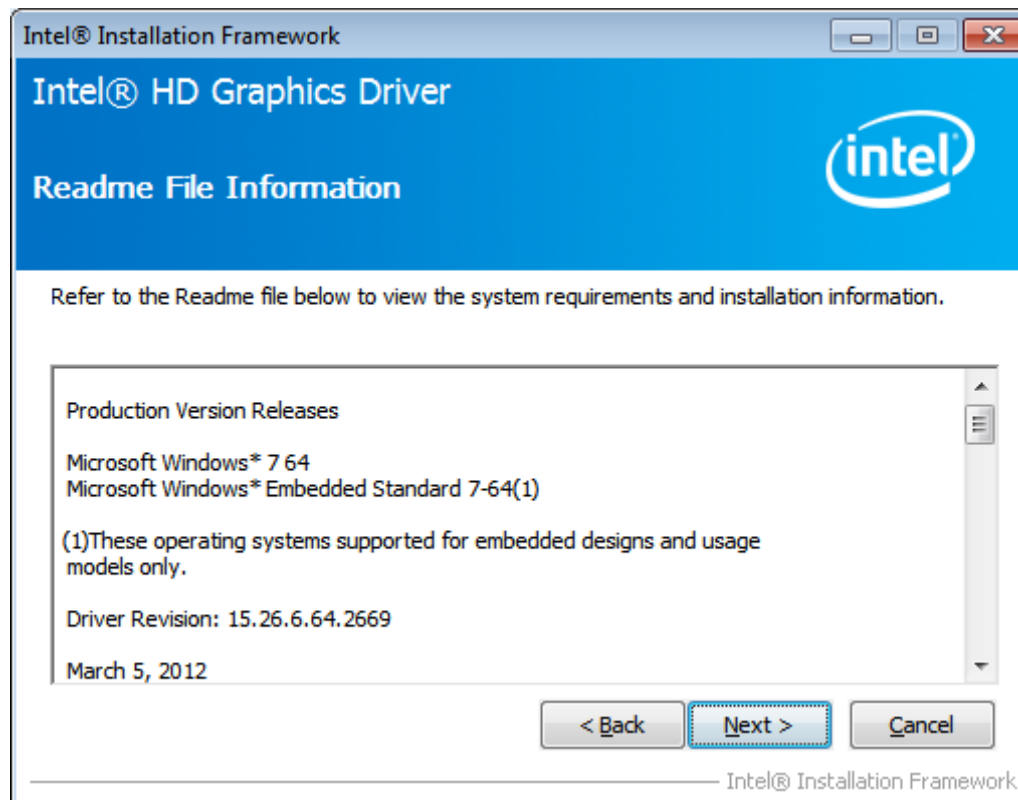

6. On Setup Progress screen, click Next to continue.

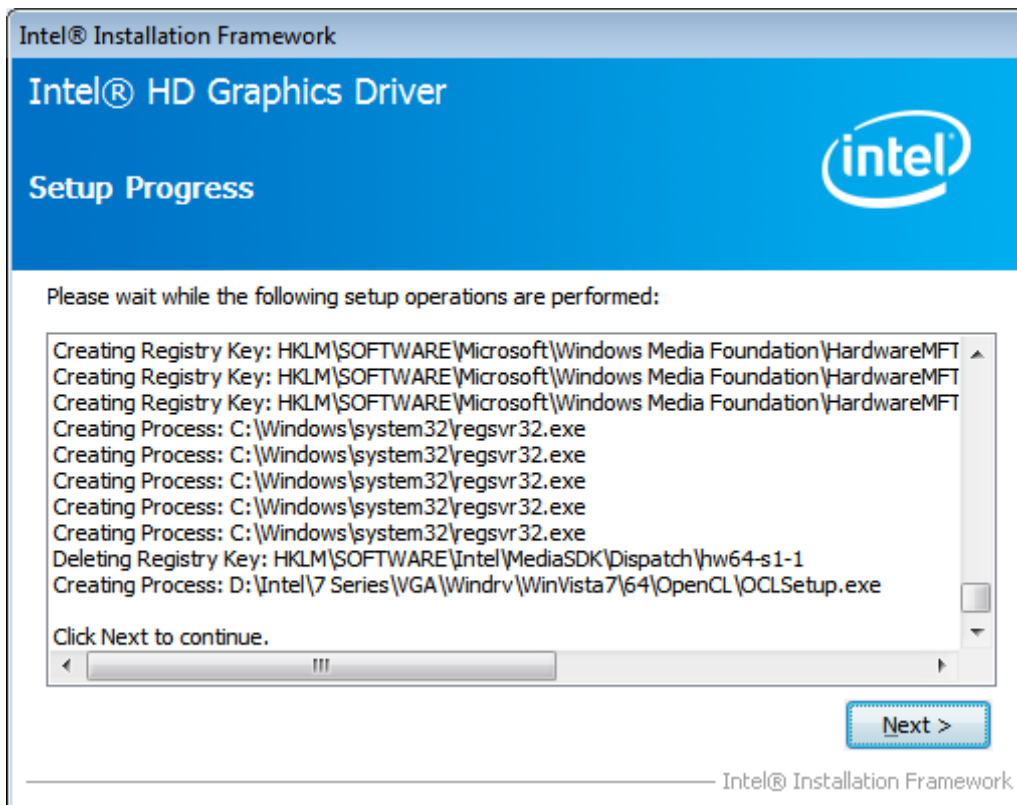

7. Setup complete. Click Finish to restart the computer and for changes to take effect.
DRIVERS INSTALLATION.

Realtek HD Audio Driver Installation

Follow the steps below to install the Realtek HD Audio Drivers.

1. Insert the CD that comes with the board. Click Intel and then Intel(R) Q7 Series Chipset Drivers.

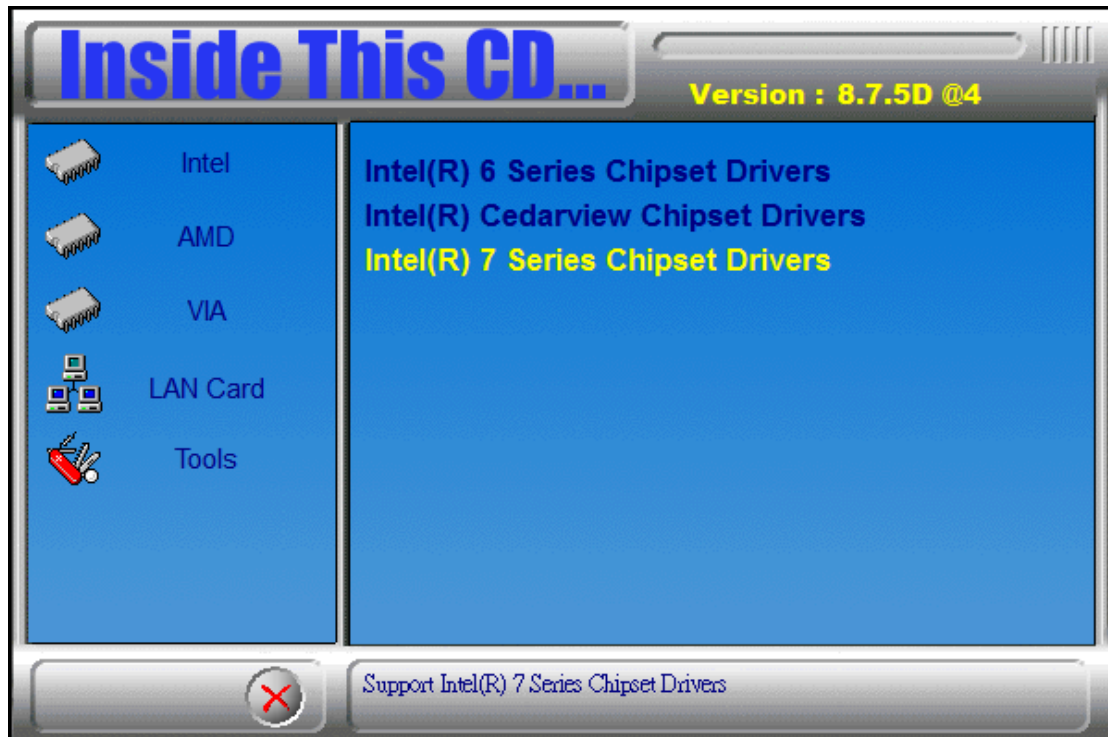

2. Click Realtek High Definition Audio Driver. DRIVERS INSTALLATION

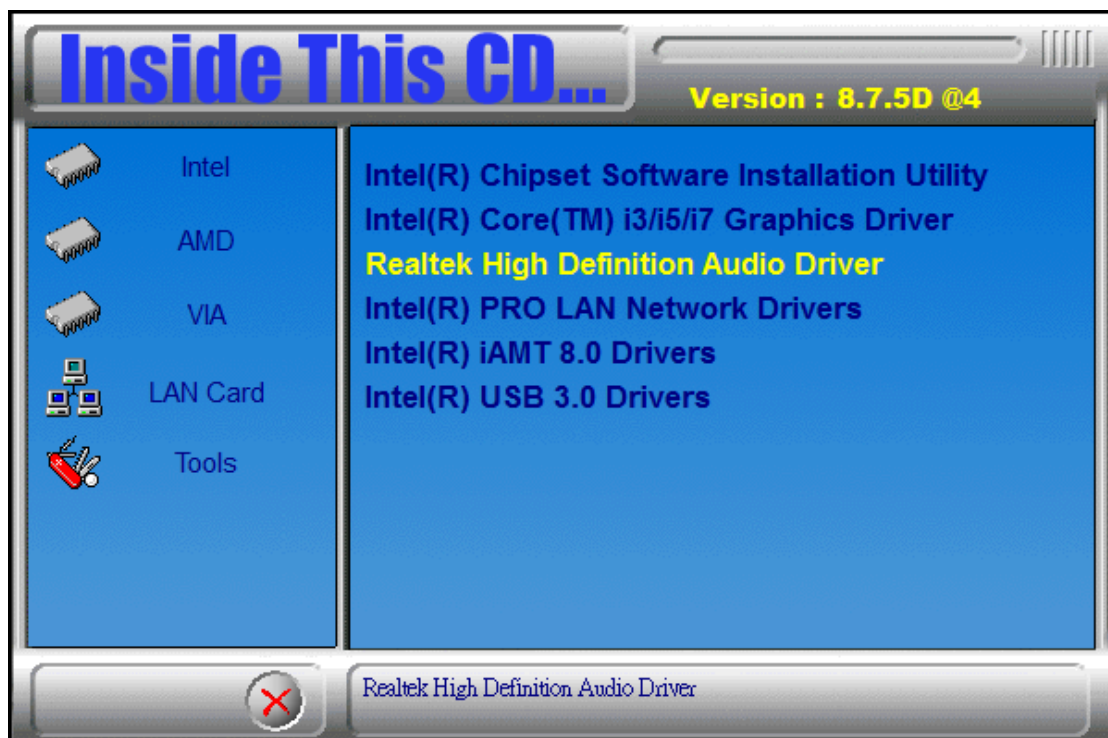

3. On the Welcome to the InstallShield Wizard screen, click Next to proceed with and complete the installation process.

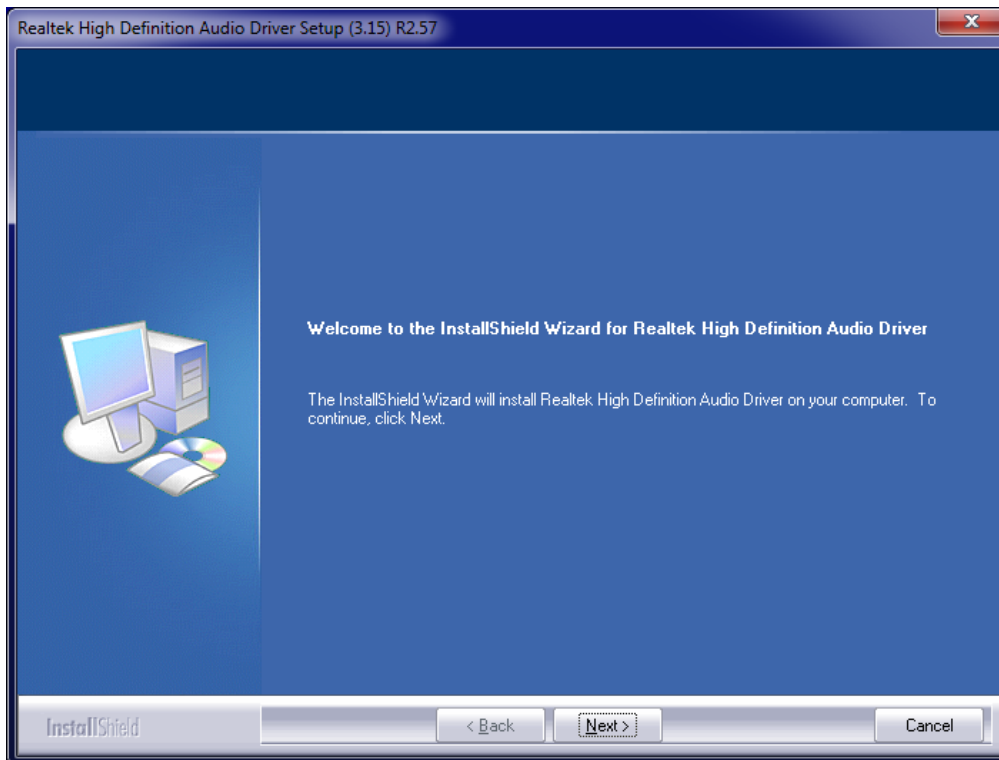

4. The InstallShield Wizard Complete. Click Finish to restart the computer and for changes to take effect. DRIVERS INSTALLATION

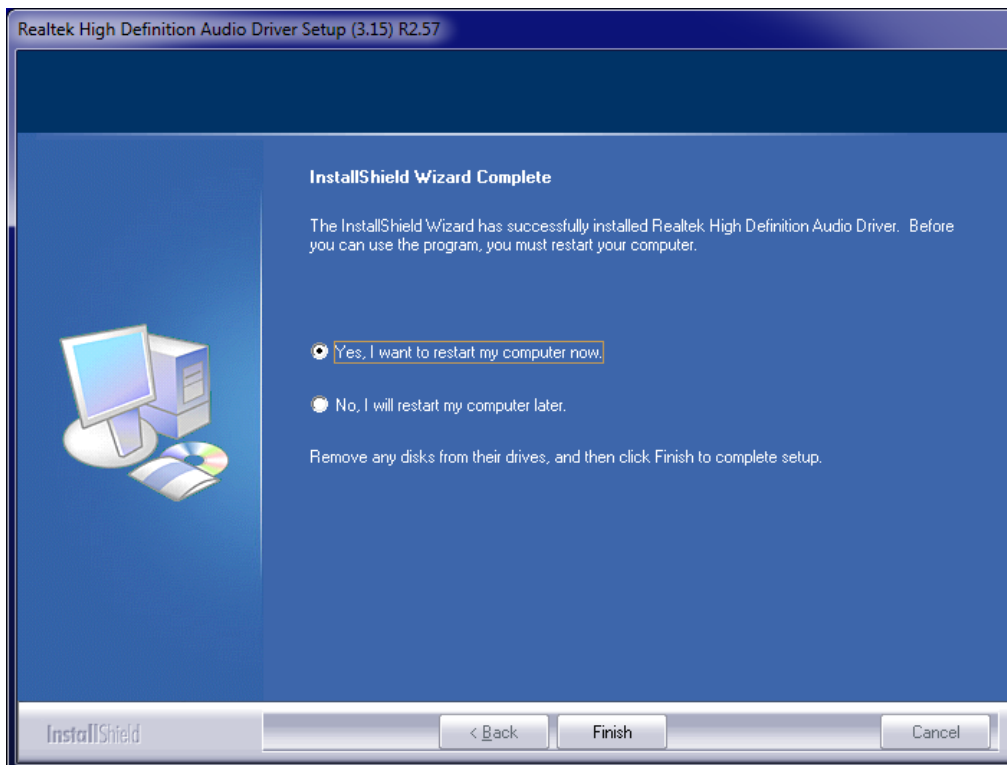

LAN Drivers Installation

1. Insert the CD that comes with the board. Click Intel and then Intel(R) Q7 Series Chipset Drivers.

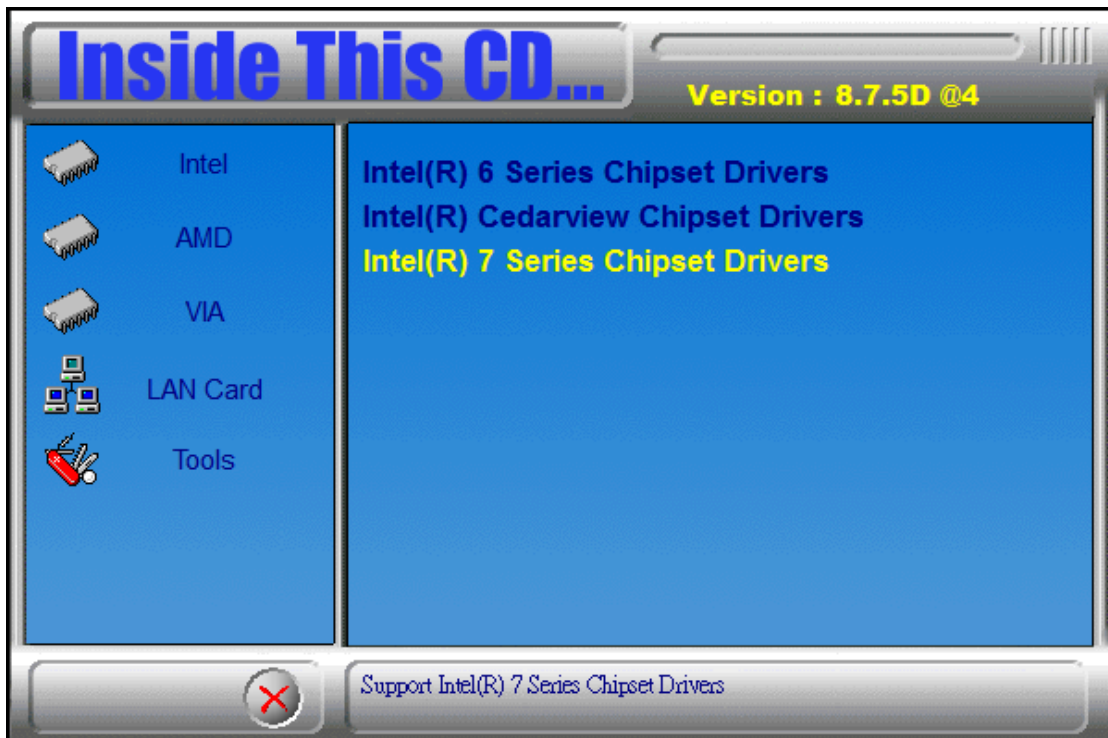

2. Click Intel(R) PRO LAN Network Driver. DRIVERS INSTALLATION



3. Click Install Drivers and Software.

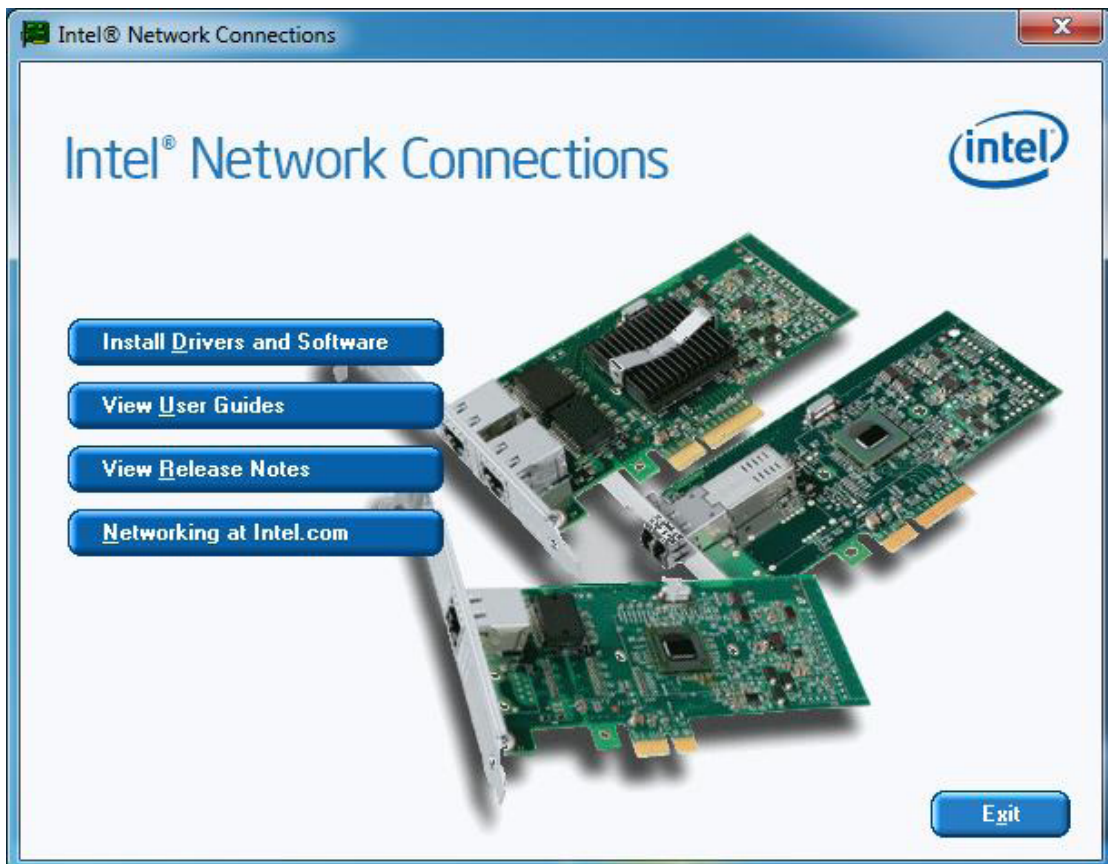

4. Click Next to agree with the license agreement.

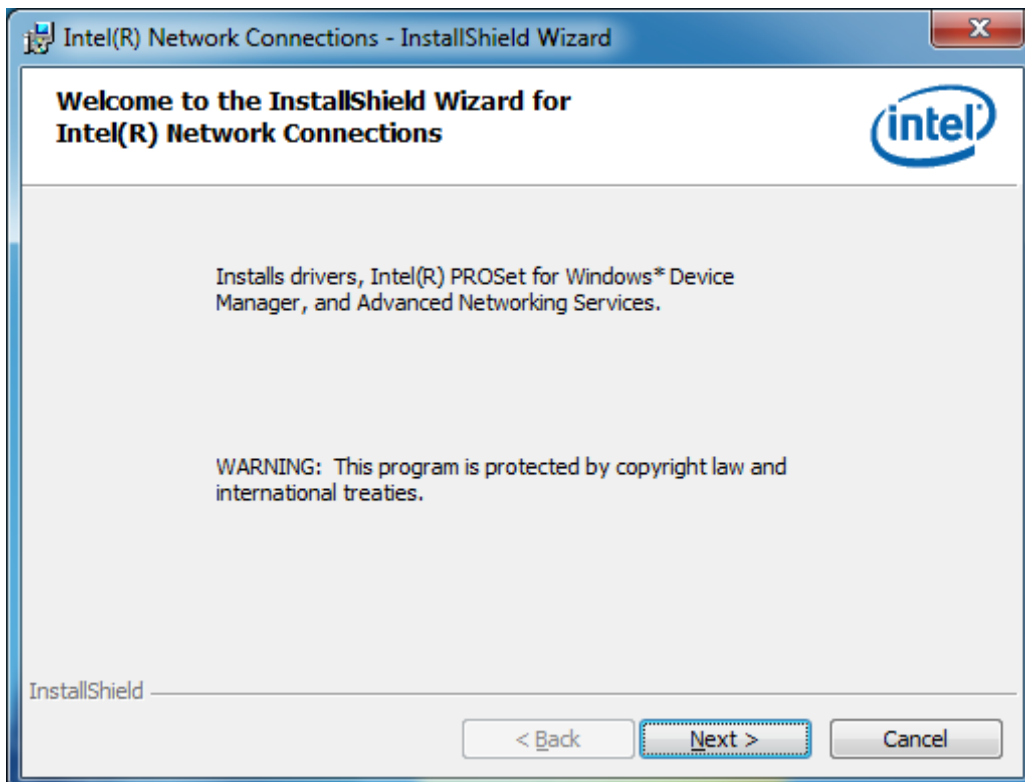

5. Click the checkbox for Drivers in the Setup Options screen to select it and click Next to continue. DRIVERS INSTALLATION



6. The wizard is ready to begin installation. Click Install to begin the installation.

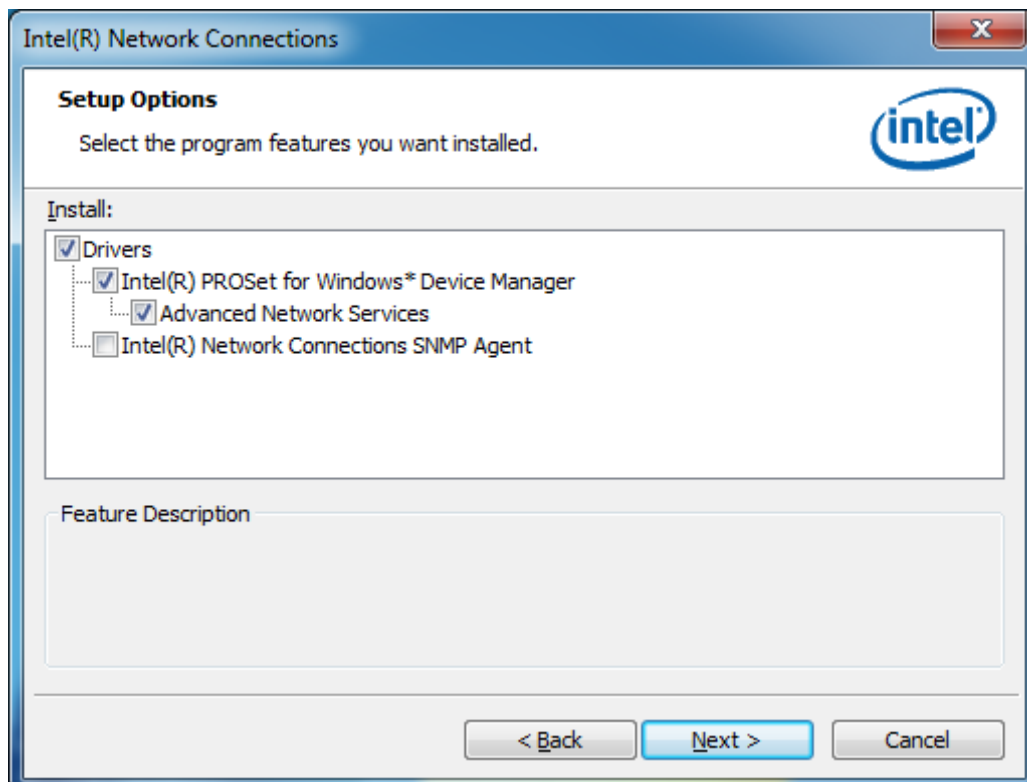

7. When InstallShield Wizard is complete, click Finish. DRIVERS INSTALLATION

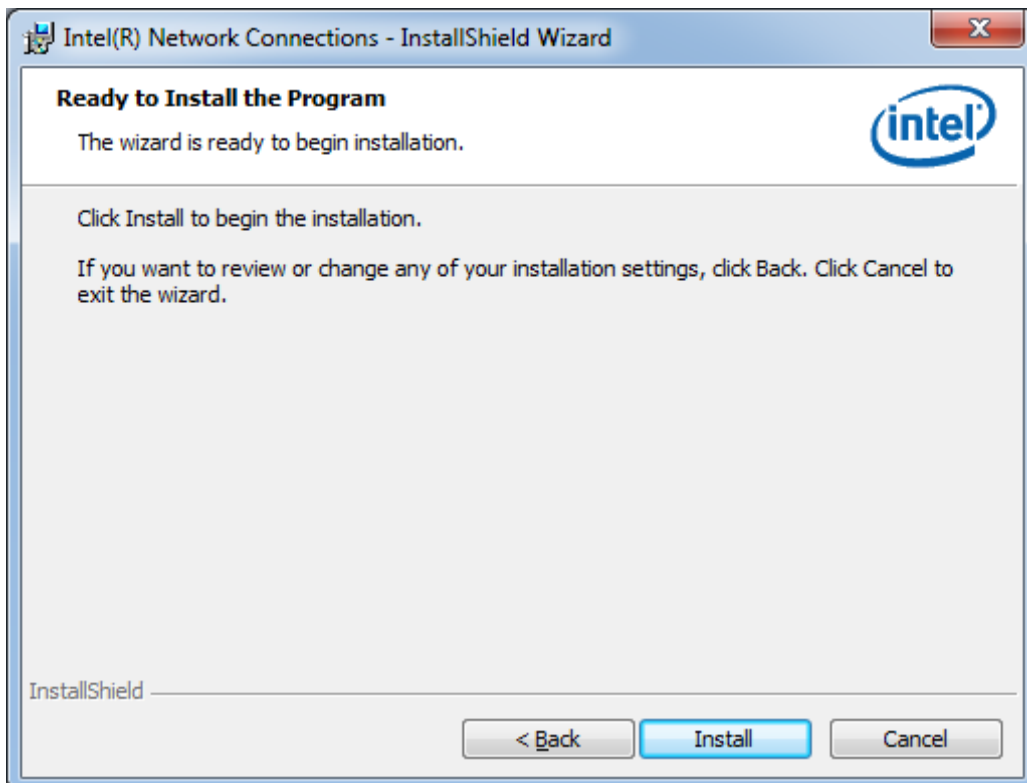

8. When InstallShield Wizard is complete, click Finish.

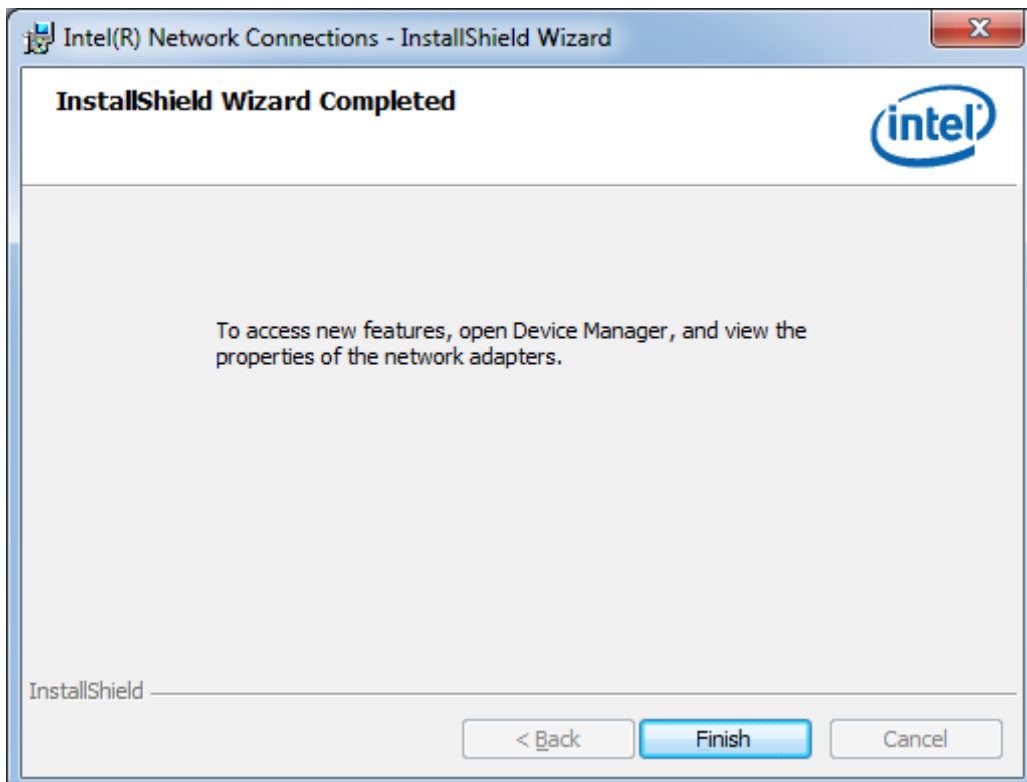

Intel® Management Engine Interface



The following application requires Microsoft .NET Framework 3.5 or later: Intel® Management Engine Components. Please install the latest version of Microsoft .NET Framework from Microsoft Download Center to run this application correctly.

Follow the steps below to install the Intel Management Engine.

1. Insert the CD that comes with the board. Click Intel and then Intel(R) AMT 8.0 Drivers. DRIVERS INSTALLATION



2. When the Welcome screen to the InstallShield Wizard for Intel® Management Engine Components, click the checkbox for Install Intel® Control Center & click Next.

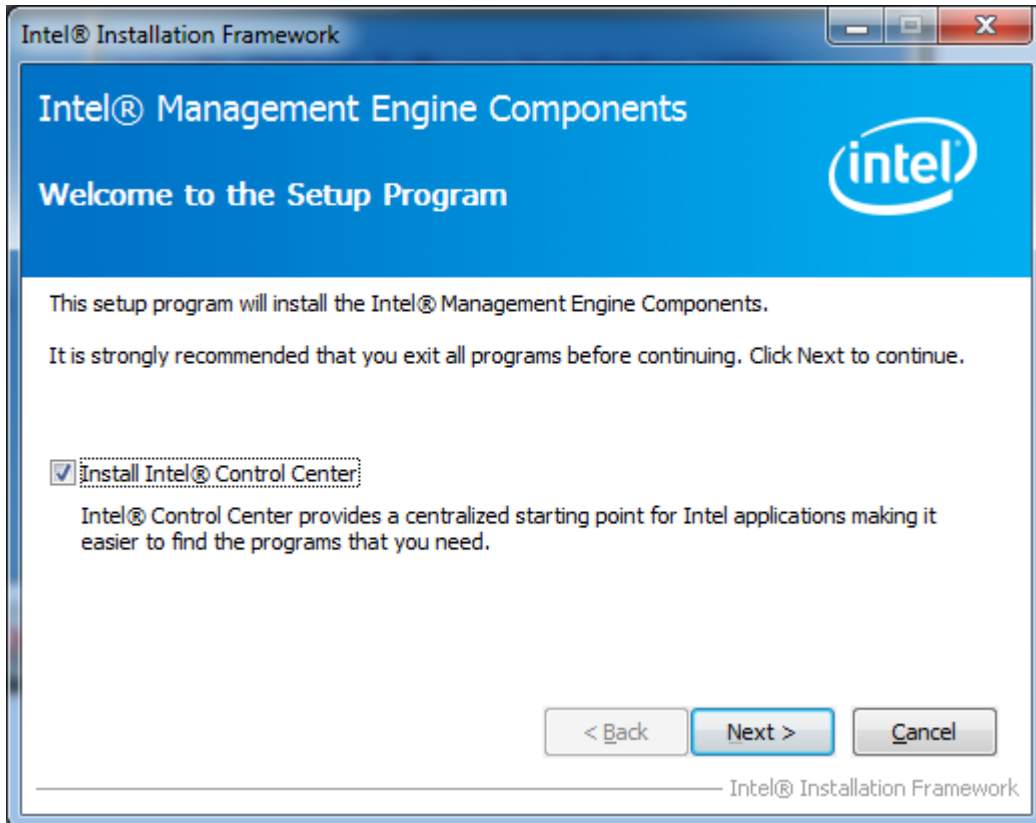

3. Click Yes to to agree with the license agreement. DRIVERS INSTALLATION

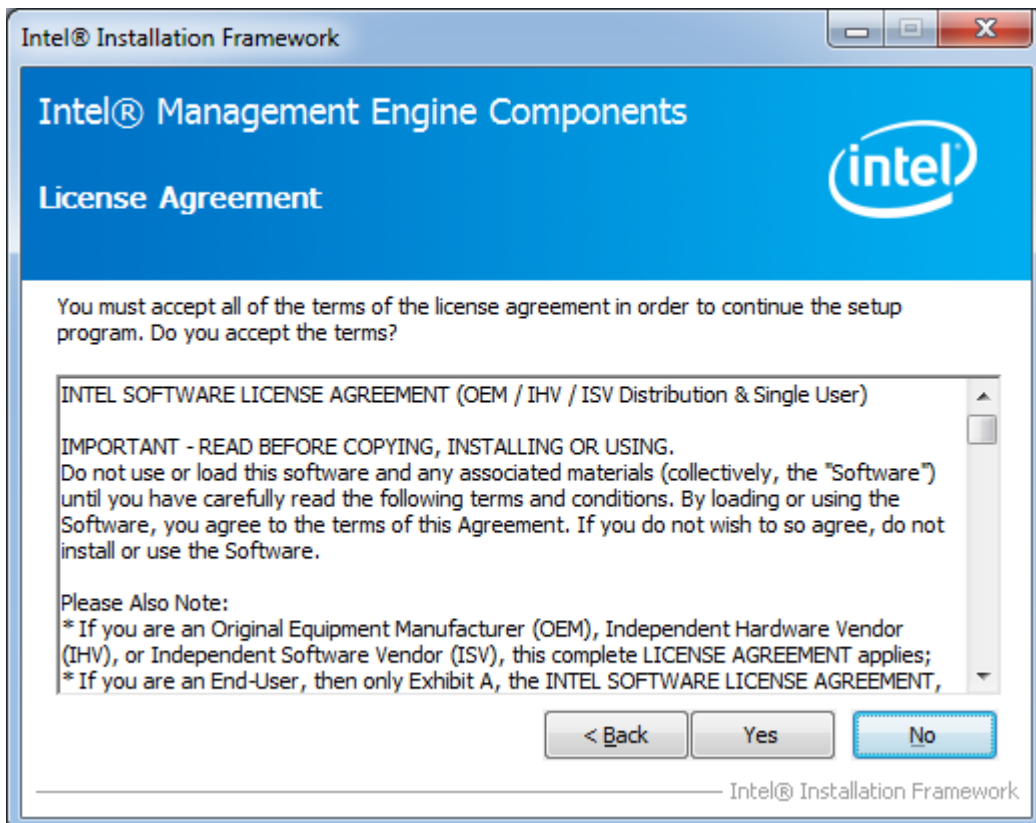

4. When the Setup Progress screen appears, click Next. Then, click Finish when the setup progress has been successfully installed. DRIVERS INSTALLATION

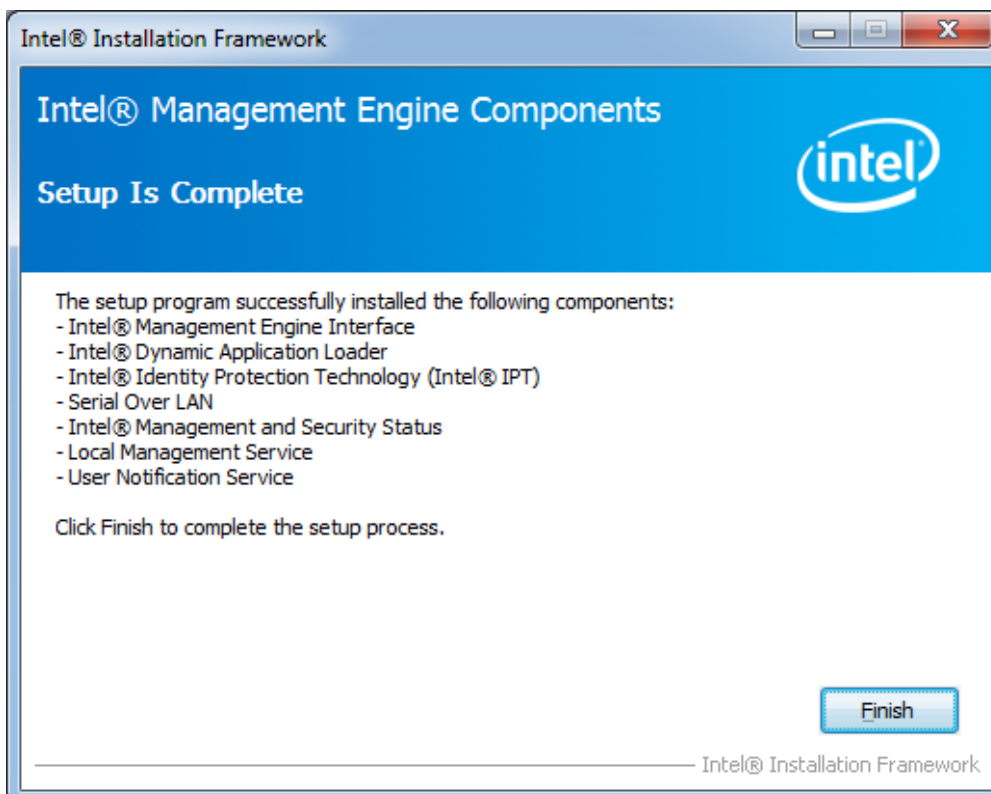
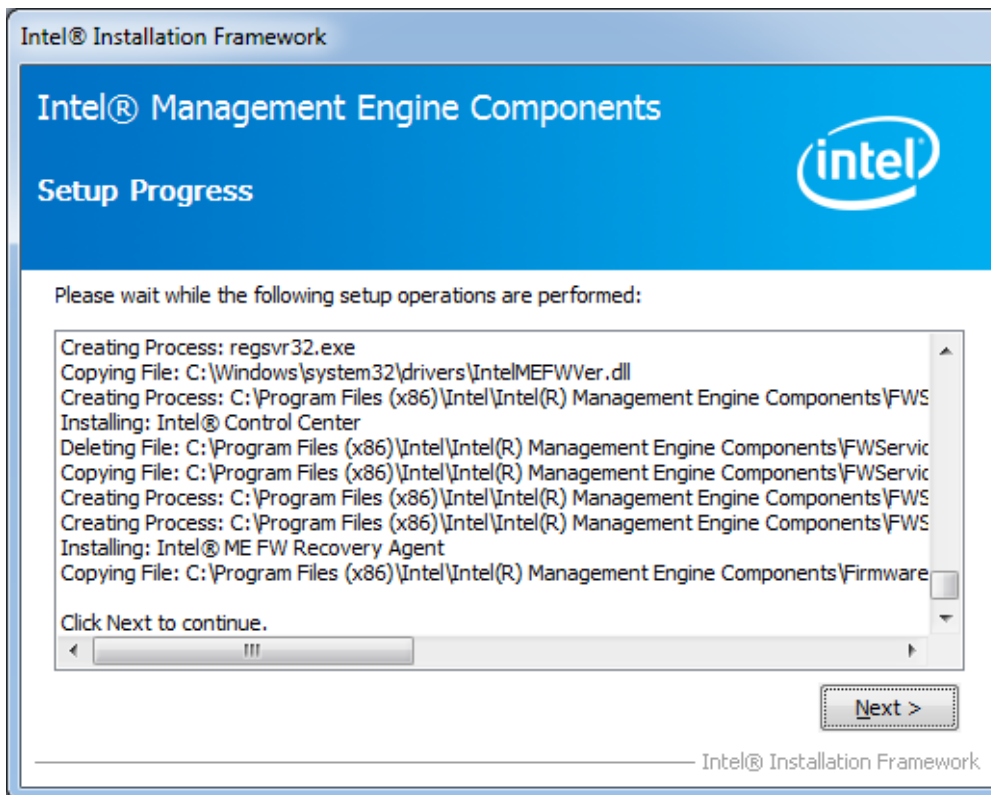

Intel® USB 3.0 Drivers

1. Insert the CD that comes with the board. Click Intel and then Intel(R) Q7 Series Chipset Drivers.



2. Click Intel(R) USB 3.0 Drivers. DRIVERS INSTALLATION



3. When the Welcome screen to the InstallShield Wizard for Intel® USB 3.0 eXtensible Host Controller Driver, click Next.



4. Click Yes to to agree with the license agreement and continue the installation.
5. On the Readme File Information screen, click Next to continue the installation of the Intel® USB 3.0 eXtensible Host Controller Driver.
6. Setup complete. Click Finish to restart the computer and for changes to take effect.