

OXY5315A

3.5" Single Board Computer
User's Manual

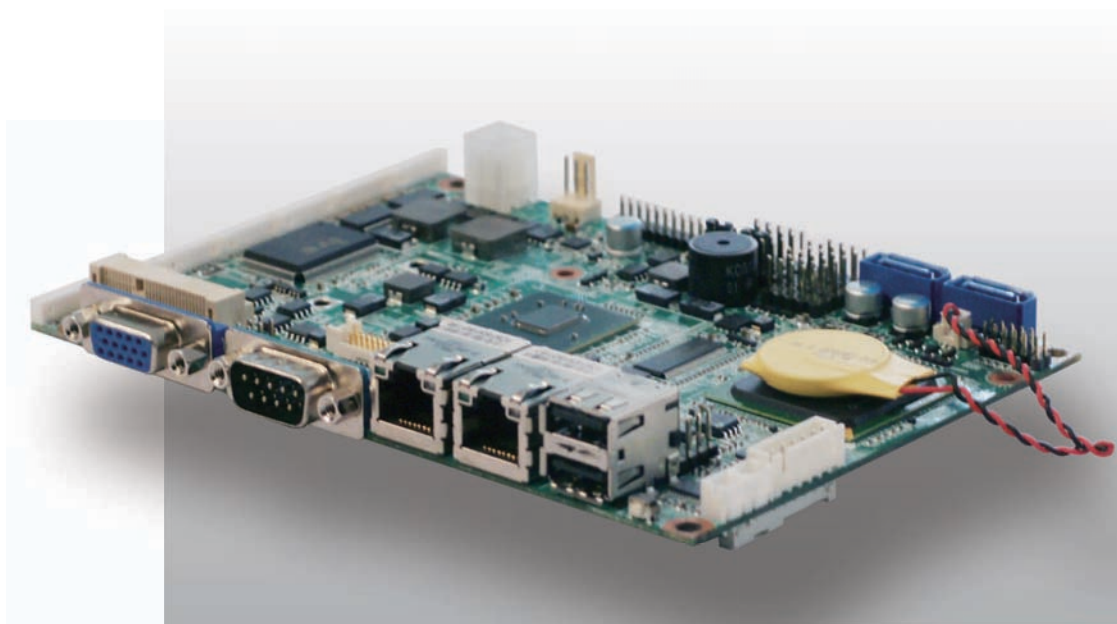

Safety information

Electrical safety

- To prevent electrical shock hazard, disconnect the power cable from the electrical outlet before relocating the system.
- When adding or removing devices to or from the system, ensure that the power cables for the devices are unplugged before the signal cables are connected. If possible, disconnect all power cables from the existing system before you add a device.
- Before connecting or removing signal cables from the motherboard, ensure that all power cables are unplugged.
- Seek professional assistance before using an adapter or extension cord. These devices could interrupt the grounding circuit.
- Make sure that your power supply is set to the correct voltage in your area.
- If you are not sure about the voltage of the electrical outlet you are using, contact your local power company.
- If the power supply is broken, do not try to fix it by yourself. Contact a qualified service technician or your local distributor.

Operation safety

- Before installing the motherboard and adding devices on it, carefully read all the manuals that came with the package.
- Before using the product, make sure all cables are correctly connected and the power cables are not damaged. If you detect any damage, contact your dealer immediately.
- To avoid short circuits, keep paper clips, screws, and staples away from connectors, slots, sockets and circuitry.
- Avoid dust, humidity, and temperature extremes. Do not place the product in any area where it may become wet.
- Place the product on a stable surface.
- If you encounter any technical problems with the product, contact your local distributor

Statement

- All rights reserved. No part of this publication may be reproduced in any form or by any means, without prior written permission from the publisher.
- All trademarks are the properties of the respective owners.
- All product specifications are subject to change without prior notice

Revision

Revision	Date (dd.mm.yyyy)	Changes
Version 1.0	31.07.2011	Initial release
Version 1.1	05.09.2011	<ul style="list-style-type: none"> • Updated Packing list for Cable kit • Modified 3P Clear CMOS to 2P • Removed JUSB_01 • Removed JCOMPWR1-6
Version 1.2	23.02.2012	➤ Updated SK201 Installation Guide

Packing list

- OXY5315A 3.5" SBC
- Driver CD
- Quick Installation Guide
- User's Manual
- Fanless Thermal Module(Optional)
- Cable kit with as below cable(Optional)

Item list	Product description	Quantity	Ordering P/N
Audio Cable	L-IN+MIC+L-OUT ψ 3.5 Phone JACK 180D to XH-6 1x6P P:2.54mm 180D, L:150mm Lead Free	1	0C50200AUDIO000L
SATA Cable	7P + JACKET W/LOCK Female 帶鐵彈片 P:1.27mm 180D L:200mm Lead Free	1	0C50200SATA0000L
LPT Cable	DB25 D-SUB w/bracket(附 2PCS 六角螺絲) Female 25P 180D to IDC 2*13P P:2.00mm, L:205mm 180D LEAD FREE	1	0C5030010008010L
KB/MS Cable	KB+MS MD-6S Female 6P to 6008H 2x3pin P:2.54mm 杜邦 Female 180D, L:170mm LEAD FREE	1	0C50200KBMSPS20L
COM Cable	Male 180D to 51021-000(Molex1.25-10P)1x10P,P:1.25mm ,180D, L:300mm TUBE:200mm LEAD FREE	1	0C5020010008010L



If any of the above items is damaged or missing, please contact your local distributor.

Table of Contents

Safety information	1
<i>Electrical safety</i>	1
<i>Operation safety</i>	1
<i>Statement</i>	1
<i>Revision</i>	2
<i>Packing list</i>	2
Chapter 1: Product Information	6
1.1 <i>Block Diagram</i>	6
1.2 <i>Key Features</i>	7
1.3 <i>Board Placement</i>	8
1.4 <i>Onboard Connector List</i>	9
1.5 <i>Mechanical Drawings</i>	10
2.1 <i>Jumper Settings</i>	11
JCMOS1: Clear CMOS Jumper Setting	11
PSON1: ATX/AT mode Selection	11
2.2 <i>Onboard Connector Pin Assignment</i>	12
MPCIE1 Mini PCIE slots V1.2	12
ATX1 DC Power Input Connector.....	12
Digital I/O Pin Header	13
COM2~4 RS-232 Port (1x10 pin Wafer).....	13
COM5~8 RS-232 Port Wafer	13
LPT1 Parallel Port Pin Header.....	14
SPD/IF output pin Header	14
AUDIO1 Audio Output Wafer	14
AMP_R1 Audio AMP Right Output Wafer	14
AMP_L1 Audio AMP Left Output Wafer	14
DDR3_1 DDR3 Memory DIMM Slot	15
CPU/System FAN	15
FD1 CF Type II Connector	16
FP1 Front Panel 1 Pin Header	16
FP2 Front Panel 2 Pin Header	17
SATA1, SATA2 Serial ATA 2.0 Connector	17
USB2,USB3,USB4 USB2.0 Pin Header.....	17
JTAG1 TAG Port Box Header	17
JLVDS1 18 bit LVDS Panel Connector	18
KBMS1 KB/MS Pin Header.....	18
JBKL1 Panel Backlight Wafer	18
COM1 (RS-232/422/485 Port A DB-9 Connector).....	18
LAN1 , LAN2 10/100/1000 Ethernet RJ-45 Connector	19
VGA1 DSUB 15 pin Connector	19
USB1 2-Stack USB2.0 Type A Connector	19
Chapter 3: Getting Started.....	20

3.1 Installing System Memory.....	20
3.2 Installing the CF card.....	20
3.3 Driver Installation	21
Chapter 4: AMI BIOS UTILITY	22
4.1 Starting	22
4.2 Navigation Keys	22
4.3 Main Menu	23
SATA 1 Setup	24
SATA 1 (LBA/Large Mode).....	24
SATA 1 (DMA Mode).....	25
SATA 2 Setup	26
SATA 2 (LBA/Large Mode).....	26
SATA 2 (LBA/Large Mode).....	27
S.M.A.R.T for SATA 2.....	27
CF Setup	28
CF setup (LBA/Large Mode)	28
CF (DMA Mode)	29
S.M.A.R.T for CF.....	30
System Information.....	31
4.4 Advanced Menu	32
Onboard I/O Configuration	32
Onboard Peripherals Configuration	33
USB Function.....	34
USB Device Legacy Support.....	34
Audio Controller.....	35
Onboard LAN1 Controller.....	35
Onboard LAN1 OPTROM	36
Onboard LAN2 Controller.....	36
Onboard LAN2 OPTROM	37
Onboard Mini-PCIE Controller.....	37
On-Chip ATA Devices	38
ATA/IDE Configuration.....	38
Configure SATA as.....	39
Hardware Health Configuration	40
4.5 Boot Setting	41
Quick Boot.....	41
Full Screen Logo Display.....	41
Bootup Num-lock	42
Wait For 'F1' If Error.....	42
Hit 'Del' Message Display	43
4.6 Chipset Setting	43
Initial Graphic Adapter	44
Internal Graphic Mode Select	44
Hyper Threading Technology.....	45
Video Function Configuration	46
DVMT Model Select	47
DVMT/Fixed Memory.....	47
Boot Display Device.....	48
Flat Panel Type	48
Panel Backlight voltage	49
4.7 Power Management Setting	49

ACPI Function	49
ACPI Standby State	50
Repost Video on S3 Resume	50
Restore on AC Power Loss	51
Resume From S3 By USB Device.....	52
Resume By LAN Device	52
Resume By RTC Alarm	53
4.8 Security Setting	53
Change Supervisor Password	53
Change User Password	54
4.9 Exit Setting	55
Save Changes and Exit.....	55
Discard Changes and Exit	56
Discard Changes	57
Load Optimal Defaults.....	58
Load Failsafe Defaults.....	59
 APPENDIX A Watchdog Timer Setting	 61
 APPENDIX B DIGITAL I/O	 63
 APPENDIX C Daughter Board SK201 Installation Guide	 65
<i>Main Board: OXY5315A</i>	<i>65</i>
<i>Daughter Board: SK201.....</i>	<i>66</i>
<i>24-bits LVDS solution: OXY5315A + SK201</i>	<i>67</i>

Chapter 1: Product Information

1.1 Block Diagram

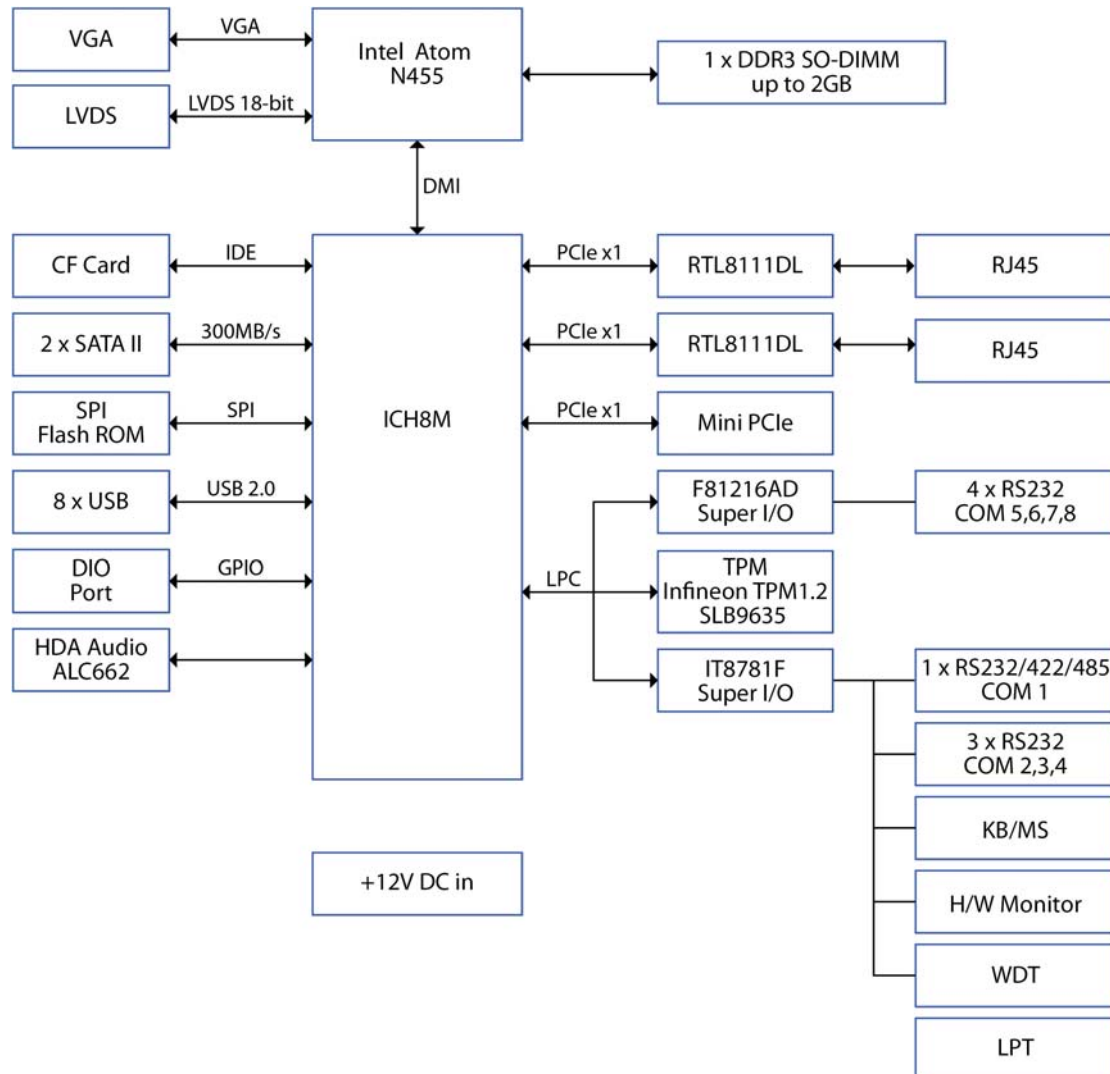

1.2 Key Features

Processor & System	
CPU Type	Intel Atom Pineview-M N455 CPU onboard (45nm, 1.66GHz, 512KB L2 Cache)
Chipset	Intel® ICH8M
Memory Type	DDR3 800 SO DIMM (Max is 2GB)
BIOS	8MB SPI Flash
Super I/O	ITE8781F
Watchdog	1-255 sec. or 1-255 min. software programmable and can be generate system reset
Expansion Slot	
CF Socket	CF Type I/II CF Socket
SATA Port	2 x SATAII (3Gb/s)
Mini PCIe Socket	Supports GPRS/GSM Mini PCIe Devices
Display	
Chipset	Integrated Intel® GMA3150 Graphic engine
Memory Size	Intel® DVMT 4.0 compliant
Onboard VGA	Yes, Max.: SXGA 2048 x 1536
LVDS	18-bit single channel LVDS 24-bit single/dual channel LVDS (By LVDS card)
Dual Displays Capability	VGA+LVDS
Audio	
Codec	ALC662 High Definition Audio Codec
Ethernet	
Controller	Dual Realtek RTL8111DL PCIex1 Bus
Disable LAN through BIOS	Yes
WOL	Yes
Boot from LAN	Yes for PXE
Rear I/O	
VGA	1 Port
Ethernet	2 Port
COM	1 x RS232/422/485 with 5V/12V selectable (COM1)
USB 1.1/2.0	2 Port
Internal I/O	
SATA	2 x SATAII (3Gb/s)
USB	Total is 8 x USB Port • 2 Port on Front I/O • 6 Port by 2x5 pin header
COM	Total is 8xCOM port • COM1 belongs to D-Sub 9pin and supports RS-232/422/485 • COM2~COM8 belongs to 10pin Wafer connector and supports RS232 only
SPDIF	1x5 Pin header
Digital I/O	2x5 Pin header (4in and 4 out)

Parallel port	2x13 Pin header
Mechanical and Environment	
Form Factor	3.5" SBC
Power Type	ATX 2x2 pin Power connector
Voltage	+12V single voltage in
Dimension	146mm x 102mm
Operating Temp.	-20°C ~ 70°C
Storage Temp.	-20°C ~ 80°C
Relative humidity	10% to 90%, non-condensing

All specifications and photos are subject to change without notice

1.3 Board Placement

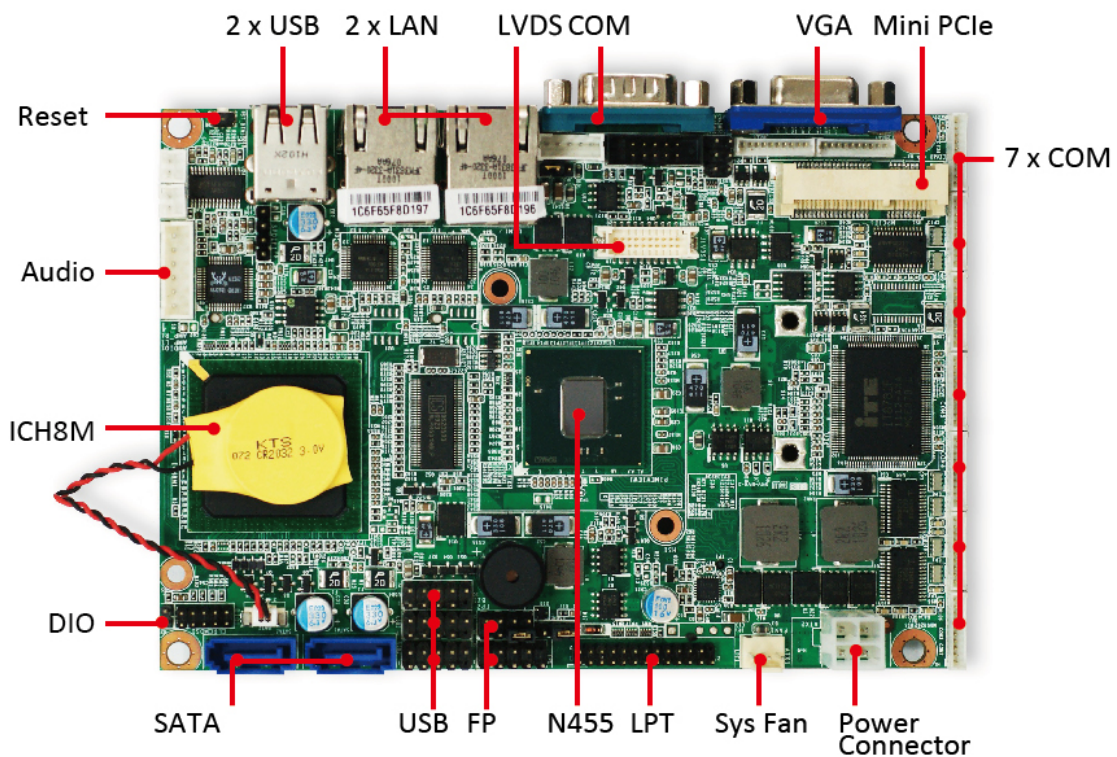

1.4 Onboard Connector List

Label	Function
MPCIE1	Mini PCIe Connector
ATX2	Power Input Connector
DIO1	Digital Input / Output Pin Header
COM2	RS-232 Port B With Power Wafer
COM3	RS-232 Port C With Power Wafer
COM4	RS-232 Port D With Power Wafer
COM5	RS-232 Port E With Power Wafer
COM6	RS-232 Port F With Power Wafer
COM7	RS-232 Port G With Power Wafer
COM8	RS-232 Port H With Power Wafer
LPT1	Parallel Port Pin Header
SPDIF1	SPD/IF Output Pin Header
AUDIO1	AUDIO OUT Wafer
AMP_R1	Audio AMP Right Output Wafer
AMP_L1	Audio AMP Left Output Wafer
DDR3_1	DDR3 Memory SO DIMM Socket
FAN1	CPU FAN Wafer
CFD1	CF Type II Connector
FP1	Front Panel 1 Pin Header
FP2	Front Panel 2 Pin Header
SATA1	Serial ATA 2.0 Connector
SATA2	Serial ATA 2.0 Connector
USB2	USB2.0 Port 3, 4 Pin Header
USB3	USB2.0 Port 5, 6 Pin Header
USB4	USB2.0 Port 7, 8 Pin Header
JTAG1	Intel JTAG Box Header
JLVDS1	LVDS Panel Connector
KBMS1	KB/MS Pin Header
JBKL1	Panel Backlight Wafer

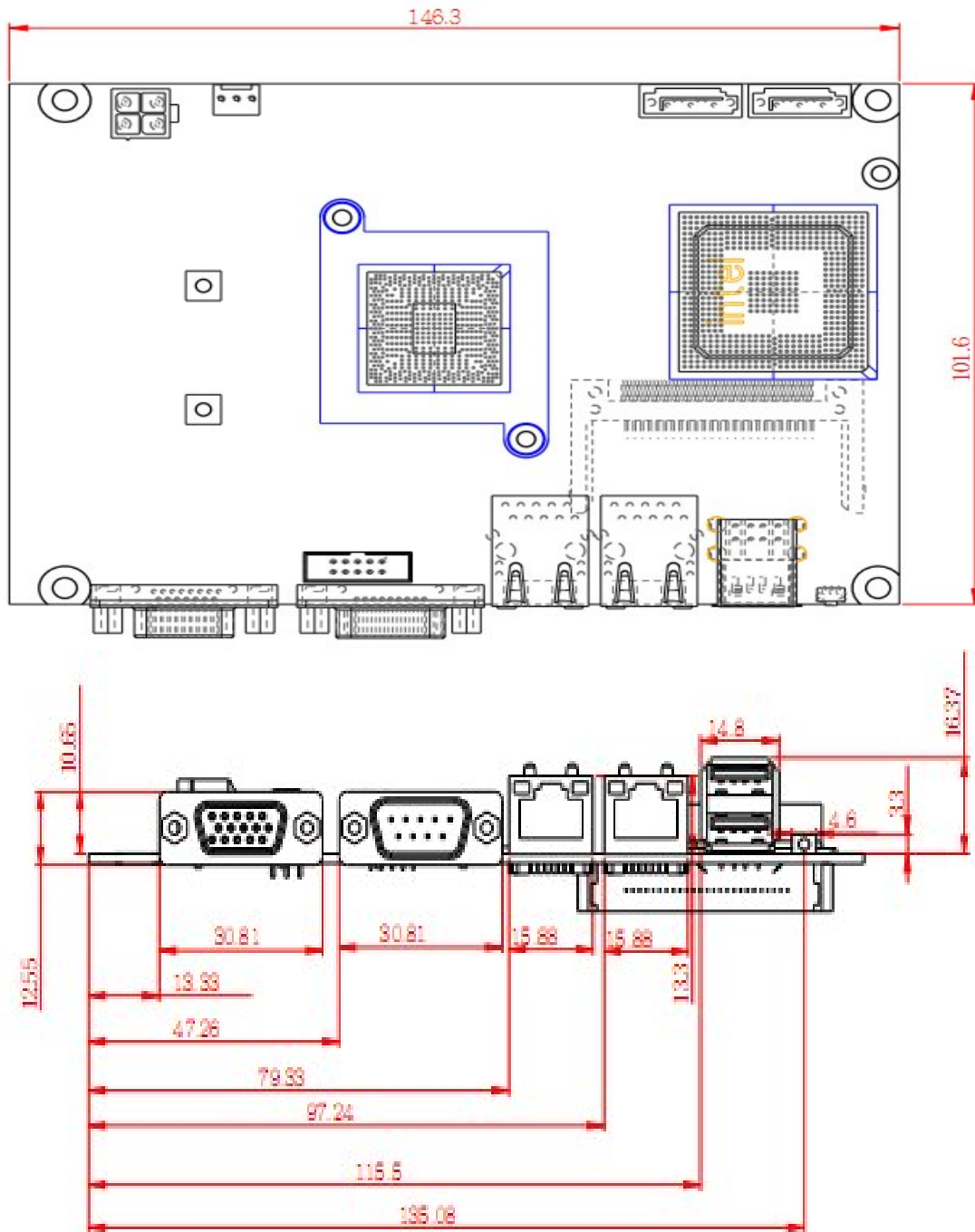

1.5 Mechanical Drawings





Chapter 2: Jumpers and Connectors

2.1 Jumper Settings

JCMOS1: Clear CMOS Jumper Setting

Jumper	Function description	Setting
1-2	Normal Operation	
2-3	Clear CMOS	
Default setting is 1-2		

PSON1: ATX/AT mode Selection

Jumper	Function description	Setting
1-2	AT Mode	<div style="display: flex; align-items: center;"> <div style="margin-right: 5px;">1</div> <div style="margin-right: 5px;">2</div> <div style="margin-right: 5px;">3</div>  </div>
2-3	ATX Mode	<div style="display: flex; align-items: center;"> <div style="margin-right: 5px;">1</div> <div style="margin-right: 5px;">2</div> <div style="margin-right: 5px;">3</div>  </div>
Default setting is 2-3		

2.2 Onboard Connector Pin Assignment

MPCIE1 Mini PCIE slots V1.2

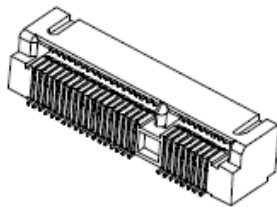

Signal Name	Pin	Pin	Signal Name
PCIE_WAKE#	1	2	*+3.3VSB
NC	3	4	GND
NC	5	6	+1.5V
NC	7	8	UIM_PWR
GND	9	10	UIM_DATA
CLK100_MPCIE1#/2#	11	12	UIM_CLK
CLK100_MPCIE1/2	13	14	UIM_RESET
GND	15	16	UIM_VPP
NC	17	18	GND
NC	19	20	MPCIE1/2_EN
GND	21	22	RST_PCIE#
PCIE_RX2-β-	23	24	+3.3VSB
PCIE_RX2+/β+	25	26	GND
GND	27	28	+1.5V
GND	29	30	SB_SMB_CLK
PCIE_TX2-β-	31	32	SB_SMB_DAT
PCIE_TX2+/β+	33	34	GND
GND	35	36	USBN
GND	37	38	USBP
+3.3VSB	39	40	GND
+3.3VSB	41	42	LED_WLAN#
GND	43	44	LED_WLAN#
NC	45	46	LED_WLAN#
NC	47	48	+1.5v
NC	49	50	GND
NC	51	52	*+3.3VSB

ATX1 DC Power Input Connector



Pin	Signal	Pin	Signal
1	GND	2	GND
3	+12V	4	+12V

2x2 pin power connector with 90 degrees (Optional feature for OXY5315A)

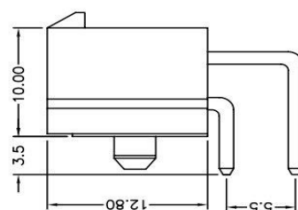
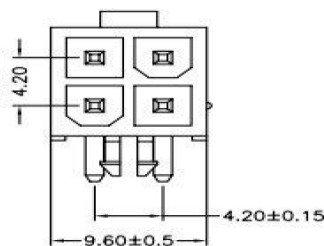

Digital I/O Pin Header

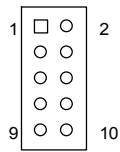

Pin	Signal	Pin	Signal
1	Digital Output 0	2	Digital Input 0
3	Digital Output 1	4	Digital Input 1
5	Digital Output 2	6	Digital Input 2
7	Digital Output 3	8	Digital Input 3
9	+5V	10	GND

COM2~4 RS-232 Port (1x10 pin Wafer)

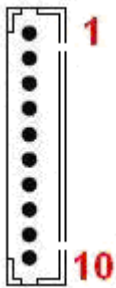

Pin	Signal
1	DCD, Data carrier detect
2	DSR, Data set ready
3	RXD, Receive data
4	RTS, Request to send
5	TXD, Transmit data
6	CTS, Clear to send
7	DTR, Data terminal ready
8	RI, Ring indicator (Can choose +5V or +12V)
9	GND, ground
10	+5V

COM5~8 RS-232 Port Wafer

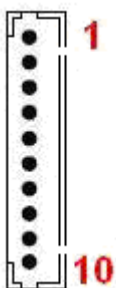

Pin	Signal
1	DCD, Data carrier detect
2	DSR, Data set ready
3	RXD, Receive data
4	RTS, Request to send
5	TXD, Transmit data
6	CTS, Clear to send
7	DTR, Data terminal ready
8	RI Ring
9	GND, ground
10	+5V

LPT1 Parallel Port Pin Header

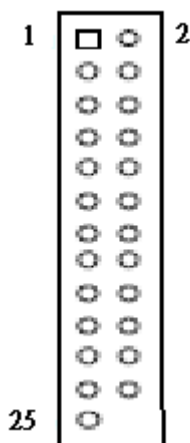

Signal	Pin	Pin	Signal
Line printer strobe	1	2	AutoFeed
PD0, parallel data 0	3	4	Error
PD1, parallel data 1	5	6	Initialize
PD2, parallel data 2	7	8	Select In
PD3, parallel data 3	9	10	Ground
PD4, parallel data 4	11	12	Ground
PD5, parallel data 5	13	14	Ground
PD6, parallel data 6	15	16	Ground
PD7, parallel data 7	17	18	Ground
ACK, acknowledge	19	20	Ground
Busy	21	22	Ground
Paper empty	23	24	Ground
Select	25		

SPD/IF output pin Header



Pin	Signal Name
1	SPDIF_IN
2	GND
3	SPDIF_OUT
4	GND

AUDIO1 Audio Output Wafer

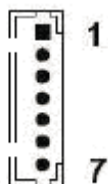

Pin	Signal
1	LOUT_R
2	GND
3	LOUT_L
4	LIN_R
5	MIC
6	LIN_L

AMP_R1 Audio AMP Right Output Wafer

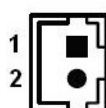

Pin	Signal Name
1	Speaker+
2	Speaker-

AMP_L1 Audio AMP Left Output Wafer

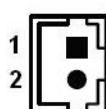

Pin	Signal Name
1	Speaker+
2	Speaker-

DDR3_1 DDR3 Memory DIMM Slot

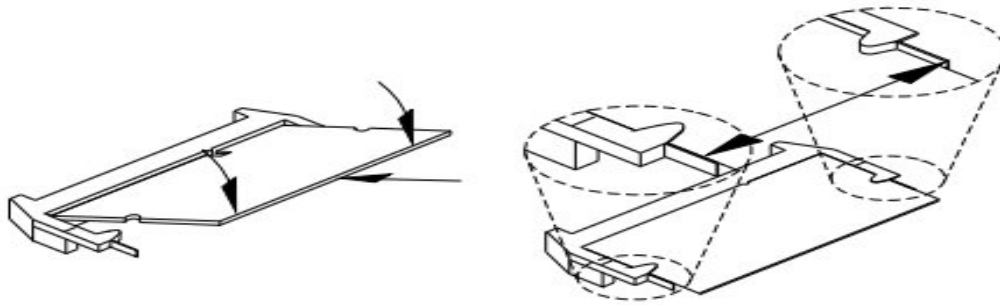

CPU/System FAN

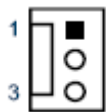

Pin	Signal
1	GND
2	+12V
3	FAN_RPM

FD1 CF Type II Connector

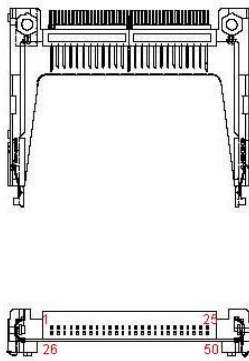

Signal Name	Pin	Pin	Signal Name
GND	1	26	GND
IDE Data 3	2	27	IDE Data 11
IDE Data 4	3	28	IDE Data 12
IDE Data 5	4	29	IDE Data 13
IDE Data 6	5	30	IDE Data 14
IDE Data 7	6	31	IDE Data 15
IDE Chip select 1#	7	32	IDE Chip select 3#
GND	8	33	GND
GND	9	34	IDEIOR#
GND	10	35	IDEIOW#
GND	11	36	+5V
GND	12	37	IDEIRQ
+5V	13	38	+5V
GND	14	39	PCSEL
GND	15	40	NC
GND	16	41	Reset IDE
GND	17	42	IDEIORDY
SDA2	18	43	DREQ
IDE Address 1	19	44	DACK#
IDE Address 0	20	45	IDE activity
IDE Data 0	21	46	PDIAG#
IDE Data 1	22	47	IDE Data 8
IDE Data 2	23	48	IDE Data 9
IOIS16#	24	49	IDE Data 10
GND	25	50	GND

FP1 Front Panel 1 Pin Header

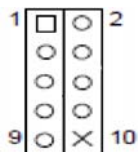

Pin	Signal	Pin	Signal
1	HDD LED +	2	Power LED +
3	HDD LED -	4	Power LED -
5	Reset Button -	6	Power Button +
7	Reset Button +	8	Power Button -
9		10	NC

FP2 Front Panel 2 Pin Header

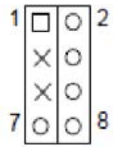

Pin	Signal	Pin	Signal
1	Speaker +	2	SMBus Clock
3	NC	4	SMBus Data -
5	Internal Speaker-	6	GND
7	Speaker -	8	Keyboard Lock

SATAI1, SATA2 Serial ATA 2.0 Connector

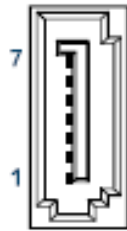

Pin	Signal Name
1	GND
2	TX+
3	TX-
4	GND
5	RX-
6	RX+
7	GND

USB2,USB3,USB4 USB2.0 Pin Header

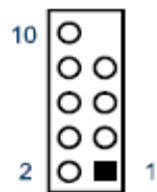

Pin	Signal Name	Pin	Signal Name
1	+5V	2	+5V
3	USB_A-	4	USB_B-
5	USB_A+	6	USB_B+
7	GND	8	GND
9	KEY	10	GND

JTAG1 TAG Port Box Header

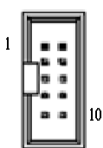

Signal	Pin	Pin	Signal
ITP_TCK	1	2	+3.3V
ITP_TMS	3	4	GND
ITP_TDI	5	6	GND
ITP_TDO	7	8	GND
ITP_RST#	9	10	NC

JLVDS1 18 bit LVDS Panel Connector

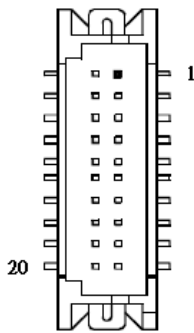

Pin	Signal Name	Pin	Signal Name
2	+5V	1	+3.3V
4	+5V	3	+3.3V
6	LVDS_A0-	5	LVDS_A1-
8	LVDS_A0+	7	LVDS_A1+
10	GND	9	GND
12	LVDS_A2-	11	LVDS_CLK-
14	LVDS_A2+	13	LVDS_CLK+
16	GND	15	GND
18	DDC_DAT	17	+12V
20	DDC_CLK	19	+12V

KBMS1 KB/MS Pin Header

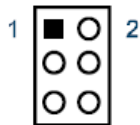

Signal	Pin	Pin	Signal
VCC	1	2	KBDAT
MSDAT	3	4	KBCLK
MSCLK	5	6	GND

JBKL1 Panel Backlight Wafer

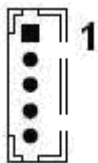

Pin	Signal Name
1	+12V
2	GND
3	BL_EN
4	BL_ADJ
5	+5V

COM1 (RS-232/422/485 Port A DB-9 Connector)

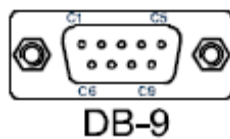

Pin	RS-232	RS-422	Half Duplex RS-485
1	DCD	TX-	DATA-
2	RXD	RX+	NA
3	TXD	TX+	DATA+
4	DTR	RX-	NA
5	GND	GND	GND
6	DSR	NA	NA
7	RTS	NA	NA
8	CTS	NA	NA
9	+5V/+12V/RI	+5V/+12V/NA	+5V/+12V/NA

LAN1 , LAN2 10/100/1000 Ethernet RJ-45 Connector

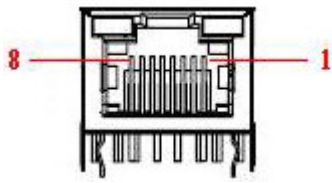

Pin	Signal
1	Tx+
2	Tx-
3	Rx+
4	NC
5	NC
6	Rx-
7	NC
8	NC

VGA1 DSUB 15 pin Connector

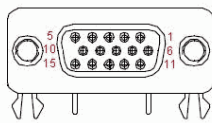

Signal Name	Pin	Pin	Signal Name
Red	1	2	Green
Blue	3	4	NC
GND	5	6	GND
GND	7	8	GND
VCC	9	10	GND
NC	11	12	DDC data
HSYNC	13	14	VSYNC
DDC clock	15		

USB1 2-Stack USB2.0 Type A Connector

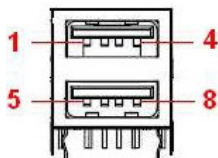

Pin	Signal Name	Pin	Signal Name
1	+5V	5	+5V
2	USB1-	6	USB0-
3	USB1+	7	USB0+
4	GND	8	GND

Chapter 3: Getting Started

This chapter provides information on how to install components to the OXY5315A. Specifically, the installation of memory modules and operating system are explained.

3.1 Installing System Memory

The OXY5315A supports DDR3 800 SO-DIMM.



Disconnect all power supplies to the board before installing a memory module to prevent damage to the board and memory module.

To install a memory module:

1. Located the memory module slots on the motherboard.
2. Push the socket retaining clips outward to unlock the slots.
3. Align the memory module with the socket to make sure the notch aligns with the slot key on the socket.
4. Insert the module firmly into the desired slot until the retaining clips lock and secure the memory module.

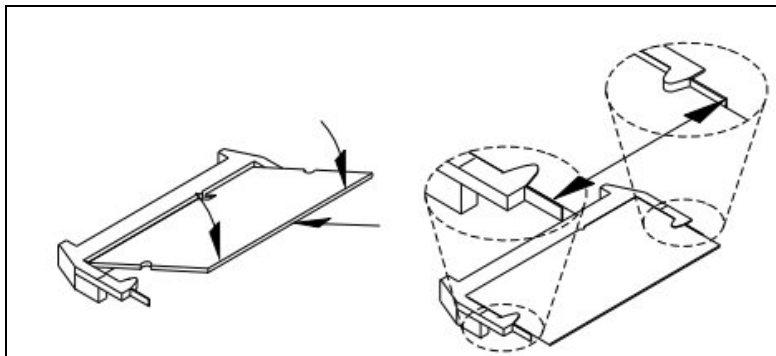

3.2 Installing the CF card

The OXY5315A contains a built-in CF Type II Socket

Step 1: Locate the CF card socket. Locate the CompactFlash® slot.

Step 2: Align the CF card. Align the CompactFlash® card. The label side should be facing away from the board. The grooves on the CompactFlash® slot ensure that the card cannot be inserted the wrong way.

Step 3: Insert the CF card. Push until the CompactFlash® card is firmly seated in the slot

3.3 Driver Installation

The OXY5315A drivers for Windows XP 32-bit are located in the following directories on the Driver CD or can be downloaded from the Perfectron website (<http://www.perfectron.com>):

Follow the instructions below to install the required OXY5315A drivers:

1. Install the Windows operating system before installing any drivers. Most standard I/O device drivers are installed during Windows installation.
2. Install the chipset driver by running the program
X:\OXY5315A Driver\INF\setup.exe. Follow the provided instructions and reboot the computer when instructed.
3. Install the display driver and utilities by running the program
X:\OXY5315A Driver\VGA\WIN2KXP_32\setup.exe. Follow the provided instructions and reboot the computer when instructed.
4. Install the LAN driver by running the program
X:\OXY5315ADriver\LAN\Windows\2000_XP_2003 Server\PRO2KXP.exe.
Follow the provided instructions and reboot the computer, if is required.
5. Install the Audio driver by running the program
X:\OXY5315A Driver\Audio\32bit\2K_XP\setup.exe. Follow the provided instructions and reboot the computer, if required.
Chipset X:\OXY5315A Driver\INF
Display X:\OXY5315A Driver\VGA\WIN2KXP_32
LAN X:\OXY5315A Driver\LAN\Windows\2000_XP_2003 Server
Audio X:\OXY5315A Driver\Audio\32bit\2K_XP

Chapter 4: AMI BIOS UTILITY

This chapter provides users with detailed descriptions on how to set up a basic system configuration through the AMIBIOS8 BIOS setup utility.

4.1 Starting

To enter the setup screens, perform the following steps:

- Turn on the computer and press the key immediately.
- After the key is pressed, the main BIOS setup menu displays. Other setup screens can be accessed from the main BIOS setup menu, such as the Chipset and Power menus.

4.2 Navigation Keys

The BIOS setup/utility uses a key-based navigation system called hot keys. Most of the BIOS setup utility hot keys can be used at any time during the setup navigation process.

Some of the hot keys are <F1>, <F10>, <Enter>, <ESC>, and <Arrow> keys.



Some of the navigation keys may differ from one screen to another.

Left/Right	The Left and Right <Arrow> keys moves the cursor to select a menu.
Up/Down	The Up and Down <Arrow> keys moves the cursor to select a setup screen or sub-screen.
+– Plus/Minus	The Plus and Minus <Arrow> keys changes the field value of a particular setup setting.
Tab	The <Tab> key selects the setup fields.
F1	The <F1> key displays the General Help screen.
F10	The <F10> key saves any changes made and exits the BIOS setup utility.
Esc	The <Esc> key discards any changes made and exits the BIOS setup utility.
Enter	The <Enter> key displays a sub-screen or changes a selected or highlighted option in each menu.

4.3 Main Menu

The Main menu is the screen that first displays when BIOS Setup is entered, unless an error has occurred.

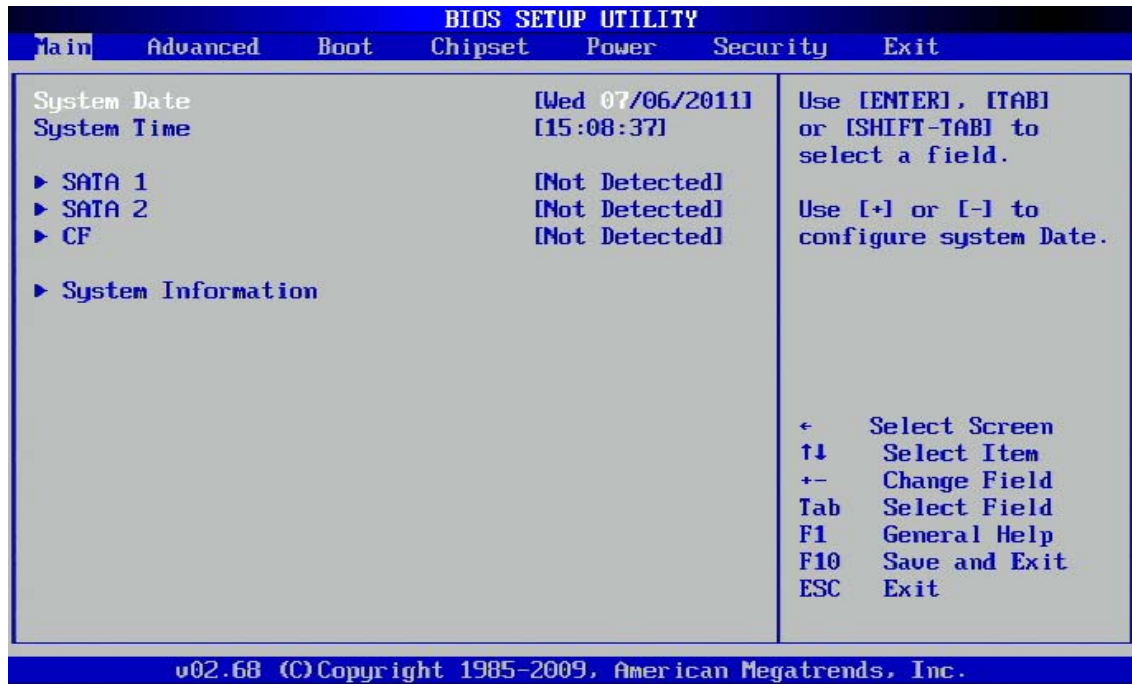

You could setup these items on the Main menu:

- System Time: Select this option to set the system time.
- System Date: Select this option to set the system date.
- CF: Select this option to set the parameters.
- System Information: Select this option to display system information.

Use the <Arrow> keys to enter the appropriate time and date. Press the <Tab> key or the <Arrow> keys to move between fields. The date setting must be entered in MM/DD/YY format. The time setting is entered in HH:MM:SS format.

SATA 1 Setup

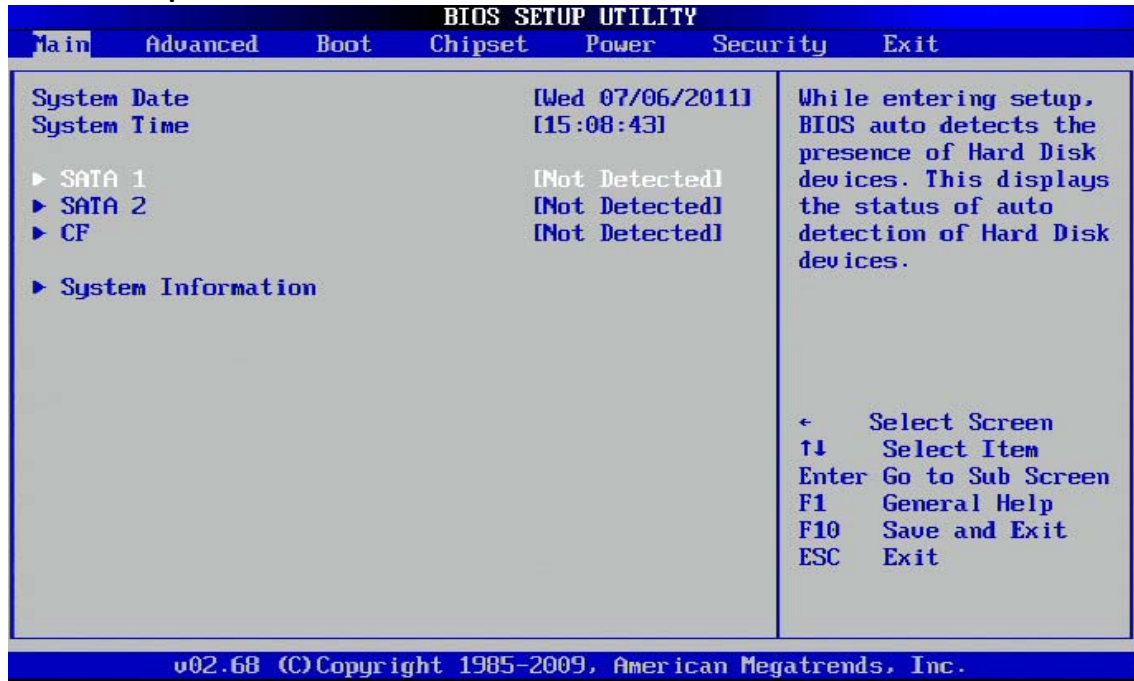

BIOS will automatically detect the presence of a SATA HDD.

SATA 1 (LBA/Large Mode)

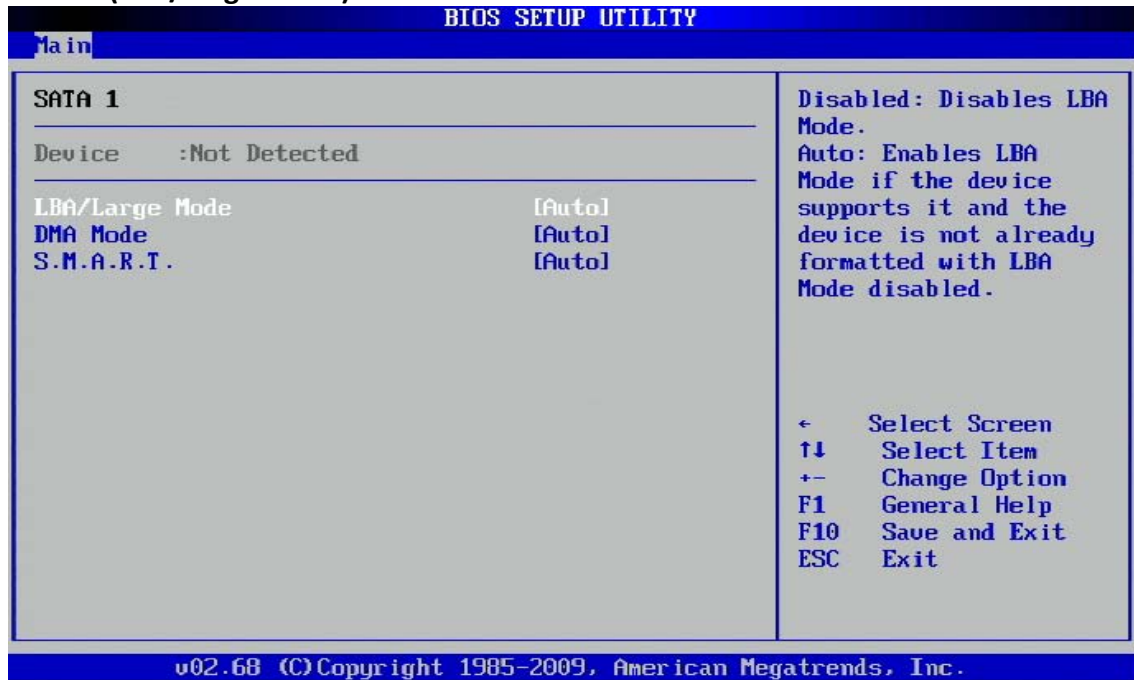

In order for LBA to work, it must be supported by the BIOS and operating system, but since it is also a new way of talking to the hard disk, the disk must support it as well. All newer hard disks do in fact support LBA, and when auto-detected by a BIOS supporting LBA, will be set up to use that mode.

A drive using LBA is not subject to the 504 MiB disk size barrier, however there has been a great deal of confusion regarding LBA and what it does. In particular, a lot of people think that it is the LBA addressing that "gets around the 504 MB barrier".

LBA from the BIOS doesn't affect newer OSs such as Linux, or NT/2000, because these OSs bypass the BIOS services and make their own direct LBA calls.

(The default BIOS setting for LBA/Large mode is Auto)

SATA 1 (DMA Mode)

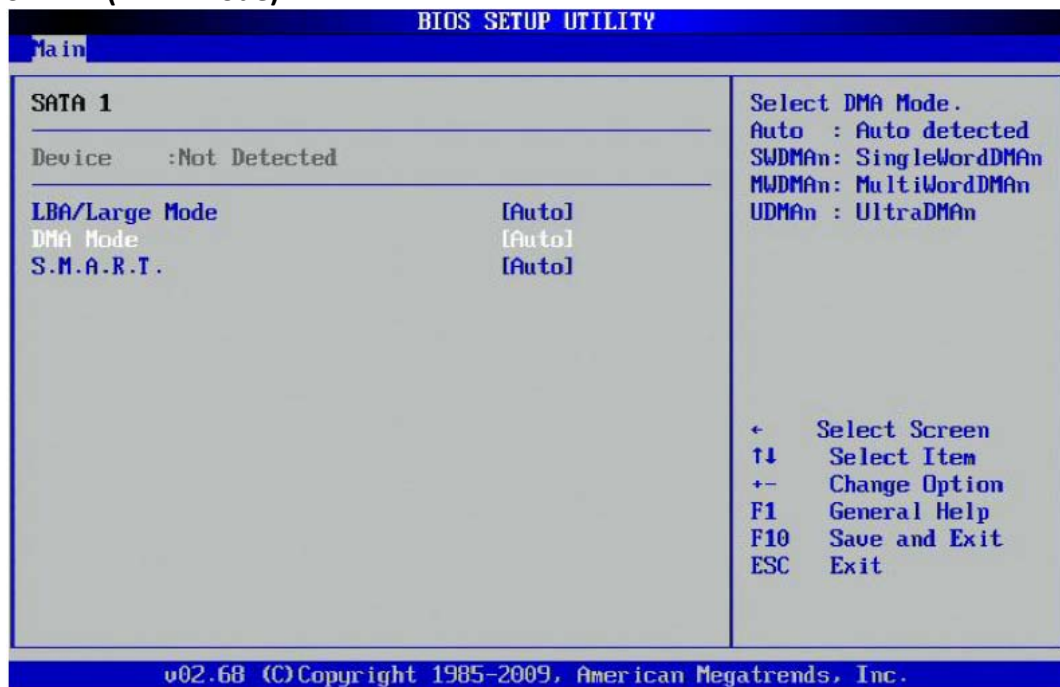

(The default BIOS setting for DMA mode is Auto)

SATA 2 Setup

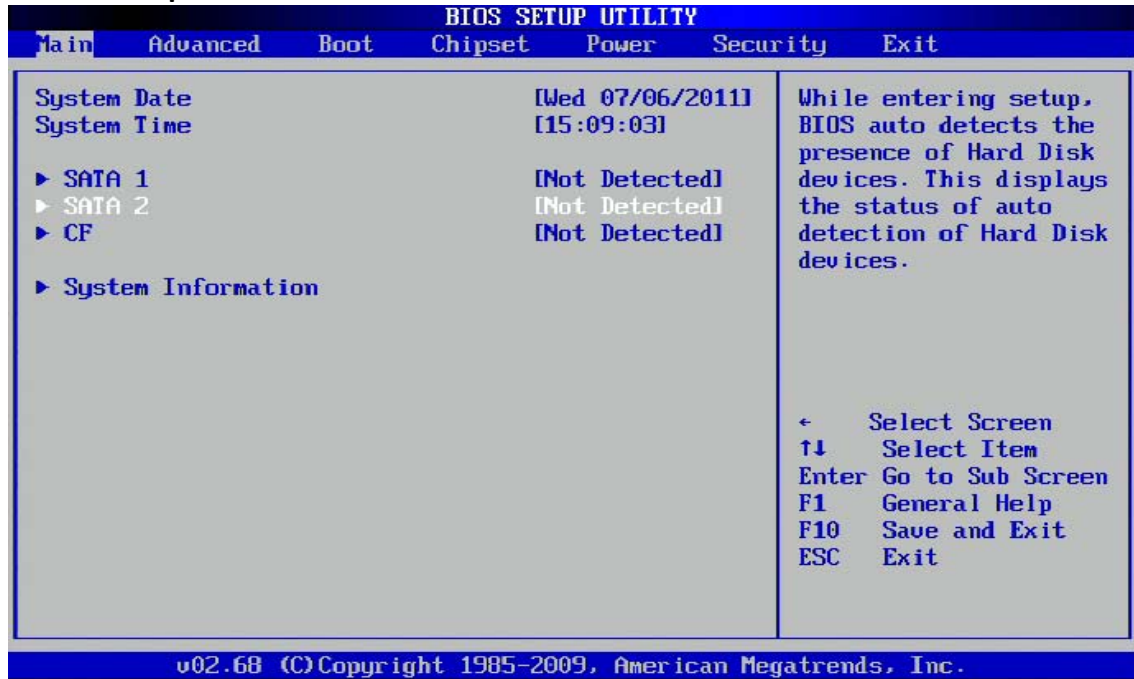

BIOS will automatically detect the presence of a SATA HDD

SATA 2 (LBA/Large Mode)



(The default BIOS setting for LBA/Large Mode is Auto)

SATA 2 (LBA/Large Mode)

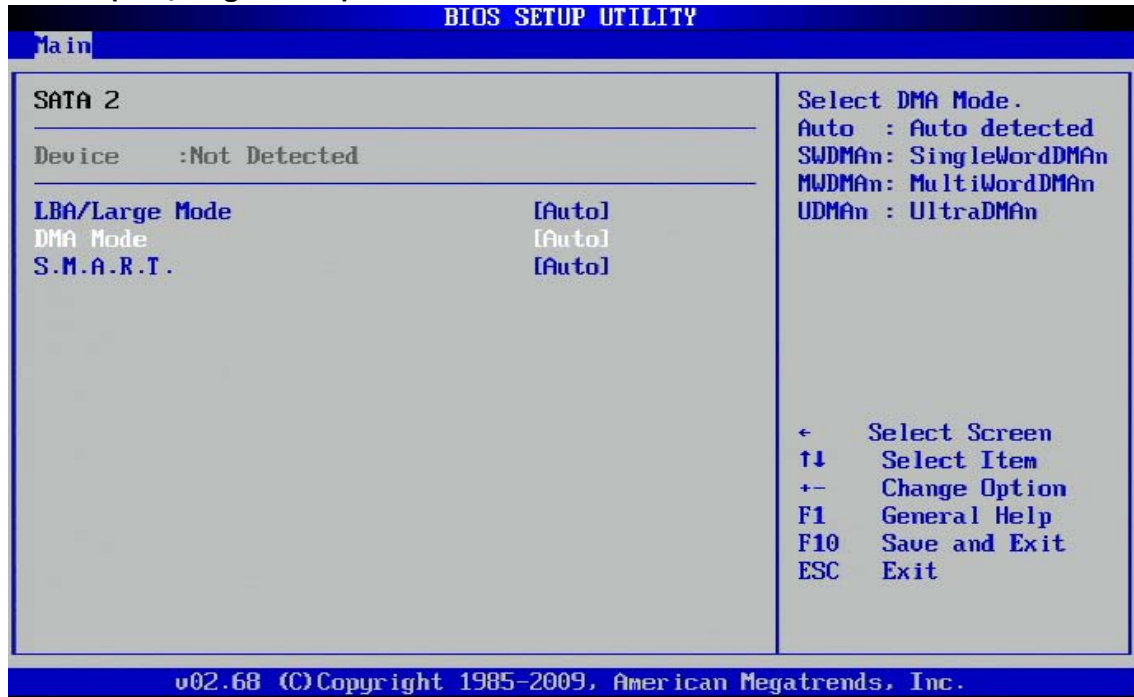

(The default BIOS setting for DMA mode is Auto)

S.M.A.R.T for SATA 2

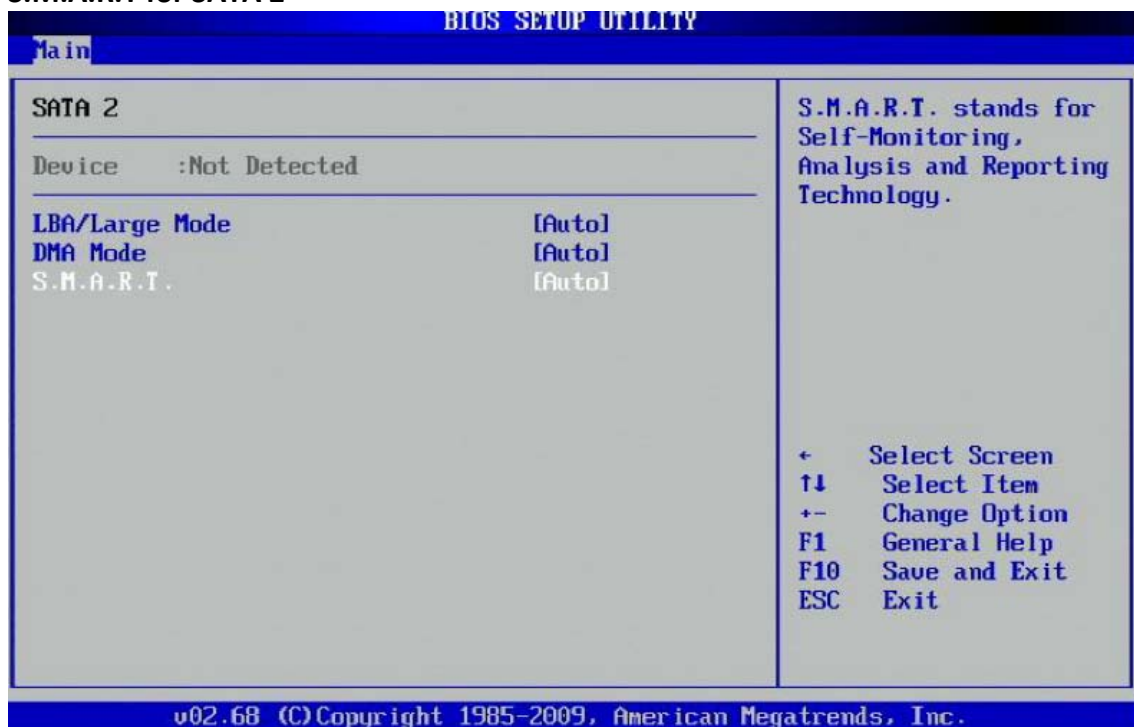

(The default BIOS setting for S.M.A.R.T is Auto)

CF Setup

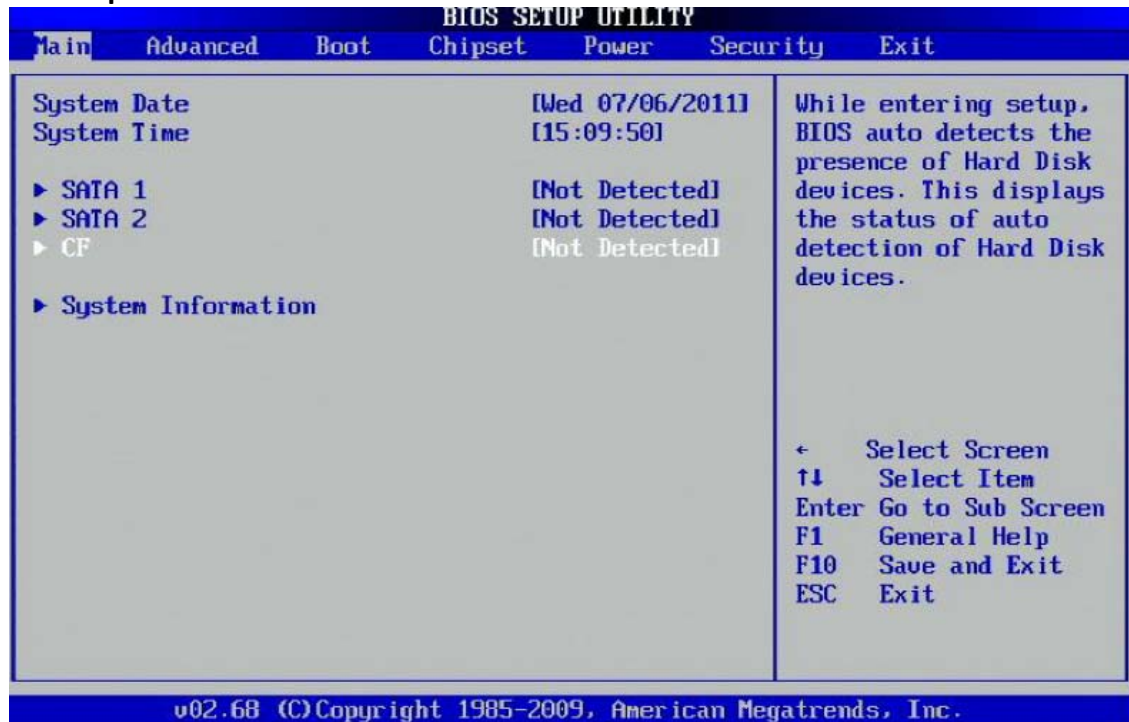

BIOS will automatically detect the presence of a CF card

CF setup (LBA/Large Mode)



(The default BIOS setting for LBA/Large mode is Auto)

CF (DMA Mode)

DMA (Direct memory access) mode is a high performance mode for transferring data to and from devices, The burner devices can function in either DMA or PIO modes. DMA mode allows the processor to transfer large pieces of data with very little software overhead - therefore requiring low CPU utilization. In this mode, high speed burning can be performed in background with other programs running. PIO mode requires CPU processing for every few bytes sent to the device, so that CPU utilization becomes very high when trying to burn at high speeds.

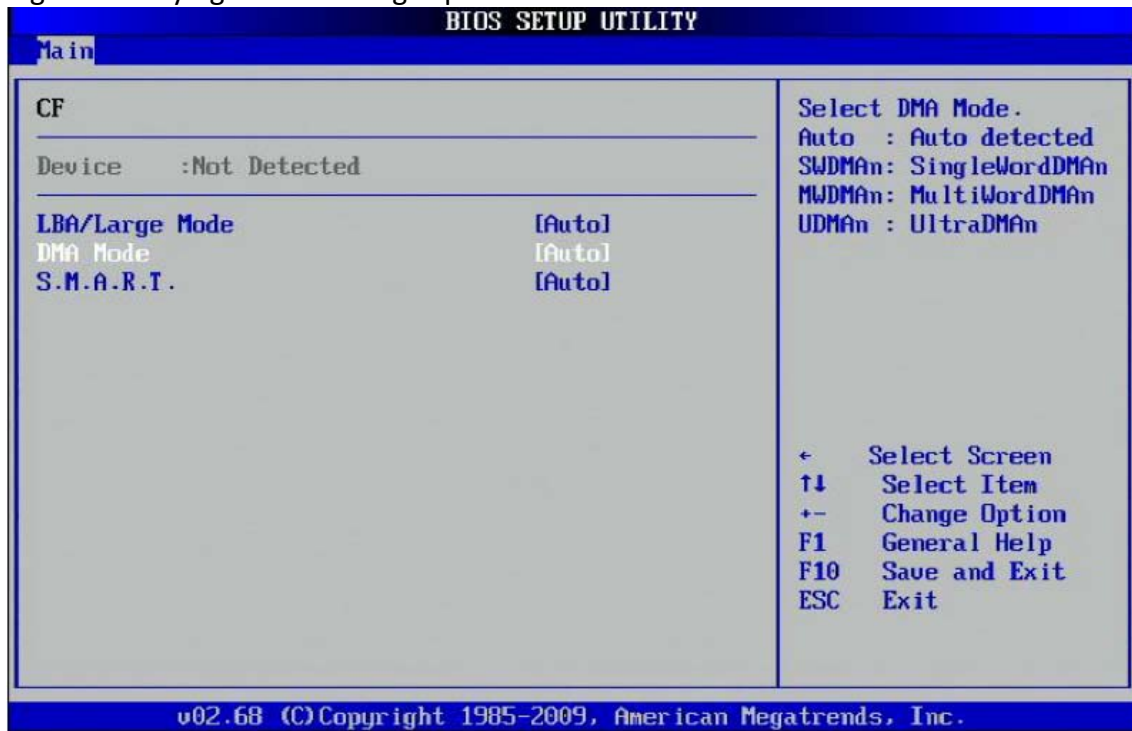

S.M.A.R.T for CF

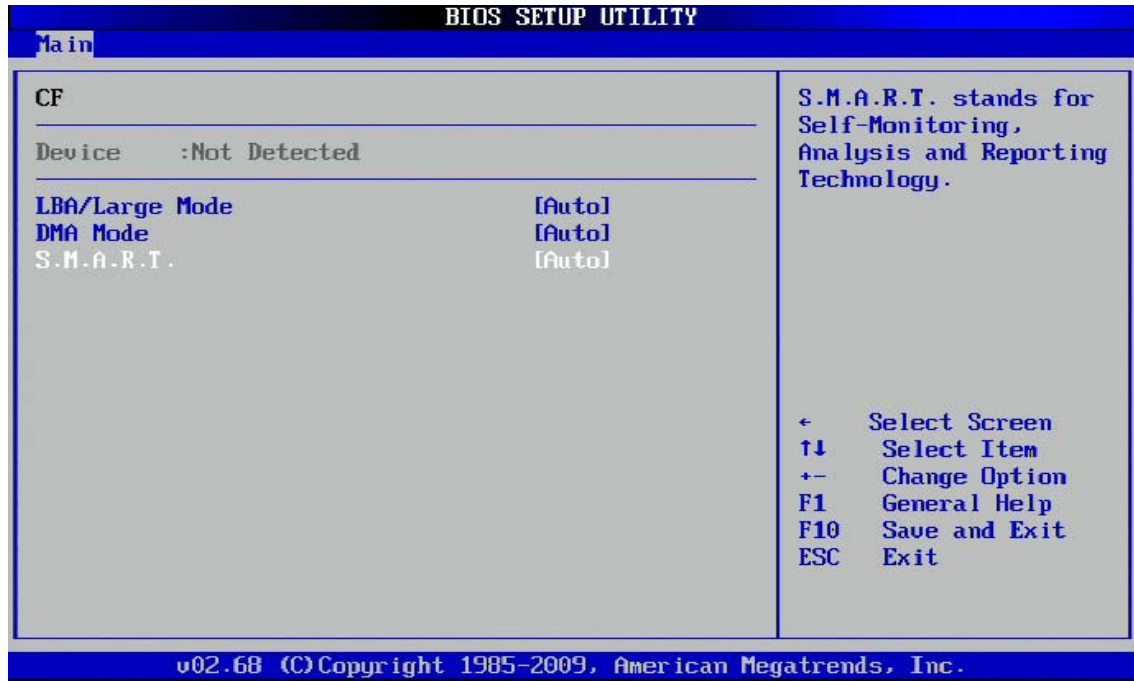

S.M.A.R.T. (Self-Monitoring, Analysis and Reporting Technology; sometimes written as SMART) is a monitoring system for computer hard disk drives to detect and report on various indicators of reliability, in the hope of anticipating failures.

When a failure is anticipated by S.M.A.R.T., the user may choose to replace the drive to avoid unexpected outage and data loss. The manufacturer may be able to use the S.M.A.R.T. data to discover where faults lie and prevent them from recurring in future drive designs

System Information

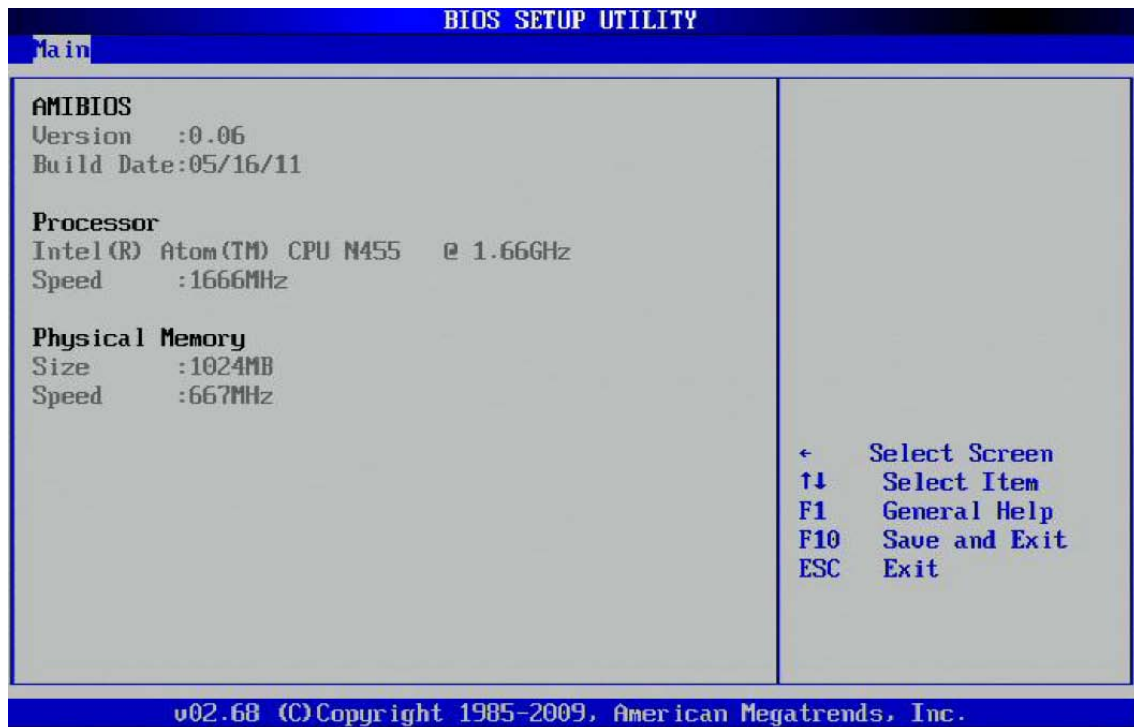
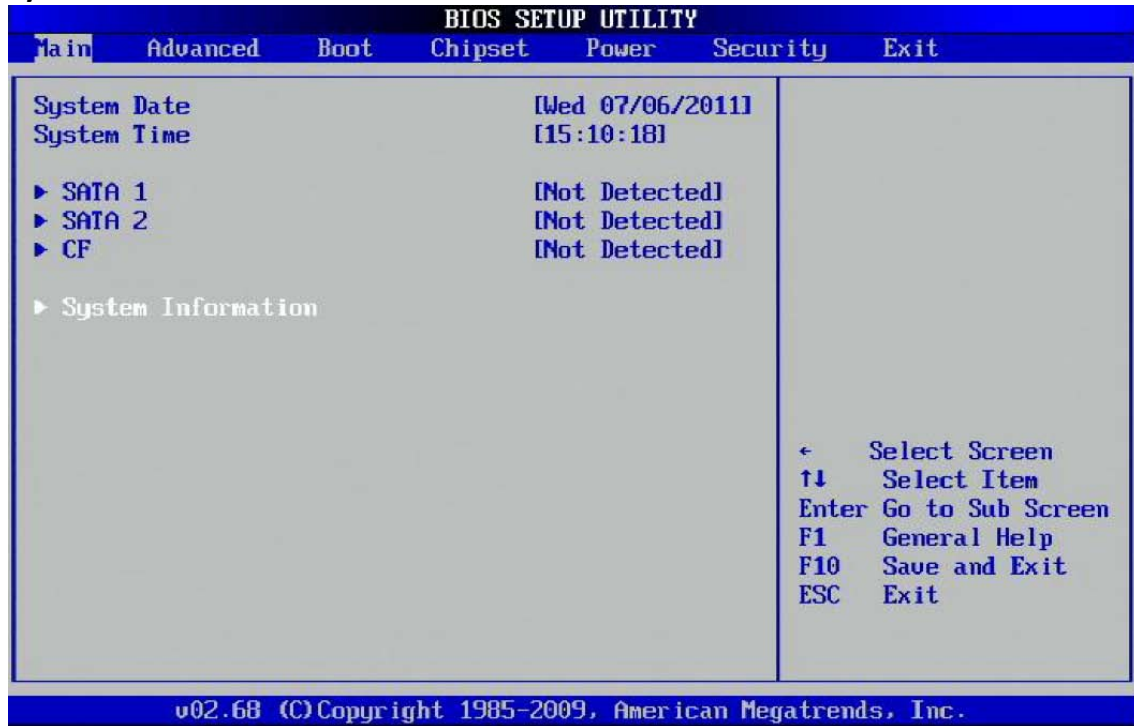

You can review the system information in the BIOS System Information menu.

- OXY5315A contains an embedded Intel N455 CPU.

4.4 Advanced Menu

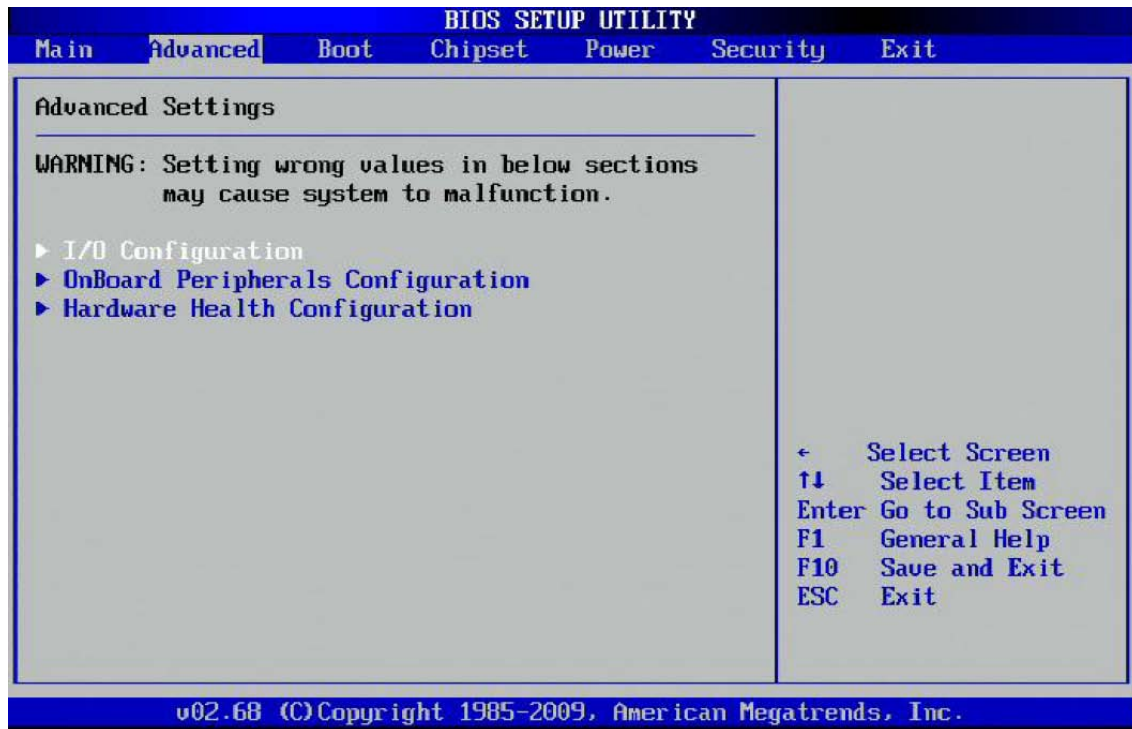

Onboard I/O Configuration

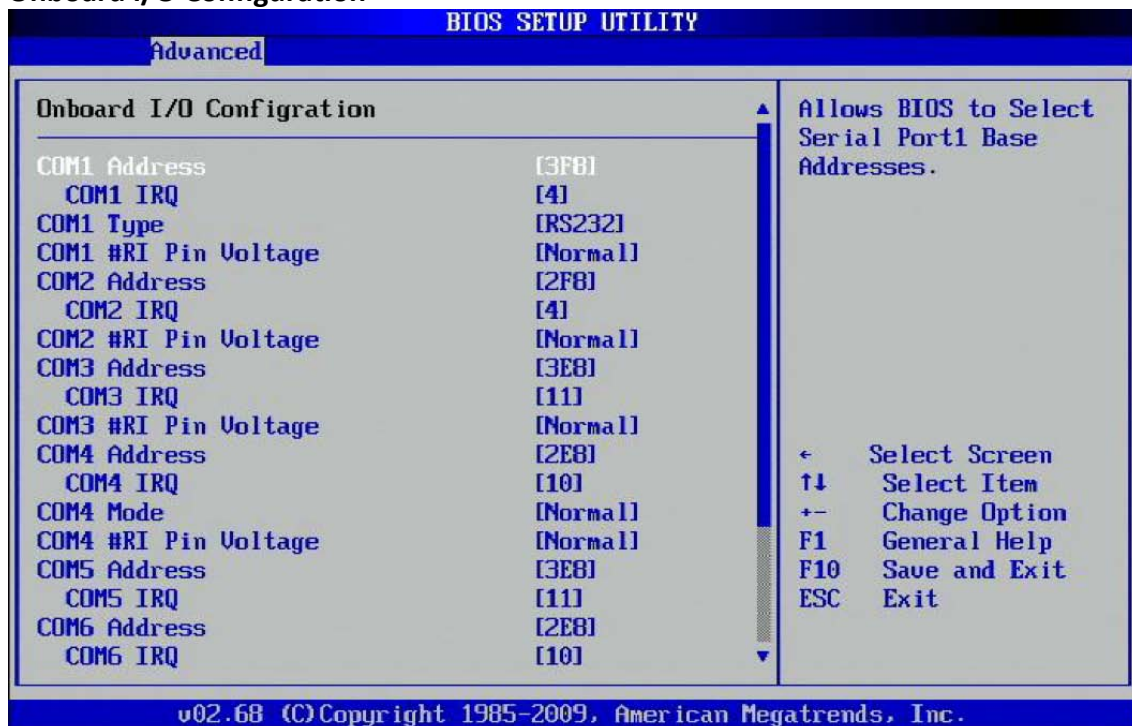

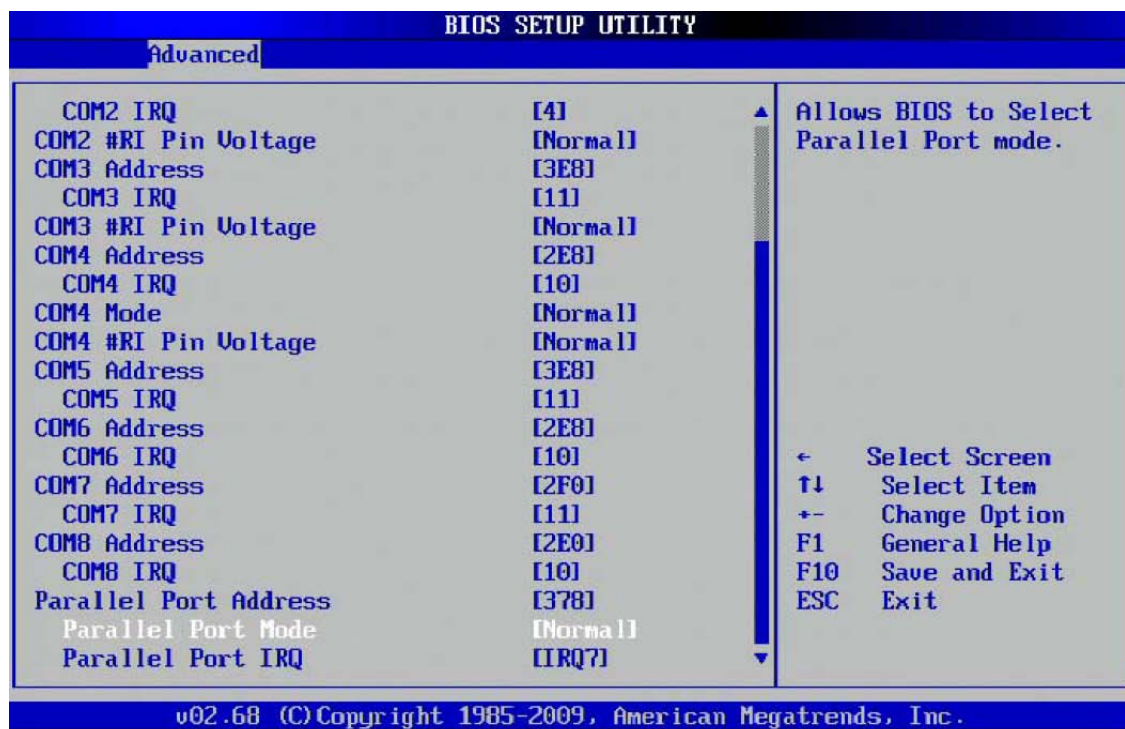

You could setup the IRQ and IRQ address for the OXY5315A. This line of 3.5" SBC supports 8xCOM Ports (COM1 Port belongs to D-Sub 9pin and supports RS232/422/485. COM2~COM8 belongs to the 1x10 pin wafer connector and supports RS232)

Onboard Peripherals Configuration

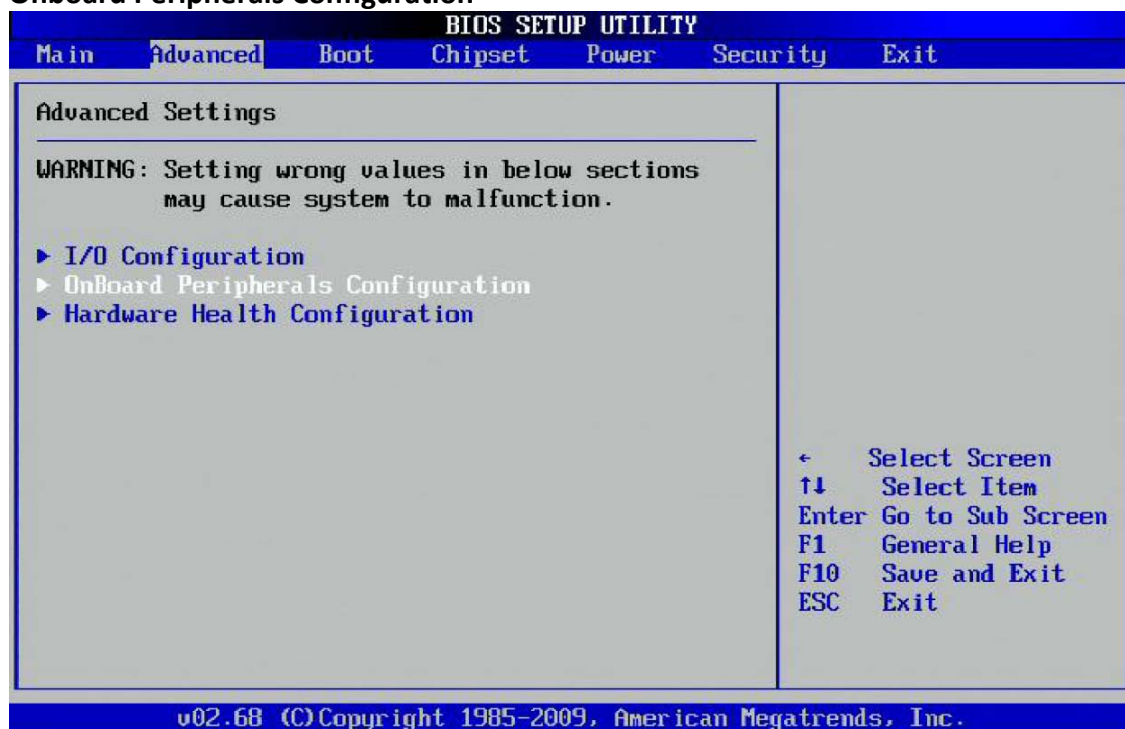

USB Function



You could enable or disable the onboard USB functions and/or USB 2.0 Controller.

USB Device Legacy Support

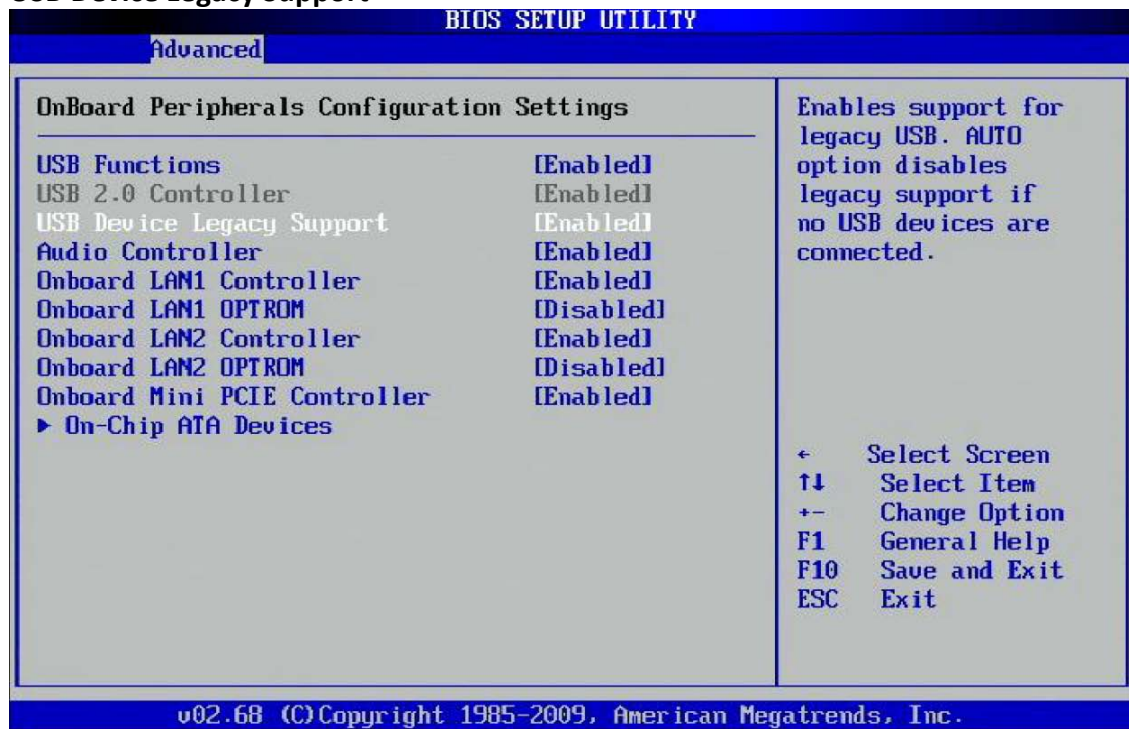

Legacy mode support is inherent to a system and is typically provided by legacy hardware interface emulation.

Legacy mode support allows devices to function in an operating environment.

(The default BIOS setting for USB Legacy support is Enabled)

Audio Controller



This setting enables or disables the onboard Audio Controller.

(The default BIOS setting for Audio Controller default is Enabled)

Onboard LAN1 Controller



This setting enables or disables the OnBoard LAN1 Controller.

Onboard LAN1 OPTROM

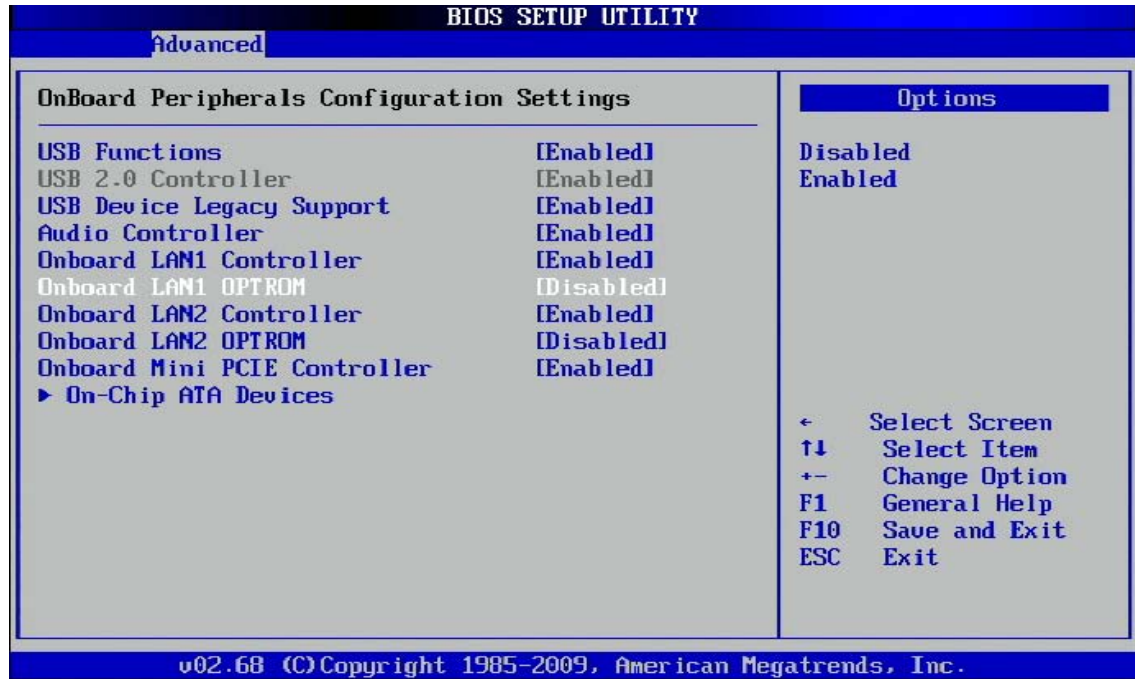

This setting enables or disables the Onboard LAN1 OPTROM setting.
 (The default BIOS setting for Onboard LAN1 OPTROM is Disabled)

Onboard LAN2 Controller



This setting enables or disables the Onboard LAN2 Controller.

Onboard LAN2 OPTROM

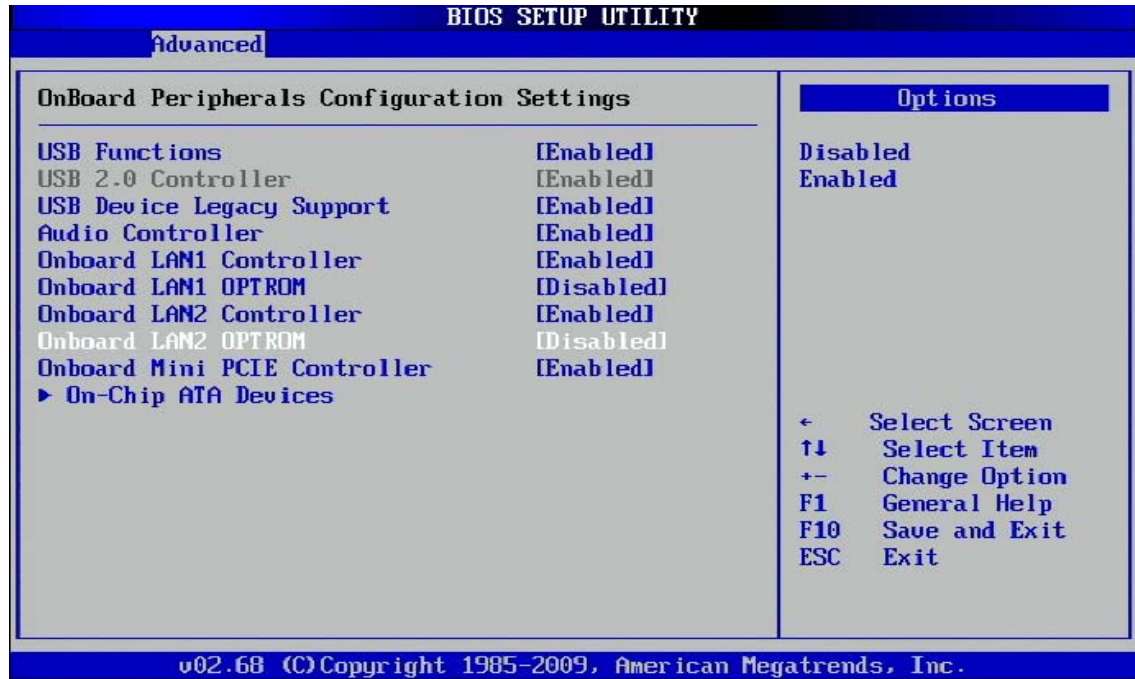

This setting enables or disables the Onboard LAN2 OPTROM.
(The default BIOS setting is Disabled)

Onboard Mini-PCIE Controller

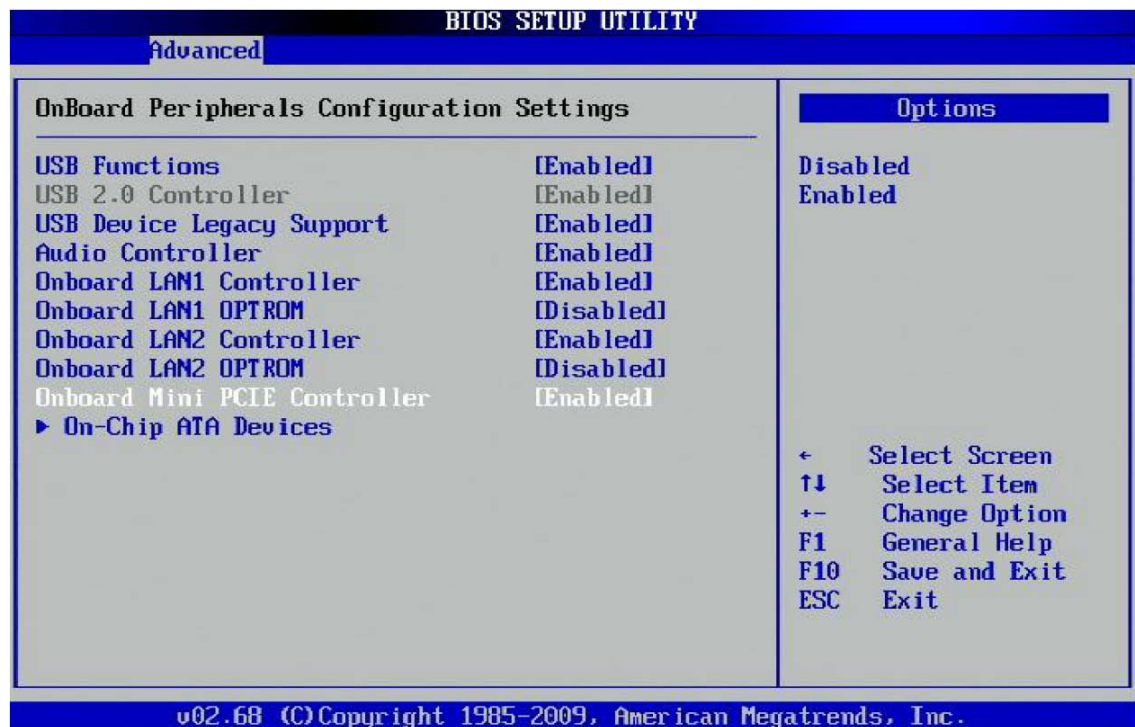

This setting enables or disables the Onboard Mini-PCIE Controller.

On-Chip ATA Devices

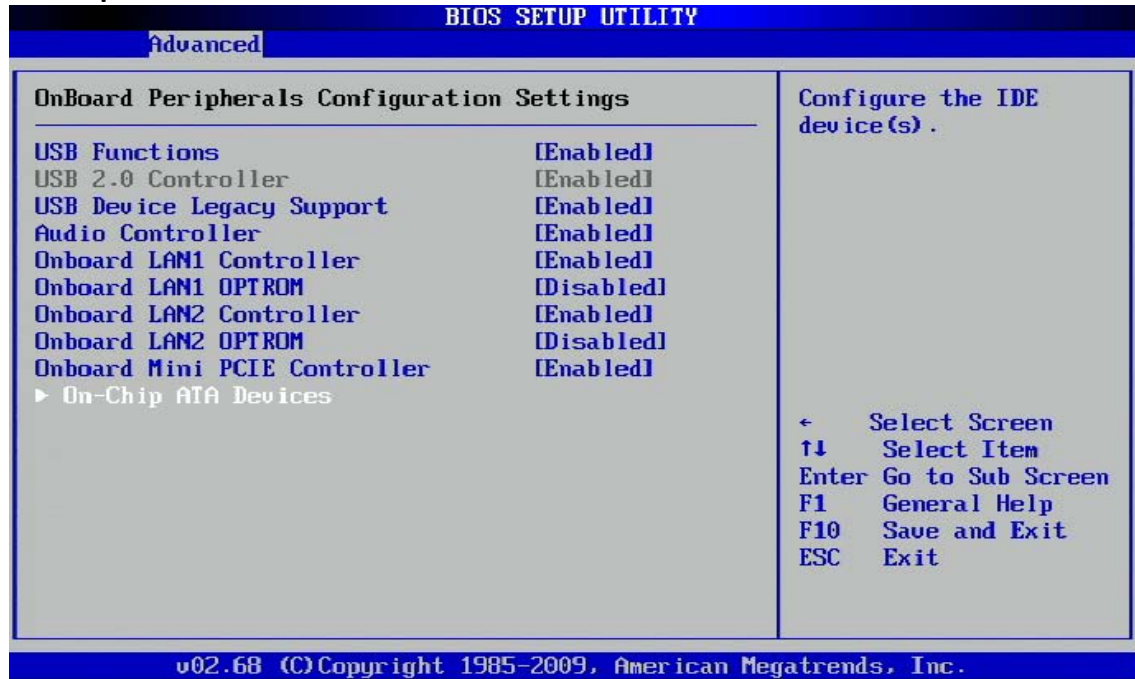

This setting contains two sub-menus. Press Enter to access the secondary menu. The secondary menu has two settings:

ATA/IDE Configuration

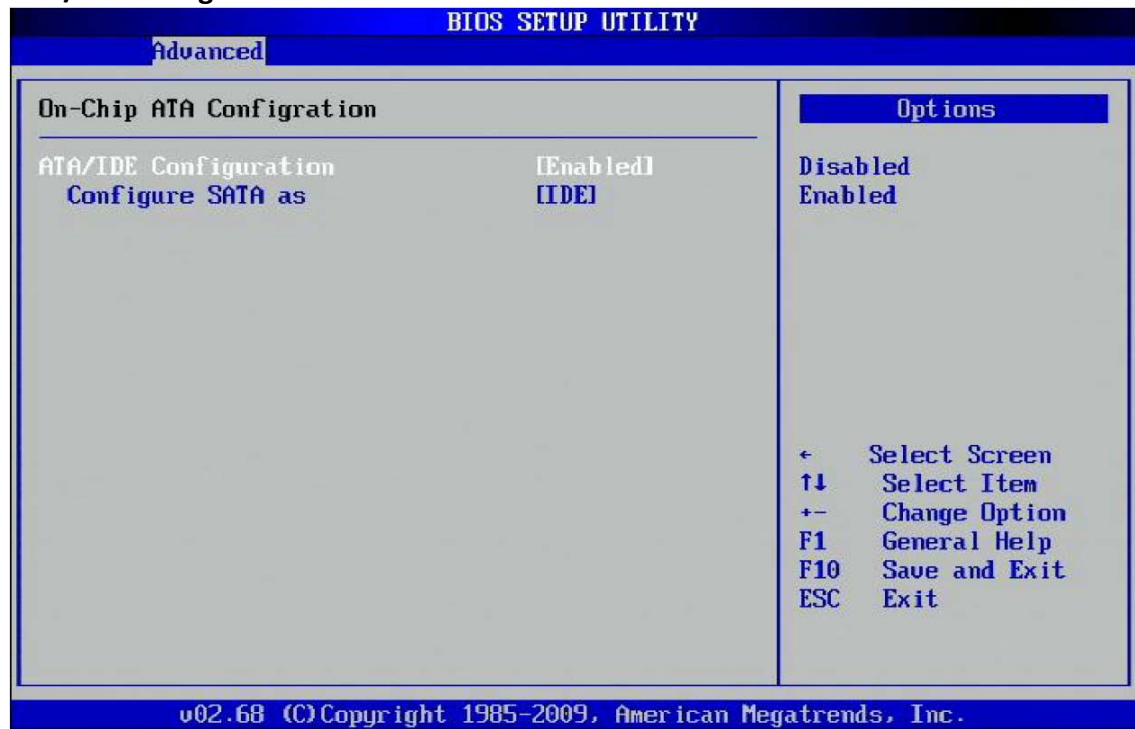

This setting enables or disables the ATA/IDE Configuration.

Configure SATA as

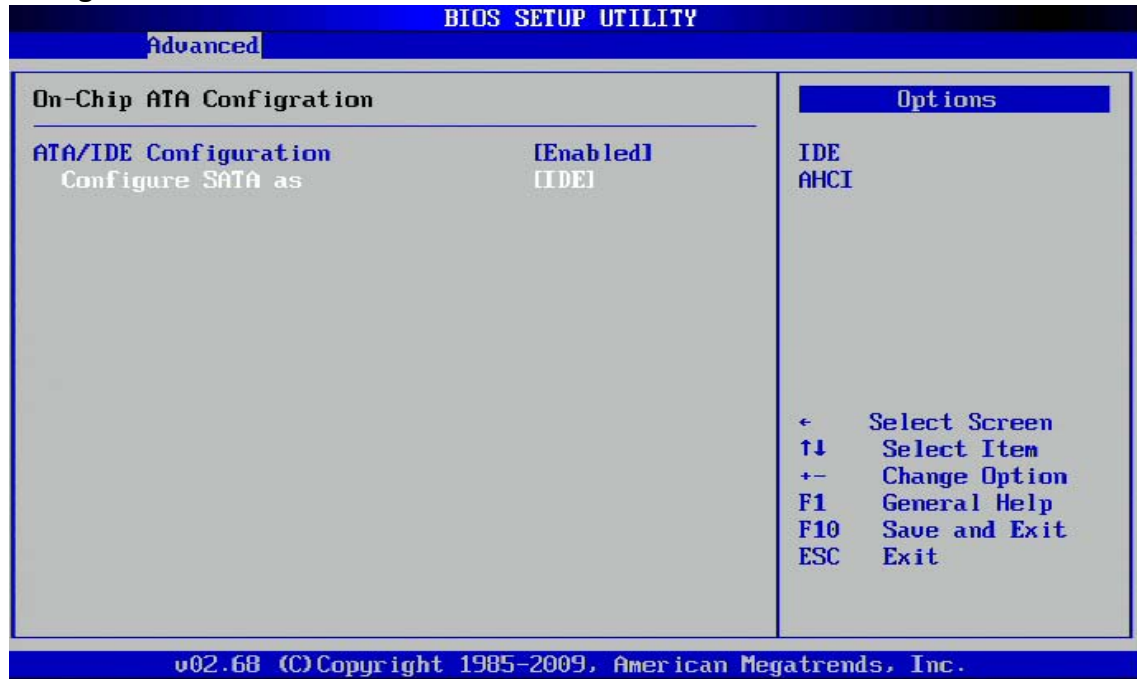

This setting allows the most important peripheral equipment. The menu options are: IDE and AHCI

*IDE: The function provides the bridge for the IDE to SATA hard disk drive function.

*AHCI: This supports a SATA 3GB connection and supports NCQ and e-SATA.

Hardware Health Configuration

The Hardware Health Configuration setting displays the system hardware details such as CPU Warning Temperature, CPU Temperature, System Temperature, CPU FAN speed, VCORE, +3.3V, +5V and +12V

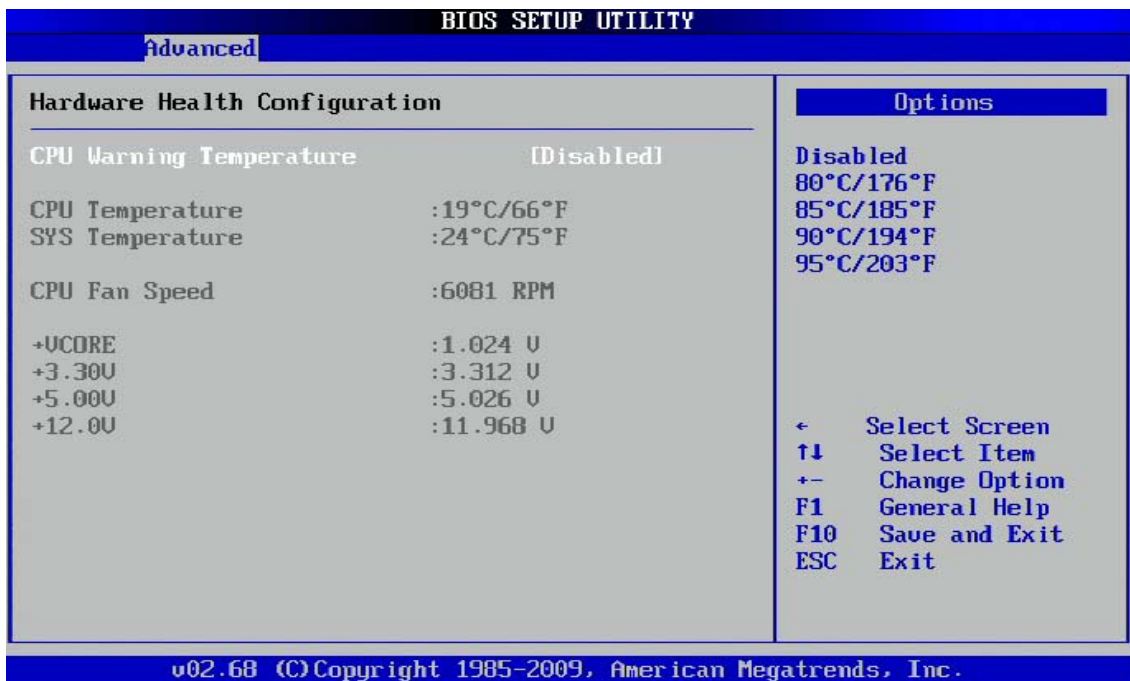

4.5 Boot Setting

The setting allows you to setup the Boot sequence for a 3.5" SBC.

Quick Boot

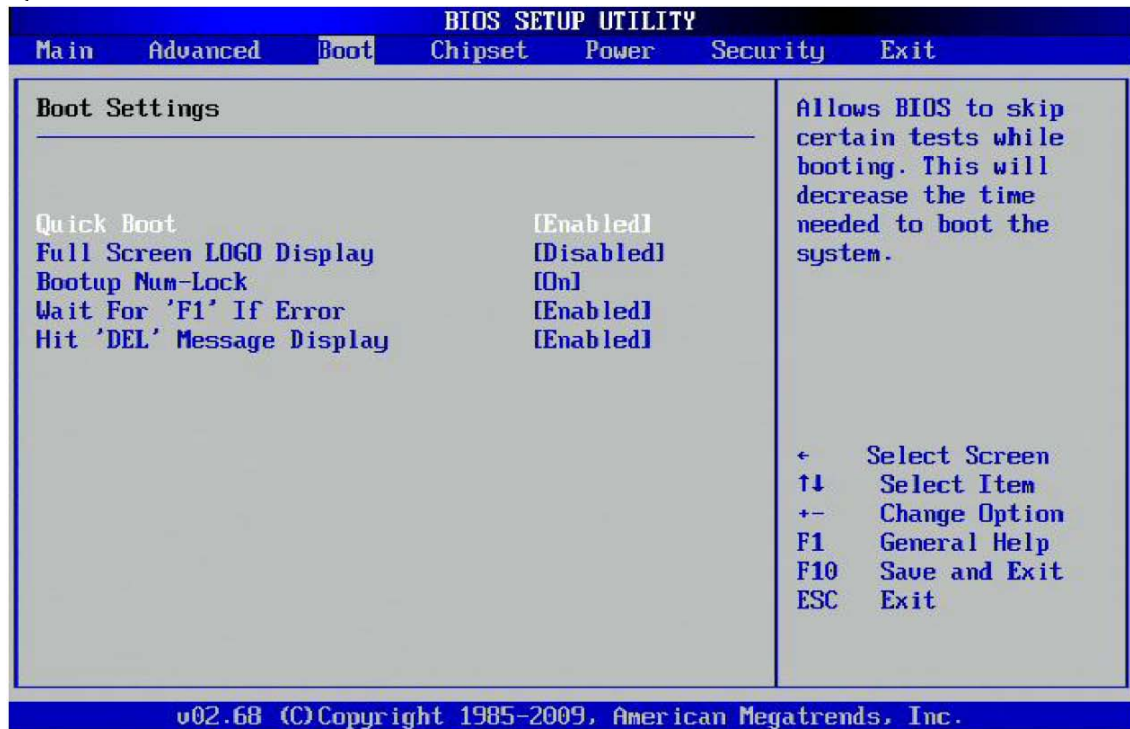

(The default BIOS setting is Enabled)

Full Screen Logo Display

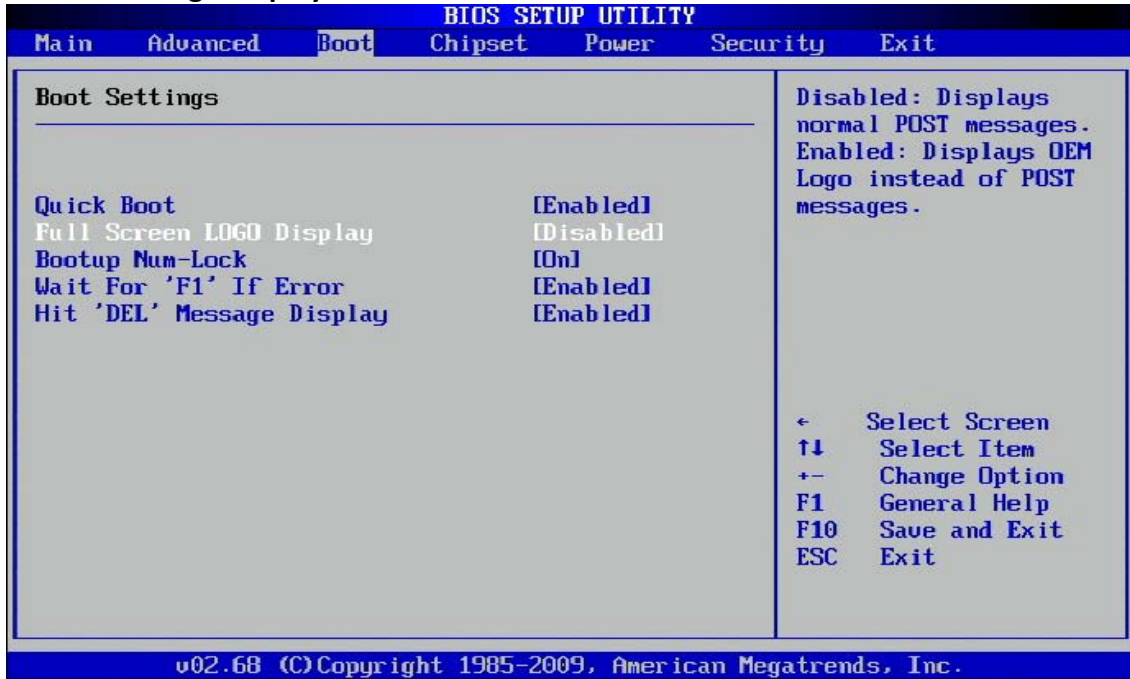

Bootup Num-lock

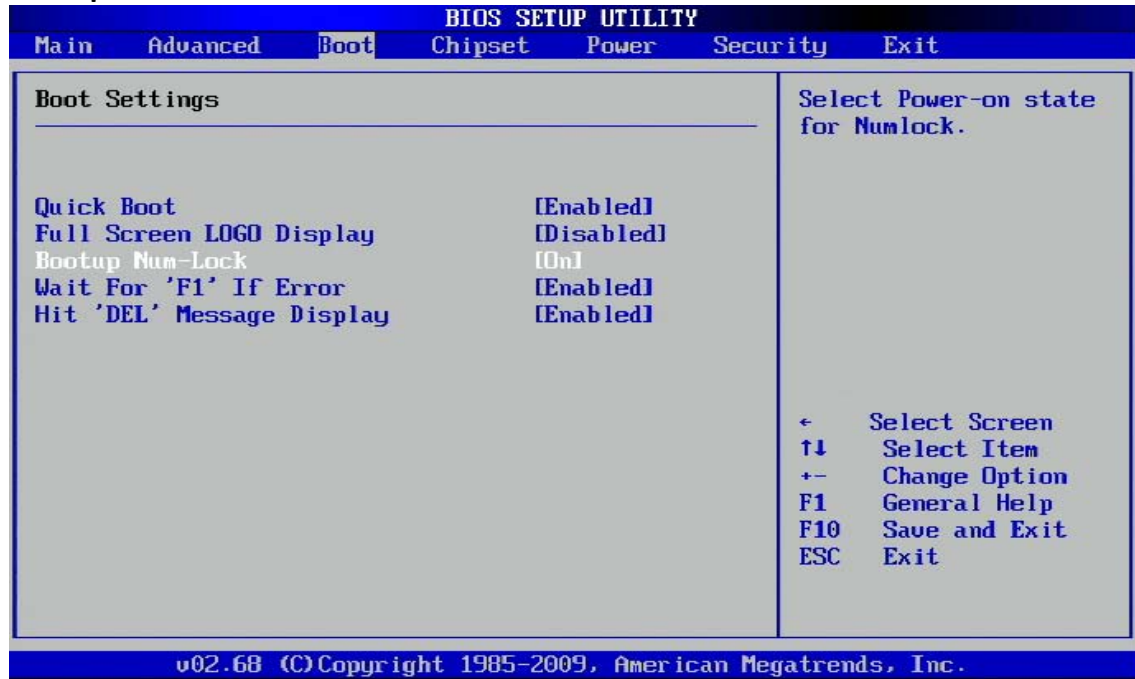

Wait For 'F1' If Error

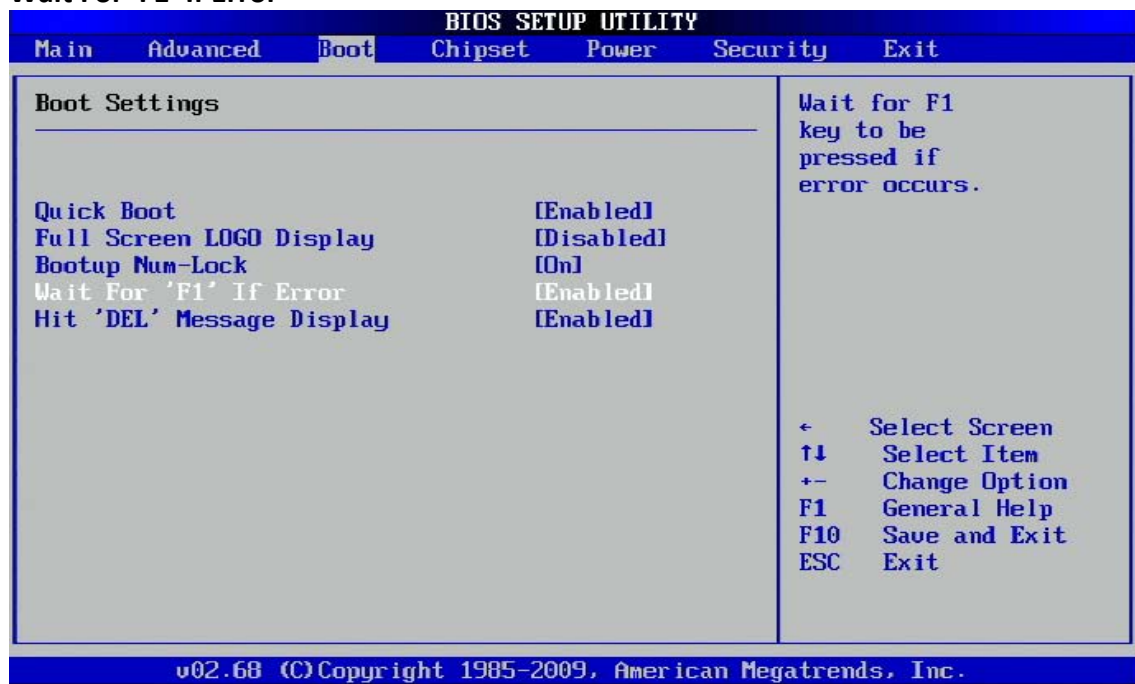

Hit 'Del' Message Display

BIOS SETUP UTILITY		
Main	Advanced	Boot
Boot Settings <hr/> Quick Boot [Enabled] Full Screen LOGO Display [Disabled] Bootup Num-Lock [On] Wait For 'F1' If Error [Enabled] Hit 'DEL' Message Display [Enabled]		Displays "Press DEL to run Setup" in POST. ← Select Screen ↑↓ Select Item +- Change Option F1 General Help F10 Save and Exit ESC Exit
v02.68 (C) Copyright 1985-2009, American Megatrends, Inc.		

4.6 Chipset Setting

BIOS SETUP UTILITY		
Main	Advanced	Chipset
Chipset Settings <hr/> Initiate Graphic Adapter [IGD] Internal Graphics Mode Select [Enabled, 8MB] Hyper Threading Technology [Enabled]		Select which graphics controller to use as the primary boot device. ← Select Screen ↑↓ Select Item +- Change Option F1 General Help F10 Save and Exit ESC Exit
▶ Video Function Configuration		
v02.68 (C) Copyright 1985-2009, American Megatrends, Inc.		

Initial Graphic Adapter

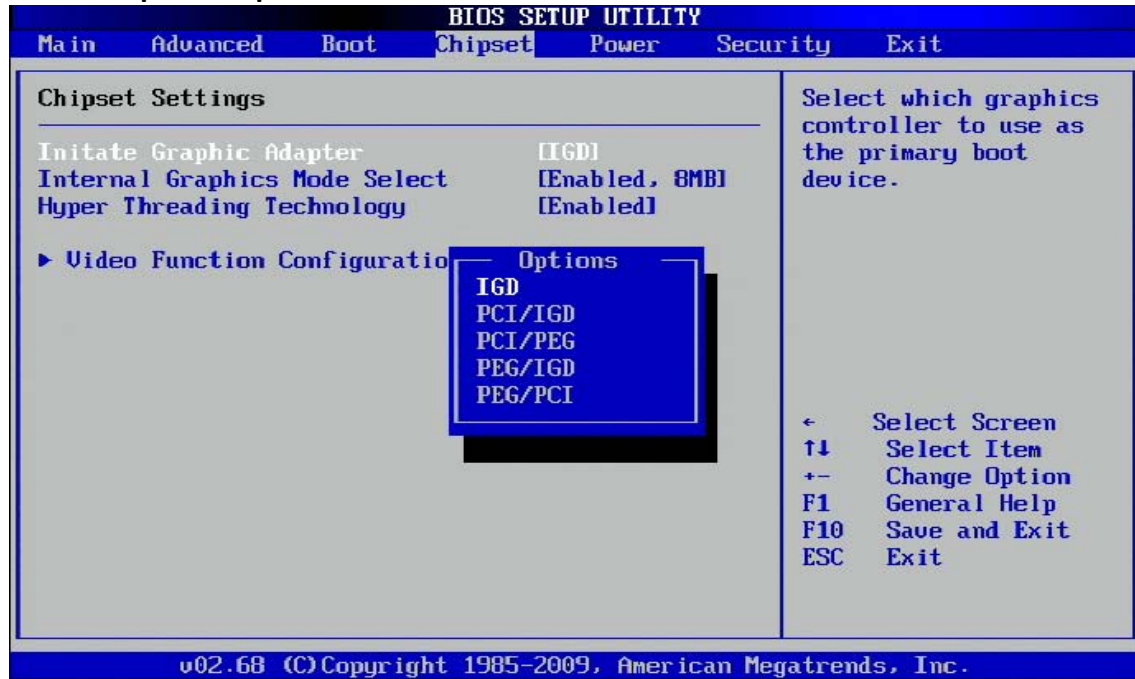

When this setting is selected, you should see options for IGD, PCI/IGD, PEG/PCI, PCI/PEG and PEG/IGD.
 IGD (Integrated Graphic Devices)
 PEG (PCI express Graphic)

Internal Graphic Mode Select

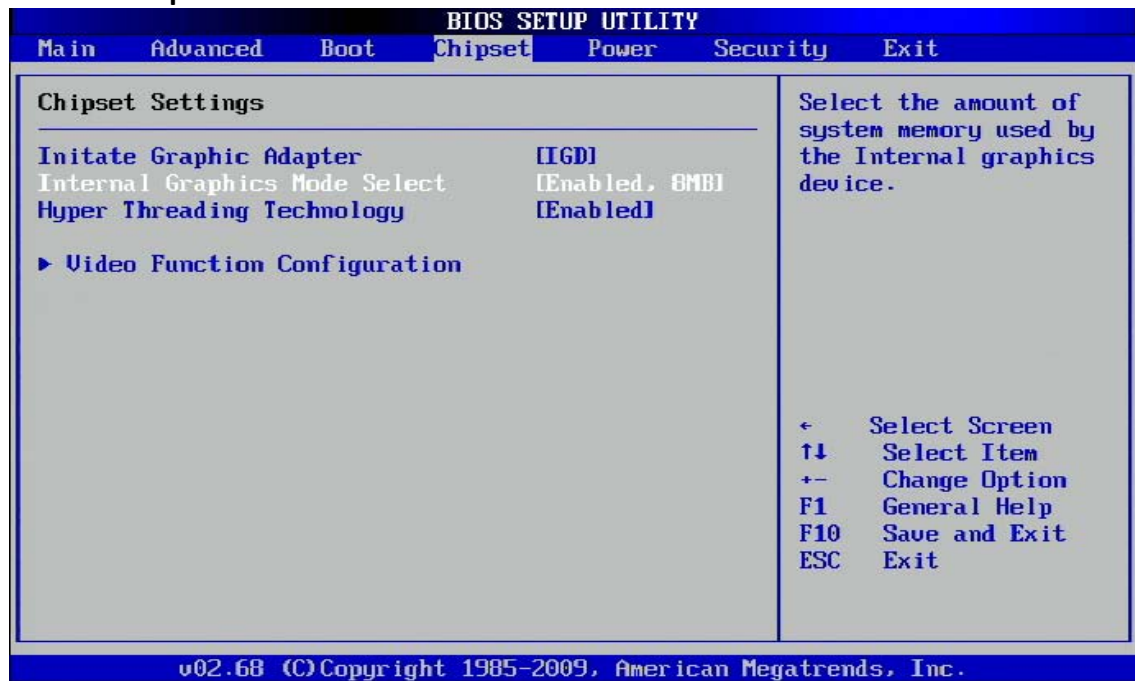

Hyper Threading Technology

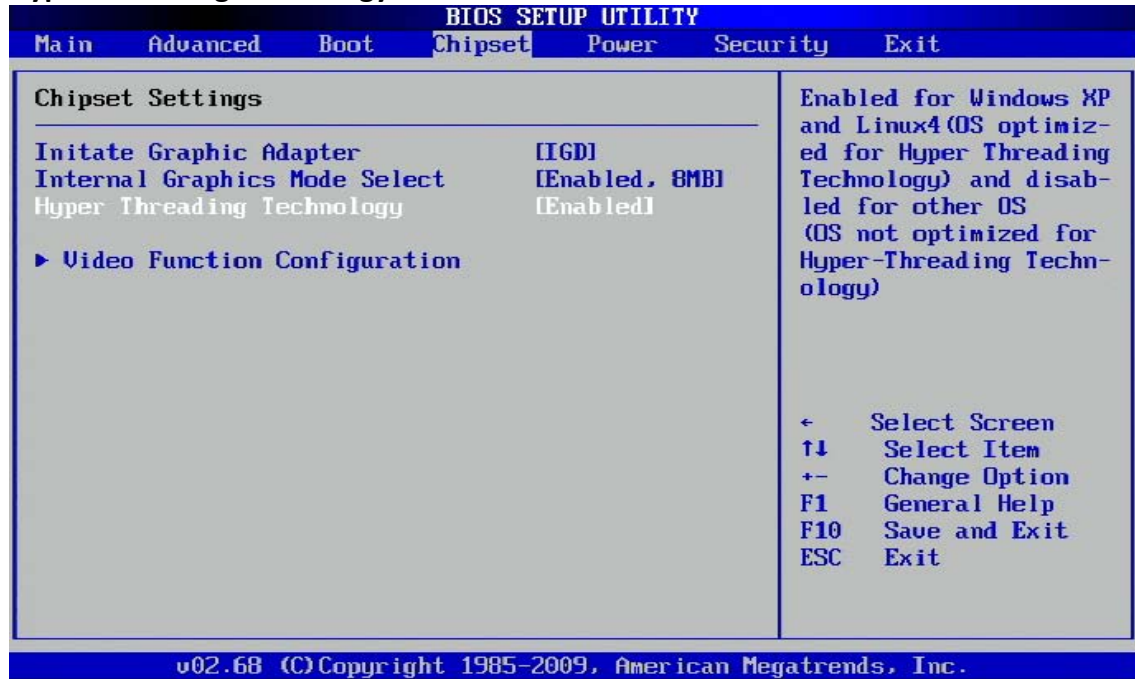

Hyper-threading technology (HTT) is Intel's term for its simultaneous multithreading implementation in some of its CPUs.

Hyper-threading is an Intel-proprietary technology used to improve performance of multiple tasks running simultaneously. For each processor core that is physically present, the operating system addresses two virtual processors, and divides the workload. Hyper-threading requires system support for multiple processors and HTT optimization. It is recommended disabling HTT when using operating systems that have not been optimized for this chip feature.

(The default BIOS setting is Enabled)

Video Function Configuration

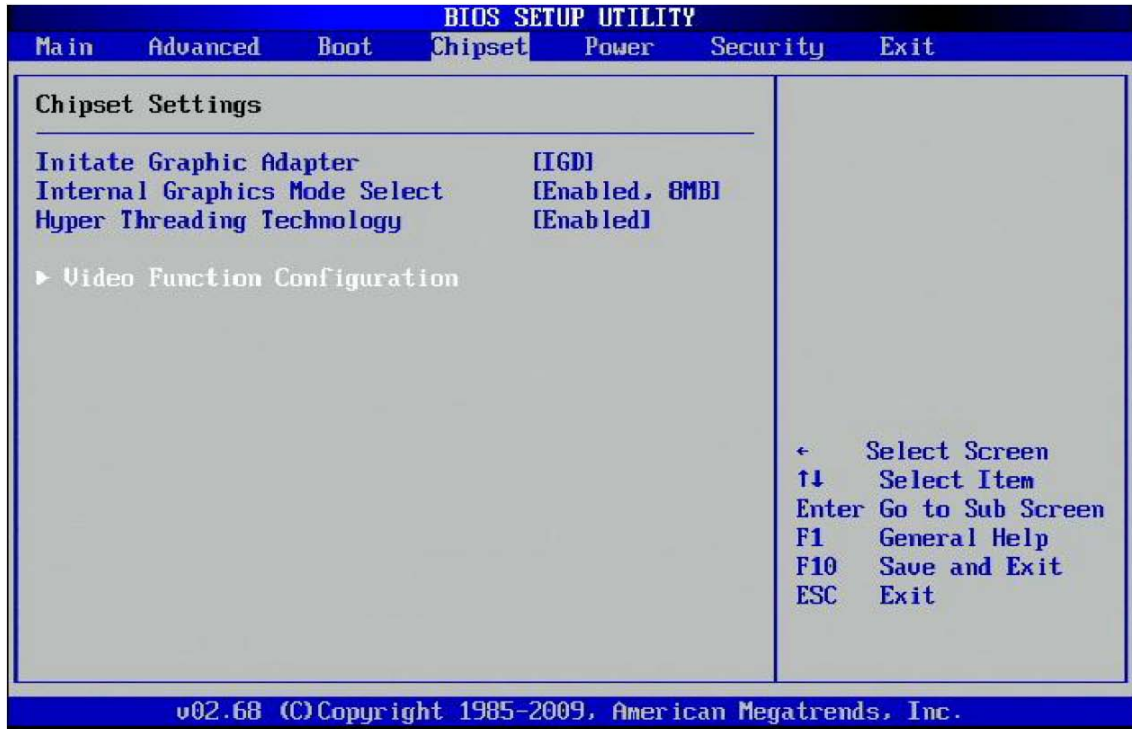

DVMT Model Select



DVMT Mode contains the following settings: Fixed Mode, DVMT Mode

DVMT/Fixed Memory

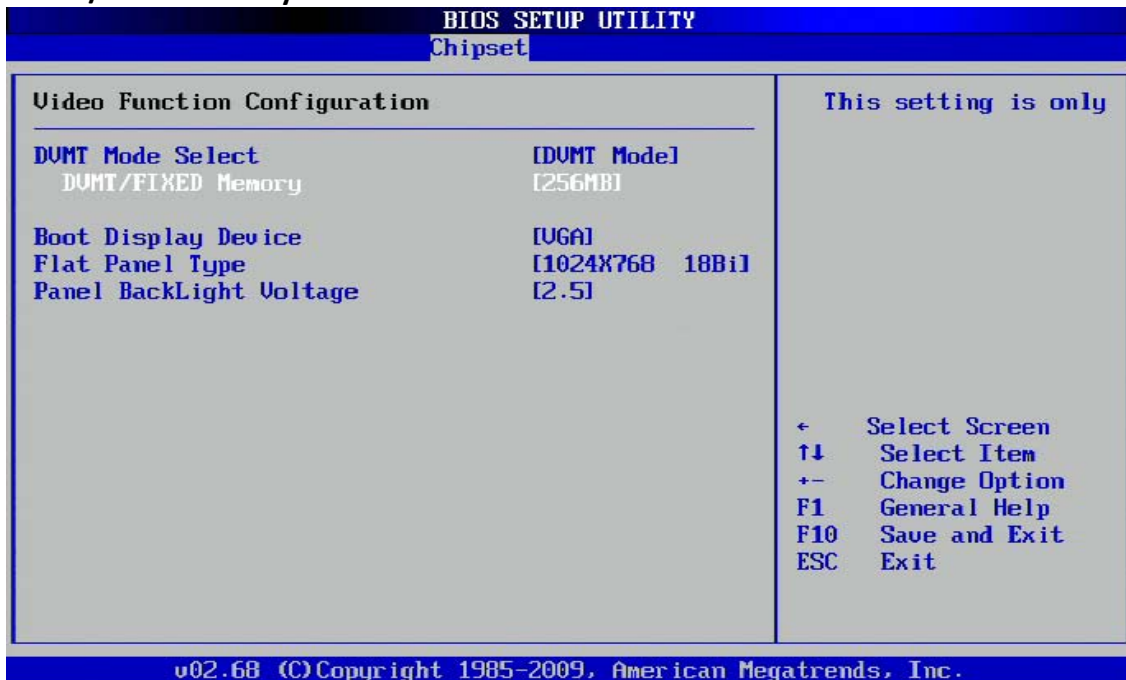

Boot Display Device

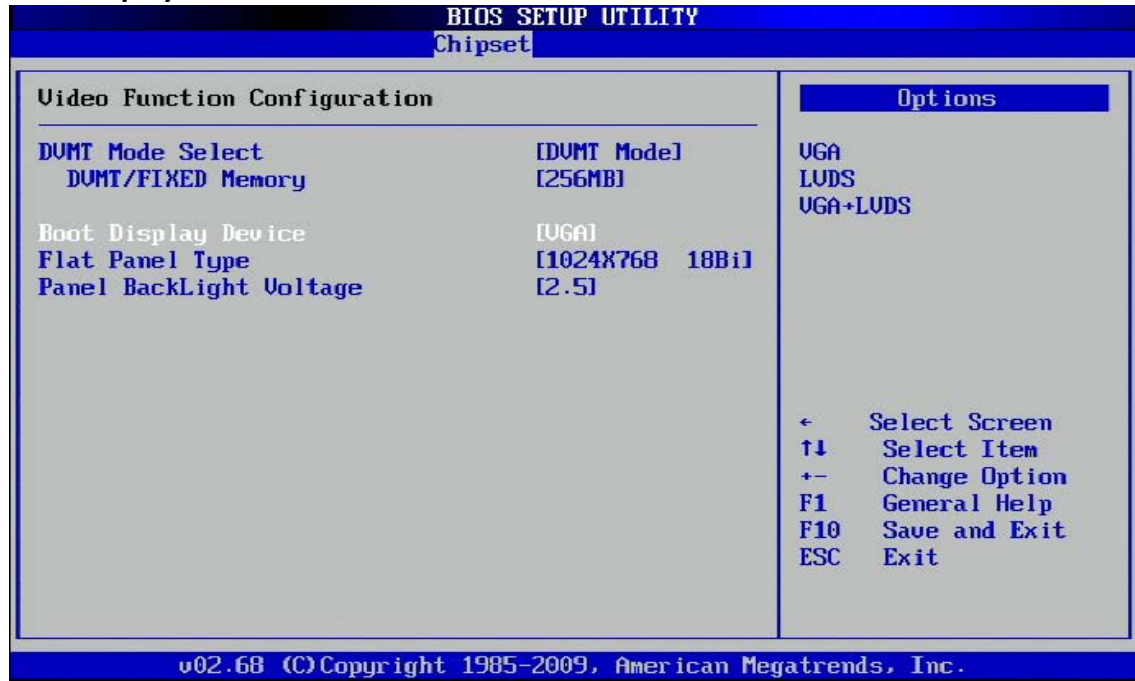

This setting allows you to setup VGA/LVDS/VGA+LVDS display mode.

Flat Panel Type



This setting allows you to setup the resolution for an onboard 18-bit LVDS.

Panel Backlight voltage

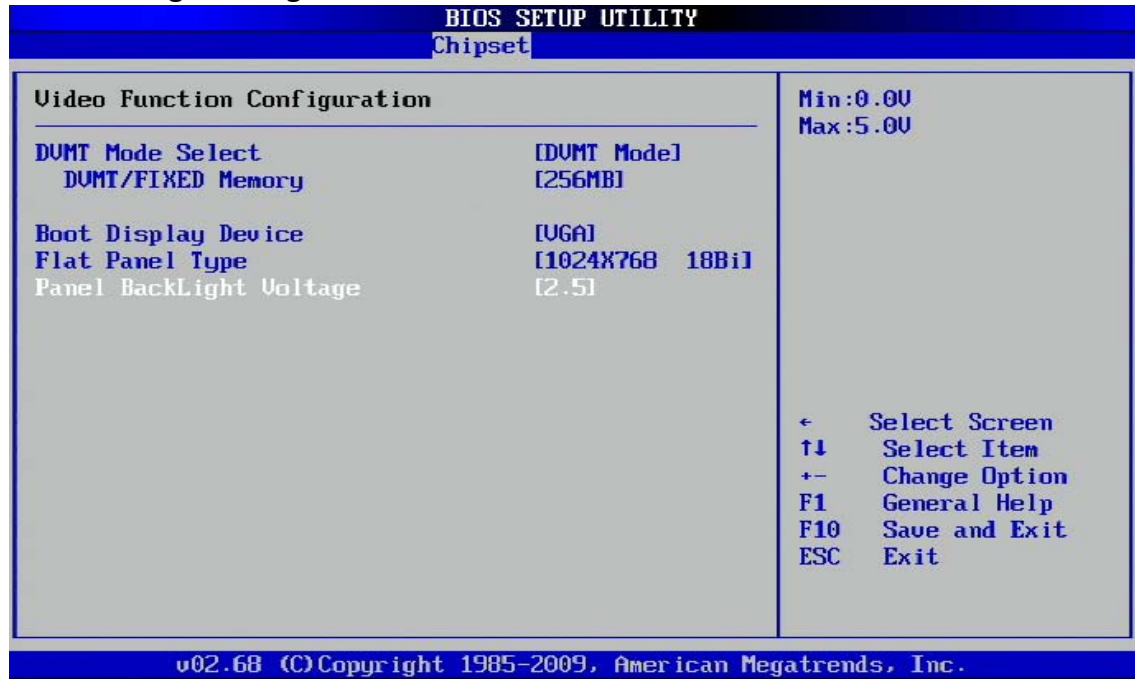

Setup the voltage for Panel

4.7 Power Management Setting

ACPI Function

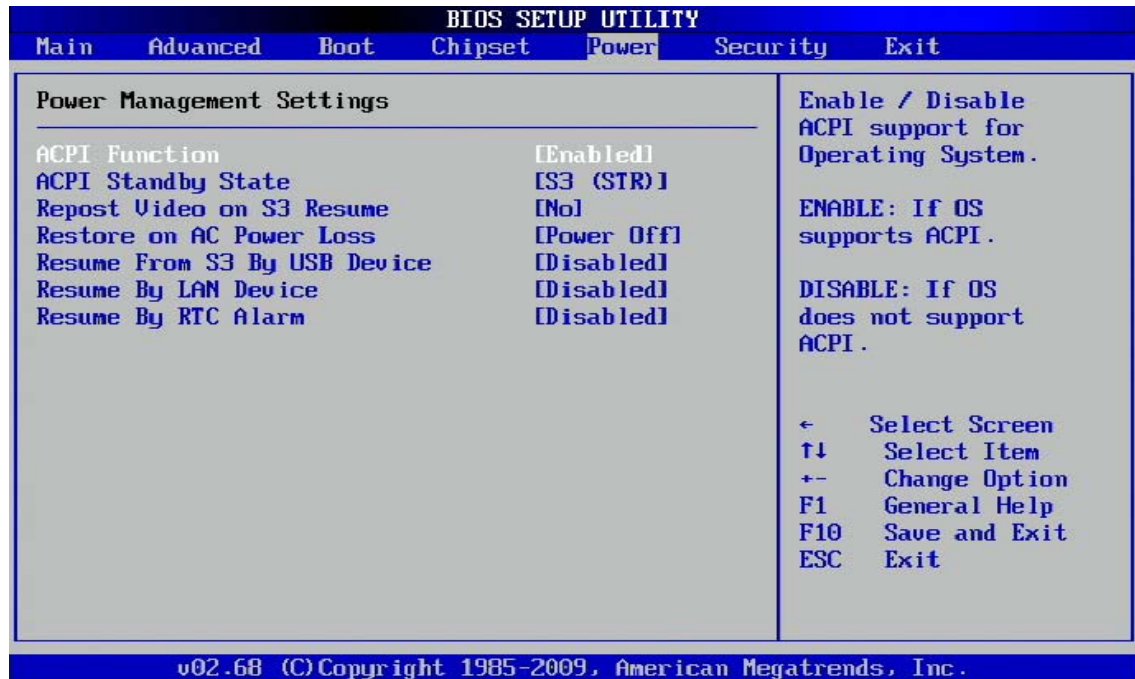

This BIOS feature is used to enable or disable the motherboard's ACPI (Advanced Configuration and Power Interface)

ACPI Standby State

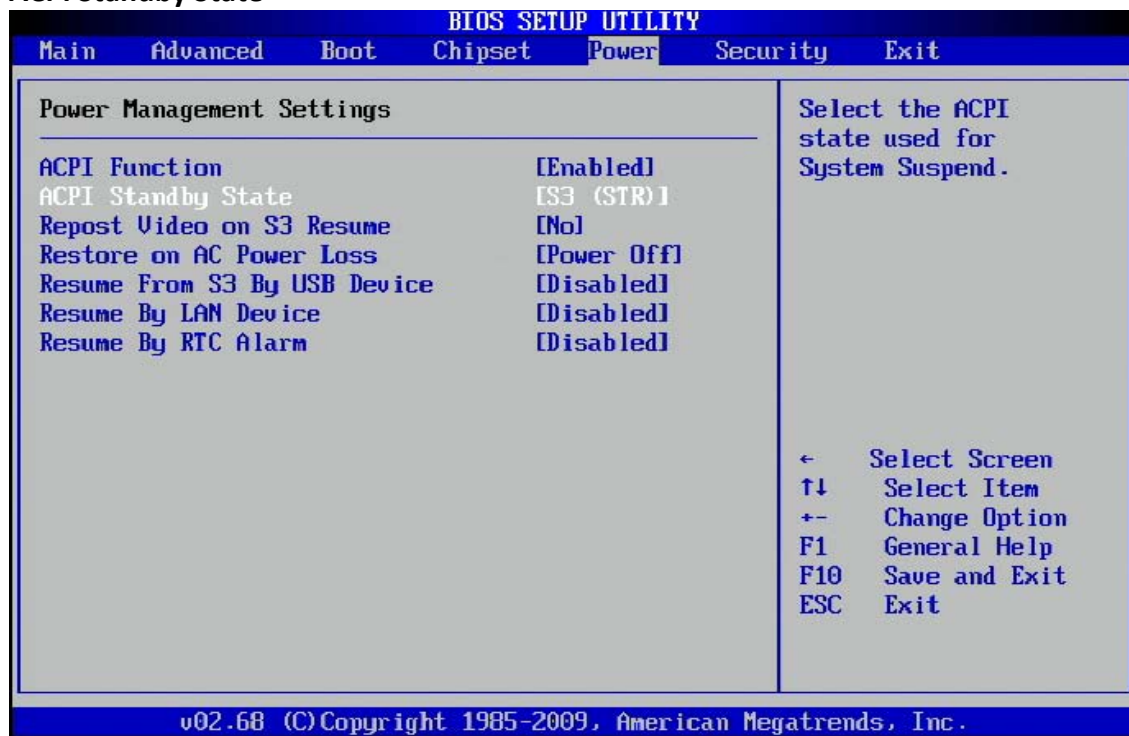

Repost Video on S3 Resume

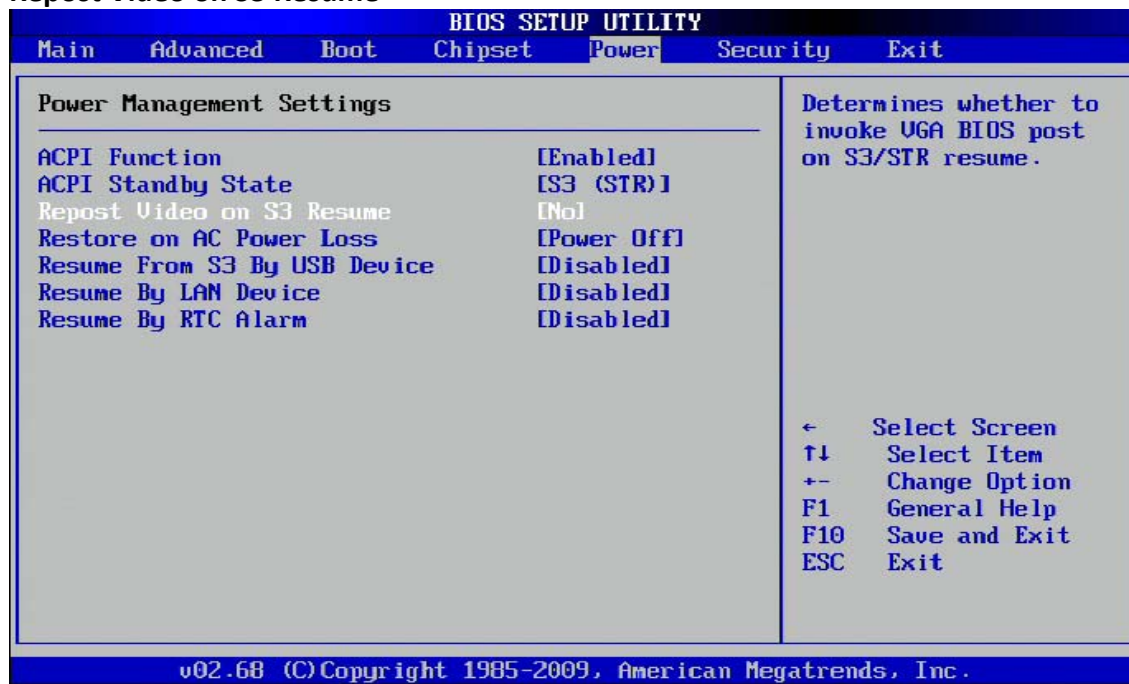

This setting controls the state of the system when it receives an ACPI standby signal (OS Independent)

S3 = Suspend to RAM - The system powers off while maintaining the active state of the system.

S1 = Power ON Standby - The system remains powered on but in a low

power state (CPU is idle but powered, usually fans and other modules are still active - hard drives spin down).

The S3 setting is preferable, but some people still have to use the S1 setting for various reasons. Either setting should not present problems to any operating system.

Restore on AC Power Loss

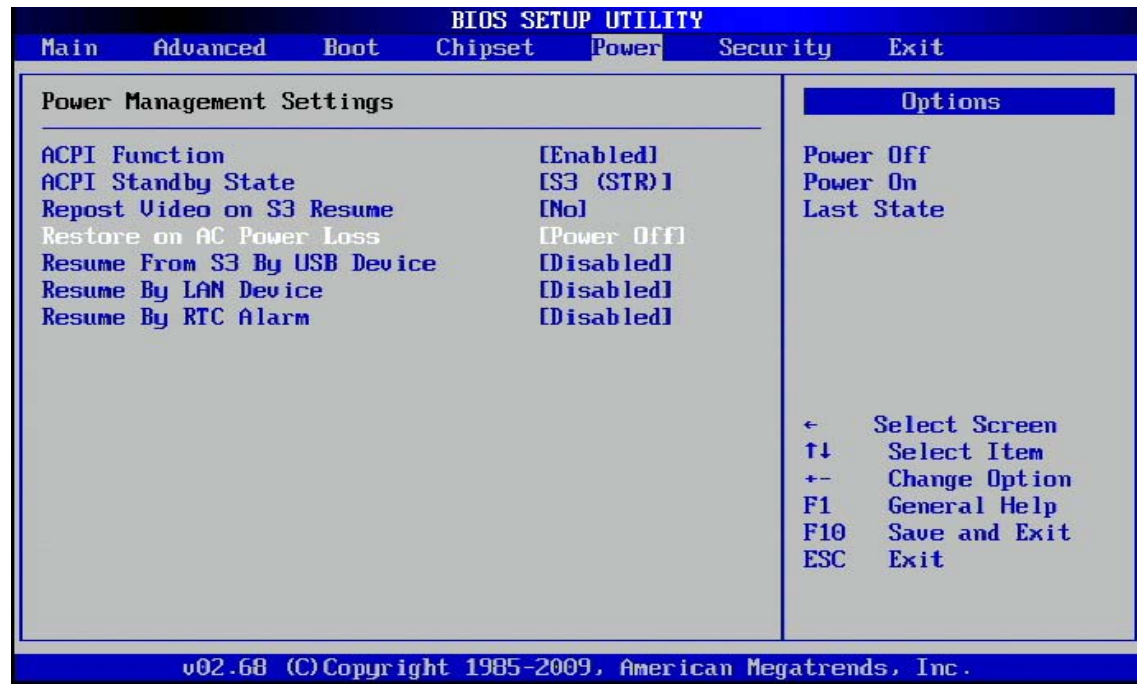

Restore the computer to power up when power is lost. You can set this by entering the computers BIOS setup and configure this setting in the Power Management Settings menu.

Resume From S3 By USB Device

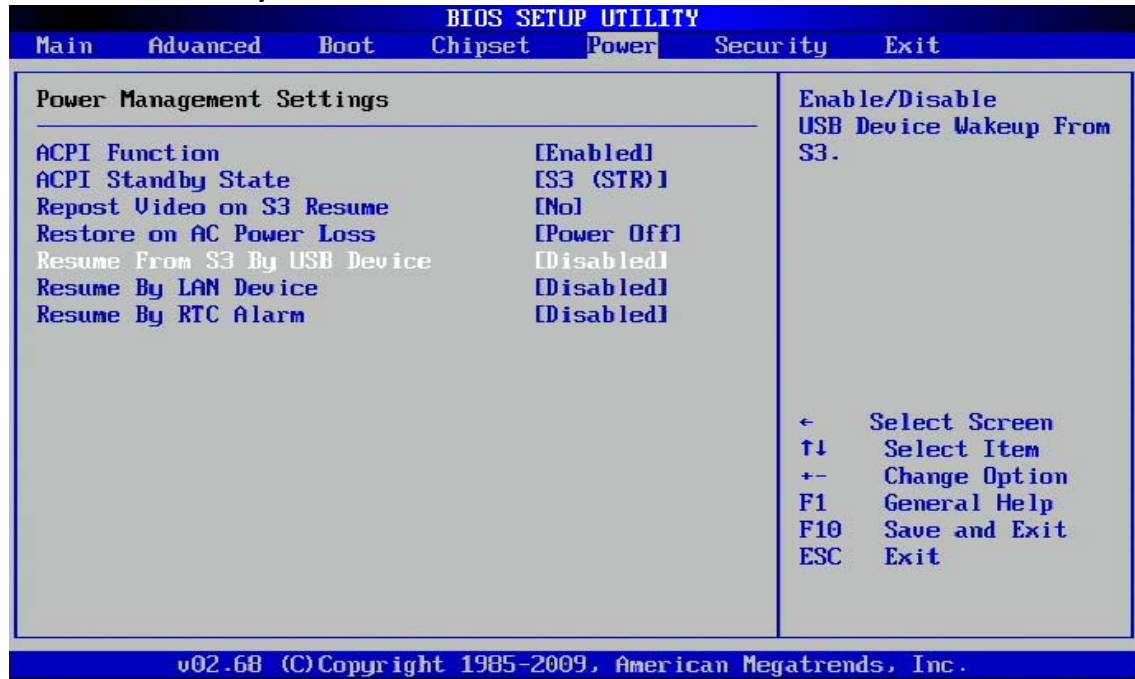

Enable or disable this BIOS setting to wake up the computer by USB Devices

Resume By LAN Device

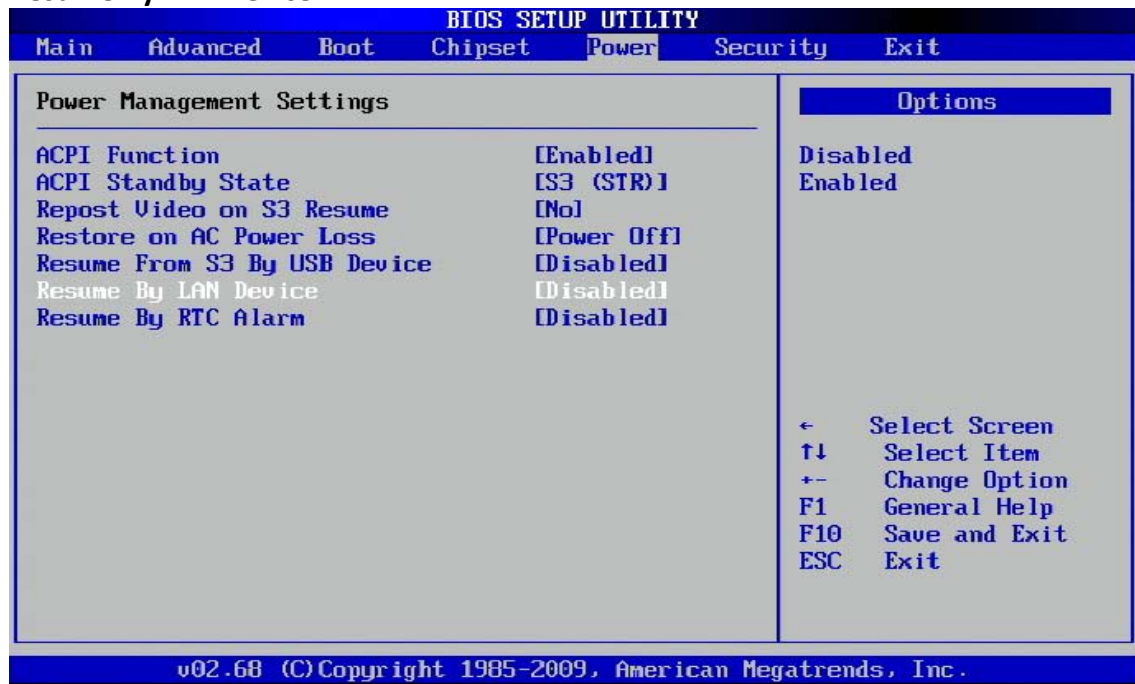

Enable or disable this BIOS setting to wake up the computer by LAN1/LAN2 Port

Resume By RTC Alarm

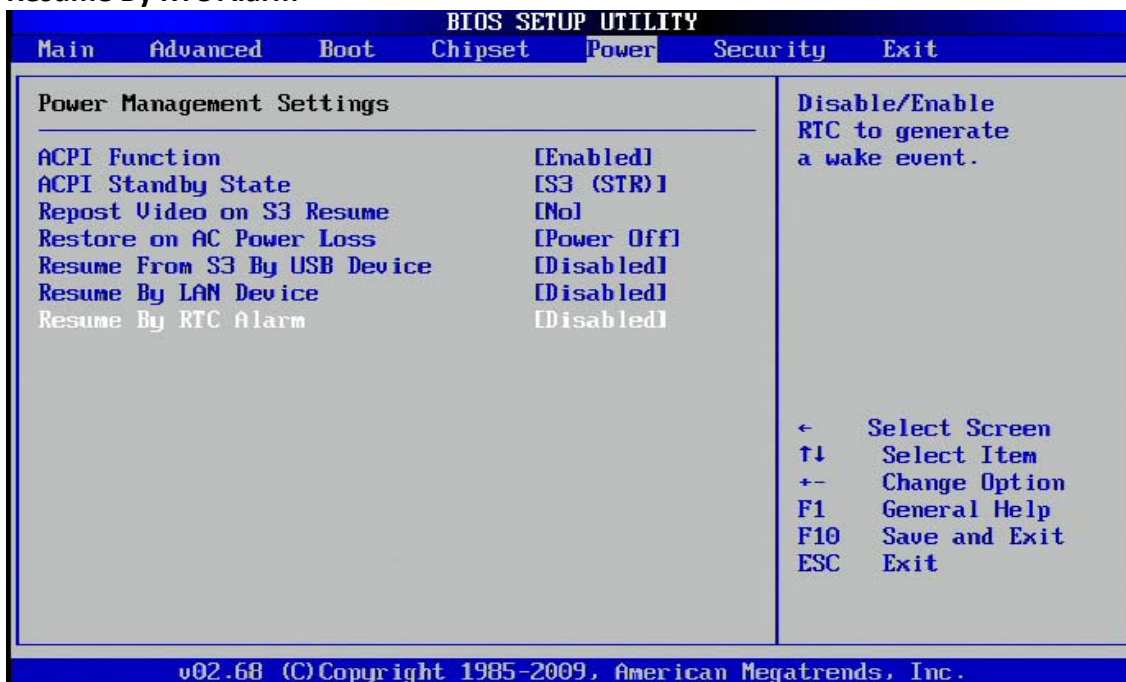

Enable or disable this BIOS setting to wake up the computer by RTC Alarm

4.8 Security Setting

Select this option to set the Security parameters. Select an option to configure. The following settings are available:

Change Supervisor Password: Select to set the supervisor password.

Change User Password: Select to set the user password.

Change Supervisor Password

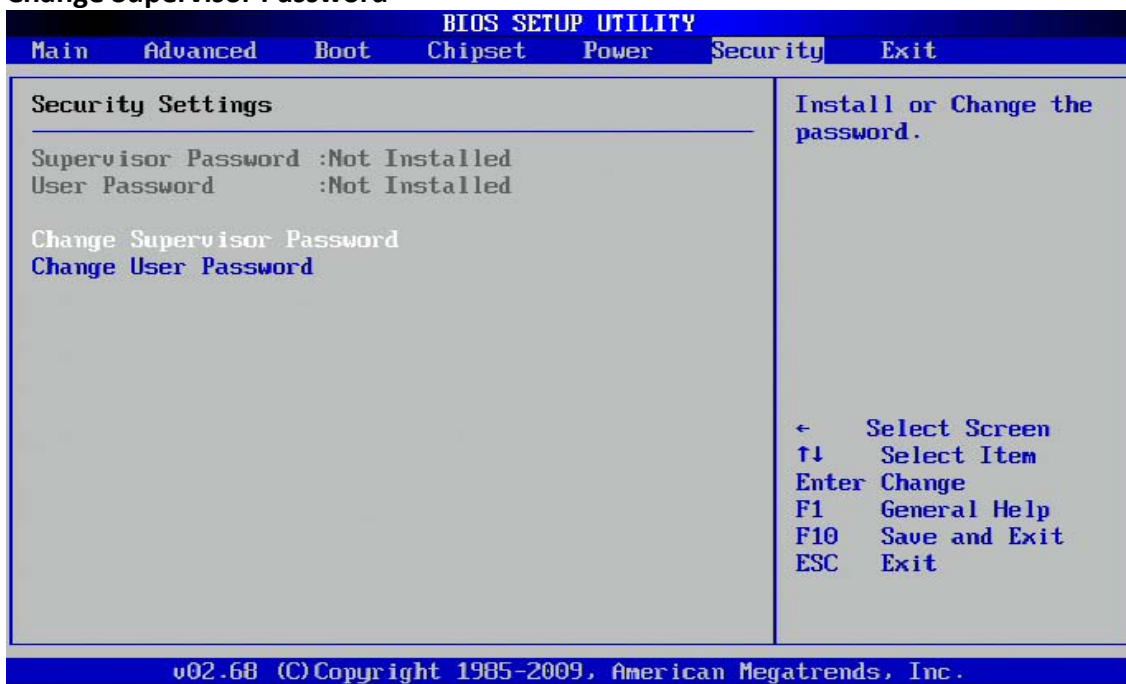

Select this option to set the Supervisor Password parameters.

Change User Password

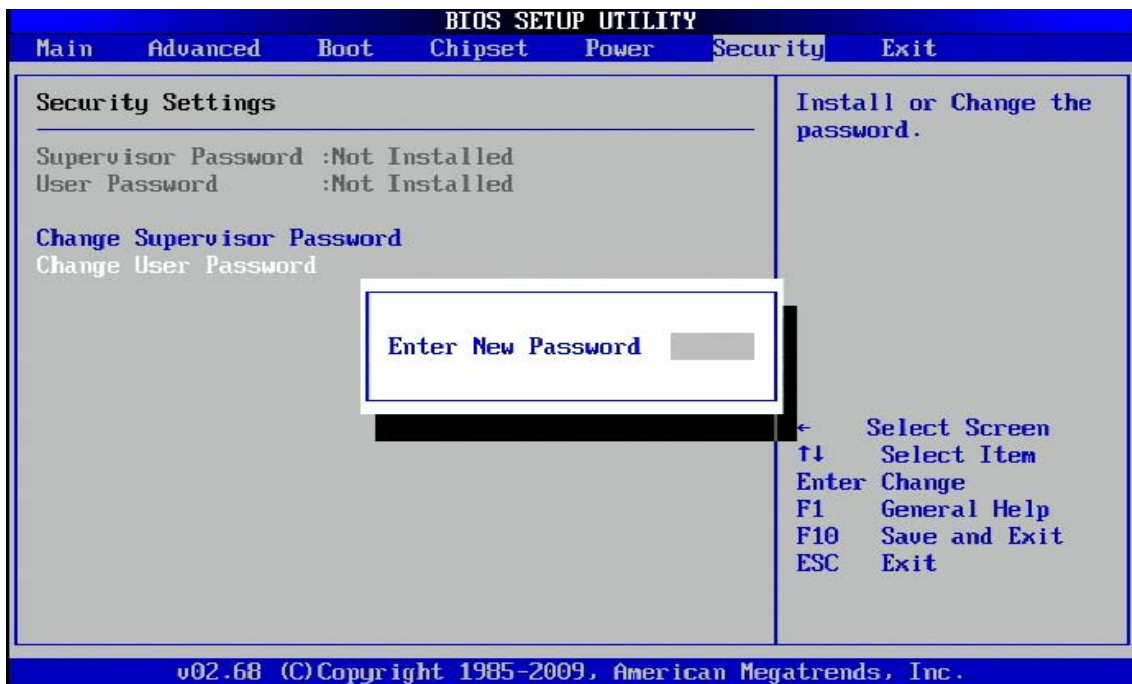
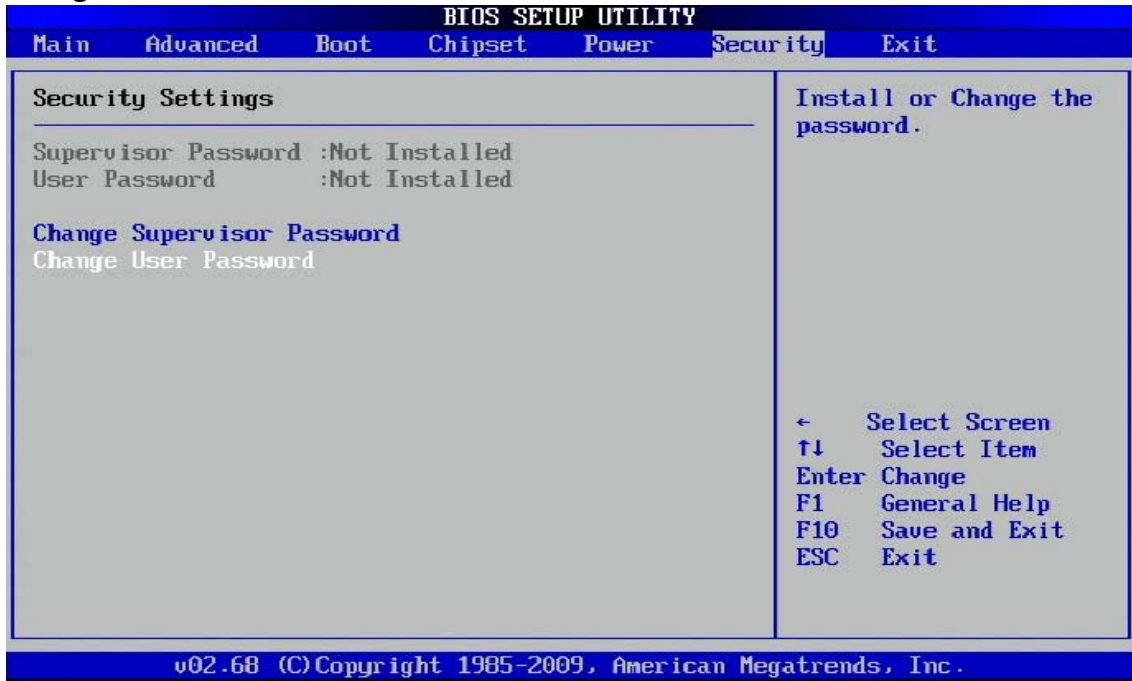

Select this option to set the User Password parameters.

4.9 Exit Setting

Save Changes and Exit

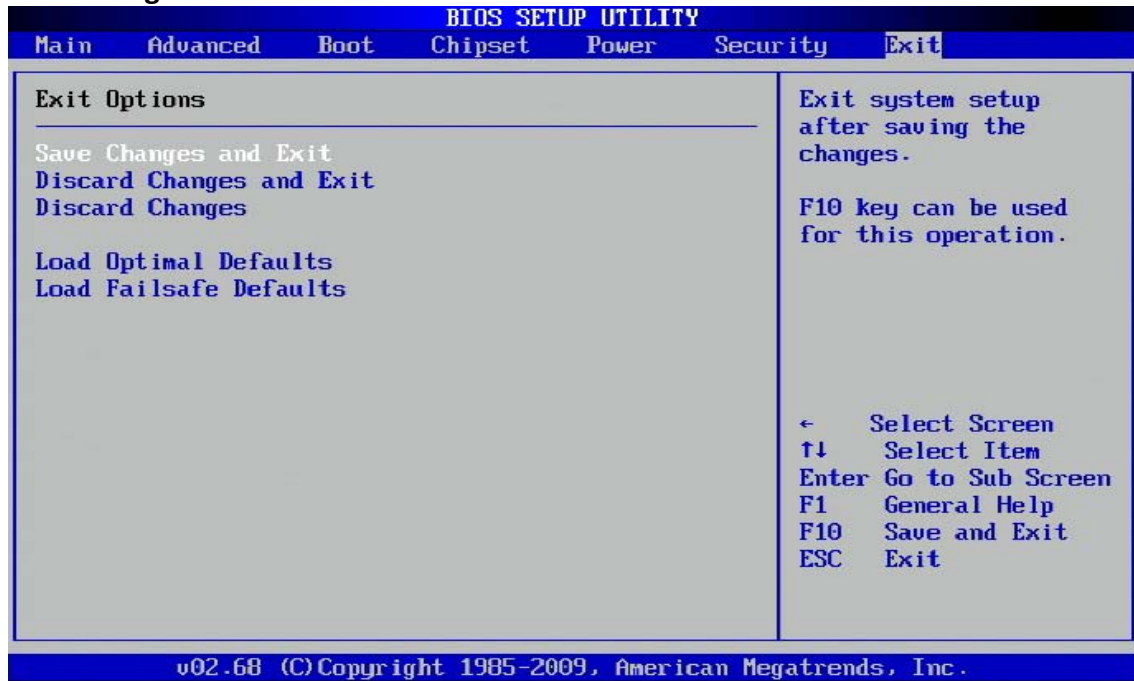

Select this menu to set the Exit parameters. The following settings are available:

- Save Changes and Exit: Select to set this parameter.
- Discard Changes and Exit: Select to set this parameter.
- Discard Changes: Select to set this parameter.
- Load Optimal Defaults: Select to set this parameter.
- Load Failsafe Defaults: Select to set this parameter.

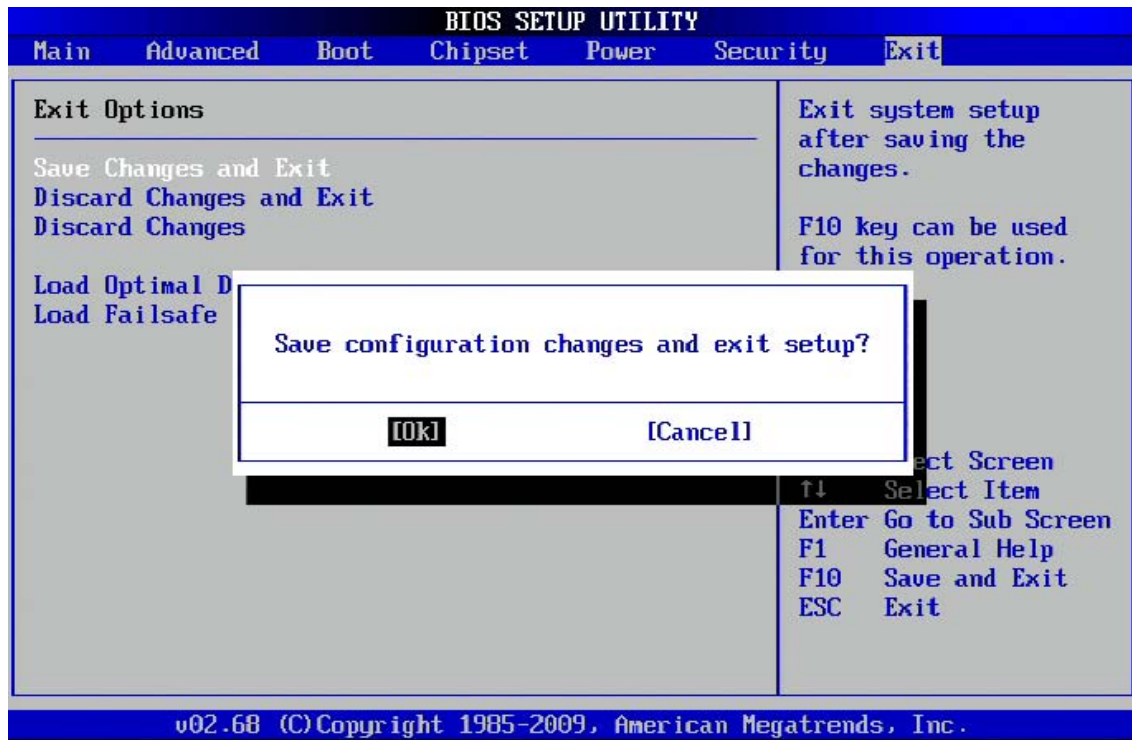

Select this option to save any changes applied and exit the system.

Discard Changes and Exit

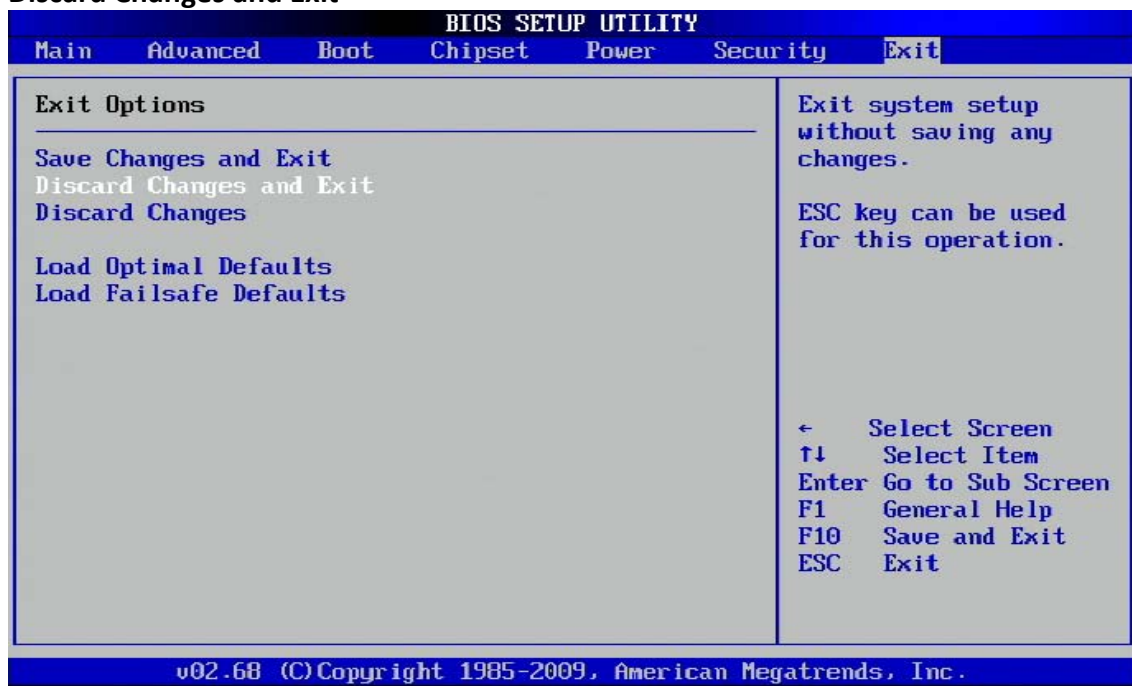

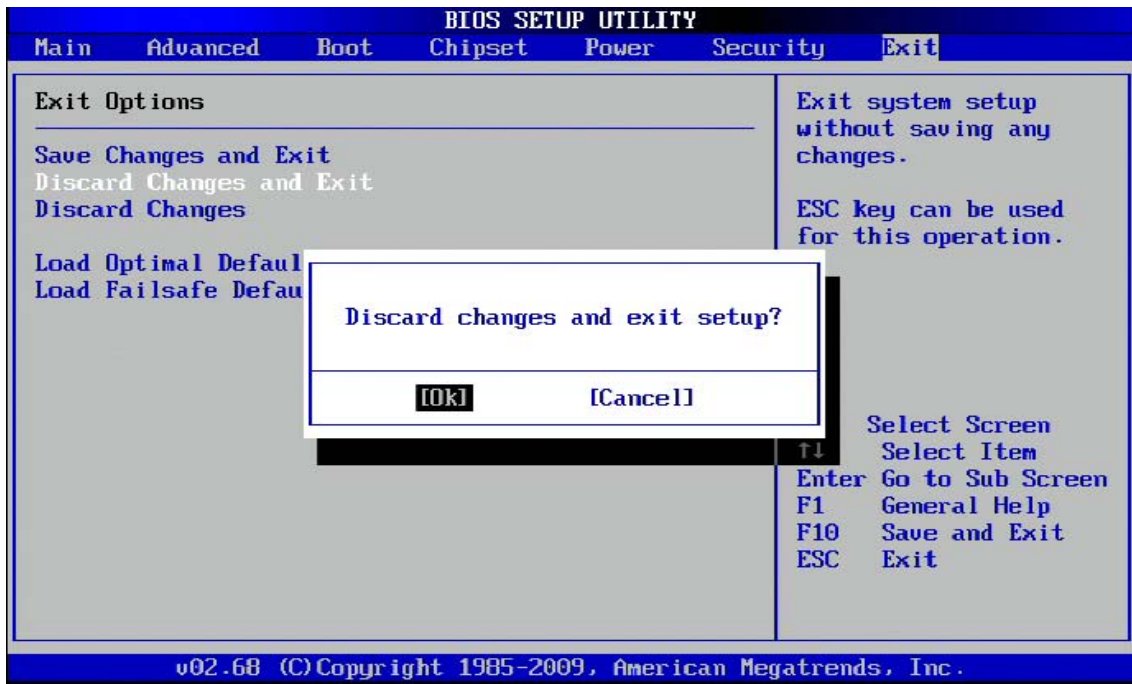

Select this option to discard any changes applied and exit the system.

Discard Changes

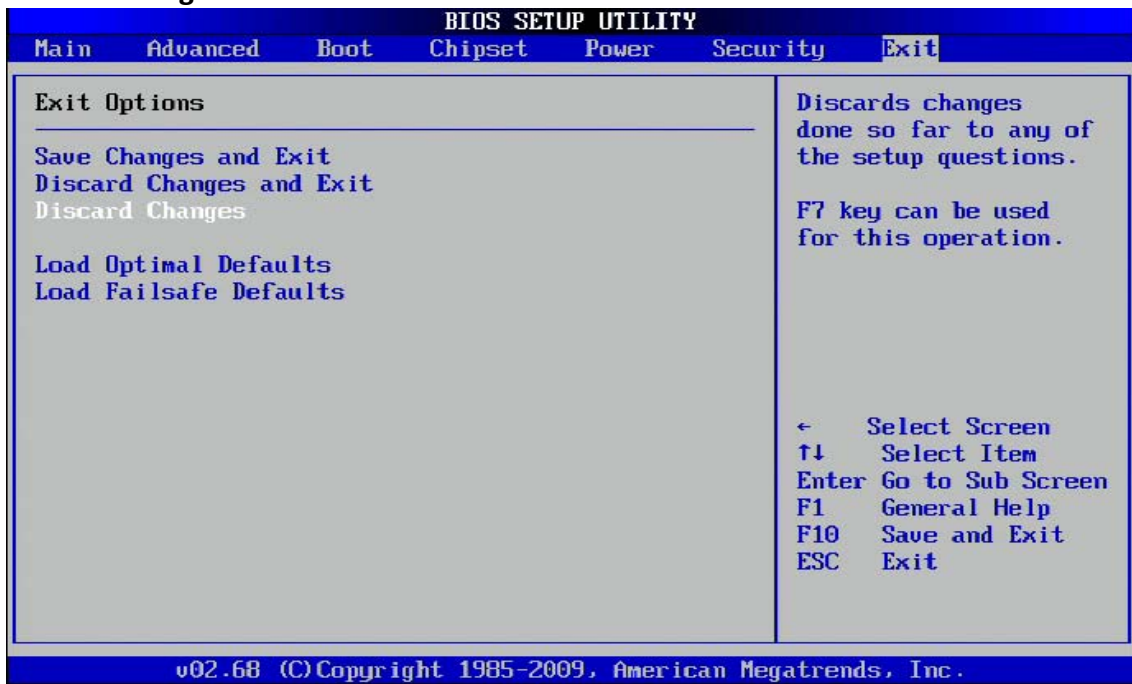

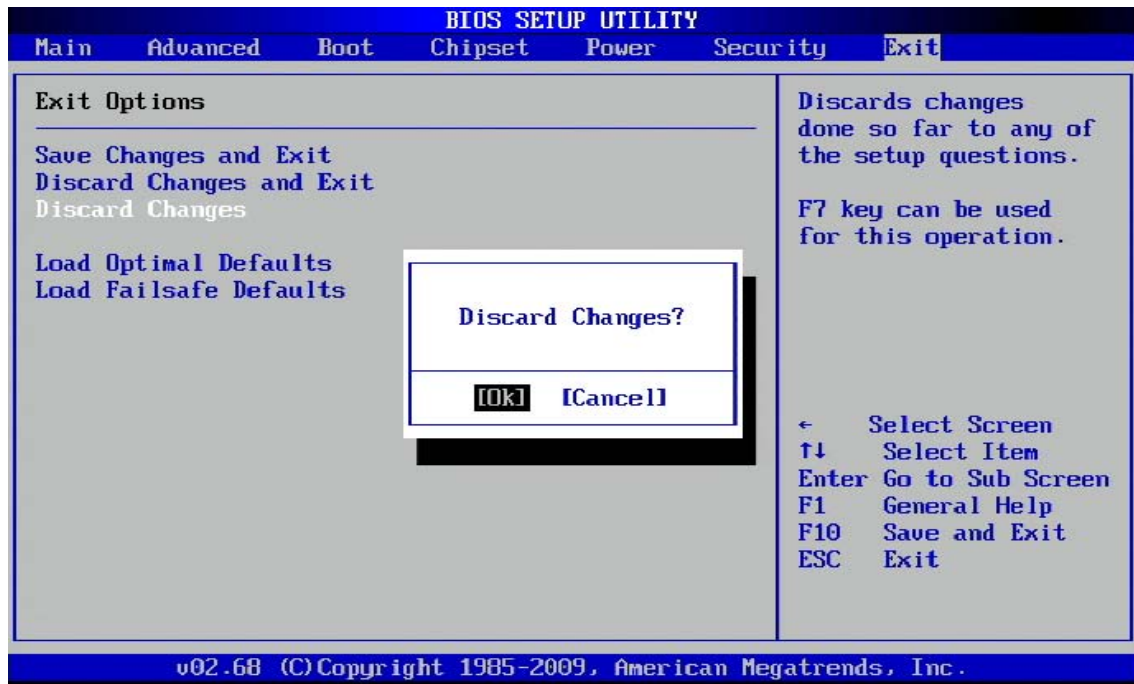

Select this option to discard any changes applied.

Load Optimal Defaults

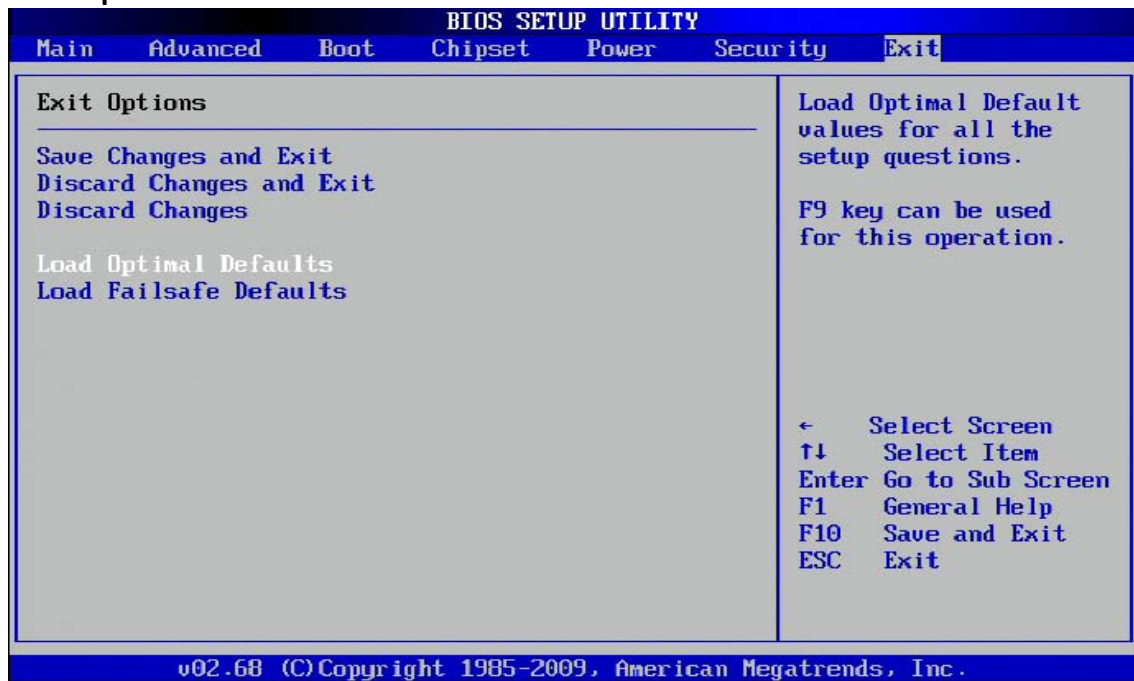

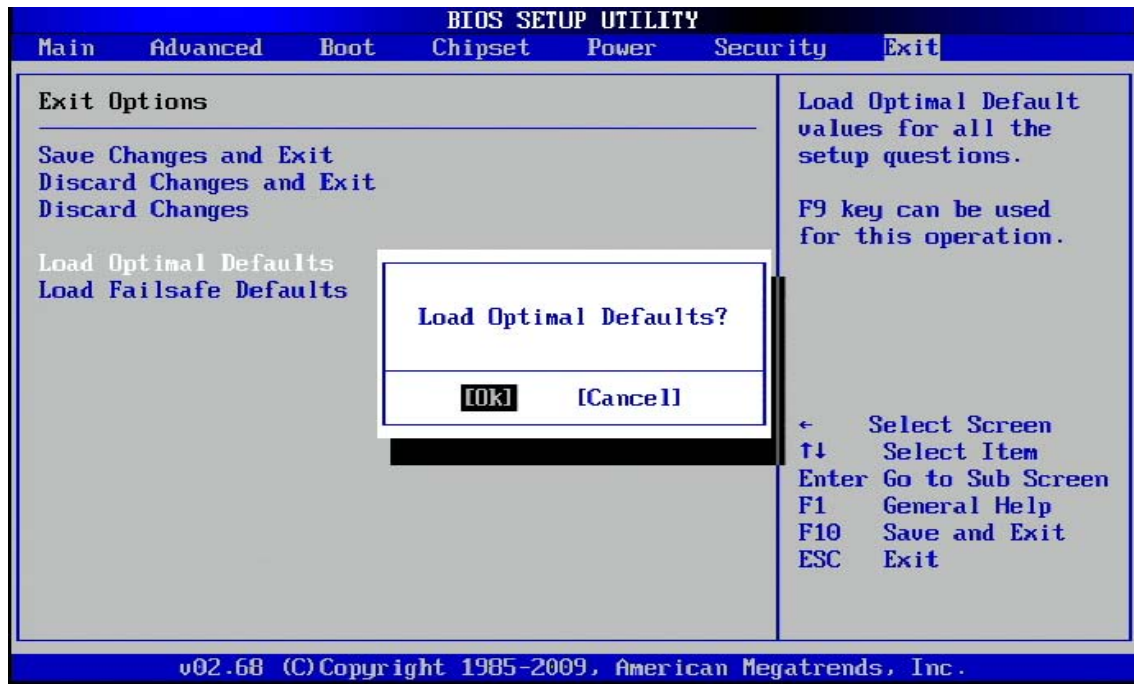

Select this option to load optimal defaults.

Load Failsafe Defaults

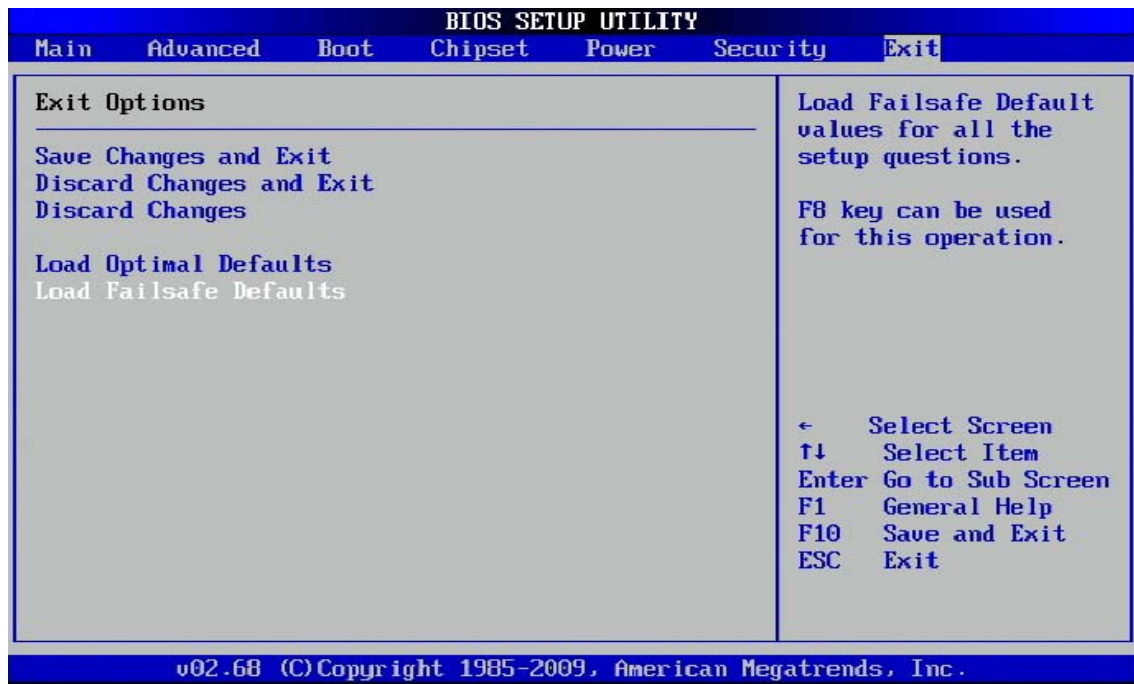

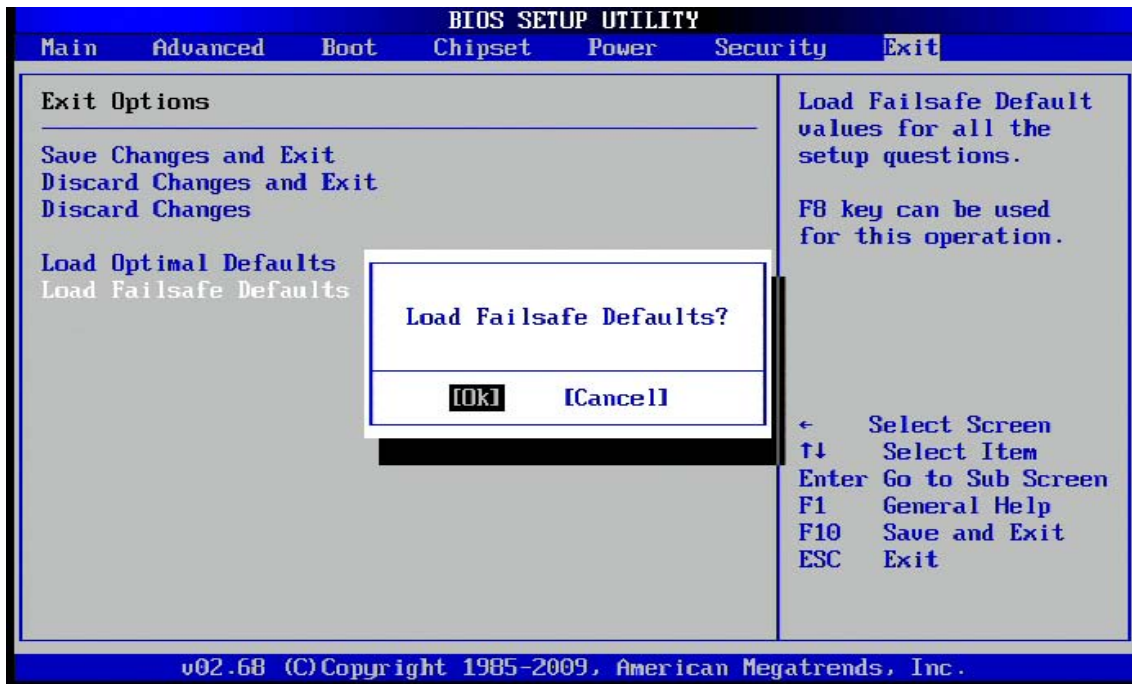

Select this option to load failsafe defaults.

APPENDIX A Watchdog Timer Setting

After the system stops working for a while, it can be auto-reset by the Watchdog Timer. The integrated Watchdog Timer can be set up in the system reset mode by program.

Using the Watchdog Function

Start

↓

Un-Lock WDT

:O 2E 87 ; Un-lock super I/O

O 2E 87 ; Un-lock super I/O

↓

Set WDT Function

O 2E 2D O 2F 20

Select Logic device

O 2E 07

O 2F 08

↓

Activate WDT

:O 2E 30

O 2F 01

Set Second or Minute

O 2E F5

O 2F N N=00 or 08(See below table)

↓

Set base timer

:O 2E F6

O 2F M=00,01,02,...FF(Hex) ,Value=0 to 255

↓

WDT counting

re-set timer :O 2E F6
O 2F M ; M=00,01,02,...FF(See below table)
↓
IF No re-set timer :WDT time-out, generate RESET

IF to disable WDT :O 2E 30
O 2F 00 ; Can be disable at any time

N=00
M= 00h: Time-out Disable
01h: Time-out occurs after 1 second
02h: Time-out occurs after 2 second
03h: Time-out occurs after 3 second
.....
FFh: Time-out occurs after 255 second

N=08
M= 00h: Time-out Disable
01h: Time-out occurs after 1 minute
02h: Time-out occurs after 2 minutes
03h: Time-out occurs after 3 minutes
.....
FFh: Time-out occurs after 255 minutes

APPENDIX B DIGITAL I/O

Digital I/O Software Programming
 Program Example: 4IN/4OUT (W83627DHG)

GPI	GPO
O 2E 87	O 2E 87
O 2E 87	O 2E 87
O 2E 07	O 2E 07
O 2F 09	O 2F 09
O 2E 30	O 2E 30
O 2F 02	O 2F F2
O 2E F0	O 2E F0
O 2F F0	O 2F F0
O 2E F1	O 2E F1
I 2F	O 2F M(Note)



Pin	Signal	Pin	Signal
1	DI1	2	DO1
3	DI2	4	DO2
5	DI3	6	DO3
7	DI4	8	DO4
9	GND	10	GND

Note:

Digital Output				Digital Input			
Bit7	Bit6	Bit5	Bit4	Bit3	Bit2	Bit1	Bit0
DI4	DI3	DI2	DI1	DO4	DO3	DO2	DO1