

MB961 Series

Intel 2nd Gen. Core™ i Desktop CPU
+ H61/Q67

Sugar Bay based Micro ATX MB

USER'S MANUAL

Version 1.0

Acknowledgments

AMI is a registered trademark of American Megatrends Inc.
PS/2 is a trademark of International Business Machines Corporation.

Intel and Intel® Core i are registered trademarks of Intel Corporation.

Microsoft Windows is a registered trademark of Microsoft Corporation.

Fintek is a registered trademark of Fintek Electronics Corporation.

All other product names or trademarks are properties of their respective owners.

Table of Contents

Introduction	1
Product Description.....	1
Checklist.....	2
MB961 Series Specifications.....	3
Board Dimensions	5
Installations	6
Installing the CPU	7
Installing the Memory.....	8
Setting the Jumpers.....	9
Connectors on MB961Series	15
BIOS Setup	29
Drivers Installation	53
Intel Chipset Software Installation Utility.....	54
VGA Drivers Installation.....	56
Realtek HD Audio Driver Installation	58
LAN Drivers Installation	59
Realtek LAN Controller Drivers Installation	61
Intel® Management Engine Interface	64
ASMedia USB 3.0 Drivers	67
Appendix	69
A. I/O Port Address Map.....	69
B. Interrupt Request Lines (IRQ).....	70
C. Watchdog Timer Configuration	71

This page is intentionally left blank.

Introduction

Product Description

The MB961 Series Micro ATX motherboard is based on the latest Intel® H61/Q67 Express chipset. The platform supports 2nd generation Intel® Core™ processor family with LGA1155 packing and features an integrated dual-channel DDR3 memory controller as well as a graphics core.

The latest Intel processors provide advanced performance in both computing and graphics quality. The MB961 Series board utilizes the dramatic increase in performance provided by this Intel's latest cutting-edge technology. This meets the requirement of customers in the gaming, POS, digital signage and server market segment.

Measuring 244mm x 244mm, the MB961 Series offers 3Gbps/6Gbps SATA support, USB3.0 (2 ports) and interfaces for DVI-I, HDMI and LVDS displays.

MB961 Series FEATURES:

- Supports Intel 2nd Generation Core i7/i5/i3 QC/DC desktop processors
- Two DDR3 DIMM, 1066/1333MHz; supports up to 16GB memory
- One Intel PCI-Express Gigabit LAN and one Realtek PCI-Express Gigabit LAN
- Integrated Graphics for DVI-I and HDMI (MB961F/MB961RF only) displays
- Support LVDS 24 bit dual channel for MB961F/MB961RF only
- 4x SATA 2.0 for MB961/MB961F, 2x SATA 2.0 and 2x SATA 3.0 for MB961RF, 10x USB 2.0, 2x USB 3.0 for MB961/MB961F, 12x USB, 2.0, 2x USB 3.0 for MB961RF
- 4x COM, Watchdog timer
- Supports LPT port for MB961 only
- 1x PCI-E (x16), 1x PCI-E (x8) Slot (MB961/MB961F only supports PCIE x1 lane, MB961RF supports PCIE x1 lane or PCIE x4 lanes)

Checklist

Your MB961 Series package should include the items listed below.

- The MB961 Series motherboard
- This User's Manual
- 1 CD containing chipset drivers and flash memory utility
- Serial ATA cable

MB961 Series Specifications

Product Name	MB961RF (Q67 based) MB961F (H61 based) MB961 (H61 based)
Form Factor	Micro ATX
CPU Type	Intel® 2 nd generation Core™ i7/i5/i3/Pentium®/Celeron® DT processor TDP for QC= 95W/65W/45W;DC= 65W/35W [Package = FC-LGA10, 37.5 mm x 37.5mm]
CPU Speed	Up to 3.40 GHz
Cache Size	Up to 8MB shared L2 Cache
CPU Socket	LGA1155 (Socket H2)
Chipset	Intel® BD82H61 PCH for MB961/MB961F (TDP=6.1W) or BD82Q67 PCH for MB961RF [27mm x 27mm, 942-pin FCBGA package]
BIOS	AMI BIOS, support ACPI Function
Memory	Intel® 2 nd generation Core™ i7/i5/i3/Pentium®/Celeron® DT processor integrated memory controller support DDR3-1600 (Non-ECC) UDIMM x 2, Max. 16GB
VGA	Intel® 2 nd generation Core™ i7/i5/i3/Pentium® DT processor integrated Gfx(HD2000/HD3000) <ul style="list-style-type: none"> ● DVI-I x 1 (thru Level shifter ASM1442) ● HDMI x 1 for MB961F/MB961RF only ● LVDS (thru CH7511 via DP) for MB961F/MB961RF only
LAN	Intel 82579V PCIe Gigabit LAN PHY x 1 Realtek RTL8111E PCIe Gigabit LAN controller x1
USB	USB 2.0 host controller, supports 10/12 ports <ul style="list-style-type: none"> - 4 ports in the rear panel. - 6 ports for onboard pin header (MB961/MB961F) or 8 ports for onboard pin header (MB961RF) USB 3.0 host controller (ASM1042), support 2 ports <ul style="list-style-type: none"> - 2 ports in the rear panel
Serial ATA	Intel® H61/Q67 PCH build-in SATA controller, Supports 4 ports x SATA 2.0 from H61 PCH (MB961/MB961F) Supports 2 ports x SATA 3.0 + 2 ports x SATA 2.0 from Q67 PCH (MB961RF)
Audio	Intel® H61/Q67 PCH built-in High Definition Audio controller: ALC892 w/ 7.1 channels
LPC I/O	Fintek F81866AD-I COM1 (RS232/422/485) [Auto flow control/ Jumper less selection]; COM2~4 (RS232 only) COM1/2 with pin-9 with power for 2 ports (500 mA each) Hardware Monitor (2 thermal inputs, 4 voltage monitor inputs & 2 Fan headers) CPU Fan = 4-pin type (PWM); SYS Fan= 3-pin type (DC) LPT port (MB961 only)
Digital IO	4 in & 4 out

Expansion Slots	<p>PCIe (16x) x1 PCIe (8x) x1 **Actual signal will be PCIe(4x) for MB961RF or PCIe(1x) for MB961F/MB961F** PCI x2 [Thru ITE8893 PCIe to PCI converter]</p>
Edge Connector	<p>Dual DB9 stack connector for COM #1, #2 DVI-I connector x1 Dual USB (3.0) stack connector x1 HDMI x1 (for MB961F/MB961RF only) RJ-45 GbE + dual USB (2.0) stack connector x2 RCA Jack 3x1 for HD Audio</p>
Onboard Header/Connector	<p>-4 ports x SATA II (MB961/MB961F) or 2 ports x SATA II + 2 ports x SATA III (MB961RF) -2x5 pin-header x 3 for 6 ports USB 2.0 (MB961/MB961F) or 2x5 pin-header x4 for 8 ports USB 2.0 (MB961RF) -2x5 pin-header x 1 for front panel audio -DF11-10 box header x1 for COM3 -DF11-10 box header x1 for COM4 -2x5 pins pin-header x1 for Digital I/O -2x13 pin-header x1 for LPT (MB961) -2x5 pins male connector [for debugging purpose] -2x10 pins pin-header x 1 for front panel indicators+2x2 pins pin header for ACPI LED (For MB961) -DF13-20pin x2 for 24-bit dual channel LVDS (MB961F/MB961RF) 4-pin JST header [pitch=2.5] for brightness control (MB961F /MB961RF)</p>
Watchdog Timer	Yes (256 segments, 0, 1, 2...255 sec/min)
System Voltage	+5V, +3.3V, +12V, -12V, 5VSB (2A) 24-pin ATX main power + 4-pin 12V
Other	<ul style="list-style-type: none"> - iSMART controller [EuP/ErP ; Auto-scheduler ; Power resume] - ACPI LED function (MB961 only) - RAID function (M961RF only)
RoHS	Yes
Board Size	244mm x 244mm

Board Dimensions

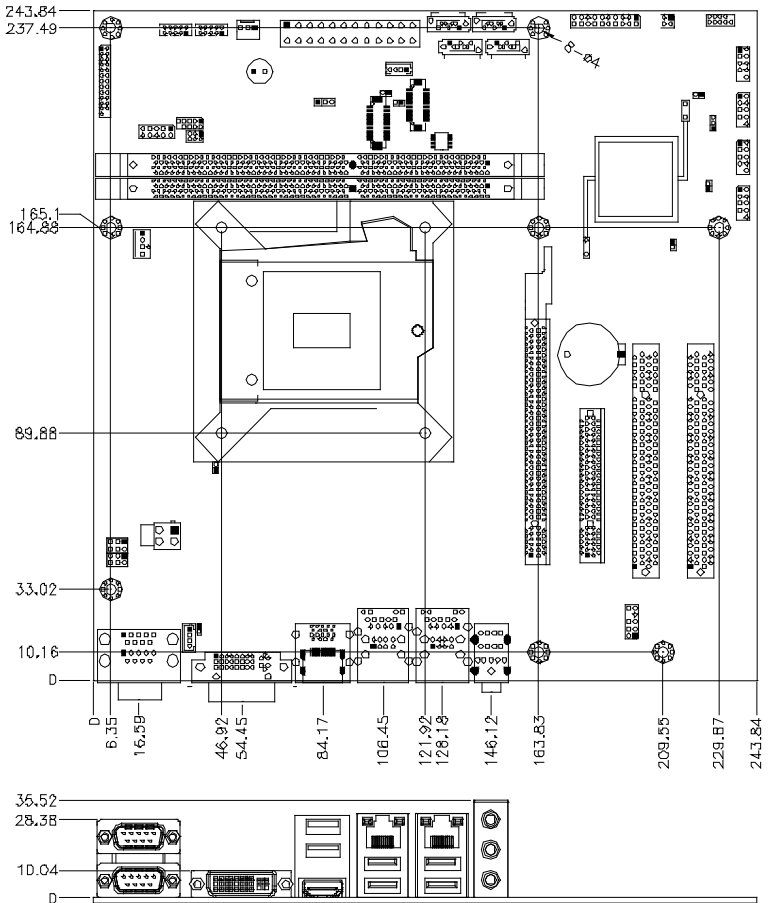

Installations

This section provides information on how to use the jumpers and connectors on the MB961 Series in order to set up a workable system.

The topics covered are:

Installing the CPU.....	7
Installing the Memory	8
Setting the Jumpers.....	9
Connectors on MB961Series	15

Installing the CPU

The MB961 Series board supports an LGA1155 Socket (shown below) for Intel Sandy Bridge processors.

To install the CPU, unlock first the socket by pressing the lever sideways, then lift it up to a 90-degree. Then, position the CPU above the socket such that the CPU corner aligns with the gold triangle matching the socket corner with a small triangle. Carefully insert the CPU into the socket and push down the lever to secure the CPU. Then, install the heat sink and fan.

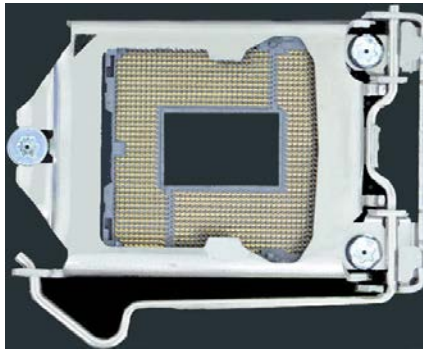

NOTE: *Ensure that the CPU heat sink and the CPU top surface are in total contact to avoid CPU overheating problem that would cause your system to hang or be unstable.*

Installing the Memory

The MB961 Series board supports four DDR3 memory socket for a maximum total memory of 16GB in DDR3 DIMM memory type.

Installing and Removing Memory Modules

To install the DDR3 modules, locate the memory slot on the board and perform the following steps:

1. Hold the DDR3 module so that the key of the DDR3 module aligned with that on the memory slot.
2. Gently push the DDR3 module in an upright position until the clips of the slot close to hold the DDR3 module in place when the DDR3 module touches the bottom of the slot.
3. To remove the DDR3 module, press the clips with both hands.

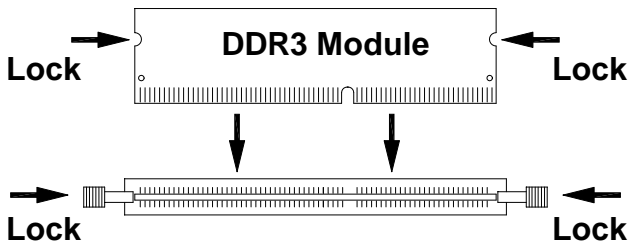

Setting the Jumpers

Jumpers are used on MB961 Series to select various settings and features according to your needs and applications. Contact your supplier if you have doubts about the best configuration for your needs. The following lists the connectors on MB961 Series and their respective functions.

Jumper Locations on MB961 Series	10
JP1: COM1 RS232 RI/+5V/+12V Power Setting.....	11
JP2: COM2 RS232 RI/+5V/+12V Power Setting.....	11
JP4: Flash Descriptor Security Override (Factory use only).....	12
JP5: LCD Panel Power Selection (MB961F/MB961RF only).....	12
JP6: Factory use only (Default: open)	12
JP7: LCD Brightness +3.3V/+5V Power Setting	13
JBAT1: Clear CMOS Contents	13
JP9: LVDS function select	13
SW1: Panel Type Selection (MB961F/MB961RF only).....	14

Jumper Locations on MB961 Series

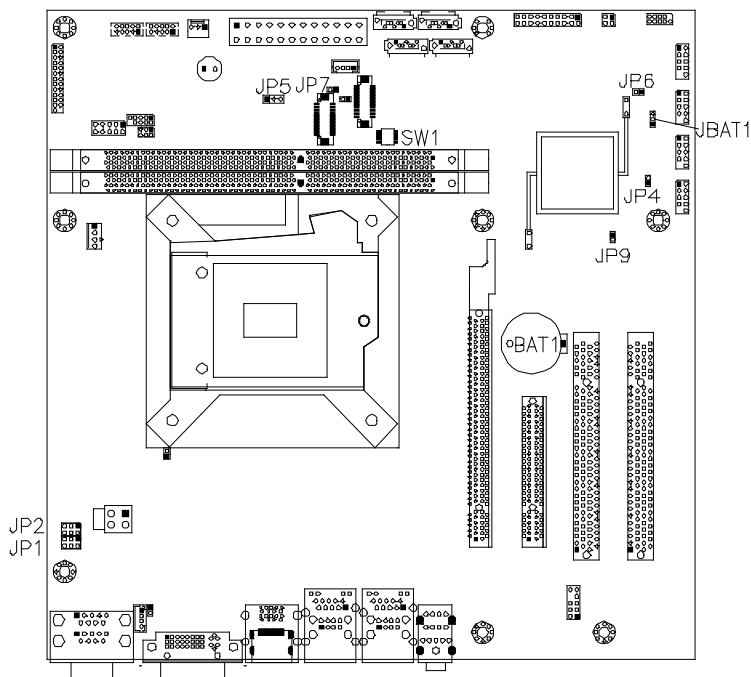

Jumpers on MB961 Series	Page
JP1: COM1 RS232 RI/+5V/+12V Power Setting.....	11
JP2: COM2 RS232 RI/+5V/+12V Power Setting.....	11
JP4: Flash Descriptor Security Override (Factory use only).....	12
JP5: LCD Panel Power Selection (MB961F/MB961RF only).....	12
JP6: Factory use only (Default: open)	12
JP7: LCD Brightness +3.3V/+5V Power Setting.....	13
JBAT1: Clear CMOS Contents.....	13
JP9: LVDS function select.....	13
SW1: Panel Type Selection (MB961F/MB961RF only).....	14

JP1: COM1 RS232 RI/+5V/+12V Power Setting

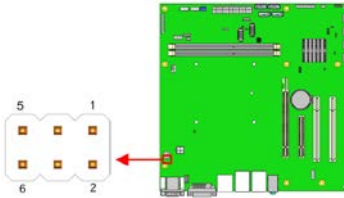

JP1	Setting	Function
	Pin 1-3 Short/Closed	+12V
	Pin 3-4 Short/Closed	RI
	Pin 3-5 Short/Closed	+5V

JP2: COM2 RS232 RI/+5V/+12V Power Setting

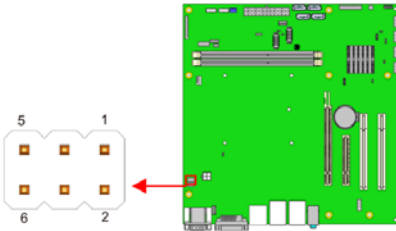

JP2	Setting	Function
	Pin 1-3 Short/Closed	+12V
	Pin 3-4 Short/Closed	RI
	Pin 3-5 Short/Closed	+5V

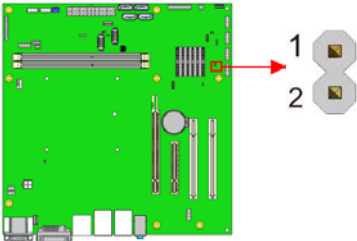

JP4: Flash Descriptor Security Override (Factory use only)

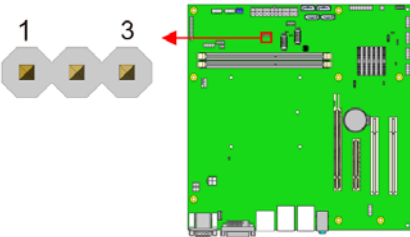

JP4	Flash Descriptor Security Override
Open	Disabled (Default)
Close	Enabled

JP5: LCD Panel Power Selection (MB961F/MB961RF only)



JP5	LCD Panel Power
 1 2 3	+3.3V*
 1 2 3	+5V

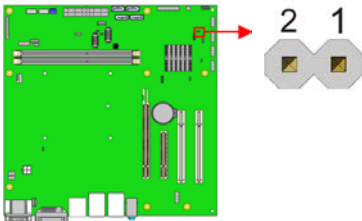

JP6: Factory use only (Default: open)



JP7: LCD Brightness +3.3V/+5V Power Setting

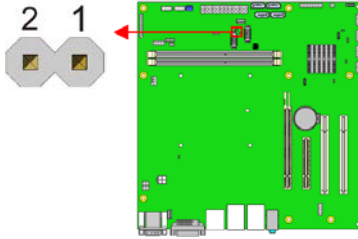

(MB961F/MB961RF only)

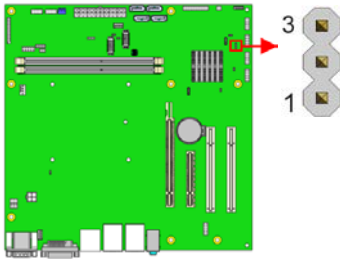

JP7	Setting
	+3.3V*
	+5V

JBAT1: Clear CMOS Contents



JBAT1	Setting	Function
	Pin 1-2 Short/Closed	Normal
	Pin 2-3 Short/Closed	Clear CMOS

JP9: LVDS function select

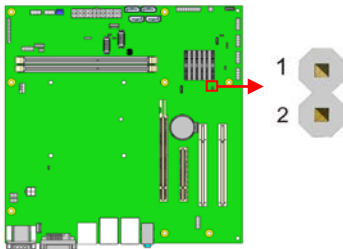

JP9	LVDS function select
Open	Disabled
Close	Enabled (Default)

SW1: Panel Type Selection

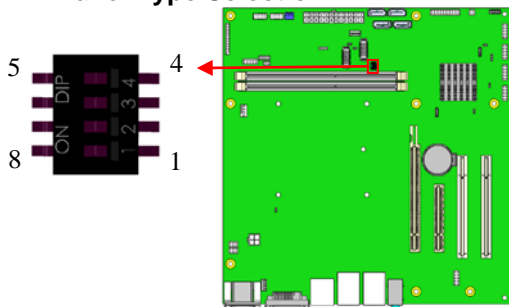

**(Default: Pin 4,3,2,1 (ON ON ON OFF))
(MB961F/MB961RF only)**

SW1-4	SW1-3	SW1-2	SW1-1	Panel Type
ON	ON	ON	ON	800*600 18bit 1ch
ON	ON	ON	OFF	1024*768 18bit 1ch *
ON	ON	OFF	ON	1024*768 24bit 1ch
ON	ON	OFF	OFF	1280*768 18bit 1ch
ON	OFF	ON	ON	1280*800 18bit 1ch
ON	OFF	ON	OFF	1280*960 18bit 1ch
ON	OFF	OFF	ON	1280*1024 24bit 2ch
ON	OFF	OFF	OFF	1366*768 18bit 1ch
OFF	ON	ON	ON	1366*768 24bit 1ch
OFF	ON	ON	OFF	1440*900 24bit 2ch
OFF	ON	OFF	ON	1440*1050 24bit 2ch
OFF	ON	OFF	OFF	1600*900 24bit 2ch
OFF	OFF	ON	ON	1680*1050 24bit 2ch
OFF	OFF	ON	OFF	1600*1200 24bit 2ch
OFF	OFF	OFF	ON	1920*1080 24bit 2ch
OFF	OFF	OFF	OFF	1920*1200 24bit 2ch

Connectors on MB961Series

Connector Locations on MB961 Series	16
CN3: COM1 and COM2 Serial Ports	17
CN1: DVI-I Connector	17
CN5: USB3.0 Connector	18
CN2: HDMI Connector (<i>MB961F/MB961RF only</i>)	18
CN7: Intel Gigabit LAN + USB 10/11	18
CN6: Realtek Gigabit LAN + USB 2/3	18
CN4: HD Audio Connector	18
CN8: LCD Backlight Connector (<i>MB961F/MB961RF only</i>)	18
CN9, CN11: SATA2 Connectors	19
CN10, CN12: SATA2 or SATA3 Connectors	19
<i>MB961 supports SATA2 (3Gbps)</i>	
<i>MB961F supports SATA2 (3Gbps) and SATA3 (6Gbps)</i>	
CH1, CH2: LVDS Connectors (1st channel, 2nd channel)	20
(For <i>MB961F/MB961RF only</i>)	
J1: MCU JTAG (for debug use)	20
J3: Audio Pin Header for Chassis Front Panel	21
J4: ATX 12V Power Connector	21
J5, J9, J12, J14: USB Connectors	22
(<i>J12 is supported by MB961RF only</i>)	
J6, J8, DDR3 DIMM Sockets	22
J10: Digital I/O	22
J11: LPC Connector (for debug use)	23
J13: Parallel Port Connector (<i>MB961 only</i>)	23
J16, J17: COM3, COM4 RS232 Serial Ports	
J15: 24-pin ATX Power Connector	24
J18: ACPI LED Connector (<i>MB961 only</i>)	25
J19: Front Panel Function Connector	25
J20: SPI Connector (For debug use)	26
J21: LPC signal connector	26
CPU_FAN1: CPU Fan Power Connector	26
SYS_FAN1: System Fan1 Power Connector	27
PCIE1: PCIE x8 Slot	27
PCIE2: PCI-E X16 Slot	27
PCI3, PCI4: PCI Slot	28

Connector Locations on MB961 Series

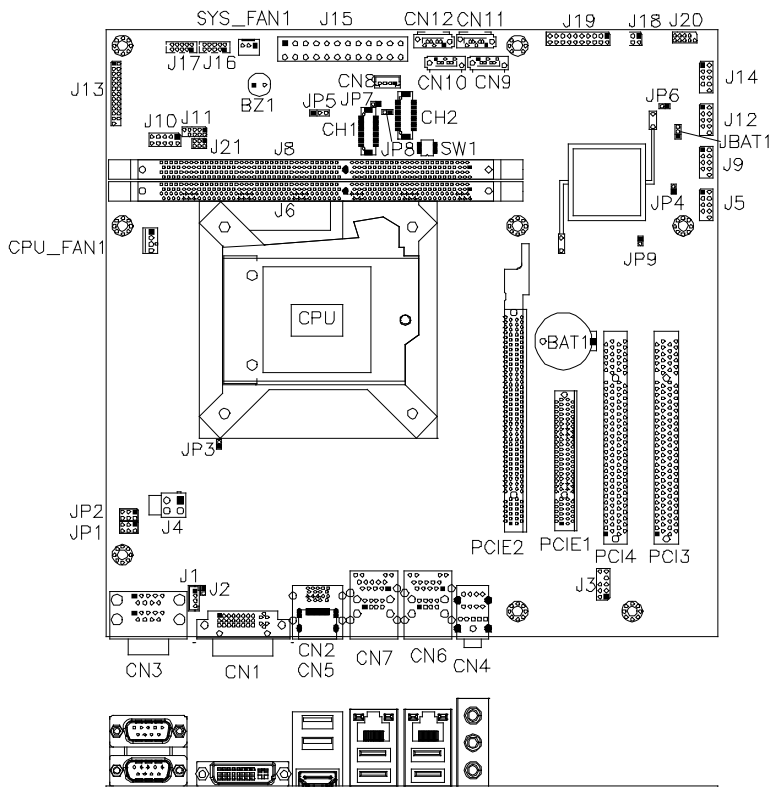

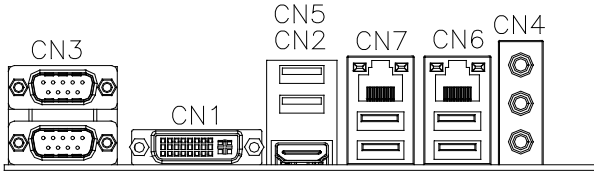

CN3: COM1 and COM2 Serial Ports

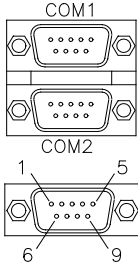

Pin #	Signal Name		
	RS-232	R2-422	RS-485
1	DCD	TX-	DATA-
2	RX	TX+	DATA+
3	TX	RX+	NC
4	DTR	RX-	NC
5	Ground	Ground	Ground
6	DSR	NC	NC
7	RTS	NC	NC
8	CTS	NC	NC
9	RI	NC	NC
10	NC	NC	NC

CN1: DVI-I Connector

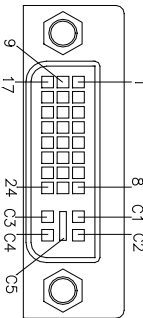

Signal Name	Pin #	Pin #	Signal Name
DATA 2-	1	16	Hot_Plug_Detect
DATA 2+	2	17	DATA 0-
Shield 2/4	3	18	DATA 0+
DATA 4-	4	19	SHIELD 0/5
DATA 4+	5	20	DATA 5-
DDC CLOCK	6	21	DATA 5+
DDC DATA	7	22	SHIELD CLK
CRT_VSYNC	8	23	CLOCK -
DATA 1-	9	24	CLOCK +
DATA 1+	10	C1	CRT_R
SHIELD 1/3	11	C2	CRT_G
DATA 3-	12	C3	CRT_B
DATA 3+	13	C4	CRT_HSYNC
DDC POWER	14	C5	A GROUND2
A GROUND 1	15	C6	A GROUND3

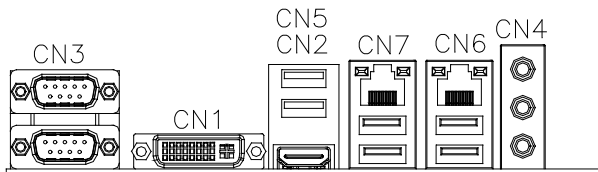

CN5: USB3.0 Connector

CN2: HDMI Connector (*MB961F/MB961RF only*)

CN7: Intel Gigabit LAN + USB 10/11

CN6: Realtek Gigabit LAN + USB 2/3

CN4: HD Audio Connector

CN8: LCD Backlight Connector (*MB961F/MB961RF only*)

1X4_2.0mm_Straight_M (JST B4B-PH-K-S)

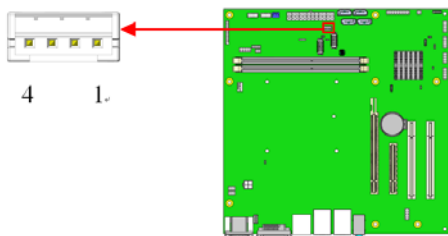

Pin #	Signal Name
1	+12V
2	Backlight Enable
3	Brightness Control
4	Ground

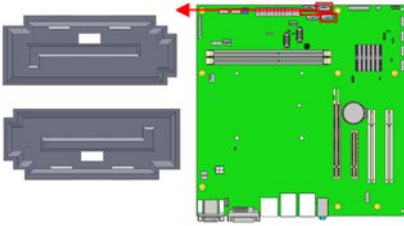
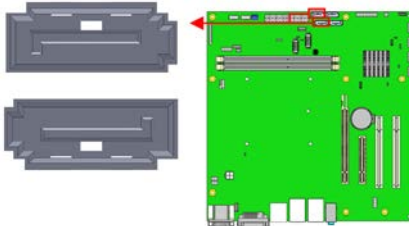
CN9, CN11: SATA2 Connectors**CN10, CN12: SATA2 or SATA3 Connectors**

MB961 supports SATA2 (3Gbps)

MB961F supports SATA2 (3Gbps) and SATA3 (6Gbps)

CH1, CH2: LVDS Connectors (1st channel, 2nd channel)
 (For MB961F/MB961RF only)

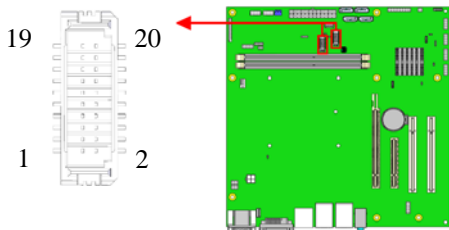

Signal Name	Pin #	Pin #	Signal Name
TX0-	2	1	TX0+
Ground	4	3	Ground
TX1-	6	5	TX1+
+5V/3.3V	8	7	Ground
TX3-	10	9	TX3+
TX2-	12	11	TX2+
Ground	14	13	Ground
TXC-	16	15	TXC+
+5V/3.3V	18	17	ENABKL
NC	20	19	NC

J1: MCU JTAG (for debug use)

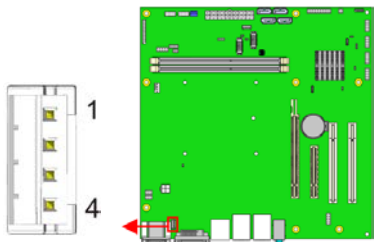

J3: Audio Pin Header for Chassis Front Panel

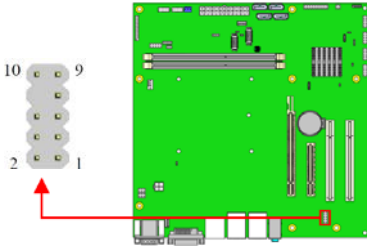

Signal Name	Pin #	Pin #	Signal Name
MIC IN_L	1	2	Ground
MIC IN_R	3	4	DET
LINE_R	5	6	Ground
Sense	7	8	KEY
LINE_L	9	10	Ground

J4: ATX 12V Power Connector

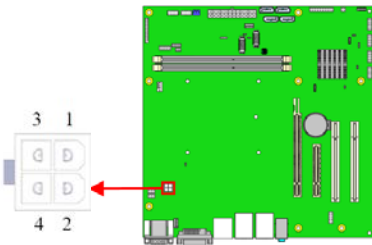

Pin #	Signal Name
1	Ground
2	Ground
3	+12V
4	+12V

J5, J9, J12, J14: USB Connectors

(J12 is supported by MB961RF only)

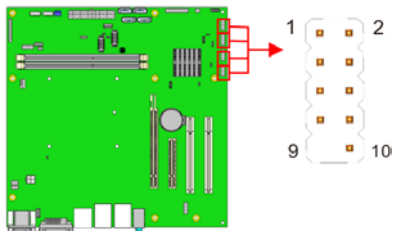

Signal Name	Pin #	Pin #	Signal Name
VCC	1	2	VCC
D0-	3	4	D1-
D0+	5	6	D1+
GND	7	8	GND
KEY	9	10	NC

J6, J8, DDR3 DIMM Sockets

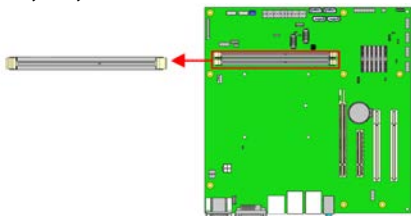

J10: Digital I/O

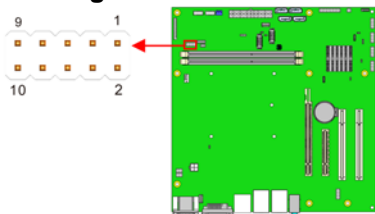

Signal Name	Pin #	Pin #	Signal Name
GND	1	2	VCC
OUT3	3	4	OUT1
OUT2	5	6	OUT0
IN3	7	8	IN1
IN2	9	10	IN0

J11: LPC Connector (for debug use)

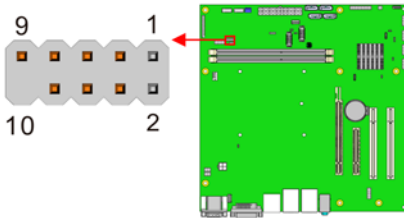

J13: Parallel Port Connector (*MB961 only*)

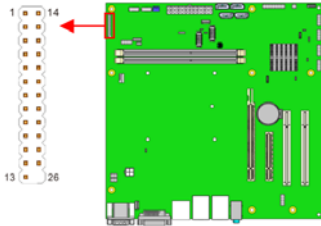

Signal Name	Pin #	Pin #	Signal Name
Line printer strobe	1	14	Auto Feed
PD0, parallel data 0	2	15	Error
PD1, parallel data 1	3	16	Initialize
PD2, parallel data 2	4	17	Select
PD3, parallel data 3	5	18	Ground
PD4, parallel data 4	6	19	Ground
PD5, parallel data 5	7	20	Ground
PD6, parallel data 6	8	21	Ground
PD7, parallel data 7	9	22	Ground
ACK, acknowledge	10	23	Ground
Busy	11	24	Ground
Paper empty	12	25	Ground
Select	13	26	N/A

J16, J17: COM3, COM4 RS232 Serial Ports

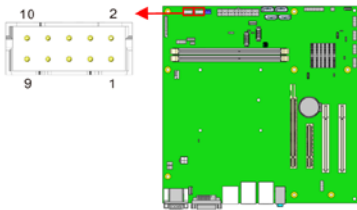

Signal Name	Pin #	Pin #	Signal Name
DCD, Data carrier detect	1	2	RXD, Receive data
TXD, Transmit data	3	4	DTR, Data terminal ready
GND, ground	5	6	DSR, Data set ready
RTS, Request to send	7	8	CTS, Clear to send
RI, Ring indicator	9	10	Not Used

J15: 24-pin ATX Power Connector

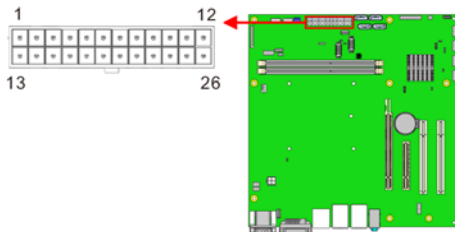

Signal Name	Pin #	Pin #	Signal Name
3.3V	13	1	3.3V
-12V	14	2	3.3V
Ground	15	3	Ground
PS-ON	16	4	+5V
Ground	17	5	Ground
Ground	18	6	+5V
Ground	19	7	Ground
-5V	20	8	Power good
+5V	21	9	5VSB
+5V	22	10	+12V
+5V	23	11	+12V
Ground	24	12	+3.3V

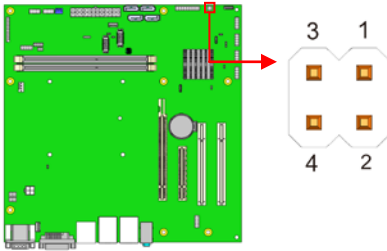
J18: ACPI LED Connector (MB961 only)

Pin #	Signal Name
1	S1/S3 LED+
2	Ground
3	S0 LED+
4	Ground

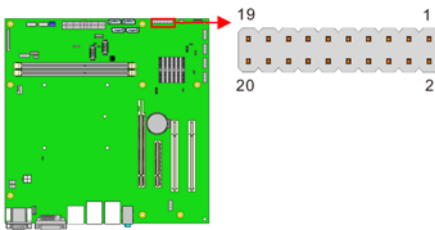
J19: Front Panel Function Connector

Signal Name	Pin #	Pin #	Signal Name
SPK -	1	2	PWR LED +
NC	3	4	NC
GND	5	6	PWR LED- (GND)
SPK +(+5V)	7	8	NC
NC	9	10	GND
NC	11	12	GND
PWR_SW	13	14	PWR_SW
NC	15	16	NC
RST+	17	18	RST-(GND)
HDD LED -	19	20	HDD LED +

J20: SPI Connector (For debug use)

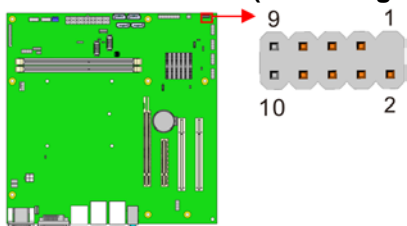

J21: LPC signal connector

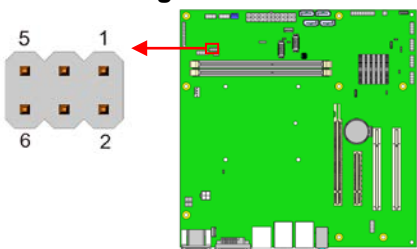

Signal Name	Pin	Pin	Signal Name
-SUSTAT	1	2	3VDUAL
SERIRQ	3	4	NC
GPIO	5	6	Ground

CPU_FAN1: CPU Fan Power Connector

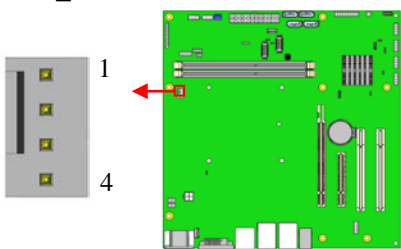

Pin #	Signal Name
1	Ground
2	+12V
3	Rotation detection
4	Control

SYS_FAN1: System Fan1 Power Connector

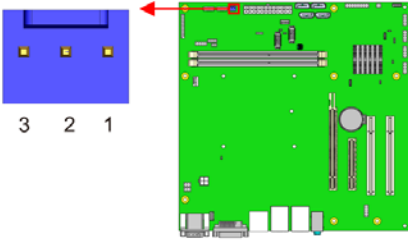

Pin #	Signal Name
1	Ground
2	+12V(MAX. 500mA)
3	Rotation detection

PCIE1: PCIE x8 Slot

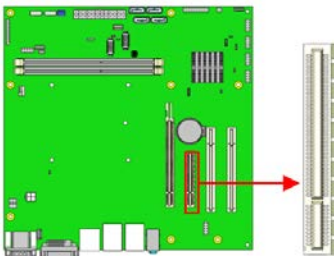

*MB961/MB961F support PCIE x1 only
 MB961RF supports PCIE x1 or PCIE x4*

PCIE2: PCI-E X16 Slot

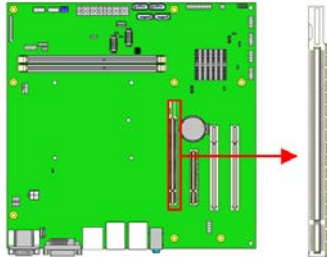

PCI3, PCI4: PCI Slot

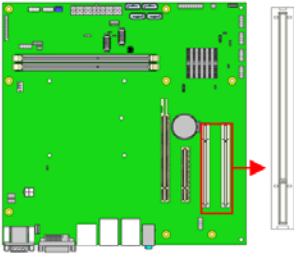

BIOS Setup

This chapter describes the different settings available in the AMI BIOS that comes with the board. The topics covered in this chapter are as follows:

BIOS Introduction.....	30
BIOS Setup.....	30
Advanced Settings	32
Chipset Settings.....	43
Boot Settings	49
CSM parameters	50
Security Settings.....	51
Save & Exit Settings.....	52

BIOS Introduction

The BIOS (Basic Input/Output System) installed in your computer system's ROM supports Intel processors. The BIOS provides critical low-level support for a standard device such as disk drives, serial ports and parallel ports. It also provides password protection as well as special support for detailed fine-tuning of the chipset controlling the entire system.

BIOS Setup

The BIOS provides a Setup utility program for specifying the system configurations and settings. The BIOS ROM of the system stores the Setup utility. When you turn on the computer, the BIOS is immediately activated. Pressing the key immediately allows you to enter the Setup utility. If you are a little bit late pressing the key, POST (Power On Self Test) will continue with its test routines, thus preventing you from invoking the Setup. If you still wish to enter Setup, restart the system by pressing the "Reset" button or simultaneously pressing the <Ctrl>, <Alt> and <Delete> keys. You can also restart by turning the system Off and back On again. The following message will appear on the screen:

```
Press <DEL> to Enter Setup
```

In general, you press the arrow keys to highlight items, <Enter> to select, the <PgUp> and <PgDn> keys to change entries, <F1> for help and <Esc> to quit.

When you enter the Setup utility, the Main Menu screen will appear on the screen. The Main Menu allows you to select from various setup functions and exit choices.

Warning: *It is strongly recommended that you avoid making any changes to the chipset defaults. These defaults have been carefully chosen by both AMI and your system manufacturer to provide the absolute maximum performance and reliability. Changing the defaults could cause the system to become unstable and crash in some cases.*

Main Settings

Aptio Setup Utility – Copyright © 2011 American Megatrends, Inc.

Main	Advanced	Chipset	Boot	Security	Save & Exit
BIOS Information				Choose the system default language	
System Language			[English]	→ ← Select Screen	
System Date			[Tue 01/20/2009]	↑ ↓ Select Item	
Access Level			Administrator	Enter: Select	
				+- Change Field	
				F1: General Help	
				F2: Previous Values	
				F3: Optimized Default	
				F4: Save ESC: Exit	

System Language

Choose the system default language.

System Date

Set the Date. Use Tab to switch between Data elements.

System Time

Set the Time. Use Tab to switch between Data elements.

Advanced Settings

This section allows you to configure and improve your system and allows you to set up some system features according to your preference.

Aptio Setup Utility					
Main	Advanced	Chipset	Boot	Security	Save & Exit
<ul style="list-style-type: none"> ▶ PCI Subsystem Settings ▶ ACPI Settings ▶ Wake up event setting ▶ Trusted Computing ▶ CPU Configuration ▶ SATA Configuration ▶ Shutdown Temperature Configuration ▶ iSmart Controller ▶ USB Configuration ▶ F81866 Super IO Configuration ▶ F81866 H/W Monitor ▶ CPU PPM Configuration 					<p>→ ← Select Screen ↑ ↓ Select Item Enter: Select +- Change Field F1: General Help F2: Previous Values F3: Optimized Default F4: Save ESC: Exit</p>

PCI Subsystem Settings

Aptio Setup Utility					
Main	Advanced	Chipset	Boot	Security	Save & Exit
PCI Bus Driver Version		V 2.0502			
PCI 64bit Resources Handling					
Above 4G Decoding		Disabled			
PCI Common Settings					
PCI Latency Timer		32 PCI Bus Clocks			
VGA Palette Snoop		Disabled			
PERR# Generation		Disabled			
SERR# Generation		Disabled			
▶ PCI Express Settings					
					<p>→ ← Select Screen ↑ ↓ Select Item Enter: Select +- Change Field F1: General Help F2: Previous Values F3: Optimized Default F4: Save ESC: Exit</p>

Above 4G Decoding

Enables or Disables 64bit capable devices to be decoded in above 4G address space (only if system supports 64 bit PCI decoding).

PCI Latency Timer

Value to be programmed into PCI Latency Timer Register.

VGA Palette Snoop

Enables or disables VGA Palette Registers Snooping.

PERR# Generation

Enables or disables PCI device to generate PERR#.

SERR# Generation

Enables or disables PCI device to generate SERR#.

PCI Express Settings

Change PCI Express devices settings.

PCI Express Settings

Aptio Setup Utility					
Main	Advanced	Chipset	Boot	Security	Save & Exit
PCI Express Device Register Settings					
	Relaxed Ordering		Disabled		
	Extended Tag		Disabled		
	No Snoop		Enabled		
	Maximum Payload		Auto		→ ← Select Screen
	Maximum Read Request		Auto		↑ ↓ Select Item
PCI Express Link Register Settings					
	ASPM Support		Disabled		Enter: Select
	WARNING: Enabling ASPM may cause PCI-E devices to fail		Disabled		+ - Change Field
	Extended Synch		Disabled		F1: General Help
	Link Training Retry		5		F2: Previous Values
	Link Training Timeout (uS)		100		F3: Optimized Default
	Unpopulated Links		Keep Link ON		F4: Save ESC: Exit

Relaxed Ordering

Enables or disables PCI Express Device Relaxed Ordering.

Extended Tag

If ENABLED allows device to use 8-bit Tag field as a requester.

No Snoop

Enables or disables PCI Express Device No Snoop option.

Maximum Payload

Set Maximum Payload of PCI Express Device or allow System BIOS to select the value.

Maximum Read Request

Set Maximum Read Request Size of PCI Express Device or allow System BIOS to select the value.

ASPM Support

Set the ASPM Level: Force L0s – Force all links to L0s State:
AUTO – BIOS auto configure: DISABLE – Disables ASPM.

Extended Synch

If ENABLED allows generation of Extended Synchronization patterns.

Link Training Retry

Defines number of Retry Attempts software will take to retrain the link if previous training attempt was unsuccessful.

Link Training Timeout (uS)

Defines number of Microseconds software will wait before polling 'Link Training' bit in Link Status register. Value range from 10 to 1000 uS.

Unpopulated Links

In order to save power, software will disable unpopulated PCI Express links, if this option set to 'Disable Link'.

ACPI Settings

Aptio Setup Utility

Main	Advanced	Chipset	Boot	Security	Save & Exit
ACPI Settings					→ ← Select Screen
Enable Hibernation			Enabled		↑ ↓ Select Item
ACPI Sleep State			S1 (Suspend to R...)		Enter: Select
Lock Legacy Resources			Disabled		+ - Change Field
S3 Video Repost			Disabled		F1: General Help
					F2: Previous Values
					F3: Optimized Default
					F4: Save ESC: Exit

Enable Hibernation

Enables or Disables System ability to Hibernate (OS/S4 Sleep State). This option may be not effective with some OS.

ACPI Sleep State

Select ACPI sleep state the system will enter, when the SUSPEND button is pressed.

Lock Legacy Resources

Enabled or Disabled Lock of Legacy Resources.

S3 Video Repost

Enable or disable S3 Video Repost.

Wake up event settings

Aptio Setup Utility

Main	Advanced	Chipset	Boot	Security	Save & Exit
	Wake system with Fixed Time		Disabled		
	Wake up hour		0		
	Wake up minute		0		
	Wake up second		0		
	Wake on Ring		Enabled		→ ← Select Screen
	Wake on PCI PME		Enabled		↑ ↓ Select Item
	Wake on PCIE Wake Event		Enabled		Enter: Select
					+ - Change Field
					F1: General Help
					F2: Previous Values
					F3: Optimized Default
					F4: Save ESC: Exit

Wake system with Fixed Time

Enables or Disables System wake on alarm event. When enabled, System will wake on the hr::min:: sec specified.

Wake on PCIE PME Wake Event

The options are Disabled and Enabled.

CPU Configuration

This section shows the CPU configuration parameters.

Aptio Setup Utility					
Main	Advanced	Chipset	Boot	Security	Save & Exit
CPU Configuration					
Intel® Core™ i7-3770 CPU @ 3.40GHz					
Processor Stepping			306a8		
Microcode Revision			c		
Max CPU Speed			3400 MHz		
Min CPU Speed			1600 MHz		
CPU Speed			3400 MHz		
Processor Cores			4		
Intel HT Technology			Supported		
Intel VT-x Technology			Supported		
Intel SMX Technology			Supported		
64-bit			Supported		
Hyper-threading			Enabled		→ ← Select Screen
Active Processor Cores			All		↑ ↓ Select Item
Limit CPUID Maximum			Disabled		Enter: Select
Execute Disable Bit			Enabled		+ - Change Field
Intel Virtualization Technology			Disabled		F1: General Help
Hardware Prefetcher			Disabled		F2: Previous Values
Adjacent Cache Line Prefetch			Enabled		F3: Optimized Default
					F4: Save ESC: Exit

Hyper-threading

Enabled for Windows XP and Linux (OS optimized for Hyper-Threading Technology) and Disabled for other OS (OS not optimized for Hyper-Threading Technology). When Disabled, only one thread per enabled core is enabled.

Active Processor Cores

Number of cores to enable in each processor package.

Limit CPUID Maximum

Disabled for Windows XP.

Execute Disable Bit

XD can prevent certain classes of malicious buffer overflow attacks when combined with a supporting OS (Windows Server 2003 SP1, Windows XP SP2, SuSE Linux 9.2, Re33dHat Enterprise 3 Update 3.)

Intel Virtualization Technology

When enabled, a VMM can utilize the additional hardware capabilities provided by Vanderpool Technology.

Hardware Prefetcher

To turn on/off the Mid level Cache (L2) streamer Prefetcher.

Adjacent Cache Line Prefetch

To turn on/off prefetching of adjacent cache lines.

SATA Configuration

SATA Devices Configuration.

Aptio Setup Utility					
Main	Advanced	Chipset	Boot	Security	Save & Exit
SATA Controller(s)		Enabled			
SATA Mode Selection		IDE			
SATA Port0		Empty			
Software Preserve		Unknown			
SATA Port1		Empty			
Software Preserve		Unknown			
SATA Port2		Empty			
Software Preserve		Unknown			
SATA Port3		Empty			
Software Preserve		Unknown			
SATA Port4		Empty			
Software Preserve		Unknown			
SATA Port5		Empty			
Software Preserve		Unknown			

→ ← Select Screen
 ↑ ↓ Select Item
 Enter: Select
 +- Change Field
 F1: General Help
 F2: Previous Values
 F3: Optimized Default
 F4: Save ESC: Exit

SATA Controller(s)

Enable / Disable Serial ATA Controller.

SATA Mode Selection

- (1) IDE Mode.
- (2) AHCI Mode.
- (3) RAID Mode.

Shutdown Temperature Configuration

Aptio Setup Utility

Main	Advanced	Chipset	Boot	Security	Save & Exit
ACPI Shutdown Temperature			Disabled		→ ← Select Screen ↑ ↓ Select Item Enter: Select +- Change Field F1: General Help F2: Previous Values F3: Optimized Default F4: Save ESC: Exit

ACPI Shutdown Temperature

The default setting is Disabled.

iSmart Controller

Aptio Setup Utility

Main	Advanced	Chipset	Boot	Security	Save & Exit
iSmart Controller					→ ← Select Screen ↑ ↓ Select Item Enter: Select +- Change Field F1: General Help F2: Previous Values F3: Optimized Default F4: Save ESC: Exit
Power-On after Power failure		Disable			
Schedule Slot 1		None			
Schedule Slot 2		None			

iSmart Controller

Setup the power on time for the system.

Schedule Slot 1 / 2

Setup the hour/minute for system power on.

USB Configuration

Aptio Setup Utility

Main	Advanced	Chipset	Boot	Security	Save & Exit
USB Configuration					
USB Devices: 2 Hubs					
Legacy USB Support			Enabled		
USB3.0 Support			Enabled		
XHCI Hand-off			Enabled		→ ← Select Screen
EHCI Hand-off			Enabled		↑ ↓ Select Item
Port 60/64 Emulation			Enabled		Enter: Select
USB hardware delays and time-outs:					+ - Change Field
USB Transfer time-out			20 sec		F1: General Help
Device reset time-out			20 sec		F2: Previous Values
Device power-up delay			Auto		F3: Optimized Default
					F4: Save ESC: Exit

Legacy USB Support

Enables Legacy USB support.

AUTO option disables legacy support if no USB devices are connected.

DISABLE option will keep USB devices available only for EFI applications.

USB3.0 Support

Enable/Disable USB3.0 (XHCI) Controller support.

XHCI Hand-off

This is a workaround for Oses without XHCI hand-off support. The XHCI ownership change should be claimed by XHCI driver.

EHCI Hand-off

Enabled/Disabled. This is a workaround for OSES without EHCI hand-off support. The EHCI ownership change should be claimed by EHCI driver.

Port 64/60 Emulation

Enables I/O port 60h/64h emulation support. This should be enabled for the complete USB keyboard legacy support for non-USB aware OSES.

USB Transfer time-out

The time-out value for Control, Bulk, and Interrupt transfers.

Device reset time-out

USB mass Storage device start Unit command time-out.

Device power-up delay

Maximum time the device will take before it properly reports itself to the Host Controller. ‘Auto’ uses default value: for a Root port it is 100ms, for a Hub port the delay is taken from Hub descriptor.

F81866 Super IO Configuration

Aptio Setup Utility

Main	Advanced	Chipset	Boot	Security	Save & Exit
Super IO Configuration					
F81866 Super IO Chip			F81866		→ ← Select Screen
▶ Serial Port 0 Configuration					↑ ↓ Select Item
▶ Serial Port 1 Configuration					Enter: Select
▶ Serial Port 2 Configuration					+ - Change Field
▶ Serial Port 3 Configuration					F1: General Help
▶ Parallel Port Configuration					F2: Previous Values
					F3: Optimized Default
					F4: Save ESC: Exit

Serial Port Configuration

Set Parameters of Serial Ports. User can Enable/Disable the serial port and Select an optimal settings for the Super IO Device.

Parallel Port Configuration

Set Parameters of Parallel Port(LPT/LPTE)

F81866 H/W Monitor

Aptio Setup Utility

Main	Advanced	Chipset	Boot	Security	Save & Exit
PC Health Status					
CPU temperature			+41 C		
SYS temperature			+35 C		
FAN1 Speed			4021RPM		
FAN2 Speed			N/A		
Vcore			+0.976V		
+5V			+5.213 V		
+12V			+12.408 V		→ ← Select Screen
1.5V			+1.504 V		↑ ↓ Select Item
VSB5V			+4.992 V		Enter: Select
VCC3V			+3.392 V		+ - Change Field
Fan1 smart fan control					F1: General Help
Fan2 smart fan control					F2: Previous Values
					F3: Optimized Default
					F4: Save ESC: Exit

Temperatures/Voltages

These fields are the parameters of the hardware monitoring function feature of the motherboard. The values are read-only values as monitored by the system and show the PC health status.

Fan1/Fan2 Smart Fan Control

This field enables or disables the smart fan feature. At a certain temperature, the fan starts turning. Once the temperature drops to a certain level, it stops turning again.

CPU PPM Configuration

Aptio Setup Utility

Main	Advanced	Chipset	Boot	Security	Save & Exit
CPU PPM Configuration					
EIST			Enabled		→ ← Select Screen ↑ ↓ Select Item Enter: Select +- Change Field F1: General Help F2: Previous Values F3: Optimized Default F4: Save ESC: Exit
Turbo Mode			Enabled		

EIST

Enable/Disable Intel SpeedStep.

Chipset Settings

This section allows you to configure and improve your system and allows you to set up some system features according to your preference.

Aptio Setup Utility

Main	Advanced	Chipset	Boot	Security	Save & Exit
<ul style="list-style-type: none"> ▶ PCH-IO Configuration ▶ System Agent (SA) Configuration 					→ ← Select Screen ↑ ↓ Select Item Enter: Select +- Change Field F1: General Help F2: Previous Values F3: Optimized Default F4: Save ESC: Exit

PCH-IO Configuration

This section allows you to configure the North Bridge Chipset.

Aptio Setup Utility					
Main	Advanced	Chipset	Boot	Security	Save & Exit
		Intel PCH RC Version	1.5.0.0		
		Intel PCH SKU Name	H61		
		Intel PCH Rev ID	O5/B3		
		▶ PCI Express Configuration			
		▶ USB Configuration			
		▶ PCH Azalia Configuration			
		PCH LAN Controller	Enabled		
		Wake on LAN	Enabled		
		High Precision Event Timer Configuration			
		High Precision Timer	Enabled		→ ← Select Screen
		SLP_S4 Assertion Width	4-5 Seconds		↑ ↓ Select Item
					Enter: Select
					+ - Change Field
					F1: General Help
					F2: Previous Values
					F3: Optimized Default
					F4: Save ESC: Exit

PCH LAN Controller

Enable or disable onboard NIC.

Wake on LAN

Enable or disable integrated LAN to wake the system. (The Wake On LAN cannot be disabled if ME is on at Sx state.)

SLP_S4 Assertion Width

Select a minimum assertion width of the SLP_S4# signal.

PCI Express Configuration

Main	Advanced	Chipset	Boot	Security	Save & Exit
PCI Express Configuration					
PCI Express Clock Gating			Enabled		
DMI Link ASPM Control			Enabled		
DMI Link Extended Synch Control			Disabled		
PCIe-USB Glitch W/A			Disabled		
Subtractive Decode			Disabled		
<ul style="list-style-type: none"> ▶ PCI Express Root Port 1 ▶ PCI Express Root Port 2 ▶ PCI Express Root Port 3 <ul style="list-style-type: none"> PCI-E Port 4 is assigned to LAN ▶ PCI Express Root Port 5 ▶ PCI Express Root Port 6 ▶ PCI Express Root Port 7 ▶ PCI Express Root Port 8 					
					→ ← Select Screen ↑ ↓ Select Item Enter: Select +- Change Field F1: General Help F2: Previous Values F3: Optimized Default F4: Save ESC: Exit

PCI Express Clock Gating

Enable or disable PCI Express Clock Gating for each root port.

DMI Link ASPM Control

The control of Active State Power Management on both NB side and SB side of the DMI link.

PCIe-USB Glitch W/A

PCIe-USB Glitch W/A for bad USB device(s) connected behind PCI/PEG port.

USB Configuration

Main	Advanced	Chipset	Boot	Security	Save & Exit
USB Configuration					
EHCI1			Enabled		
EHCI2			Enabled		
USB Ports Per-Port Disable Control			Disabled		
					→ ← Select Screen ↑ ↓ Select Item Enter: Select +- Change Field F1: General Help F2: Previous Values F3: Optimized Default F4: Save ESC: Exit

EHCI1/2

Control the USAB EHCI (USB 2.0) functions. One EHCI controller must always be enabled.

USB Ports Per-Port Disable Control

Control each of the USB ports (0~13) disabling.

PCH Azalia Configuration

Main	Advanced	Chipset	Boot	Security	Save & Exit
PCH Azalia Configuration					
Azalia			Auto		
Azalia Docking Support			Disabled		
Azalia PME			Disabled		
Azalia Internal HDMI Code			Disabled		
					→ ← Select Screen ↑ ↓ Select Item Enter: Select +- Change Field F1: General Help F2: Previous Values F3: Optimized Default F4: Save ESC: Exit

Azalia

Control Detection of the Azalia device.

Disabled = Azalia will unconditionally disabled.

Enabled Azalia will be unconditionally enabled.

Auto = Azalia will enabled if present, disabled otherwise.

System Agent (SA) Configuration

Aptio Setup Utility

Main	Advanced	Chipset	Boot	Security	Save & Exit
		System Agent Bridge Name	IvyBridge		
		System Agent RC Version	1.1.0.0		
		VT-d Capability	Supported		
		VT-d	Enabled		
		CHAP Device (B0:D7:F0)	Disabled		→ ← Select Screen
		Thermal Device (B0:D4:F0)	Disabled		↑ ↓ Select Item
		Enable NB CRID	Disabled		Enter: Select
		BDAT ACPI Table Support	Disabled		+ - Change Field
		C-State Pre-Wake	Enabled		F1: General Help
		▶ Graphics Configuration			F2: Previous Values
		▶ Memory Configuration			F3: Optimized Default
					F4: Save ESC: Exit

VT-d

Check to enable VT-d function on MCH.

Enable NB CRID

Enable or disable NB CRID WorkAround.

C-State Pre-Wake

Controls C-State Pre-Wake feature for ARAT, in SSKPD[57].

Graphics Configuration

Aptio Setup Utility

Main	Advanced	Chipset	Boot	Security	Save & Exit
		Graphics Configuration			
		IGFX VBIOS Version	2132		
		IGfx Frequency	350 MHz		
		Primary Display	Auto		
		Internal Graphics	Auto		→ ← Select Screen
		GTT Size	2MB		↑ ↓ Select Item
		Aperture Size	256MB		Enter: Select
		DVMT Pre-Allocated	64M		+ - Change Field
		DVMT Total Gfx Mode	Disabled		F1: General Help
		Gfx Low Power Mode	Disabled		F2: Previous Values
		▶ LCD Control			F3: Optimized Default
					F4: Save ESC: Exit

Primary Display

Select which of IGFX/PEG/PCI graphics device should be primary display or select SG for switchable Gfx.

Internal Graphics

Keep IGD enabled based on the setup options.

DVMT Pre-Allocated

Select DVMT 5.0 Pre-Allocated (Fixed) graphics memory size used by the internal graphics device.

DVMT Total Gfx Mem

Select DVMT 5.0 total graphics memory size used by the internal graphics device.

Gfx Low Power Mode

This option is applicable for SFF only.

Primary IGFX Boot Display (LCD Control)

Select the Video Device that will be activated during POST. This has no effect if external graphics present. Secondary boot display selection will appear based on your selection. VGA modes will be supported only on primary display.

Memory Configuration

Aptio Setup Utility

Main	Advanced	Chipset	Boot	Security	Save & Exit
Memory Information					
Memory Frequency			1333 MHz		
Total Memory			8192 MB (DDR3)		
DIMM#0			2048 MB (DDR3)		
DIMM#1			Not Present	→ ← Select Screen	
DIMM#2			2048 MB (DDR3)	↑ ↓ Select Item	
DIMM#3			Not Present	Enter: Select	
CAS Latency (tCL)			11	+- Change Field	
Minimum delay time					
CAS to RAS (tRCDmin)			11	F1: General Help	
Row Precharge (tRPmin)			11	F2: Previous Values	
Active to Precharge (tRASmin)			28	F3: Optimized Default	
				F4: Save ESC: Exit	

Boot Settings

This section allows you to configure the boot settings.

Aptio Setup Utility					
Main	Advanced	Chipset	Boot	Security	Save & Exit
Boot Configuration					
Setup Prompt Timeout			1		
Bootup NumLock State			On		
Quiet Boot			Disabled		
Fast Boot			Disabled		
CSM16 Module Version			07.68		→ ← Select Screen
GateA20 Active			Upon Request		↑ ↓ Select Item
Option ROM Messages			Force BIOS		Enter: Select
INT19 Trap Response			Immediate		+ - Change Field
Boot Option Priorities					F1: General Help
▶ CSM parameters					F2: Previous Values
					F3: Optimized Default
					F4: Save ESC: Exit

Setup Prompt Timeout

Number of seconds to wait for setup activation key.
65535(0xFFFF) means indefinite waiting.

Bootup NumLock State

Select the keyboard NumLock state.

Quiet Boot

Enables/Disables Quiet Boot option.

Fast Boot

Enables/Disables boot with initialization of a minimal set of devices required to launch active boot option. Has no effect for BBS boot options.

GateA20 Active

UPON REQUEST – GA20 can be disabled using BIOS services.
ALWAYS – do not allow disabling GA20; this option is useful when any RT code is executed above 1MB.

Option ROM Messages

Set display mode for Option ROM. Options are Force BIOS and Keep Current.

INT19 Trap Response

Enable: Allows Option ROMs to trap Int 19.

Boot Option Priorities

Sets the system boot order.

CSM parameters

This section allows you to configure the boot settings.

Aptio Setup Utility					
Main	Advanced	Chipset	Boot	Security	Save & Exit
Launch CSM			Always		
Boot option filter			UEFI and Legacy		
Launch PXE OpROM policy			Do not launch		
Launch Storage OpROM policy			Legacy only		
Launch Video OpROM policy			Legacy only		
Other PCI device ROM priority			Legacy OpROM		
					→ ← Select Screen ↑ ↓ Select Item Enter: Select +- Change Field F1: General Help F2: Previous Values F3: Optimized Default F4: Save ESC: Exit

Boot option filter

This option controls what devices system can boot to.

Launch PXE OpROM policy

Controls the execution of UEFI and Legacy PXE OpROM.

Launch Storage OpROM policy

Controls the execution of UEFI and Legacy Storage OpROM.

Launch Video OpROM policy

Controls the execution of UEFI and Legacy Video OpROM.

Other PCI device ROM priority

For PCI devices other than Network, Mass storage or Video defines which OpROM to launch.

Security Settings

This section allows you to configure and improve your system and allows you to set up some system features according to your preference.

Aptio Setup Utility					
Main	Advanced	Chipset	Boot	Security	Save & Exit
Password Description					
If ONLY the Administrator's password is set, then this only limit access to Setup and is only asked for when entering Setup.					
If ONLY the User's password is set, then this is a power on password and must be entered to boot or enter Setup. In Setup the User will have Administrator rights					
The password length must be in the following range:					
Minimum length				3	
Maximum length				20	
Administrator Password					
User Password					
					→ ← Select Screen ↑ ↓ Select Item Enter: Select +- Change Field F1: General Help F2: Previous Values F3: Optimized Default F4: Save ESC: Exit

Administrator Password

Set Setup Administrator Password.

User Password

Set User Password.

Save & Exit Settings

Aptio Setup Utility					
Main	Advanced	Chipset	Boot	Security	Save & Exit
Save Changes and Exit Discard Changes and Exit Save Changes and Reset Discard Changes and Reset Save Options Save Changes Discard Changes Restore Defaults Save as User Defaults Restore User Defaults					→ ← Select Screen ↑ ↓ Select Item Enter: Select +- Change Field F1: General Help F2: Previous Values F3: Optimized Default F4: Save ESC: Exit

Save Changes and Exit

Exit system setup after saving the changes.

Discard Changes and Exit

Exit system setup without saving any changes.

Save Changes and Reset

Reset the system after saving the changes.

Discard Changes and Reset

Reset system setup without saving any changes.

Save Changes

Save Changes done so far to any of the setup options.

Discard Changes

Discard Changes done so far to any of the setup options.

Restore Defaults

Restore/Load Defaults values for all the setup options.

Save as User Defaults

Save the changes done so far as User Defaults.

Restore User Defaults

Restore the User Defaults to all the setup options.

Drivers Installation

This section describes the installation procedures for software and drivers. The software and drivers are included with the motherboard. If you find the items missing, please contact the vendor where you made the purchase. The contents of this section include the following:

Intel Chipset Software Installation Utility	54
VGA Drivers Installation	56
Realtek HD Audio Driver Installation	58
LAN Drivers Installation	59
Realtek LAN Controller Drivers Installation	61
Intel® Management Engine Interface	64
ASMedia USB 3.0 Drivers.....	67

IMPORTANT NOTE:

After installing your Windows operating system, you must install first the Intel Chipset Software Installation Utility before proceeding with the drivers installation.

Intel Chipset Software Installation Utility

The Intel Chipset Drivers should be installed first before the software drivers to enable Plug & Play INF support for Intel chipset components. Follow the instructions below to complete the installation.

1. Insert the CD that comes with the board. Click **Intel** and then **Intel(R) 7 Series Chipset Drivers**.



2. Click **Intel(R) Chipset Software Installation Utility**.



- When the Welcome screen to the Intel® Chipset Device Software appears, click **Next** to continue.



- Click **Yes** to accept the software license agreement and proceed with the installation process.



- On the Readme File Information screen, click **Next** to continue the installation.



- The Setup process is now complete. Click **Finish** to restart the computer and for changes to take effect.



VGA Drivers Installation

NOTE: Before installing the *Intel(R) Q77 Chipset Family Graphics Driver*, the Microsoft .NET Framework 3.5 SPI should be first installed.

To install the VGA drivers, follow the steps below.

1. Insert the CD that comes with the board. Click *Intel* and then *Intel(R) 7 Series Chipset Drivers*.



2. Click *Intel(R) Q77 Chipset Family Graphics Driver*.

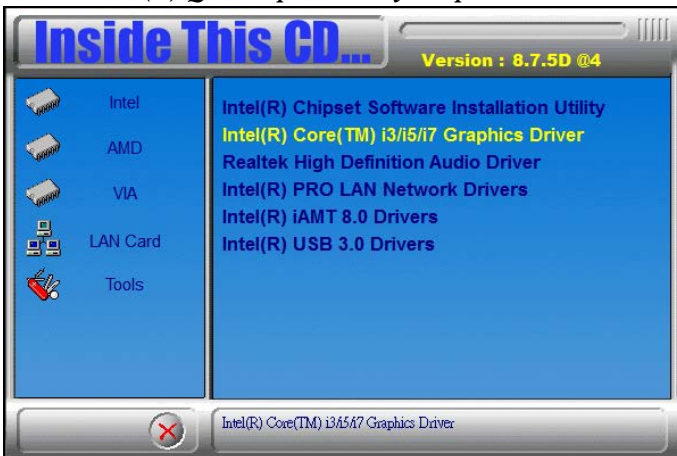

3. When the Welcome screen appears, click *Next* to continue.



4. Click *Yes* to agree with the license agreement and continue the installation.



5. On the Readme File Information screen, click *Next* to continue the installation of the Intel® Graphics Media Accelerator Driver.



6. On Setup Progress screen, click *Next* to continue.



7. Setup complete. Click *Finish* to restart the computer and for changes to take effect.

Realtek HD Audio Driver Installation

Follow the steps below to install the Realtek HD Audio Drivers.

1. Insert the CD that comes with the board. Click **Intel** and then **Intel(R) 7 Series Chipset Drivers**.



2. Click **Realtek High Definition Audio Driver**.



3. On the Welcome to the InstallShield Wizard screen, click **Next** to proceed with and complete the installation process.

4. The InstallShield Wizard Complete. Click **Finish** to restart the computer and for changes to take effect.

LAN Drivers Installation

1. Insert the CD that comes with the board. Click **Intel** and then **Intel(R) 7 Series Chipset Drivers**.



2. Click **Intel(R) PRO LAN Network Driver**.



3. Click **Install Drivers and Software**.

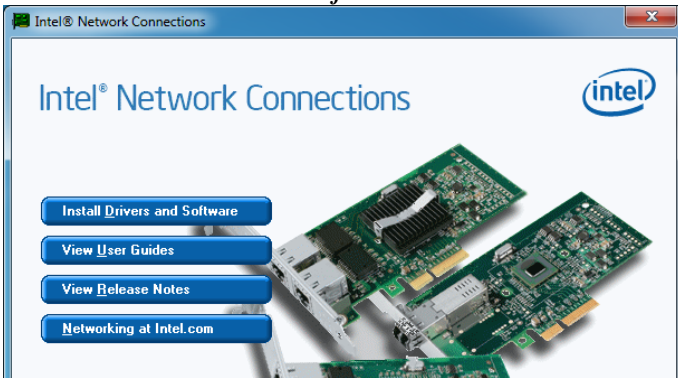

4. When the Welcome screen appears, click **Next**.

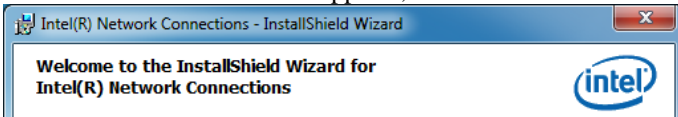

5. Click **Next** to agree with the license agreement.

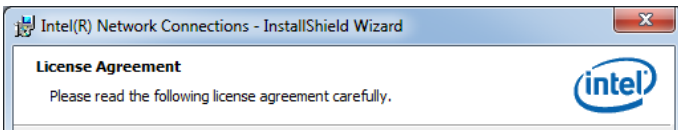

6. Click the checkbox for **Drivers** in the Setup Options screen to select it and click **Next** to continue.

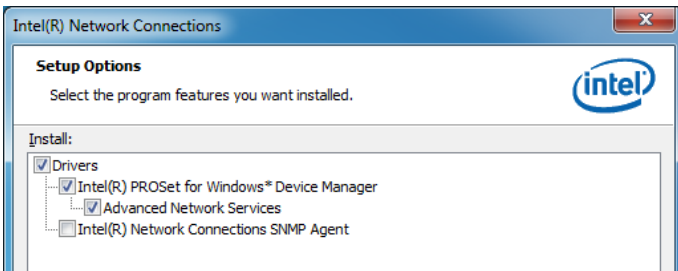

Realtek LAN Controller Drivers Installation

Follow the steps below to install the Realtek LAN Drivers.

1. Insert the CD that comes with the board. Click **Intel**, then **LAN Card**, and then **Realtek Lan Controller Drivers**.



2. Click **Realtek RTL8111E LAN Drivers**.



3. When the welcome screen to InstallShield Wizard appears, click *Next* to start the installation.

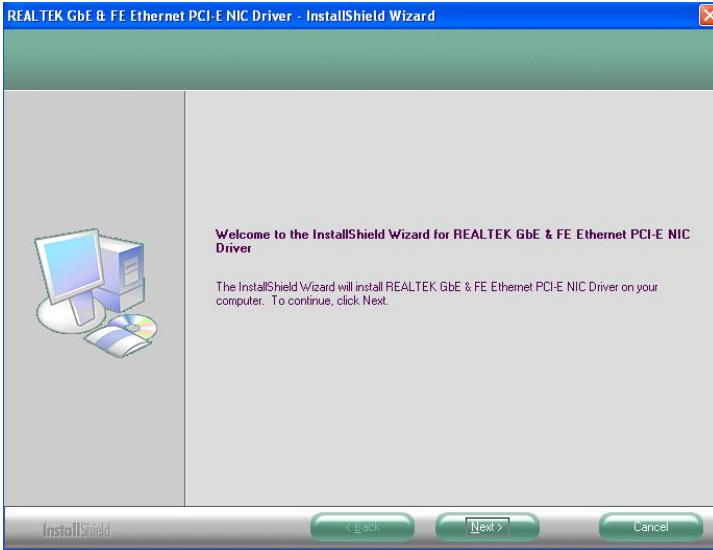

4. When the InstallShield Wizard has finished installing the Realtek LAN drivers, click *Finish*.

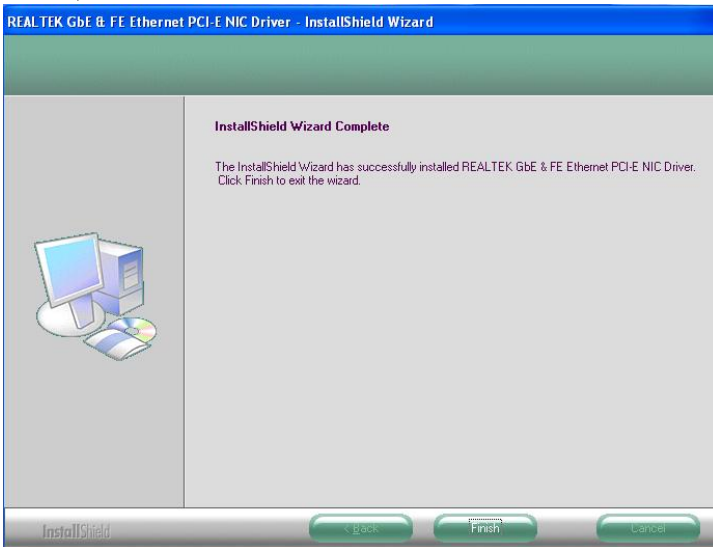

7. The wizard is ready to begin installation. Click **Install** to begin the installation.

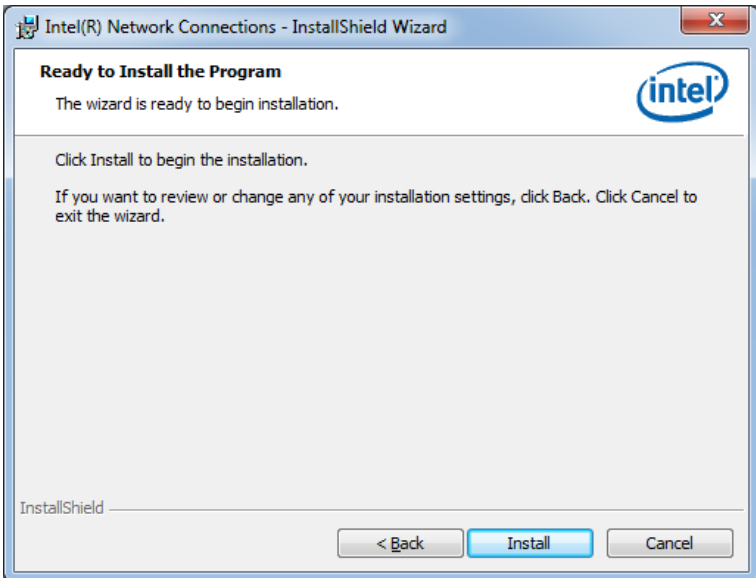

8. When InstallShield Wizard is complete, click **Finish**.

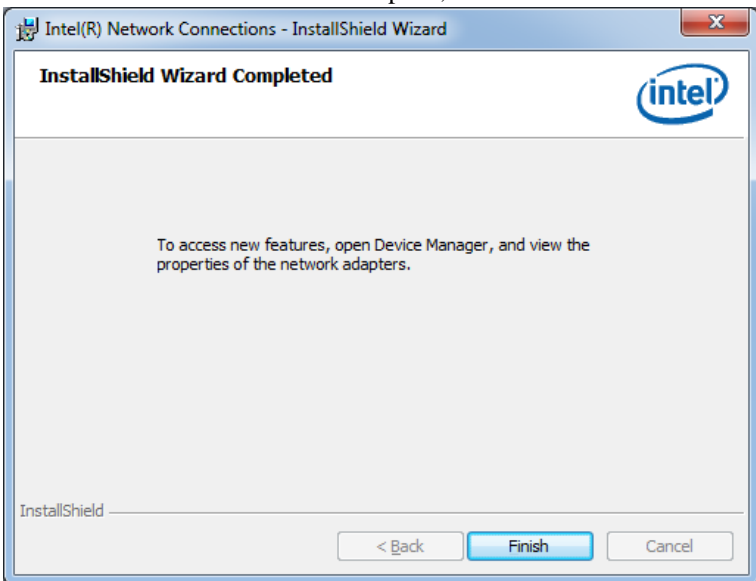

Intel® Management Engine Interface

Follow the steps below to install the Intel Management Engine.

1. Insert the CD that comes with the board. Click *Intel* and then *Intel(R) AMT 8.0 Drivers*.



2. When the Welcome screen to the InstallShield Wizard for Intel® Management Engine Components, click the checkbox for **Install Intel® Control Center** & click *Next*.



3. Click *Yes* to agree with the license agreement.

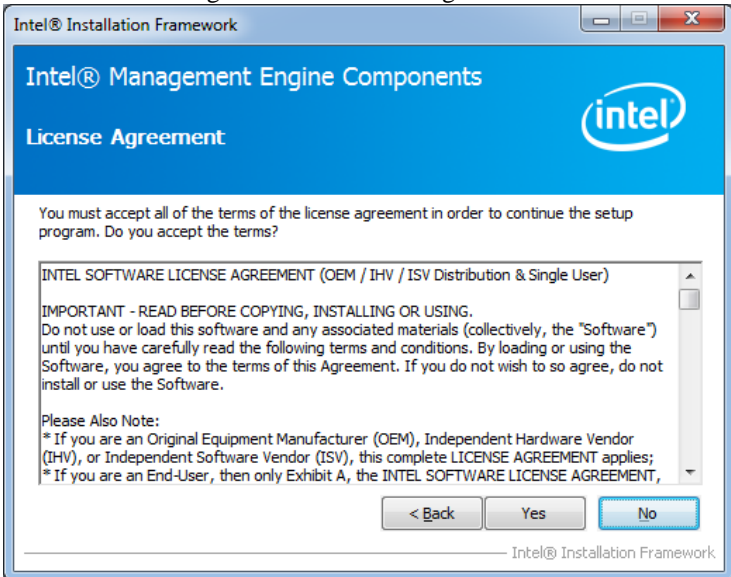

4. When the Setup Progress screen appears, click *Next*. Then, click *Finish* when the setup progress has been successfully installed.

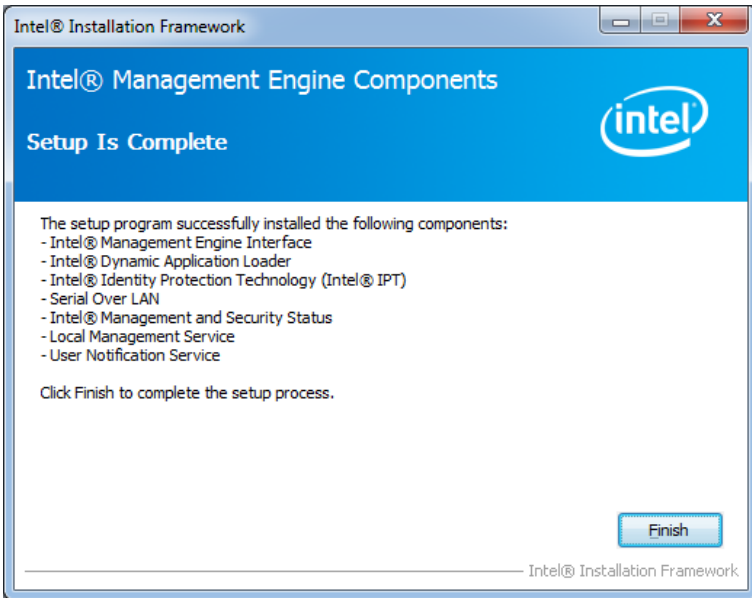
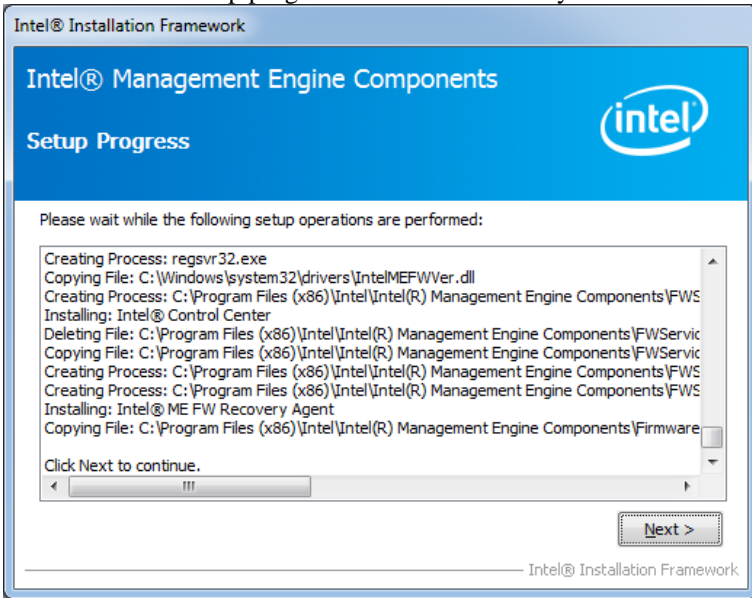

ASMedia USB 3.0 Drivers

1. Insert the CD that comes with the board. Click *Intel* and then *Intel(R) 6 Series Chipset Drivers*.

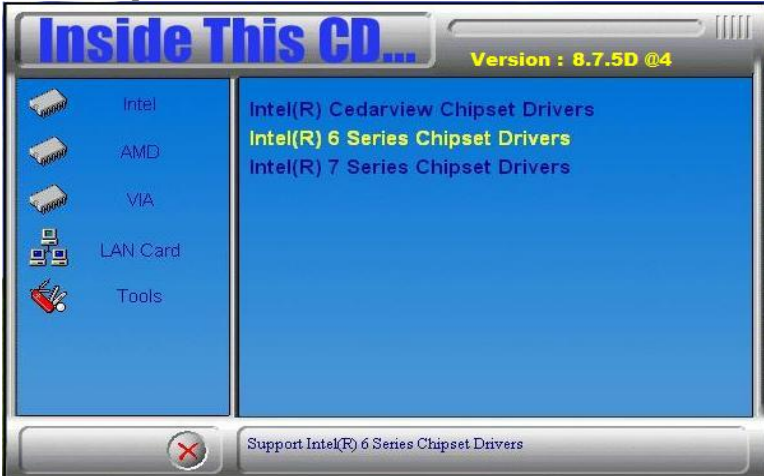

2. Click *Intel(R) PRO LAN Network Driver*.



2. When the Welcome screen to the InstallShield Wizard for Intel® Management Engine Components, click *Next*.

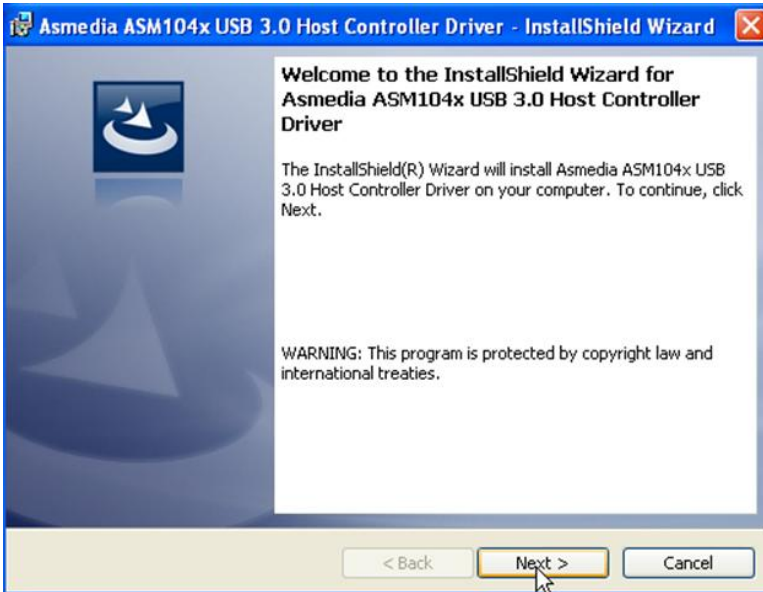

3. When InstallShield Wizard is complete, click *Finish*.

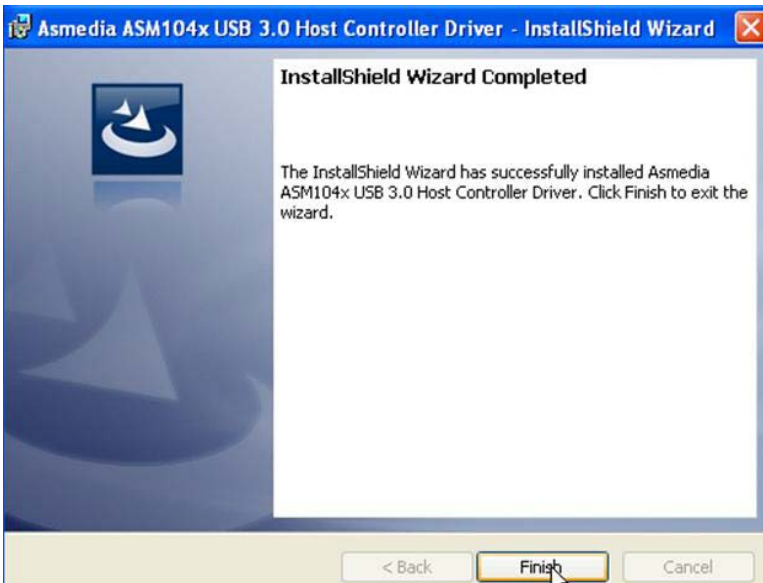

Appendix

A. I/O Port Address Map

Each peripheral device in the system is assigned a set of I/O port addresses which also becomes the identity of the device. The following table lists the I/O port addresses used.

Address	Device Description
000h - 01Fh	DMA Controller #1
020h - 03Fh	Interrupt Controller #1
040h - 05Fh	Timer
060h - 06Fh	Keyboard Controller
070h - 07Fh	Real Time Clock, NMI
080h - 09Fh	DMA Page Register
0A0h - 0BFh	Interrupt Controller #2
0C0h - 0DFh	DMA Controller #2
0F0h	Clear Math Coprocessor Busy Signal
0F1h	Reset Math Coprocessor
1F0h - 1F7h	IDE Interface
2E8h - 2EFh	Serial Port #4(COM4)
2F8h - 2FFh	Serial Port #2(COM2)
2B0h - 2DFh	Graphics adapter Controller
378h - 3FFh	Parallel Port #1(LPT1)
3E8h - 3EFh	Serial Port #3(COM3)
3F8h - 3FFh	Serial Port #1(COM1)

B. Interrupt Request Lines (IRQ)

Peripheral devices use interrupt request lines to notify CPU for the service required. The following table shows the IRQ used by the devices on board.

Level	Function
IRQ0	System Timer Output
IRQ1	Keyboard
IRQ3	Serial Port #2
IRQ4	Serial Port #1
IRQ5	Serial Port #3 & Serial Port #4 & Parallel Port #1
IRQ6	Reserved
IRQ7	Reserved
IRQ8	Real Time Clock
IRQ9	Microsoft ACPI-Compliant System
IRQ10	Intel(R)6 Series /C200 Series Chipset Family SMBus Controller-1C22
IRQ12	PS/2 Mouse

C. Watchdog Timer Configuration

The WDT is used to generate a variety of output signals after a user programmable count. The WDT is suitable for use in the prevention of system lock-up, such as when software becomes trapped in a deadlock. Under these sorts of circumstances, the timer will count to zero and the selected outputs will be driven. Under normal circumstance, the user will restart the WDT at regular intervals before the timer counts to zero.

SAMPLE CODE:

```
//-----
//
// THIS CODE AND INFORMATION IS PROVIDED "AS IS" WITHOUT WARRANTY OF ANY
// KIND, EITHER EXPRESSED OR IMPLIED, INCLUDING BUT NOT LIMITED TO THE
// IMPLIED WARRANTIES OF MERCHANTABILITY AND/OR FITNESS FOR A PARTICULAR
// PURPOSE.
//
//-----
#include <dos.h>
#include <conio.h>
#include <stdio.h>
#include <stdlib.h>
#include "F81866.H"
//-----
int main (int argc, char *argv[]);
void EnableWDT(int);
void DisableWDT(void);
//-----
int main (int argc, char *argv[])
{
    unsigned char bBuf;
    unsigned char bTime;
    char **endptr;

    char SIO;

    printf("Fintek 81866 watch dog program\n");

    SIO = Init_F81866();
    if (SIO == 0)
    {
        printf("Can not detect Fintek 81866, program abort.\n");
        return(1);
    }/if (SIO == 0)

    if (argc != 2)
    {
        printf(" Parameter incorrect!!\n");
        return (1);
    }

    bTime = strtol (argv[1], endptr, 10);
    printf("System will reset after %d seconds\n", bTime);

    if (bTime)
    {
        EnableWDT(bTime); }
    else
    {
        DisableWDT(); }

    return 0;
}
```

```

}
//-----
void EnableWDT(int interval)
{
    unsigned char bBuf;

    bBuf = Get_F81866_Reg(0x2B);
    bBuf &= (~0x20);
    Set_F81866_Reg(0x2B, bBuf); //Enable WDTO

    Set_F81866_LD(0x07); //switch to logic device 7
    Set_F81866_Reg(0x30, 0x01); //enable timer

    bBuf = Get_F81866_Reg(0xF5);
    bBuf &= (~0x0F);
    bBuf |= 0x52;
    Set_F81866_Reg(0xF5, bBuf); //count mode is second

    Set_F81866_Reg(0xF6, interval); //set timer

    bBuf = Get_F81866_Reg(0xFA);
    bBuf |= 0x01;
    Set_F81866_Reg(0xFA, bBuf); //enable WDTO output

    bBuf = Get_F81866_Reg(0xF5);
    bBuf |= 0x20;
    Set_F81866_Reg(0xF5, bBuf); //start counting
}
//-----
void DisableWDT(void)
{
    unsigned char bBuf;

    Set_F81866_LD(0x07); //switch to logic device 7

    bBuf = Get_F81866_Reg(0xFA);
    bBuf &= ~0x01;
    Set_F81866_Reg(0xFA, bBuf); //disable WDTO output

    bBuf = Get_F81866_Reg(0xF5);
    bBuf &= ~0x20;
    bBuf |= 0x40;
    Set_F81866_Reg(0xF5, bBuf); //disable WDT
}
//-----

```

```

//-----
//
// THIS CODE AND INFORMATION IS PROVIDED "AS IS" WITHOUT WARRANTY OF ANY
// KIND, EITHER EXPRESSED OR IMPLIED, INCLUDING BUT NOT LIMITED TO THE
// IMPLIED WARRANTIES OF MERCHANTABILITY AND/OR FITNESS FOR A PARTICULAR
// PURPOSE.
//
//-----
#include "F81866.H"
#include <dos.h>
//-----
unsigned int F81866_BASE;
void Unlock_F81866 (void);
void Lock_F81866 (void);
//-----
unsigned int Init_F81866(void)
{
    unsigned int result;
    unsigned char ucDid;

    F81866_BASE = 0x4E;
    result = F81866_BASE;

    ucDid = Get_F81866_Reg(0x20);
    if (ucDid == 0x07) //Fintek 81866
    {
        goto Init_Finish;
    }

    F81866_BASE = 0x2E;
    result = F81866_BASE;

    ucDid = Get_F81866_Reg(0x20);
    if (ucDid == 0x07) //Fintek 81866
    {
        goto Init_Finish;
    }

    F81866_BASE = 0x00;
    result = F81866_BASE;
}

Init_Finish:
    return (result);
}
//-----
void Unlock_F81866 (void)
{
    outportb(F81866_INDEX_PORT, F81866_UNLOCK);
    outportb(F81866_INDEX_PORT, F81866_UNLOCK);
}
//-----
void Lock_F81866 (void)
{
    outportb(F81866_INDEX_PORT, F81866_LOCK);
}
//-----
void Set_F81866_LD( unsigned char LD)
{
    Unlock_F81866();
    outportb(F81866_INDEX_PORT, F81866_REG_LD);
    outportb(F81866_DATA_PORT, LD);
    Lock_F81866();
}
//-----
void Set_F81866_Reg( unsigned char REG, unsigned char DATA)
{
    Unlock_F81866();
    outportb(F81866_INDEX_PORT, REG);
    outportb(F81866_DATA_PORT, DATA);
    Lock_F81866();
}
//-----

```

```

unsigned char Get_F81866_Reg(unsigned char REG)
{
    unsigned char Result;
    Unlock_F81866();
    outportb(F81866_INDEX_PORT, REG);
    Result = inportb(F81866_DATA_PORT);
    Lock_F81866();
    return Result;
}
//-----

//-----
//
// THIS CODE AND INFORMATION IS PROVIDED "AS IS" WITHOUT WARRANTY OF ANY
// KIND, EITHER EXPRESSED OR IMPLIED, INCLUDING BUT NOT LIMITED TO THE
// IMPLIED WARRANTIES OF MERCHANTABILITY AND/OR FITNESS FOR A PARTICULAR
// PURPOSE.
//
//-----
#ifndef __F81866_H
#define __F81866_H                1
//-----
#define F81866_INDEX_PORT        (F81866_BASE)
#define F81866_DATA_PORT        (F81866_BASE+1)
//-----
#define F81866_REG_LD            0x07
//-----
#define F81866_UNLOCK            0x87
#define F81866_LOCK              0xAA
//-----
unsigned int Init_F81866(void);
void Set_F81866_LD( unsigned char);
void Set_F81866_Reg( unsigned char, unsigned char);
unsigned char Get_F81866_Reg( unsigned char);
//-----
#endif __F81866_H

```