

ET839

**Intel® Atom™ E3800 series SoC Intel Atom
ETX CPU Module**

USER'S MANUAL

Version 1.0

Acknowledgments

AMI BIOS is a trademark of American Megatrends Inc.

PS/2 is a trademark of International Business Machines Corporation.

Intel and Atom are registered trademarks of Intel Corporation.

Microsoft Windows is a registered trademark of Microsoft Corporation.

Nuvoton is a registered trademark of Winbond Electronics Corporation.

All other product names or trademarks are properties of their respective owners.

PS/2 is a trademark of International Business Machines Corporation.

Table of Contents

Introduction	1
Product Description.....	1
Checklist.....	2
ET839 Specifications	3
Board Dimensions	4
Installations	5
Installing the Memory	6
Connector Pin Assignments	7
Setting the Jumpers	12
BIOS Setup.....	13
Drivers Installation	25
Intel Chipset Software Installation Utility	26
VGA Drivers Installation	27
Realtek High Definition Audio Driver Installation.....	28
Intel Trusted Execution Engine Installation.....	29
LAN Drivers Installation.....	30
Appendix.....	31
A. I/O Port Address Map	31
B. Interrupt Request Lines (IRQ).....	32
C. Watchdog Timer Configuration	錯誤! 尚未定義書籤。

This page is intentionally left blank.

Introduction

Product Description

The ET839 is an ETX CPU module based computer that is configured with the Intel® Atom™ E3800 series processors.

The ET839 has a SO-DIMM socket that supports up to 4GB of DDR3L (1.35V) memory. The on board AMI BIOS facilitates easy system configuration and peripheral setup. Other features include SATA ports, two RS232 serial ports, one parallel port, four USB ports support, watchdog timer and PCI to ISA bridge. Board size is 95mm by 114mm.

The ET839 has four board-to-board high-density interface connectors for I/O signals that plug onto baseboards specific to customer's applications. ETX embedded solutions provide fast time-to-market through the interchangeability and scalability of both the ETX module and the baseboard.

ETX stands for Embedded Technology extended, a technology or form factor that offers flexible time-to-market solution, enabling product development time to shrink from four months to just four weeks. It also features low power consumption and low heat emission, eliminating the need for a CPU fan.

Below are the main features of the ET839 ETX CPU module.

- Supports Atom™ E3800 series SoC processors
- DDR3L SO-DIMM, 1066/1333 MHz, Max. 4GB memory
- Integrated Graphics for VGA/LVDS displays
- PCI-Express 10/100 BaseT Ethernet
- SATA x1, USB 2.0 x4, COM x2, PCI x4

Checklist

Your ET839 package should include the items listed below.

- The ET839 CPU Module
- This User's Manual
- 1 CD containing chipset drivers and flash memory utility
- Serial ATA cable
- Heat spreader

ET839 Specifications

Form Factor	ETX 3.0 CPU module
CPU Type	Intel® Atom™ QC E3845 /2MB cache/1.91GHz Package = FCBGA1170, Type-3, 25mmx27mm, 22nm, Tj= -40° C to +110° C
BIOS	AMI
Memory	Intel® Atom™ SoC integrated memory controller, support DDR3L (1.35V) only 1 x DDR3 SO-DIMM socket on board, max. memory: 4GB (Non-ECC, Un-buffered)
VGA	Intel® Gen7 w/4 EUs graphics engines CRT x 1 [Support to 1920x1080@60Hz] derived to baseboard DDI Port x 1 [Support to 2560x1200@60Hz] thru daughter board thru FPC
LVDS	24-bit dual channel via NXP PTN3460 onboard thru eDP [Support to 1920x1200@60Hz]
LAN	Realtek 8106E 10/100 LAN
USB	Intel® Atom™ SoC built-in USB 2.0 host controller, supports 4 ports
Serial ATA Ports	Intel® Atom™ SoC built-in SATA II controller, supports 1 ports
Parallel IDE	Marvell 88SA8052 SATA to PATA bridge IC (support primary IDE only)
LPC I/O	Nuvoton NCT6102D COM#1/COM#2, keyboard/mouse, printer port
Audio	Realtek ALC662 HD Codec (Line-out, Line-in, Mic.)
RTC	Intel® Atom built-in RTC with on board battery
ISA BUS	Fintek F85226AF LPC to ISA PQFP package, 128-pin, 14mm x 20mm , 0 to +70 degree C
PCI BUS	ITE IT8892E, PCIe to PCI bridge IC LQFP-128 package, 14mm x 14mm, 0 to +70 degree C
Watch-Dog Timer	Yes (256 segments, 0, 1, 2...255. sec/min)
Connector to Carrier Board	Hirose FX8-100P-SV ETX connector x4 for PCI bus, USB, audio, VGA/CRT, LVDS, LAN, COM ports, parallel port, IDE, PS/2 Keyboard/Mouse & ISA bus
Power	+5V, 5VSB & 3V for RTC
RoHS Compliant	Yes
Board Size	95mm x 114mm

IMPORTANT NOTE:

Before installing the heatsink, the protective sheaths on the thermal pads should be removed first.

Board Dimensions

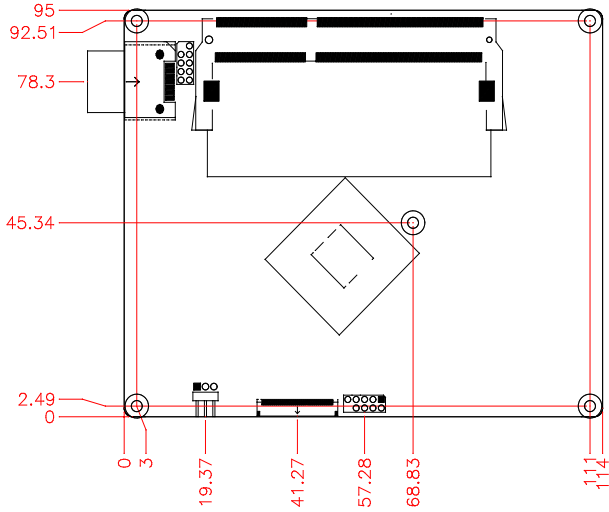

Top View

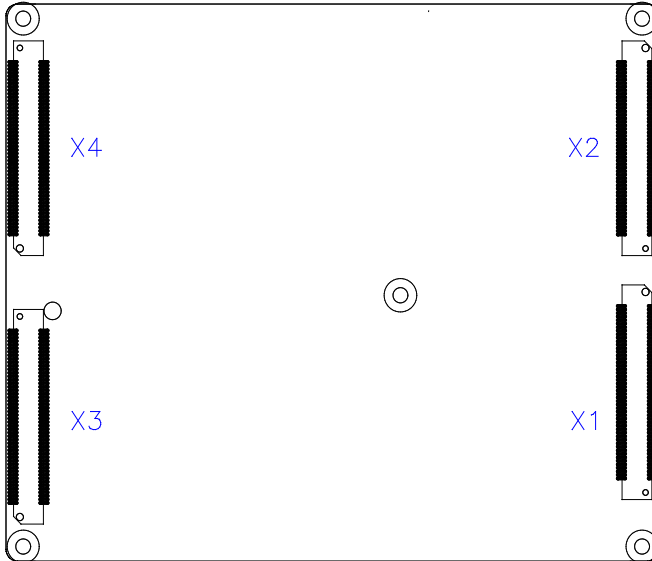

Bottom

Installations

This section provides information on how to use the jumpers and connectors on the ET839 in order to set up a workable system. The topics covered are:

Installing the Memory	6
Connector Pin Assignments	7
Setting the Jumpers	12

Installing the Memory

The ET839 board supports one DDR3L memory socket for a maximum total memory of 4GB in DDR3L SO-DIMM memory type. (w/o ECC function).

Installing and Removing Memory Modules

To install the DDR3 modules, locate the memory slot on the board and perform the following steps:

1. Hold the DDR3 module so that the key of the DDR3 module aligns with that on the memory slot. Insert the module into the socket at a slight angle (approximately 30 degrees). Note that the socket and module are both keyed, which means that the module can be installed only in one direction.
2. To seat the memory module into the socket, apply firm and even pressure to each end of the module until you feel it slip down into the socket.
3. With the module properly seated in the socket, rotate the module downward. Continue pressing downward until the clips at each end lock into position.
4. To remove the DDR3 module, press the clips with both hands.

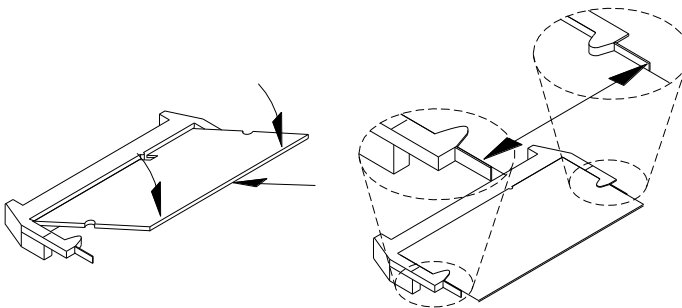

Connector Pin Assignments

1. X1 (PCI-Bus, USB, Sound)
2. X2 (ISA-Bus)
3. X3 (VGA, LCD, Video, COM, COM2, LPT, Mouse, Keyboard, LCD)
4. X4 (IDE 1, IDE 2, Ethernet, Misc)
5. CN1, CN2: Serial ATA Connectors

1. X1 (PCI-Bus, USB, Sound)

Pin	Signal	Pin	Signal	Pin	Signal	Pin	Signal
1	GND	2	GND	51	VCC	52	VCC
3	PCICLK3	4	PCICLK4	53	PAR	54	SERRJ
5	GND	6	GND	55	GPERRJ	56	N C
7	PCICLK1	8	PCICLK2	57	PMEJ	58	USB20
9	REQJ3	10	GNTJ3	59	LOCKJ	60	DEVSELJ
11	GNTJ2	12	3V	61	TRDYJ	62	USB30
13	REQJ2	14	GNTJ1	63	IRDYJ	64	STOPJ
15	REQJ 1	16	3V	65	FRAMEJ	66	USB21
17	GNTJ0	18	NC	67	GND	68	GND
19	VCC	20	VCC	69	AD16	70	CBEJ2
21	SERIRQ	22	REQJ0	71	AD17	72	USB31
23	AD0	24	3V	73	AD19	74	AD18
25	AD1	26	AD2	75	AD20	76	USB00
27	AD4	28	AD3	77	AD22	78	AD21
29	AD6	30	AD5	79	AD23	80	USB10
31	CBFJ0	32	AD7	81	AD24	82	CBEJ3
33	AD8	34	AD9	83	VCC	84	VCC
35	GND	36	GND	85	AD25	86	AD26
37	AD10	38	AUXAL	87	AD28	88	USB01
39	AD11	40	MIC	89	AD27	90	AD29
41	AD12	42	AUXAR	91	AD30	92	USB11
43	AD13	44	ASVCC	93	PCIRSTJ	94	AD31
45	AD14	46	SNDL	95	IRQY	96	IRQZ
47	AD15	48	ASGND	97	IRQW	98	IRQX
49	CBEJ1	50	SNDR	99	GND	100	GND

2. X2 (ISA-Bus)

Pin	Signal	Pin	Signal	Pin	Signal	Pin	Signal
1	GND	2	GND	51	VCC	52	VCC
3	SD14	4	SD15	53	SA6	54	IRQ5
5	SD13	6	MASTERJ	55	SA7	56	IR06
7	SD12	8	DREQ7	57	SA8	58	IRQ7
9	SD11	10	DACKJ7	59	SA9	60	SYSCLK
11	SD10	12	DREQ6	61	SA10	62	REFSHJ
13	SD9	14	DACKJ6	63	SA11	64	DREQ1
15	SD8	16	DREQ5	65	SA12	66	DACKJ 1
17	MEMWJ	18	DACKJ5	67	GND	68	GND
19	MEMRJ	20	DREQ0	69	SA13	70	DREQ3
21	LA17	22	DACKJ0	71	SA14	72	DACKJ3
23	LA18	24	IRQ14	73	SA15	74	IORJ
25	LA19	26	IR015	75	SA16	76	IOWJ
27	LA20	28	IRQ12	77	SA18	78	SA17
29	LA21	30	IRQ11	79	SA19	80	SMEMRJ
31	LA22	32	IRQ10	81	IOCHRDY	82	AEN
33	LA23	34	I016J	83	VCC	84	VCC
35	GND	36	GND	85	SD0	86	SMEMWJ
37	SBHEJ	38	M16J	87	SD2	88	SD1
39	SA0	40	OSC	89	SD3	90	NOWSJ
41	SA1	42	BALE	91	DREQ2	92	SD4
43	SA2	44	TC	93	SD5	94	IRQ9
45	SA3	46	DACKJ2	95	SD6	96	SD7
47	SA4	48	IR03	97	IOCHKJ	98	RSTDRV
49	SA5	50	IRQ4	99	GND	100	GND

3. X3 (VGA, LCD, Video, COM, COM2, LPT/Floppy, Mouse, Keyboard, LCD)

Pin	Signal	Pin	Signal	Pin	Signal	Pin	Signal
1	GND	2	GND	51	NC	52	NC
3	R	4	B	53	VCC	54	GND
5	HSY	6	G	55	/STB	56	/AFD
7	VSY	8	DDCK	57	NC	58	PD7
9	NC	10	DDDA	59	IRRX	60	/ERR
11	LCD DO16	12	NC	61	IRTX	62	PD7
13	LCD DO17	14	NC	63	RXD2	64	/INIT
15	GND	16	GND	65	GND	66	GND
17	LCD DO13	18	LCD DO15	67	RTS2J	68	PD5
19	LCD DO12	20	LCD DO14	69	DTR2J	70	/SLIN
21	GND	22	GND	71	DCD2J	72	PD4
23	NC	24	LCD DO11	73	DSR2J	74	PD3
25	NC	26	LCD DO10	75	CTS2J	76	PD2
27	GND	28	GND	77	TXD2J	78	PD1
29	LCD DO4	30	LCD DO7	79	RI2J	80	PD0
31	LCD DO5	32	LCD DO6	81	VCC	82	VCC
33	GND	34	GND	83	RXD1	84	/ACK
35	LCD DO1	36	LCD DO3	85	RTS1J	86	/BUSY
37	LCD DO0	38	LCD DO2	87	DTR1J	88	PE
39	VCC	40	VCC	89	DCD1J	90	/SLCT
41	NC	42	LTGIO0	91	DSR1J	92	MSCLK
43	NC	44	BLON#	93	CTS1J	94	MSDAT
45	BIASON	46	DIGON	95	TXD1	96	KBCLK
47	COMP	48	Y	97	RI1J	98	KBDAT
49	NC	50	C	99	GND	100	GND

4. X4 (IDE 1, IDE 2, Ethernet, Misc)

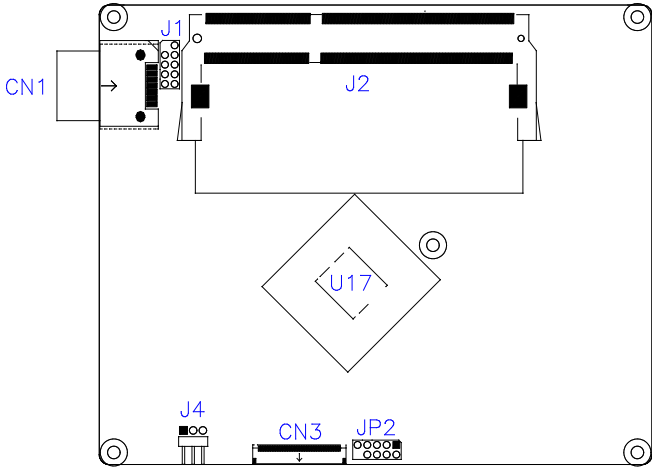

Pin	Signal	Pin	Signal	Pin	Signal	Pin	Signal
1	GND	2	GND	51	NC	52	PIDE_IORJ
3	5V SB	4	PWGIN	53	NC	54	PIDE_IOWJ
5	PS ON	6	SPEAKER	55	NC	56	PIDE_DRQ
7	PWRBTN#	8	BATT	57	NC	58	PIDE_D15
9	NC	10	LILED	59	NC	60	PIDE_DO
11	RSMRST#	12	ACTLED	61	NC	62	PIDE_D14
13	NC	14	SPEEDLED	63	NC	64	PIDE_D1
15	NC	16	NC	65	GND	66	GND
17	VCC	18	VCC	67	NC	68	PIDE_D13
19	OVCRJ	20	NC	69	NC	70	PIDE_D2
21	EXTSMI	22	NC	71	NC	72	PIDE_D12
23	SMBCLK	24	SMBDATA	73	NC	74	PIDE_D3
25	NC	26	NC	75	NC	76	PIDE_D11
27	NC	28	NC	77	NC	78	PIDE_D4
29	NC	30	PIDE_CS3J	79	NC	80	PIDE_D10
31	NC	32	PIDE_CS1J	81	VCC	82	VCC
33	GND	34	GND	83	NC	84	PIDE_D5
35	NC	36	PIDE_A2	85	NC	86	PIDE_D9
37	NC	38	PIDE_A0	87	NC	88	PIDE_D6
39	NC	40	PIDE_A1	89	NC	90	CBLID_P
41	BATLOW	42	NC	91	RXD-	92	PIDE_D8
43	NC	44	PIDE_INTRO	93	RXD+	94	NC
45	NC	46	PIDE_AKJ	95	TXD-	96	PIDE_D7
47	NC	48	PIDE_RDY	97	TXD+	98	HDRSTJ
49	VCC	50	VCC	99	GND	100	GND

5. CN1: Serial ATA Connectors



Setting the Jumpers

J4: ATX or AT Power Selection

JP4	ATX Power
 1 2 3	ATX
 1 2 3	AT

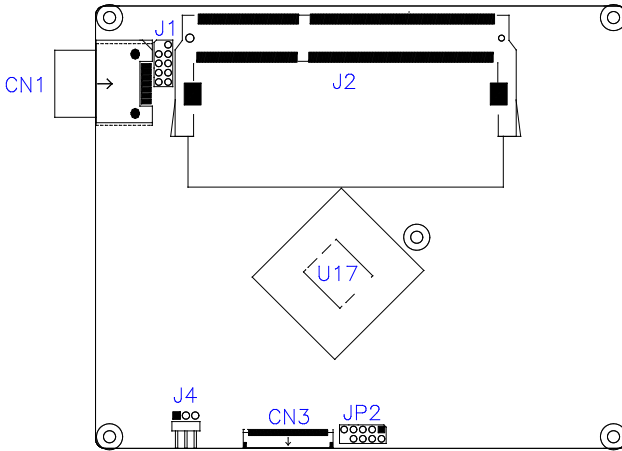

J1: SPI Flash connector (Factory use only)

JP2: Debug 80 Port Connector (factory use only)

BIOS Setup

This chapter describes the different settings available in the AMI BIOS that comes with the board. The topics covered in this chapter are as follows:

BIOS Introduction	14
BIOS Setup	14
Advanced Settings	16
Chipset Settings.....	21
Security Settings	22
Boot Settings	23
Save & Exit Settings.....	24

BIOS Introduction

The BIOS (Basic Input/Output System) installed in your computer system's ROM supports Intel processors. The BIOS provides critical low-level support for a standard device such as disk drives, serial ports and parallel ports. It also provides password protection as well as special support for detailed fine-tuning of the chipset controlling the entire system.

BIOS Setup

The BIOS provides a Setup utility program for specifying the system configurations and settings. The BIOS ROM of the system stores the Setup utility. When you turn on the computer, the BIOS is immediately activated. Pressing the key immediately allows you to enter the Setup utility. If you are a little bit late pressing the key, POST (Power On Self Test) will continue with its test routines, thus preventing you from invoking the Setup. If you still wish to enter Setup, restart the system by pressing the "Reset" button or simultaneously pressing the <Ctrl>, <Alt> and <Delete> keys. You can also restart by turning the system Off and back On again. The following message will appear on the screen:

```
Press <DEL> to Enter Setup
```

In general, you press the arrow keys to highlight items, <Enter> to select, the <PgUp> and <PgDn> keys to change entries, <F1> for help and <Esc> to quit.

When you enter the Setup utility, the Main Menu screen will appear on the screen. The Main Menu allows you to select from various setup functions and exit choices.

Warning: *It is strongly recommended that you avoid making any changes to the chipset defaults. These defaults have been carefully chosen by both AMI and your system manufacturer to provide the absolute maximum performance and reliability. Changing the defaults could cause the system to become unstable and crash in some cases.*

Main	Advanced	Chipset	Boot	Security	Save & Exit
BIOS Information					Choose the system default language
System Language			[English]		
System Date			[Tue 01/20/2014]		→ ← Select Screen
System Time			[21:52:06]		↑ ↓ Select Item
Access Level			Administrator		Enter: Select
					+ - Change Field
					F1: General Help
					F2: Previous Values
					F3: Optimized Default
					F4: Save ESC: Exit

System Date

Set the Date. Use Tab to switch between Data elements.

System Time

Set the Time. Use Tab to switch between Data elements.

Advanced Settings

This section allows you to configure and improve your system and allows you to set up some system features according to your preference.

Aptio Setup Utility					
Main	Advanced	Chipset	Boot	Security	Save & Exit
	<ul style="list-style-type: none"> ▶ LVDS (eDP/DP) Configuration ▶ NCT6102D Super IO Configuration ▶ NCT6102D Hardware Monitor ▶ CPU Configuration ▶ PPM Configuration ▶ IDE Configuration ▶ CSM Configuration ▶ USB Configuration 				→ ←Select Screen ↑↓ Select Item Enter: Select +- Change Opt. F1: General Help F2: Previous Values F3: Optimized Defaults F4: Save & Exit ESC: Exit

LVDS (eDP/DP) Configuration

Aptio Setup Utility - Copyright © 2015 American Megatrends, Inc.

Main	Advanced	Chipset	Boot	Security	Save & Exit
	LVDS (eDP/DP) Configuration				
	LVDS (eDP/DP) Support		[Disable]		→ ←Select Screen ↑↓ Select Item Enter: Select +- Change Opt. F1: General Help F2: Previous Values F3: Optimized Defaults F4: Save & Exit ESC: Exit

NCT6102D Super IO Configuration

Aptio Setup Utility – Copyright © 2015 American Megatrends, Inc.

Main	Advanced	Chipset	Boot	Security	Save & Exit
NCT6102D Super IO Configuration				Set Parameters of Serial Port	
Super IO Chip				→ ← Select Screen	
▶ Serial Port 1 Configuration				↑ ↓ Select Item	
▶ Serial Port 2 Configuration				Enter: Select	
▶ Parallel Port Configuration				+- Change Opt.	
				F1: General Help	
				F2: Previous Values	
				F3: Optimized Defaults	
				F4: Save & Exit	
				ESC: Exit	

Serial Port Configuration

Set Parameters of Serial Ports. User can Enable/Disable the serial port and Select an optimal settings for the Super IO Device

NCT6102D Hardware Monitor

Aptio Setup Utility – Copyright © 2015 American Megatrends, Inc.

Main	Advanced	Chipset	Boot	Security	Save & Exit
PC Health Status					
ACPI Shutdown Temperature			Disabled	→ ← Select Screen	
				↑ ↓ Select Item	
				Enter: Select	
System temperature			+34.5 C	+- Change Opt.	
CPU temperature			+37.0 C	F1: General Help	
Vcore			+0.824 V	F2: Previous Values	
5V			+5.129 V	F3: Optimized Defaults	
VDD			+1.368 V	F4: Save & Exit	
				ESC: Exit	

ACPI Shutdown Temperature

This field enables or disables the Shutdown Temperature

Disabled (default)

70 °C/158 F

75 °C/167 F

80 °C/176 F

85 °C/185 F

90 °C/194 F

95 °C/203 F

Temperatures/Voltages

These fields are the parameters of the hardware monitoring function feature of the motherboard. The values are read-only values as monitored by the system and show the PC health status

CPU Configuration

This section shows the CPU configuration parameters.

Aptio Setup Utility - Copyright © 2015 American Megatrends, Inc.

Main	Advanced	Chipset	Boot	Security	Save & Exit
CPU Configuration					
▶ Socket 0 CPU Information					
CPU Speed			1918 Mhz		→ ← Select Screen
64-bit			Supported		↑ ↓ Select Item
Intel Virtualization Technology			[Enable]		Enter: Select
Power Technology			[Energy Efficient]		+ - Change Opt.
					F1: General Help
					F2: Previous Values
					F3: Optimized Defaults
					F4: Save & Exit
					ESC: Exit

Socket 0 CPU Information

Socket specific CPU Information.

IDE Configuration

SATA Devices Configuration.

Aptio Setup Utility – Copyright © 2013 American Megatrends, Inc.

Main	Advanced	Chipset	Boot	Security	Save & Exit
IDE Configuration					
Serial-ATA (SATA)		Enabled			
SATA Test Mode		Disable			
SATA Speed Support		Gen 2			
SATA ODD Port		No ODD			
SATA Mode		AHCI			
Serial-ATA Port 0		Enabled			
SATA Port0 HotPlug		Disabled			
SATA to PATA Port		Disabled			
SATA Port0		Not Present			
SATA Port1		Not Present			
				→ ← Select Screen	
				↑ ↓ Select Item	
				Enter: Select	
				+- Change Field	
				F1: General Help	
				F2: Previous Values	
				F3: Optimized Default	
				F4: Save ESC: Exit	

Serial-ATA(SATA)

Enabled / Disabled Serial ATA

SATA Mode

Select IDE / AHCI Mode

Serial –ATA Port 0

Enabled / Disabled Serial Port 0

SATA Port0 HotPlug

Enabled / Disabled SATA Port 0 HotPlug

Serial –ATA Port 1

Enabled / Disabled Serial Port 1

SATA Port1 HotPlug

Enabled / Disabled SATA Port 1 HotPlug

SATA to PATA Port

Enabled / use IDE HardDisk

Disabled / Not use IDE HardDisk

CSM Configuration

Aptio Setup Utility – Copyright © 2015 American Megatrends, Inc.

Main	Advanced	Chipset	Boot	Security	Save & Exit
Compatibility Support Module Configuration					
CSM Support		Enable			
CSM Module Version		07.76			→ ← Select Screen
GateA20 Active		Upon Request			↑ ↓ Select Item
Option ROM Messages		Force BIOS			Enter: Select
Boot option filter		UEFI and Legacy			+ - Change Field
Option ROM execution					F1: General Help
Network		UEFI			F2: Previous Values
Storage		Legacy			F3: Optimized Default
Video		Legacy			F4: Save ESC: Exit
Other PCI devices		UEFI			

CSM Support

Enabled/Disabled CSM Support

GateA20 Active

UPON REQUEST – GA20 can be disabled using BIOS services.

ALWAYS – do not allow

Disabling GA20; this option is useful when any RT code is executed above 1MB

Option ROM Messages

Set display node for Option ROM

Boot option filter

This option controls Legacy / UEFI ROMs priority

Network

Controls the execution of UEFI and Legacy PXE OpROM

Storage

Controls the execution of UEFI and Legacy Storage OpROM

Video

Controls the execution of UEFI and Legacy Video OpROM

Other PCI devices

Determines OpROM execution policy for devices other than Network, Storage, or Video

Chipset Settings

Aptio Setup Utility – Copyright © 2015 American Megatrends, Inc.

Main	Advanced	Chipset	Boot	Security	Save & Exit
<ul style="list-style-type: none"> ▶ North Bridge ▶ South Bridge 					

North Bridge

Aptio Setup Utility – Copyright © 2015 American Megatrends, Inc.

Main	Advanced	Chipset	Boot	Security	Save & Exit
Memory Information					→ ← Select Screen
Total Memory			2048 MB (DDR3L)	↑ ↓ Select Item	
Memory Slot0			2048 MB (DDR3L)	Enter: Select	
Max TOLUD			Dynamic	+- Change Opt.	
					F1: General Help
					F2: Previous Values
					F3: Optimized Defaults
					F4: Save & Exit
					ESC: Exit

South Bridge

Aptio Setup Utility – Copyright © 2015 American Megatrends, Inc.

Main	Advanced	Chipset	Boot	Security	Save & Exit
Restore AC Power Loss			Power off	→ ← Select Screen	
Global SMI Lock			Enable	↑ ↓ Select Item	
BIOS Read/Write Protection			Enable	Enter: Select	
					+- Change Opt.
					F1: General Help
					F2: Previous Values
					F3: Optimized Defaults
					F4: Save & Exit
					ESC: Exit

Restore AC Power Loss

Select AC power state when power is re-applied after a power failure

Global SMI Lock

Enabled/Disabled SMI Lock

BIOS Read/Write Protection

Enabled or Disabled BIOS SPI region read / write protect

Security Settings

This section allows you to configure and improve your system and allows you to set up some system features according to your preference.

Aptio Setup Utility - Copyright © 2015 American Megatrends, Inc.

Main	Advanced	Chipset	Boot	Security	Save & Exit
Password Description					
If ONLY the Administrator's password is set, then this only limit access to Setup and is only asked for when entering Setup.					
If ONLY the User's password is set, then this is a power on password and must be entered to boot or enter Setup. In Setup the User will have Administrator rights					
The password length must be in the following range:					
Minimum length			3		
Maximum length			20		
Administrator Password					
User Password					
					→ ← Select Screen ↑ ↓ Select Item Enter: Select +- Change Opt. F1: General Help F2: Previous Values F3: Optimized Defaults F4: Save & Exit ESC: Exit

Administrator Password

Set Administrator Password.

User Password

Set User Password

Boot Settings

This section allows you to configure the boot settings.

Aptio Setup Utility – Copyright © 2015 American Megatrends, Inc.

Main	Advanced	Chipset	Boot	Security	Save & Exit
Boot Configuration					
Setup Prompt Timeout			1		
Bootup NumLock State			Off		
Quiet Boot			Disabled		
Fast Boot			Disabled		
Boot mode select			LEGACY		
FIXED BOOT ORDER Priorities					
Boot Option #1			Hard Disk		→ ← Select Screen
Boot Option #2					↑ ↓ Select Item
Boot Option #3					Enter: Select
Boot Option #4					+ - Change Opt.
Boot Option #5					F1: General Help
Boot Option #6					F2: Previous Values
Boot Option #7					F3: Optimized Defaults
Boot Option #8					F4: Save & Exit
▶ Hard Disk Drive BBS Priorities					ESC: Exit

Setup Prompt Timeout

Number of seconds to wait for setup activation key.

65535(0xFFFF) means indefinite waiting.

Bootup NumLock State

Select the keyboard NumLock state.

Quiet Boot

Enables or disables Quiet Boot option.

Fast Boot

Enables or disables boot with initialization of a minimal set of devices required to launch active boot option. Has no effect for BBS boot options.

Boot Option Priorities

Sets the system boot order.

Save & Exit Settings

Aptio Setup Utility - Copyright © 2013 American Megatrends, Inc.

Main	Advanced	Chipset	Boot	Security	Save & Exit
Save Changes and Exit					
Discard Changes and Exit					
Save Changes and Reset					
Discard Changes and Reset					
Save Options					→ ← Select Screen
Save Changes					↑ ↓ Select Item
Discard Changes					Enter: Select
					+ - Change Opt.
Restore Defaults					F1: General Help
Save as User Defaults					F2: Previous Values
Restore User Defaults					F3: Optimized Defaults
					F4: Save & Exit
					ESC: Exit

Save Changes and Exit

Exit system setup after saving the changes.

Discard Changes and Exit

Exit system setup without saving any changes.

Save Changes and Reset

Reset the system after saving the changes.

Discard Changes and Reset

Reset system setup without saving any changes.

Save Changes

Save Changes done so far to any of the setup options.

Discard Changes

Discard Changes done so far to any of the setup options.

Restore Defaults

Restore/Load Defaults values for all the setup options.

Save as User Defaults

Save the changes done so far as User Defaults.

Restore User Defaults

Restore the User Defaults to all the setup options.

Drivers Installation

This section describes the installation procedures for software and drivers. The software and drivers are included with the motherboard. If you find the items missing, please contact the vendor where you made the purchase. The contents of this section include the following:

Intel Chipset Software Installation Utility	26
VGA Drivers Installation.....	27
Realtek High Definition Audio Driver Installation	28
Intel Trusted Execution Engine Installation.....	29
LAN Drivers Installation	30

IMPORTANT NOTE:

After installing your Windows operating system, you must install first the Intel Chipset Software Installation Utility before proceeding with the drivers installation.

Intel Chipset Software Installation Utility

The Intel Chipset Drivers should be installed first before the software drivers to enable Plug & Play INF support for Intel chipset components. Follow the instructions below to complete the installation.

1. Insert the DVD that comes with the board. Click *Intel* and then *Intel(R) Baytrail Chipset*. Click *Intel(R) Chipset Software Installation Utility*.



2. When the Welcome screen to the Intel® Chipset Device Software appears, click *Next* to continue.

3. Click *Yes* to accept the software license agreement and proceed with the installation process.

4. The Setup process is now complete. Click *Finish* to restart the computer and for changes to take effect.

VGA Drivers Installation

1. Insert the DVD that comes with the board. Click *Intel* and then *Intel(R) Baytrail Chipset*. Click *Intel(R) Baytrail Graphics Driver*.



2. When the Welcome screen appears, click *Next* to continue.
3. Click *Yes* to accept the license agreement and continue the installation.
4. Setup complete. Click *Finish* to restart the computer and for changes to take effect.



Realtek High Definition Audio Driver Installation

1. Insert the DVD that comes with the board. Click *Intel* and then *Intel(R) Baytrail Chipset*. Click *Realtek High Definition Audio Driver*.



2. On the Welcome screen, click *Next* to proceed with the installation.

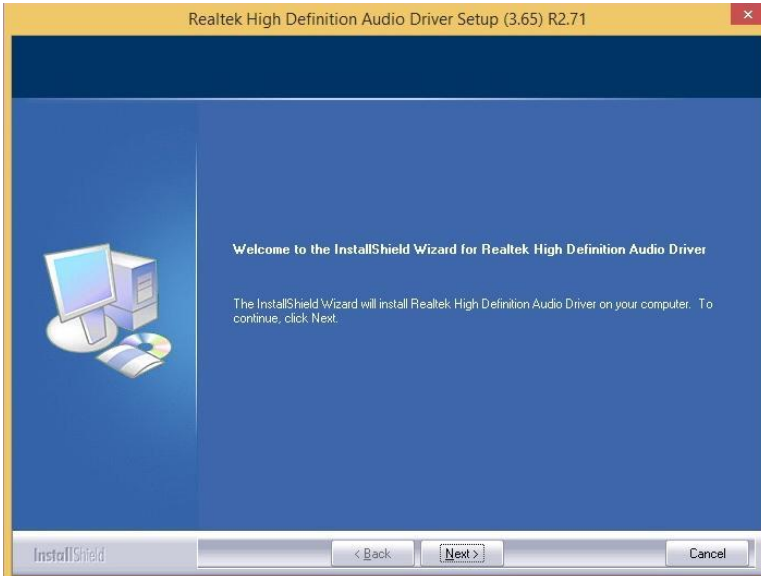

3. InstallShield Wizard is complete. Click *Finish* to restart the computer and for changes to take effect.

Intel Trusted Execution Engine Installation

1. Insert the DVD that comes with the board. Click *Intel* and then *Intel(R) Baytrail Chipset*. Click *Intel(R) TXE Driver*.



2. On the Setup Welcome screen, click *Next* to proceed with the installation process.

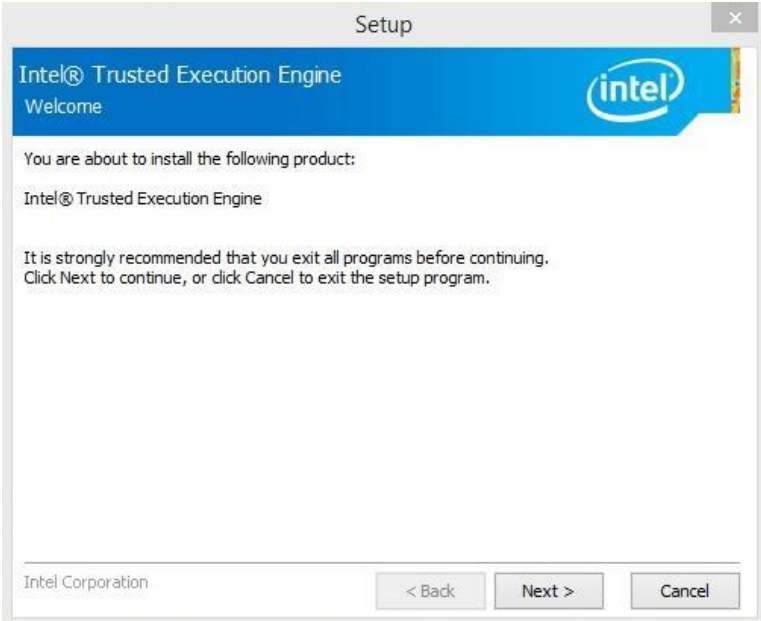

3. Click *Next* accept the license agreement and continue the installation.

4. Installation of the Intel Trusted Execution Engine is now complete. Click *Finish*.

LAN Drivers Installation

1. Insert the DVD that comes with the board. Click *Intel* and then *Intel(R) Baytrail Chipset* .Click *Realtek LAN Controller Drivers*.



2. Click *Realtek RTL811G LAN Driver*.



3. Click *Install Drivers and Software*.
4. When the Welcome screen appears, click *Next*.
5. Click *Next* to to agree with the license agreement.
6. Click the checkbox for **Drivers** in the Setup Options screen to select it and click **Next** to continue.
7. The wizard is ready to begin installation. Click *Install* to begin the installation.
8. When InstallShield Wizard is complete, click *Finish*.

Appendix

A. I/O Port Address Map

Each peripheral device in the system is assigned a set of I/O port addresses that also becomes the identity of the device. The following table lists the I/O port addresses used.

Address	Device Description
000h – 06Fh	PCI bus
040h – 043h	System timer
050h – 053h	System timer
060h – 060h	Standard PS/2 Keyboard
070h – 077h	System CMOS/Real Time Clock
078h – CF7h	PCI bus
170h – 177h	ATA Channel 1
1F0h – 1F7h	ATA Channel 0
2F8h – 2FFh	Serial Port #2(COM2)
3F8h – 3FFh	Serial Port #1(COM1)
778h – 77Fh	ECP Printer Port (LPT1)
0D00 – FFFF	PCI-e Root Complex

B. Interrupt Request Lines (IRQ)

Peripheral devices use interrupt request lines to notify CPU for the service required. The following table shows the IRQ used by the devices on board.

Level	Function
IRQ0	System Timer
IRQ1	Standard PS/2 Keyboard
IRQ3	Serial Port #2
IRQ4	Serial Port #1
IRQ8	High precision event timer
IRQ12	PS/2 Compatible Mouse
IRQ14	ATA Channel 0
IRQ15	ATA Channel 1
IRQ18	PCI Standard PCI-to-PCI bridge
IRQ22	High Definition Audio Controller

C. Watchdog Timer Configuration

The WDT is used to generate a variety of output signals after a user programmable count. The WDT is suitable for use in the prevention of system lock-up, such as when software becomes trapped in a deadlock. Under these sorts of circumstances, the timer will count to zero and the selected outputs will be driven. Under normal circumstance, the user will restart the WDT at regular intervals before the timer counts to zero.

SAMPLE CODE:

```
//-----
//
// THIS CODE AND INFORMATION IS PROVIDED "AS IS" WITHOUT WARRANTY OF ANY
// KIND, EITHER EXPRESSED OR IMPLIED, INCLUDING BUT NOT LIMITED TO THE
// IMPLIED WARRANTIES OF MERCHANTABILITY AND/OR FITNESS FOR A PARTICULAR
// PURPOSE.
//-----
#include <dos.h>
#include <conio.h>
#include <stdio.h>
#include <stdlib.h>
#include "6106"
//-----
int main (int argc, char *argv[]);
void EnableWDT(int);
void DisableWDT(void);
//-----
int main (int argc, char *argv[])
{
    unsigned char bBuf;
    unsigned char bTime;
    char **endptr;

    char SIO;

    printf("6106 watch dog program\n");

    bTime = strtol (argv[1], endptr, 10);
    printf("System will reset after %d seconds\n", bTime);

    if (bTime)
    {
        else
        {
            if (bTime > 0 && bTime < 256)
            {
                A=2;

                unsigned char result;
                Set_6106_LD(0x08);

                gotoxy(1,12);

            }
        }
    }
}
```

```

}
//-----
void EnableWDT(int interval)
{
    return 0;

    unsigned char bBuf;

    Set_6106_LD(0x08);
    Set_6106_Reg(0x30, 0x01);

    Set_6106_Reg(0xF1, interval);

}
//-----
void DisableWDT(void)
{
    unsigned char bBuf;

    Set_6106_LD(0x08);
    Set_6106_Reg(0x30, 0x00);

}
//-----
```

```

//-----
//
// THIS CODE AND INFORMATION IS PROVIDED "AS IS" WITHOUT WARRANTY OF ANY
// KIND, EITHER EXPRESSED OR IMPLIED, INCLUDING BUT NOT LIMITED TO THE
// IMPLIED WARRANTIES OF MERCHANTABILITY AND/OR FITNESS FOR A PARTICULAR
// PURPOSE.
//
//-----
#include "6106.H"
#include <dos.h>
//-----
unsigned int 6106_BASE;
void Unlock_6106 (void);
void Lock_6106 (void);
//-----
unsigned int Init_6106(void)
{
    unsigned int result;
    unsigned char ucDid;

    6106_BASE = 0x4E;
    result = 6106_BASE;

    ucDid = Get_6106_Reg(0x20);
    if (ucDid == 0x07) //6106
    {
        goto Init_Finish;
    }

    6106_BASE = 0x2E;
    result = 6106_BASE;

    ucDid = Get_6106_Reg(0x20);
    if (ucDid == 0x07) //6106
    {
        goto Init_Finish;
    }

    6106_BASE = 0x00;
    result = 6106_BASE;

Init_Finish:
    return (result);
}
//-----
void Unlock_6106 (void)
{
    outportb(6106_INDEX_PORT, 6106_UNLOCK);
    outportb(6106_INDEX_PORT, 6106_UNLOCK);
}
//-----
void Lock_6106 (void)
{
    outportb(6106_INDEX_PORT, 6106_LOCK);
}
//-----
void Set_6106_LD (unsigned char LD)
{
    Unlock_6106();
    outportb(6106_INDEX_PORT, 6106_REG_LD);
    outportb(6106_DATA_PORT, LD);
    Lock_6106();
}
//-----
void Set_6106_Reg (unsigned char REG, unsigned char DATA)
{
    Unlock_6106();
    outportb(6106_INDEX_PORT, REG);
    outportb(6106_DATA_PORT, DATA);
    Lock_6106();
}
//-----
unsigned char Get_6106_Reg(unsigned char REG)

```

```
{
    unsigned char Result;
    Unlock_6106();
    outportb(6106_INDEX_PORT, REG);
    Result = inportb(6106_DATA_PORT);
    Lock_6106();
    return Result;
}
//-----
```

This page is intentionally left blank.