

EPI-QM57

Intel® Calpella EPIC Module with Intel® QM57

User's Manual

1st Ed – 2 November 2010

FCC Statement



THIS DEVICE COMPLIES WITH PART 15 FCC RULES. OPERATION IS SUBJECT TO THE FOLLOWING TWO CONDITIONS:

(1) THIS DEVICE MAY NOT CAUSE HARMFUL INTERFERENCE.

(2) THIS DEVICE MUST ACCEPT ANY INTERFERENCE RECEIVED INCLUDING INTERFERENCE THAT MAY CAUSE UNDESIRE OPERATION.

THIS EQUIPMENT HAS BEEN TESTED AND FOUND TO COMPLY WITH THE LIMITS FOR A CLASS "A" DIGITAL DEVICE, PURSUANT TO PART 15 OF THE FCC RULES.

THESE LIMITS ARE DESIGNED TO PROVIDE REASONABLE PROTECTION AGAINST HARMFUL INTERFERENCE WHEN THE EQUIPMENT IS OPERATED IN A COMMERCIAL ENVIRONMENT. THIS EQUIPMENT GENERATES, USES, AND CAN RADIATE RADIO FREQUENCY ENERGY AND, IF NOT INSTALLED AND USED IN ACCORDANCE WITH THE INSTRUCTION MANUAL, MAY CAUSE HARMFUL INTERFERENCE TO RADIO COMMUNICATIONS.

OPERATION OF THIS EQUIPMENT IN A RESIDENTIAL AREA IS LIKELY TO CAUSE HARMFUL INTERFERENCE IN WHICH CASE THE USER WILL BE REQUIRED TO CORRECT THE INTERFERENCE AT HIS OWN EXPENSE.

Notice

This guide is designed for experienced users to setup the system within the shortest time. For detailed information, please always refer to the electronic user's manual.

Copyright Notice

Copyright © 2010 Avalue Technology Inc., ALL RIGHTS RESERVED.

No part of this document may be reproduced, copied, translated, or transmitted in any form or by any means, electronic or mechanical, for any purpose, without the prior written permission of the original manufacturer.

Trademark Acknowledgement

Brand and product names are trademarks or registered trademarks of their respective owners.

Disclaimer

Avalue Technology Inc. reserves the right to make changes, without notice, to any product, including circuits and/or software described or contained in this manual in order to improve design and/or performance. Avalue Technology assumes no responsibility or liability for the use of the described product(s), conveys no license or title under any patent, copyright, or masks work rights to these products, and makes no representations or warranties that these products are free from patent, copyright, or mask work right infringement, unless

otherwise specified. Applications that are described in this manual are for illustration purposes only. Avalue Technology Inc. makes no representation or warranty that such application will be suitable for the specified use without further testing or modification.

Life Support Policy

Avalue Technology's PRODUCTS ARE NOT FOR USE AS CRITICAL COMPONENTS IN LIFE SUPPORT DEVICES OR SYSTEMS WITHOUT THE PRIOR WRITTEN APPROVAL OF Avalue Technology Inc.

As used herein:

1. Life support devices or systems are devices or systems which, (a) are intended for surgical implant into body, or (b) support or sustain life and whose failure to perform, when properly used in accordance with instructions for use provided in the labeling, can be reasonably expected to result in significant injury to the user.
2. A critical component is any component of a life support device or system whose failure to perform can be reasonably expected to cause the failure of the life support device or system, or to affect its safety or effectiveness.

A Message to the Customer

Avalue Customer Services

Each and every Avalue's product is built to the most exacting specifications to ensure reliable performance in the harsh and demanding conditions typical of industrial environments. Whether your new Avalue device is destined for the laboratory or the factory floor, you can be assured that your product will provide the reliability and ease of operation for which the name Avalue has come to be known.

Your satisfaction is our primary concern. Here is a guide to Avalue's customer services. To ensure you get the full benefit of our services, please follow the instructions below carefully.

Technical Support

We want you to get the maximum performance from your products. So if you run into technical difficulties, we are here to help. For the most frequently asked questions, you can easily find answers in your product documentation. These answers are normally a lot more detailed than the ones we can give over the phone. So please consult the user's manual first.

To receive the latest version of the user's manual; please visit our Web site at:

<http://www.avalue.com.tw/>

EPI-QM57

If you still cannot find the answer, gather all the information or questions that apply to your problem, and with the product close at hand, call your dealer. Our dealers are well trained and ready to give you the support you need to get the most from your Avalue's products. In fact, most problems reported are minor and are able to be easily solved over the phone. In addition, free technical support is available from Avalue's engineers every business day. We are always ready to give advice on application requirements or specific information on the installation and operation of any of our products. Please do not hesitate to call or e-mail us.

Headquarters and Branch	Avalue USA
Avalue Technology Inc. 7F, 228, Lian-cheng Road, Chung Ho City, Taipei, Taiwan Tel: +886-2-8226-2345 Fax: +886-2-8226-2777 Information: sales@avalue.com.tw Service: service@avalue.com.tw	Avalue Technology Inc. 200 Tornillo Way, Suite 210, Tinton Falls, NJ 07712 Tel: +1-732-578-0200 Fax: +1-732-578-0250 Information: sales@avalue-usa.com Service: support@avalue-usa.com
BCM Advanced Research	Avalue Europe
BCM Advanced Research an Avalue Company 7 Marconi, Irvine, CA92618 Tel: +1-949-470-1888 Fax: +1-949-470-0971 Information: BCMSales@bcmcom.com Web: www.bcmcom.com	Avalue Europe A/S Moelledalen 22C, 3140 Aalsgaarde, Denmark Tel: +45-7025-0310 Fax: +45-4975-5026 Information: sales.europe@avalue.com.tw Service: service.europe@avalue.com.tw
Avalue China	Avalue Japan
Avalue Technology Inc. Room 805, Building 9, No.99 Tianzhou Rd., Caohejing Development Area, Xuhui District, Shanghai Tel: +86-21-5169-3609 Fax: +86-21-5445-3266 Information: sales.china@avalue.com.cn Service: service@avalue.com.tw	Avalue Technology Inc. 2F keduka-Bldg, 2-27-3 Taito, Taito-Ku, Tokyo 110-0016 Japan Tel: +81-3-5807-2321 Fax: +81-3-5807-2322 Information: sales.japan@avalue.com.tw Service: service@avalue.com.tw

Product Warranty

Avalue warrants to you, the original purchaser, that each of its products will be free from defects in materials and workmanship for two years from the date of purchase.

This warranty does not apply to any products which have been repaired or altered by persons other than repair personnel authorized by Avalue, or which have been subject to misuse, abuse, accident or improper installation. Avalue assumes no liability under the terms of this warranty as a consequence of such events. Because of Avalue's high quality-control standards and rigorous testing, most of our customers never need to use our repair service. If any of Avalue's products is defective, it will be repaired or replaced at no charge during the warranty period. For out-of-warranty repairs, you will be billed according to the cost of replacement materials, service time, and freight. Please consult your dealer for more details. If you think you have a defective product, follow these steps:

1. Collect all the information about the problem encountered. (For example, CPU type and speed, Avalue's products model name, hardware & BIOS revision number, other hardware and software used, etc.) Note anything abnormal and list any on-screen messages you get when the problem occurs.
2. Call your dealer and describe the problem. Please have your manual, product, and any helpful information available.
3. If your product is diagnosed as defective, obtain an RMA (return material authorization) number from your dealer. This allows us to process your good return more quickly.
4. Carefully pack the defective product, a complete Repair and Replacement Order Card and a photocopy proof of purchase date (such as your sales receipt) in a shippable container. A product returned without proof of the purchase date is not eligible for warranty service.
5. Write the RMA number visibly on the outside of the package and ship it prepaid to your dealer.

Contents

1.1	Safety Precautions	9
1.2	Packing List.....	9
1.3	Document Amendment History	10
1.4	Manual Objectives.....	11
1.5	System Specifications	12
1.6	Architecture Overview – Block Diagram.....	14
2.1	Product Overview.....	16
2.2	Installation Procedure	17
2.2.1	Main Memory.....	18
2.3	Jumper and Connector List.....	20
2.4	Setting Jumpers & Connectors	22
2.4.1	Clear CMOS (JBAT1).....	22
2.4.2	Serial port 1 - Ring, +5V, +12V power select (JRI1).....	22
2.4.3	Miscellaneous setting connector (JFP1).....	23
2.4.4	Touch panel connector (JTOUCH_SEL1).....	24
2.4.5	AT/ATX mode select (PWR_MSEL1).....	24
2.4.6	Battery connector (BBAT1)	25
2.4.7	Audio connector (CN1).....	25
2.4.8	CPU fan / System fan connector (CPU_FAN1/ SYS_FAN1).....	26
2.4.9	PS/2 keyboard & mouse connector (JKB/MS1)	26
2.4.10	Primary IDE connector (IDE1)	27
2.4.11	Serial port 2 In RS-422/485 mode connector (J422/485).....	28
2.4.12	HD power connector (HD_PWR).....	28
2.4.13	LCD Inverter Connector 1/ 2 (JBKL1/ JBKL2).....	29
2.4.13.1	Signal Description – LCD Inverter Connector (JBKL1).....	29
2.4.14	5VSB connector in ATX (PWR_SB1)	30
2.4.15	Serial port 1/ 2 connector (JCOM1/ JCOM2).....	30
2.4.16	IrDA connector (JIR1)	31
2.4.17	Touch panel connector (JTOUCH1)	32
2.4.18	General purpose I/O connector (JDIO1).....	33
2.4.19	For Express Card Daughter Board Use (JEXP1)	34
2.4.20	Power connector (POWCON1).....	34
2.4.21	SPI connector (JSPI1)	35
2.4.22	USB connector 4&5/ 6&7 (JUSB1/ JUSB2).....	35
2.4.23	LVDS connector (JLVDS1)	36
3.1	Introduction	38
3.2	Starting Setup	38

3.3	Using Setup	39
3.4	Getting Help	40
3.5	In Case of Problems	40
3.6	BIOS setup	41
3.5.1	Main Menu	41
3.5.1.1	System Language	41
3.5.1.2	System Date	41
3.5.1.3	System Time	42
3.5.2	Advanced Menu	42
3.5.2.1	PCI subsystem Settings	43
3.5.2.2	ACPI Settings	45
3.5.2.3	CPU Configuration	46
3.5.2.4	SATA Configuration	47
3.5.2.5	Thermal Configuration	48
3.5.2.6	Intel IGD SWSCI OpRegion	49
3.5.2.7	Intel TDT (AT-p) Configuration	51
3.5.2.8	Intel TXT (LT) Configuration	52
3.5.2.9	USB Configuration	52
3.5.2.9.1	Legacy USB support	53
3.5.2.9.2	ECHI hand-off	53
3.5.2.9.3	Device Reset timeout	53
3.5.2.9.4	Mass Storage Devices	53
3.5.2.10	H/W Monitor	53
3.5.2.11	Super IO Configuration	54
3.5.2.12.1	Serial Port 0 Configuration	55
3.5.2.12.2	Serial Port 1 Configuration	56
3.5.2.12	Intelligent Power Sharing	57
3.5.2.13	AMT Configuration	58
3.5.3	Advanced Chipset Features	59
3.5.3.1	North Bridge	60
3.5.3.2	South Bridge	61
3.5.3.3	ME Subsystem	64
3.5.4	Boot	65
3.5.5	Security	66
3.5.5.1	Administrator Password	66
3.5.5.2	User Password	66
3.5.6	Save & Exit	67
3.5.6.1	Save changes and exit	67
3.5.6.2	Discard Changes and Exit	68
3.5.6.3	Save changes and Reset	68

EPI-QM57

3.5.6.4	Discard Changes and Reset.....	69
3.5.6.5	Save changes	69
3.5.6.6	Discard Changes	70
3.5.6.7	Restore Defaults.....	70
3.5.6.8	Save as User Defaults.....	71
3.5.6.9	Restore User Defaults	71
4.1	Install Chipset Driver (For Intel QM57).....	73
4.2	Install Display Driver (For Intel QM57)	74
4.3	Install Audio Driver (For Realtek ALC883)	75
4.4	Install Ethernet Driver (For Intel 82574L/ 82577LM)	76

1. Getting Started

1.1 Safety Precautions

Warning!



Always completely disconnect the power cord from your chassis whenever you work with the hardware. Do not make connections while the power is on. Sensitive electronic components can be damaged by sudden power surges. Only experienced electronics personnel should open the PC chassis.

Caution!



Always ground yourself to remove any static charge before touching the CPU card. Modern electronic devices are very sensitive to static electric charges. As a safety precaution, use a grounding wrist strap at all times. Place all electronic components in a static-dissipative surface or static-shielded bag when they are not in the chassis.

1.2 Packing List

Before you begin installing your single board, please make sure that the following materials have been shipped:

- 1 x Quick Installation Guide for EPI-QM57
- 1 x Cable set contains the followings:
 - 1 x IDE HDD cable (44-pin, pitch 2.0mm)
 - 1 x COM port cable (20-pin to 2 x DB9(M))
 - 1 x Serial ATA cable (7-pin, standard)
 - 1 x Serial ATA power cable



If any of the above items is damaged or missing, contact your retailer.

1.3 Document Amendment History

Revision	Date	Comment
1 st	July 2010	Initial Release

1.4 Manual Objectives

This manual describes in detail the Avalue Technology EPI-QM57 Single Board.





We have tried to include as much information as possible but we have not duplicated information that is provided in the standard IBM Technical References, unless it proved to be necessary to aid in the understanding of this board.



We strongly recommend that you study this manual carefully before attempting to interface with EPI-QM57 series or change the standard configurations. Whilst all the necessary information is available in this manual we would recommend that unless you are confident, you contact your supplier for guidance.

Please be aware that it is possible to create configurations within the CMOS RAM that make booting impossible. If this should happen, clear the CMOS settings, (see the description of the Jumper Settings for details).

If you have any suggestions or find any errors concerning this manual and want to inform us of these, please contact our Customer Service department with the relevant details.

1.5 System Specifications

System 	
CPU	Onboard LV Intel® Core™ i7-620LE or ULV Intel® Core™ i7-620UE Processor
BIOS	AMI 64Mbit Flash BIOS
System Chipset	Intel® QM57
I/O Chip	Winbond W83627DHG-P
System Memory	One 204-pin SODIMM Socket Supports up to 4GB DDR3 800/ 1066 SDRAM
SSD	One CompactFlash Type I/II Socket
Watchdog Timer	Reset: 1sec. ~ 65535min. and 1sec. or 1min./step
Expansion	One Express Card/ 34mm Slot (Optional)
I/O 	
MIO	1 x EIDE, 4 x SATA, 1 x KB & Mouse, 1 x RS-232, 1 x RS-232/ 422/ 485
IrDA	115Kbps, IrDA 1.0 Compliant
USB	8 x USB 2.0
DIO	8-bit GPI, 8-bit GPO
Display 	
Chipset	Intel® QM57
Resolution	DVI Mode: 1920 x 1536 @ 75Hz (DVI-I) LCD/ Simultaneous Mode : 1600 x 1200 @ 75Hz
Multiple Display	DVI + LVDS
LVDS	Dual-channel 18/ 24-bit LVDS
DVI	DVI-I Chrontel CH7318B
Built-In Touch Screen(Optional) 	
Chipset	PenMount 6000
Touch Screen Interface	With 9-pin 2.0mm Box Header (Can be Selected to Support 4/ 5/ 8-wire Touch Screen)
Audio 	
AC97 Codec	Realtek ALC883 Supports 5.1-CH Audio
Audio Interface	Mic-in, Line-in, Line-out

Ethernet 	
LAN	1 x Intel® 82577LM (Gigabit PHY) 1 x Intel® 82574L
Ethernet Interface	1000 Base-Tx Gigabit Ethernet Compatible
Mechanical & Environmental 	
Power Requirement	+12V
ACPI	Single Power ATX Support S0, S3, S4, S5 ACPI 1.0b and 2.0 Compliant
Power Type	AT/ ATX
Operation Temperature	0 ~ 60°C (32 ~ 140°F)
Operating Humidity	0% ~ 90% Relative Humidity, Non-condensing
Size (L x W)	4.5" x 6.5" (115mm x 165mm)
Weight	0.4lbs (0.18kg)

1.6 Architecture Overview – Block Diagram

The following block diagram shows the architecture and main components of EPI-QM57.

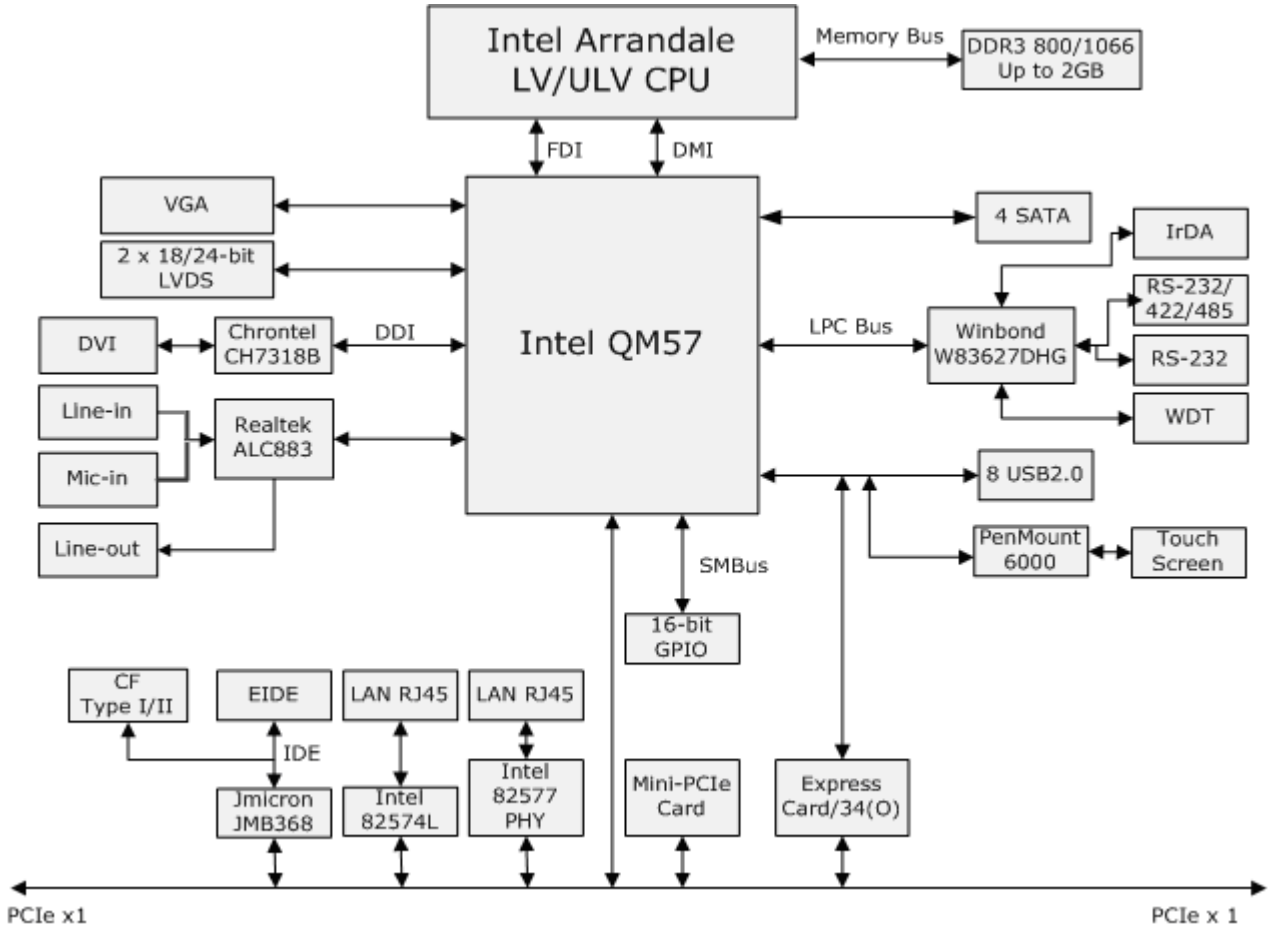

2. Hardware Configuration

2.1 Product Overview

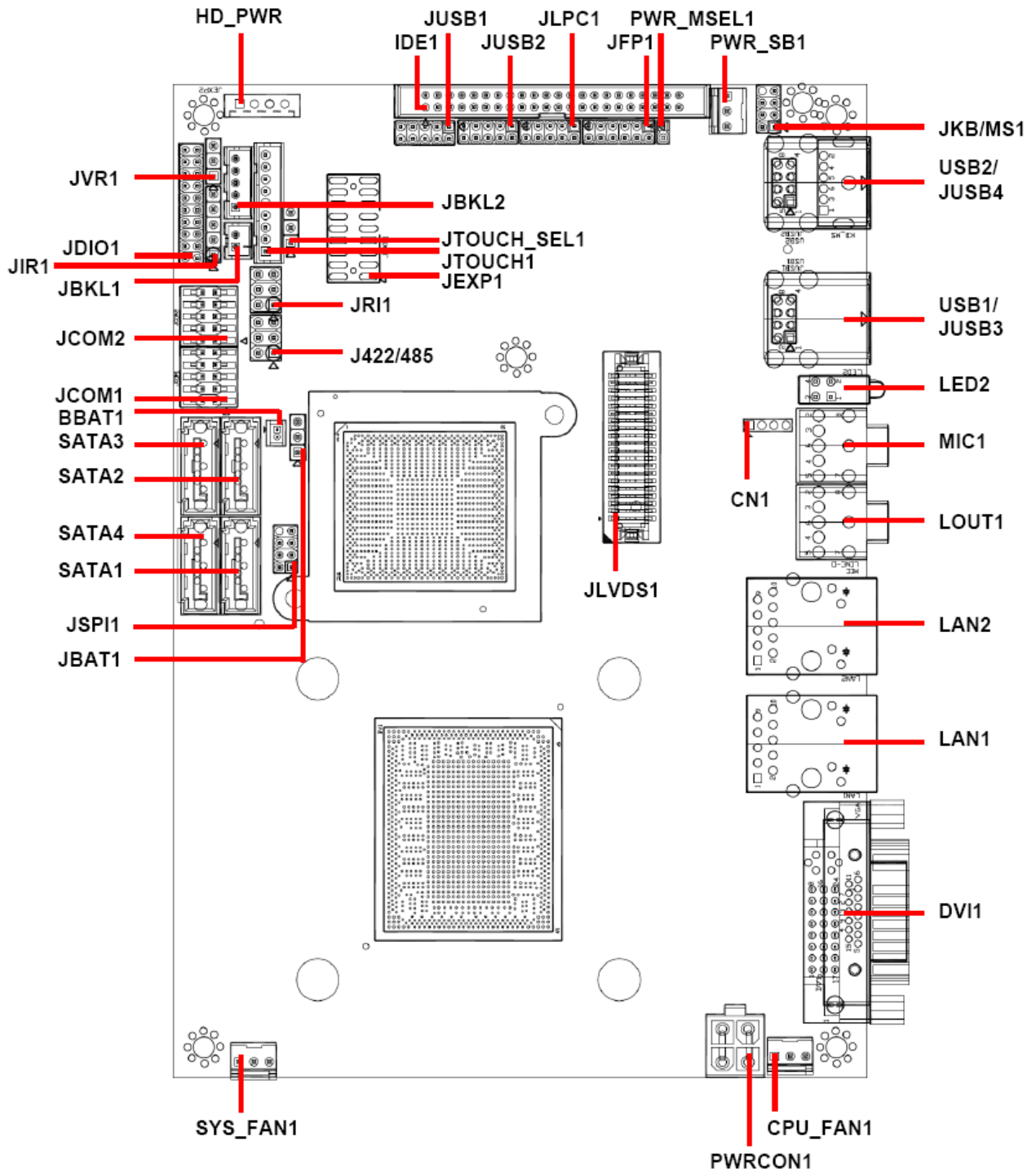

2.2 Installation Procedure

This chapter explains you the instructions of how to setup your system.

1. Turn off the power supply.
2. Insert the SODIMM module (be careful with the orientation).
3. Insert all external cables for hard disk, floppy, keyboard, mouse, USB etc. except for flat panel. A CRT monitor must be connected in order to change CMOS settings to support flat panel.
4. Connect power supply to the board via the ATXPWR.
5. Turn on the power.
6. Enter the BIOS setup by pressing the delete key during boot up. Use the "LOAD BIOS DEFAULTS" feature. The **Integrated Peripheral Setup** and the **Standard CMOS Setup** Window must be entered and configured correctly to match the particular system configuration.
7. If TFT panel display is to be utilized, make sure the panel voltage is correctly set before connecting the display cable and turning on the power.



Note: Make sure the heat sink and the CPU top surface are in total contact to avoid CPU overheating problem that would cause the system to hang or unstable

EPI-QM57

2.2.1 Main Memory

EPI-QM57 provides one 204-pin SODIMM non-ECC socket support up to DDR3 800/ 1066 SDRAM. The total maximum memory size is 4GB.

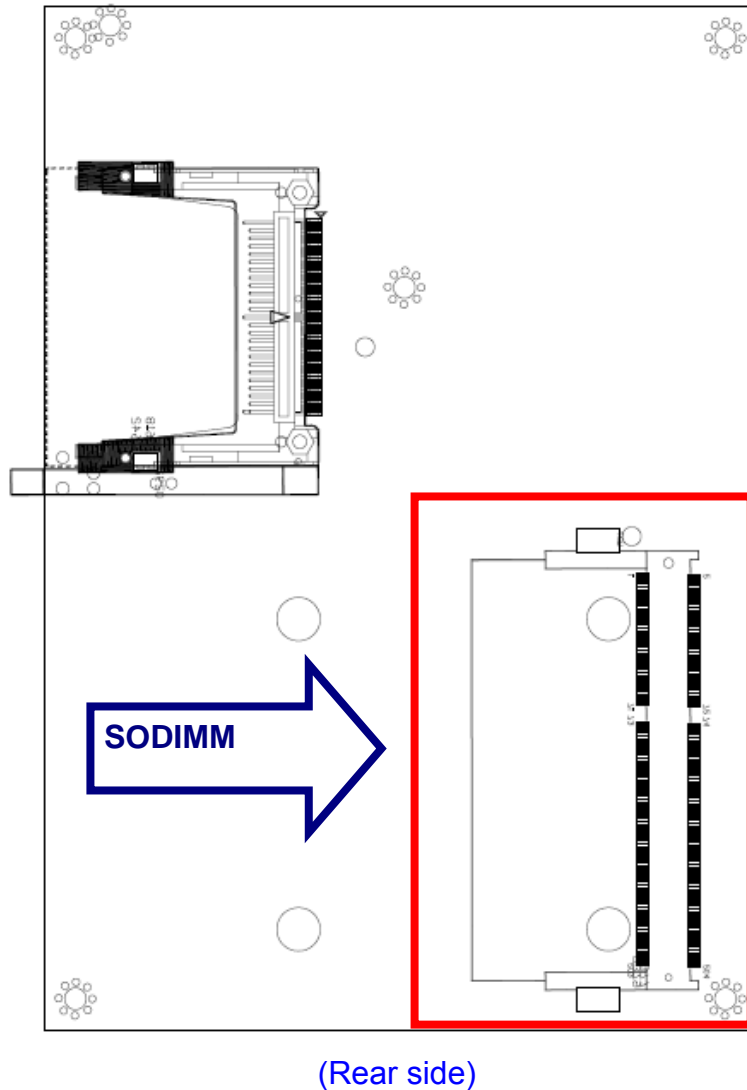

Make sure to unplug the power supply before adding or removing SODIMMs or other system components. Failure to do so may cause severe damage to both the board and the components.

- Locate the SODIMM socket on the board.
- Hold two edges of the SODIMM module carefully. Keep away of touching its connectors.
- Align the notch key on the module with the rib on the slot.
- Firmly press the modules into the socket automatically snaps into the mounting notch. Do not force the SODIMM module in with extra force as the SODIMM module only fit in one direction.

Mounting Notch Notch Key

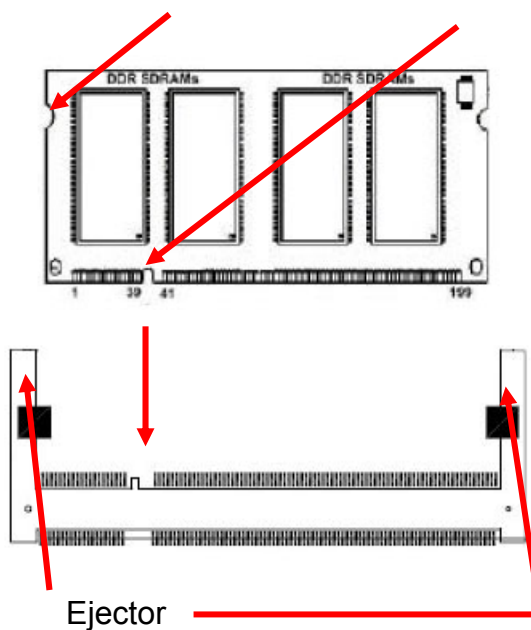

204-pin DDR3 SODIMM

- To remove the SODIMM modules, push the two ejector tabs on the slot outward simultaneously, and then pull out the SODIMM module.



Note:

- (1) Please do not change any DDR3 SDRAM parameter in BIOS setup to increase your system's performance without acquiring technical information in advance.
- (2) Static electricity can damage the electronic components of the computer or optional boards. Before starting these procedures, ensure that you are discharged of static electricity by touching a grounded metal object briefly.

2.3 Jumper and Connector List

You can configure your board to match the needs of your application by setting jumpers. A jumper is the simplest kind of electric switch.

It consists of two metal pins and a small metal clip (often protected by a plastic cover) that slides over the pins to connect them. To “close” a jumper you connect the pins with the clip. To “open” a jumper you remove the clip. Sometimes a jumper will have three pins, labeled 1, 2, and 3. In this case, you would connect either two pins.

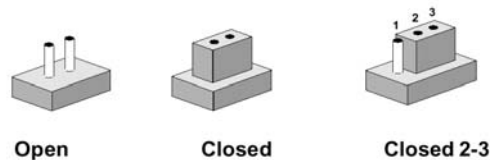

The jumper settings are schematically depicted in this manual as follows:



A pair of needle-nose pliers may be helpful when working with jumpers.

Connectors on the board are linked to external devices such as hard disk drives, a keyboard, or floppy drives. In addition, the board has a number of jumpers that allow you to configure your system to suit your application.

If you have any doubts about the best hardware configuration for your application, contact your local distributor or sales representative before you make any changes.

The following tables list the function of each of the board’s jumpers and connectors.

Jumpers

Label	Function	Note
JBAT1	Clear CMOS	3 x 1 header, pitch 2.54mm
JFP1	Miscellaneous setting connector	6 x 2 header, pitch 2.0mm
JRI1	Serial port 1 - Ring, +5V, +12V power select	3 x 2 header, pitch 2.54mm
JTOUCH_SEL1	Touch panel connector	3 x 1 header, pitch 2.54mm
PWR_MSEL1	AT/ATX mode select	2 x 1 wafer, pitch 2.0mm

Connectors

Label	Function	Note
BBAT1	Battery connector	2 x 1 wafer, pitch 1.25mm
CN1	Audio connector	4 x 1 header, pitch 2.0mm
CPU_FAN1	CPU Fan connector	3 x 1 wafer, pitch 2.54mm
HD_PWR	HD power connector	4 x 1 wafer, pitch 2.50mm
IDE1	Primary IDE connector	22 x 2 header, pitch 2.0mm
J422/485	Serial port 2 in RS-422/485 mode	3 x 2 header, pitch 2.54mm
JBKL1	LCD Inverter connector 1	2 x 1 wafer, pitch 2.0mm
JBKL2	LCD Inverter connector 2	5 x 1 wafer, pitch 2.0mm
JCOM1	Serial port 1 connector	5 x 2 header, pitch 2.0mm
JCOM2	Serial port 2 connector	5 x 2 header, pitch 2.0mm
JDIO1	General purpose I/O connector	10 x 2 header, pitch 2.0mm
JEXP1	(For Express Card Daughter Board Use)	9 x 2 header, pitch 2.0mm
JIR1	IrDA connector	5 x 1 header, pitch 2.54mm
JKB/MS1	PS/2 keyboard & mouse connector	4 x 2 header, pitch 2.0mm
JLPC1	(Reversed for BIOS programming)	5 x 2 header, pitch 2.0mm
JLVDS1	LVDS connector	DIN 40-pin wafer, pitch 1.25mm
JSPI1	SPI connector	4 x 2 header, pitch 2.0mm
JTOUCH1	Touch panel connector	9 x 1 wafer, pitch 2.0mm
JUSB1	USB connector 4 & 5	5 x 2 header, pitch 2.0mm
JUSB2	USB connector 6 & 7	5 x 2 header, pitch 2.0mm
LAN1	RJ-45 Ethernet connector	
LAN2	RJ-45 Ethernet connector	
LED2	Power & HDD indicator	
LOUT1	Audio out connector	
MIC1	MIC connector	
PWR_SB1	5VSB connector in ATX	3 x 1 wafer, pitch 2.54mm
PWRCON1	Power connector	2 x 2 wafer, pitch 4.2mm
SATA1	Serial ATA connector 1	
SATA2	Serial ATA connector 2	
SATA3	Serial ATA connector 3	
SATA4	Serial ATA connector 4	
SYS_FAN1	System Fan connector	3 x 1 wafer, pitch 2.54mm
VGA1	VGA connector	

2.4 Setting Jumpers & Connectors

2.4.1 Clear CMOS (JBAT1)

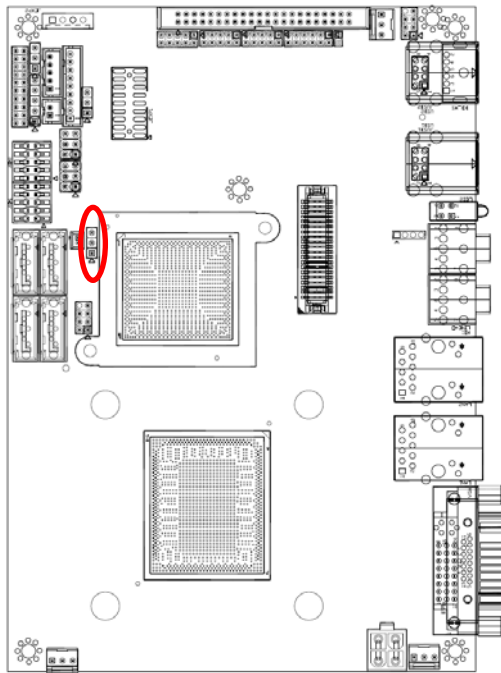

Protect*

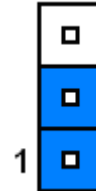

COMS



*Default

2.4.2 Serial port 1 - Ring, +5V, +12V power select (JR11)

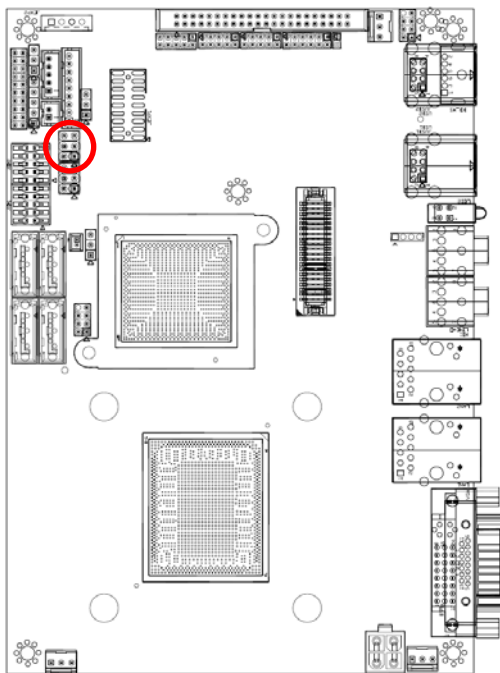

+5V

Ring*

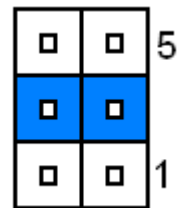
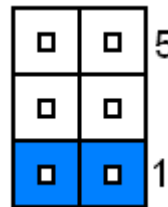

+12V

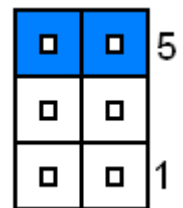

* Default

2.4.3 Miscellaneous setting connector (JFP1)

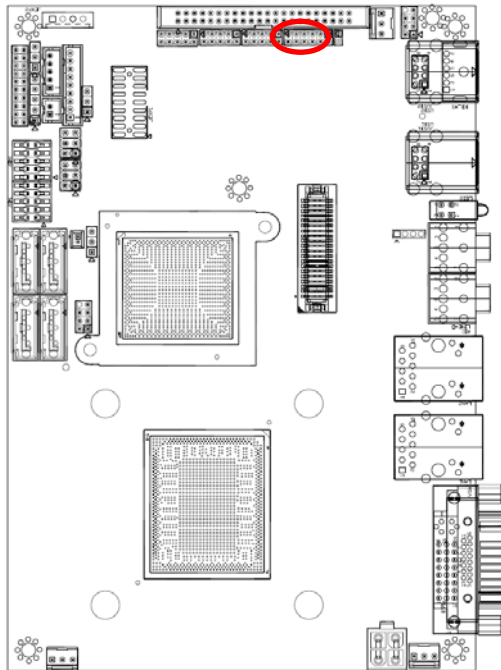

*Default

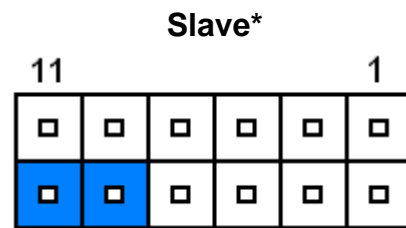
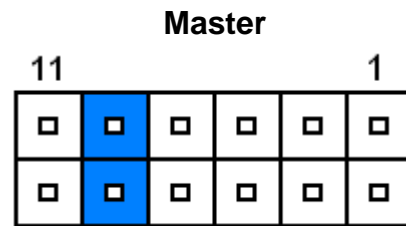

Signal	PIN
PWBT	1, 2
RST#	3, 4
PWR-LED	5, 6
HDD-LED	7, 8
CF SEL Short Master	9, 10
COPEN#	11, 12

EPI-QM57

2.4.4 Touch panel connector (JTOUCH_SEL1)

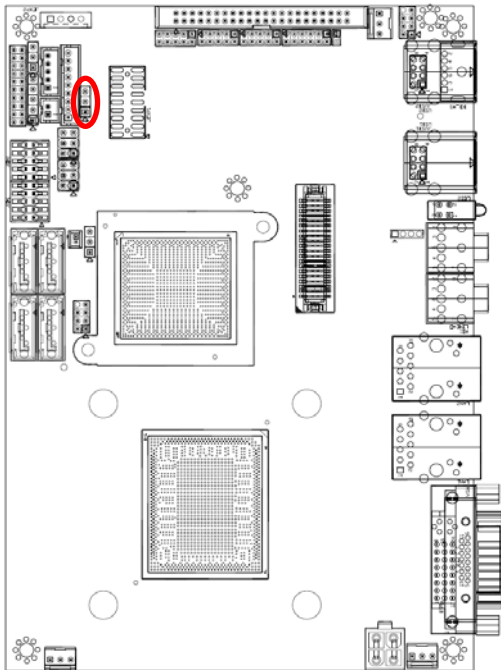

5W*



4/ 8W



* Default

2.4.5 AT/ATX mode select (PWR_MSEL1)

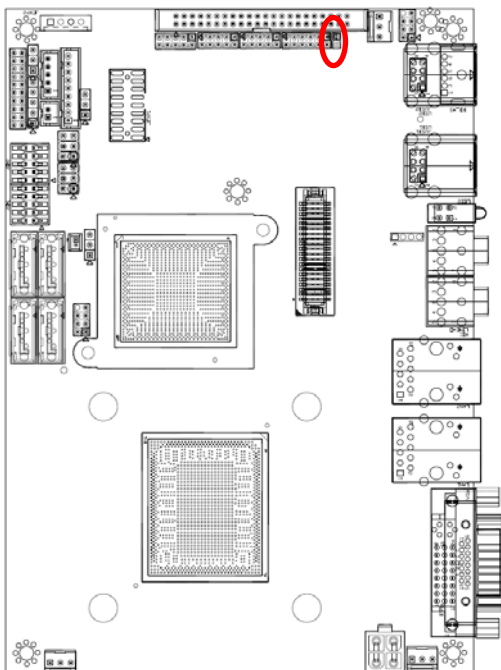

AT*

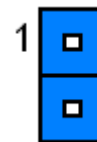

ATX



* Default

2.4.6 Battery connector (BBAT1)

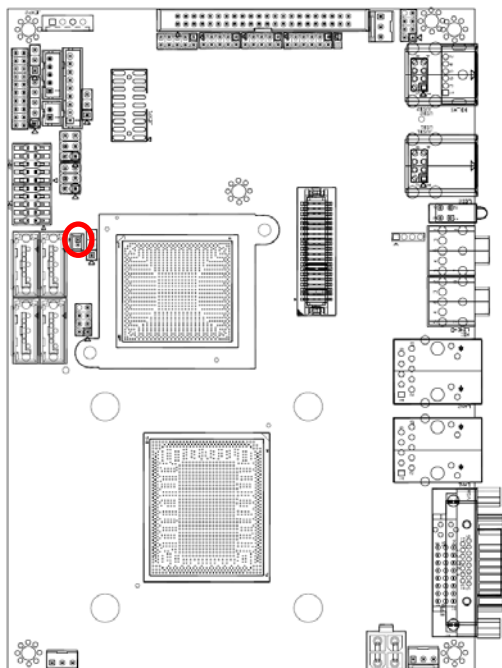

Signal	PIN
VBAT	1
GND	2

2.4.7 Audio connector (CN1)

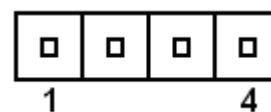
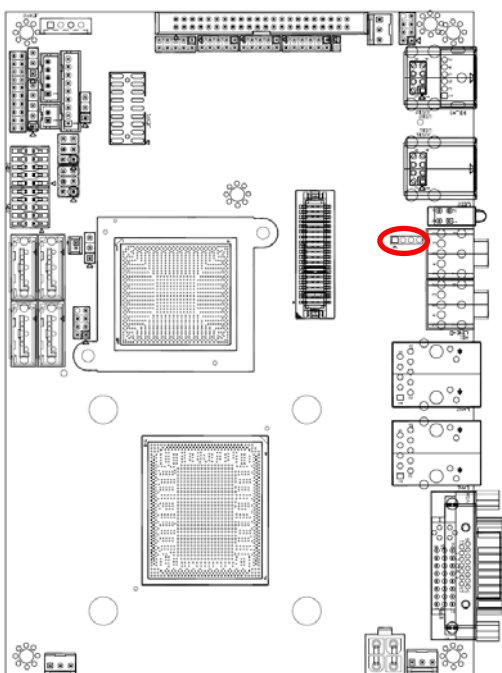

Signal	PIN
LIN1_R	1
GND	2
LIN1_JD	3
LIN1_L	4

EPI-QM57

2.4.8 CPU fan / System fan connector (CPU_FAN1/ SYS_FAN1)

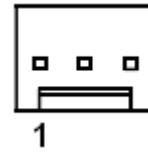
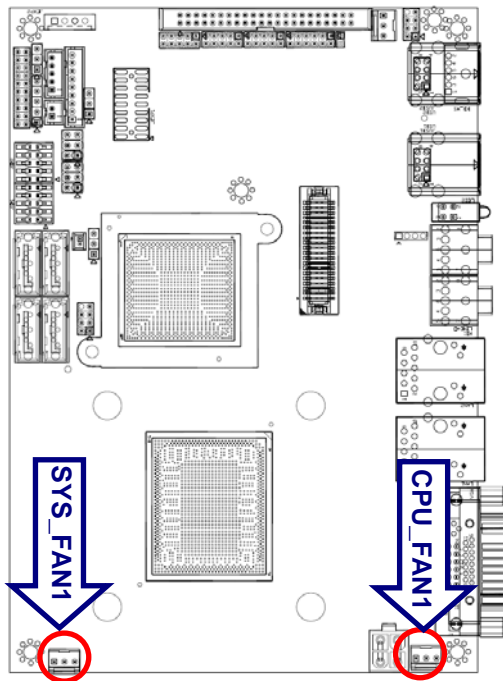

Signal	PIN
GND	1
CPU_FAN_PWR/ SYS_FAN_PWR	2
CPUFANIN/ SYSFANIN	3

2.4.9 PS/2 keyboard & mouse connector (JKB/MS1)

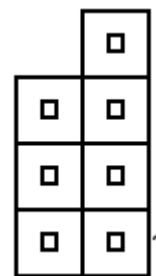
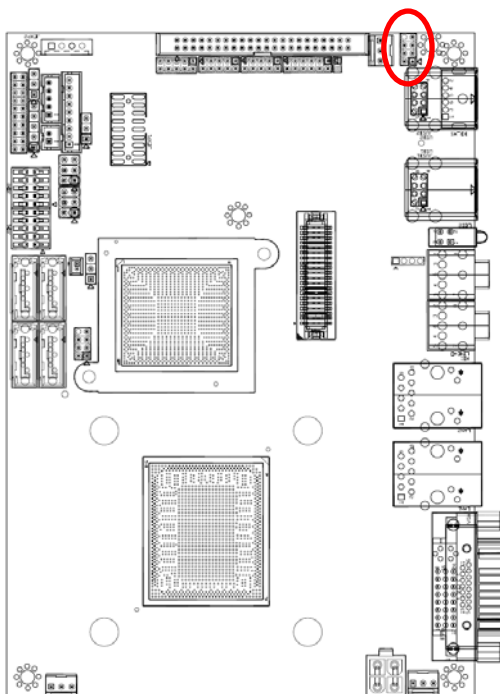

Signal	PIN	PIN	Signal
		7	NC
MCK	6	5	MDT
VDD	4	3	GND
KCK	2	1	KDT

2.4.10 Primary IDE connector (IDE1)

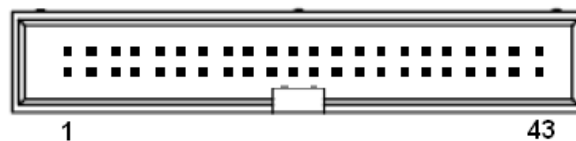
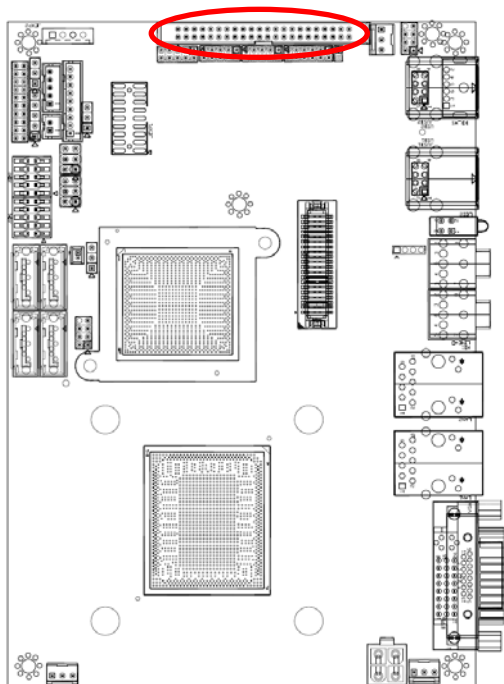

Signal	PIN	PIN	Signal
IDERST_IDE	1	2	GND
IDE_PDD7	3	4	IDE_PDD8
IDE_PDD6	5	6	IDE_PDD9
IDE_PDD5	7	8	IDE_PDD10
IDE_PDD4	9	10	IDE_PDD11
IDE_PDD3	11	12	IDE_PDD12
IDE_PDD2	13	14	IDE_PDD13
IDE_PDD1	15	16	IDE_PDD14
IDE_PDD0	17	18	IDE_PDD15
GND	19	20	NC
IDE_PDDREQ	21	22	GND
IDE_PDIOW#	23	24	GND
IDE_PDIOR#	25	26	GND
IDE_PDIORDY	27	28	PCSEL
IDE_PDDACK#	29	30	GND
INT_IRQ14	31	32	NC
IDE_PDA1	33	34	IDE_PDIAG
IDE_PDA0	35	36	IDE_PDA2
IDE_PDACS1#	37	38	IDE_PDACS3#
IDE_ACT#	39	40	GND
+5V	41	42	+5V
GND	43	44	NC

EPI-QM57

2.4.11 Serial port 2 In RS-422/485 mode connector (J422/485)

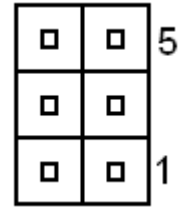
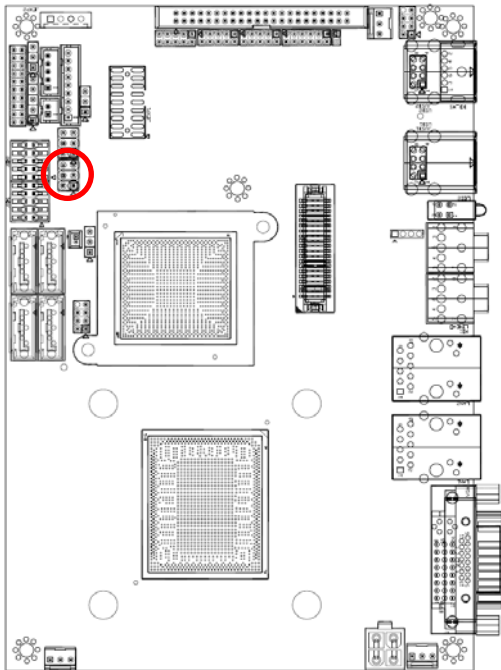

Signal	PIN	PIN	Signal
GND	6	5	+5V
RX+	4	3	TX+
RX-	2	1	TX-

 **Note:** J422/485 is available after modifying the mode of COM2 in BIOS setting.

2.4.12 HD power connector (HD_PWR)

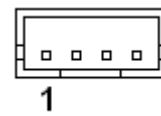
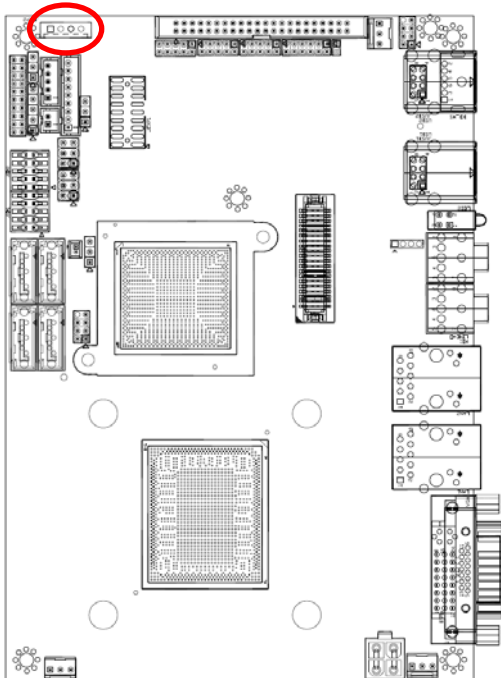

Signal	PIN
GND	1
GND	2
+5V	3
+5V	4

2.4.13 LCD Inverter Connector 1/ 2 (JBKL1/ JBKL2)

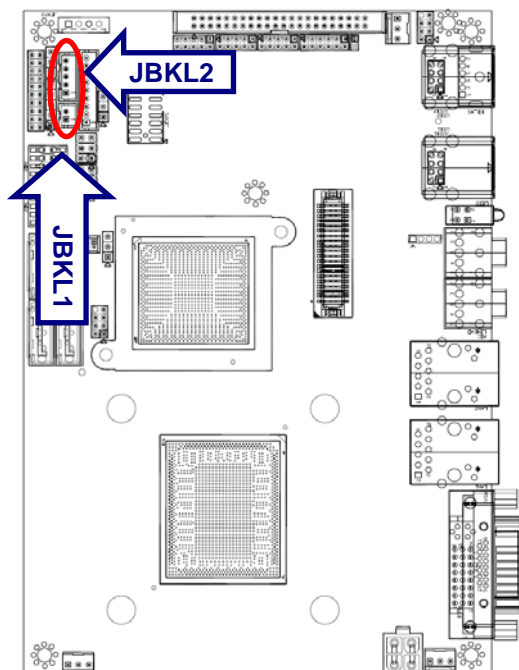

JBKL1

Signal	PIN
+12V	1
GND	2
+5V	5

JBKL2

Signal	PIN
+12V	1
GND	2
BLK_ON	3
BRIGHT	4
+5V	5

2.4.13.1 Signal Description – LCD Inverter Connector (JBKL1)

Signal	Signal Description
BRIGHT	$V_{adj} = 0.75V \sim 4.25V$ (Recommended: $4.7K\Omega, >1/16W$)
BLK_ON	LCD backlight ON/OFF control signal

EPI-QM57

2.4.14 5VSB connector in ATX (PWR_SB1)

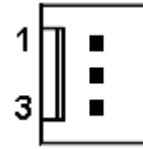
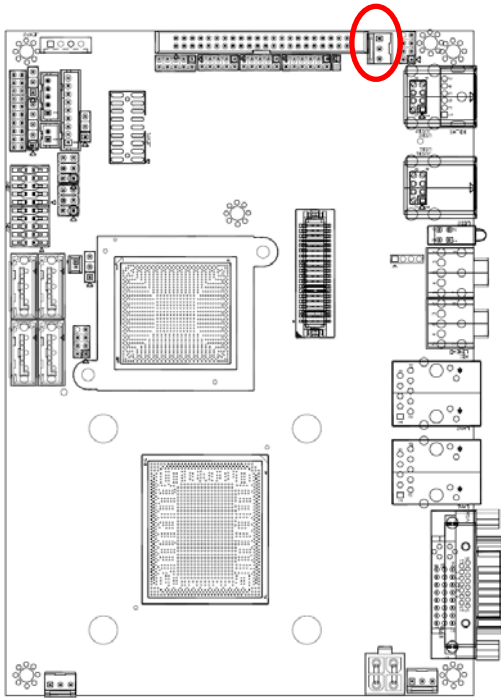

Signal	PIN
PS_ON#	1
GND	2
ATX5VSB	3

2.4.15 Serial port 1/ 2 connector (JCOM1/ JCOM2)

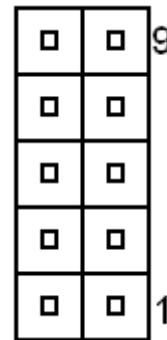
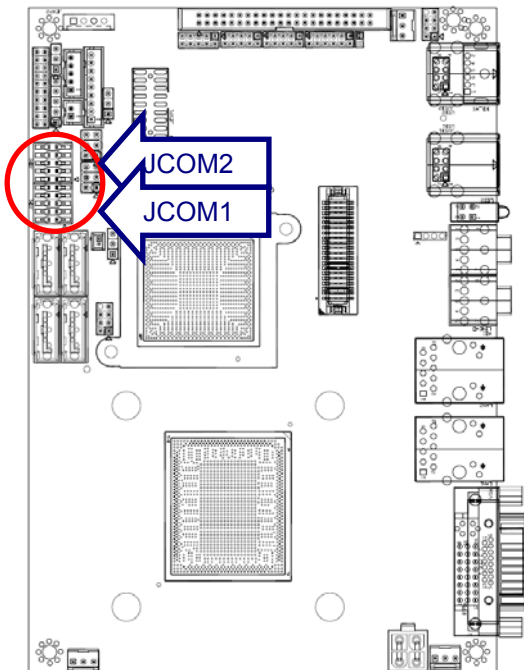

Signal	PIN	PIN	Signal
NC	10	9	RI
CTS	8	7	RTS
DSR	6	5	GND
DTR	4	3	TXDD
RXDD	2	1	DCD

2.4.16 IrDA connector (JIR1)

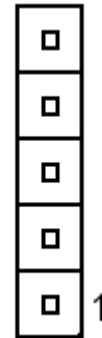
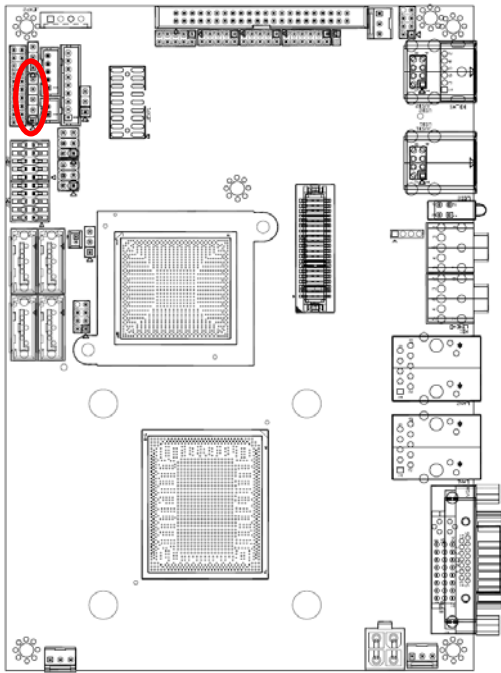

Signal	PIN
TX	5
GND	4
RX	3
NC	2
+5V	1

EPI-QM57

2.4.17 Touch panel connector (JTOUCH1)

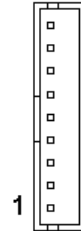
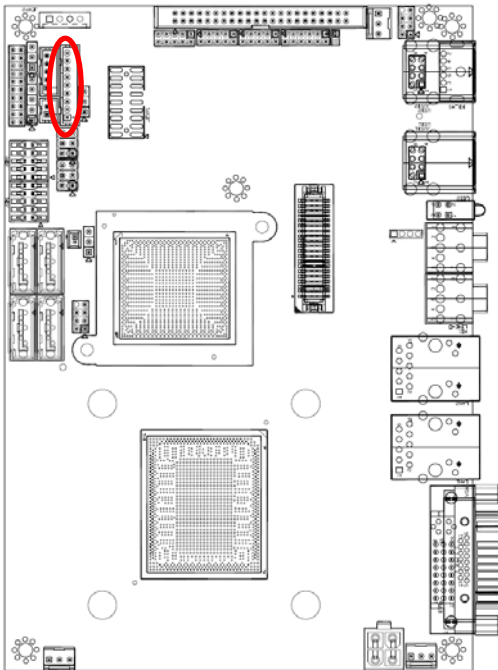

Signal	PIN
TOUCH_GND	9
Y-	8
Y+	7
X-	6
X+	5
SENSE	4
Y+	3
X-	2
X+	1

PIN	4-WIRE	5-WIRE	8-WIRE
9	GND	GND	GND
8	Top	UL	Top Excite
7	Bottom	UR	Bottom Excite
6	Left	LL	Left Excite
5	Right	LR	Right Excite
4	N/A	Sense	Top Sense
3	N/A	N/A	Bottom Sense
2	N/A	N/A	Left Sense
1	N/A	N/A	Right Sense

2.4.18 General purpose I/O connector (JDIO1)

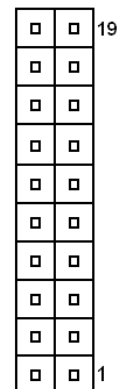
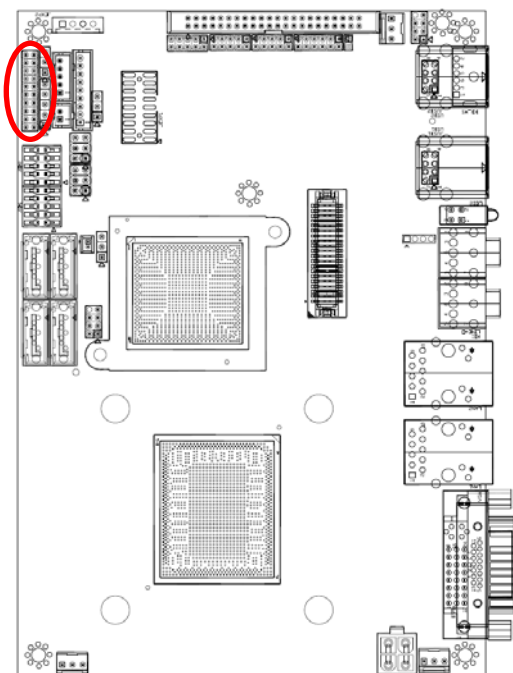

Signal	PIN	PIN	Signal
+5V	20	19	GND
SMBDATA_MAIN	18	17	SMBCLK_MAIN
DIO_GP17	16	15	DIO_GP27
DIO_GP16	14	13	DIO_GP26
DIO_GP15	12	11	DIO_GP25
DIO_GP14	10	9	DIO_GP24
DIO_GP13	8	7	DIO_GP23
DIO_GP12	6	5	DIO_GP22
DIO_GP11	4	3	DIO_GP21
DIO_GP10	2	1	DIO_GP20

EPI-QM57

2.4.19 For Express Card Daughter Board Use (JEXP1)

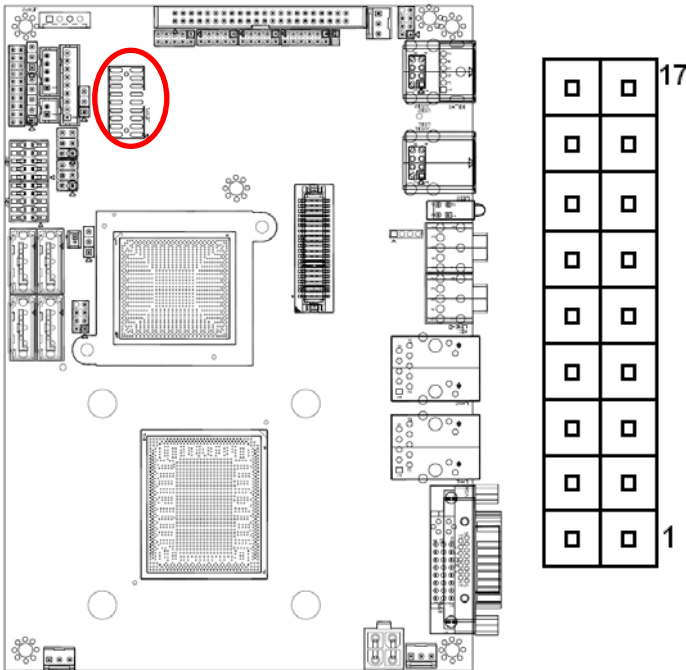

Signal	PIN	PIN	Signal
GN-2	18	17	PER-P0
PET-P0	16	15	PER-N0
PET-N0	14	13	REFCLK+
CPPE#	12	11	REFCLK-
+3.3V	10	9	PERST#
+3.3VAUX	8	7	SMBDATA
WAKE#	6	5	SMBCLK
+1.5V	4	3	USB+
GND-1	2	1	USB-

2.4.20 Power connector (PWRCON1)

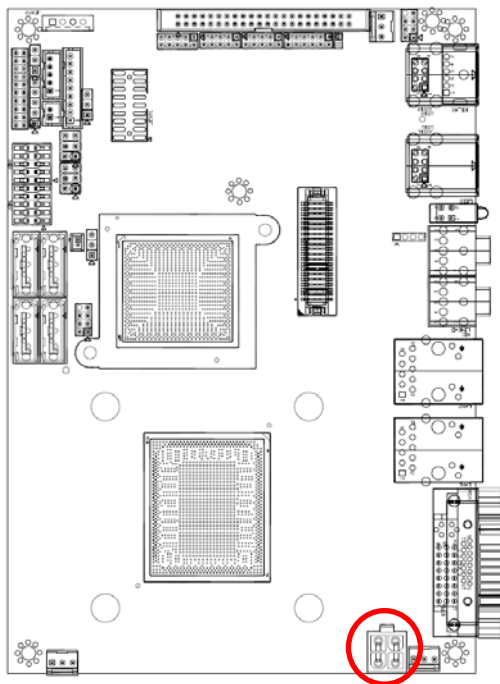

Signal	PIN	PIN	Signal
VIN	4	3	VIN
GND	2	1	GND

2.4.21 SPI connector (JSPI1)

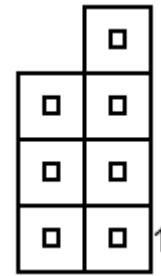
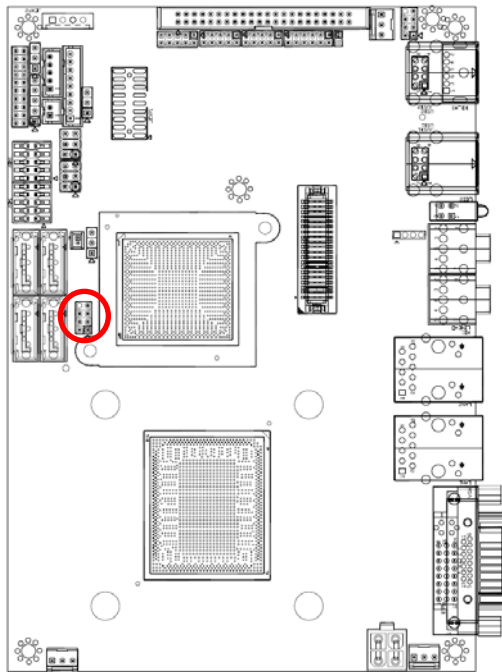

Signal	PIN	PIN	Signal
		7	HOLD#_R
SPI_SI	6	5	SPISO
SPI_CLK	4	3	SPI_CS#0
GND	2	1	+3.3V

2.4.22 USB connector 4&5/ 6&7 (JUSB1/ JUSB2)

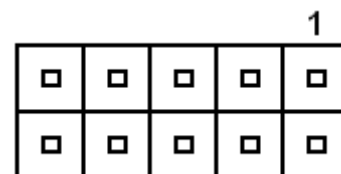
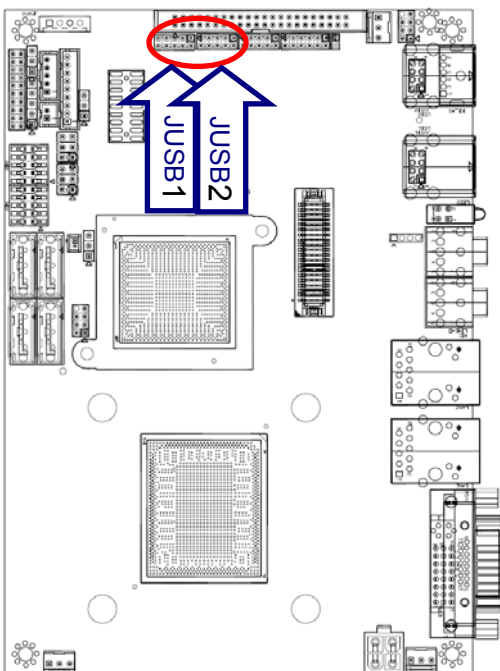

Signal	PIN	PIN	Signal
+5V	1	2	GND
USB_DN4/ 6	3	4	GND
USB_DP4/ 6	5	6	USB_DP5/ 7
GND	7	8	USB_DN5/ 7
GND	9	10	+5V

 **Note:** Wrong USB cable configuration with your USB devices might cause your USB devices damaged.

EPI-QM57

2.4.23 LVDS connector (JLVDS1)

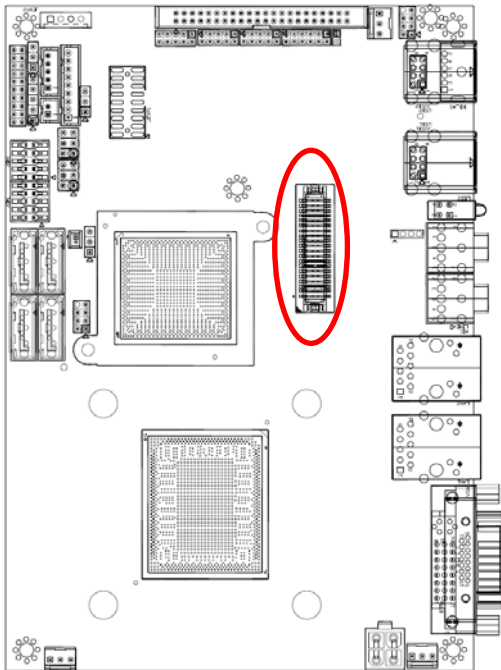

Signal	PIN	PIN	Signal
+12V	39	40	+12V
GND	37	38	GND
CLK2M	35	36	CLK1M
CLK2P	33	34	CLK1P
GND	31	32	GND
YA7M	29	30	YA6M
YA7P	27	28	YA6P
GND	25	26	GND
YA5M	23	24	YA4M
YA5P	21	22	YA4P
GND	19	20	GND
YA3M	17	18	YA2M
YA3P	15	16	YA2P
GND	13	14	GND
YA1M	11	12	YA0M
YA1P	9	10	YA0P
GND	7	8	GND
SPCLK	5	6	SPDATA
+3.3V	3	4	+5V
+3.3V	1	2	+5V

3. BIOS Setup

3.1 Introduction

The BIOS setup program allows users to modify the basic system configuration. In this following chapter will describe how to access the BIOS setup program and the configuration options that may be changed.

3.2 Starting Setup

The AMI BIOS™ is immediately activated when you first power on the computer. The BIOS reads the system information contained in the CMOS and begins the process of checking out the system and configuring it. When it finishes, the BIOS will seek an operating system on one of the disks and then launch and turn control over to the operating system.

While the BIOS is in control, the Setup program can be activated in one of two ways:

By pressing immediately after switching the system on, or

By pressing the key when the following message appears briefly at the bottom of the screen during the POST (Power On Self Test).

Press DEL to enter SETUP

If the message disappears before you respond and you still wish to enter Setup, restart the system to try again by turning it OFF then ON or pressing the "RESET" button on the system case. You may also restart by simultaneously pressing <Ctrl>, <Alt>, and <Delete> keys. If you do not press the keys at the correct time and the system does not boot, an error message will be displayed and you will again be asked to.

Press F1 to Continue, DEL to enter SETUP

3.3 Using Setup

In general, you use the arrow keys to highlight items, press <Enter> to select, use the PageUp and PageDown keys to change entries, press <F1> for help and press <Esc> to quit. The following table provides more detail about how to navigate in the Setup program using the keyboard.

Button	Description
↑	Move to previous item
↓	Move to next item
←	Move to the item in the left hand
→	Move to the item in the right hand
Esc key	Main Menu -- Quit and not save changes into CMOS Status Page Setup Menu and Option Page Setup Menu -- Exit current page and return to Main Menu
PgUp key	Increase the numeric value or make changes
PgDn key	Decrease the numeric value or make changes
+ key	Increase the numeric value or make changes
- key	Decrease the numeric value or make changes
F1 key	General help, only for Status Page Setup Menu and Option Page Setup Menu
(Shift) F2 key	Change color from total 16 colors. F2 to select color forward, (Shift) F2 to select color backward
F3 key	Calendar, only for Status Page Setup Menu
F4 key	Reserved
F5 key	Restore the previous CMOS value from CMOS, only for Option Page Setup Menu
F6 key	Load the default CMOS value from BIOS default table, only for Option Page Setup Menu
F7 key	Load the default
F8 key	Reserved
F9 key	Reserved
F10 key	Save all the CMOS changes, only for Main Menu

- **Navigating Through The Menu Bar**

Use the left and right arrow keys to choose the menu you want to be in.



Note: Some of the navigation keys differ from one screen to another.

- **To Display a Sub Menu**

Use the arrow keys to move the cursor to the sub menu you want. Then press <Enter>. A "➤" pointer marks all sub menus.

3.4 Getting Help

Press F1 to pop up a small help window that describes the appropriate keys to use and the possible selections for the highlighted item. To exit the Help Window press <Esc> or the F1 key again.

3.5 In Case of Problems

If, after making and saving system changes with Setup, you discover that your computer no longer is able to boot, the AMI BIOS supports an override to the CMOS settings which resets your system to its defaults.

The best advice is to only alter settings which you thoroughly understand. To this end, we strongly recommend that you avoid making any changes to the chipset defaults. These defaults have been carefully chosen by both Award and your systems manufacturer to provide the absolute maximum performance and reliability. Even a seemingly small change to the chipset setup has the potential for causing you to use the override.

3.6 BIOS setup

Once you enter the AMI BIOS CMOS Setup Utility, the Main Menu will appear on the screen. The Main Menu allows you to select from several setup functions and exit choices. Use the arrow keys to select among the items and press <Enter> to accept and enter the sub-menu.

3.5.1 Main Menu

This section allows you to record some basic hardware configurations in your computer and set the system clock.

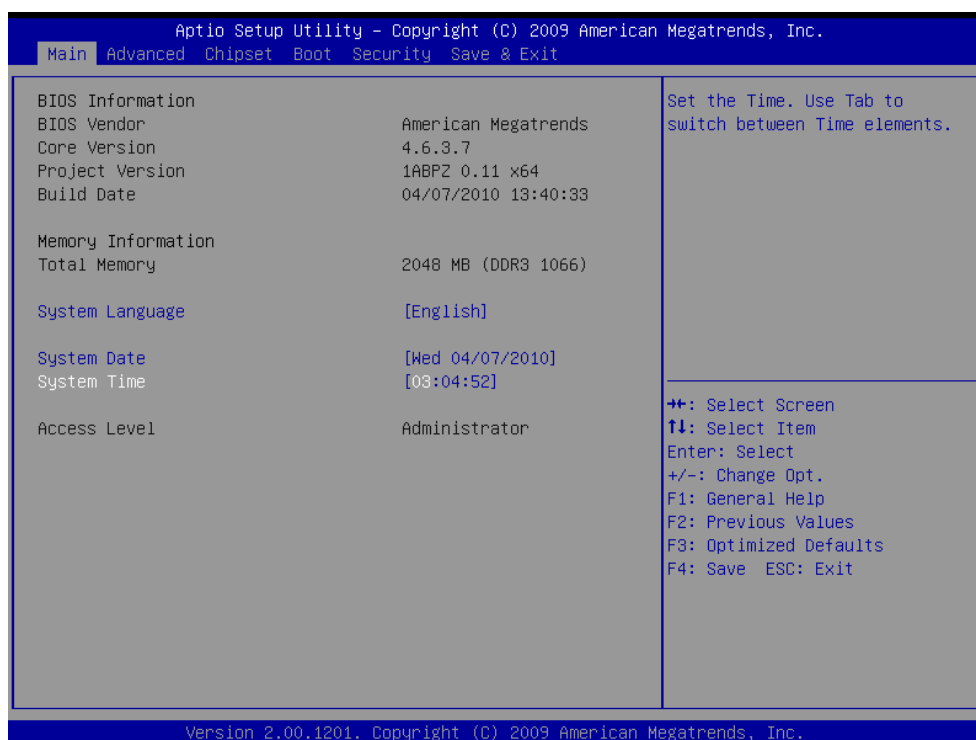

3.5.1.1 System Language

This option allows choosing the system default language.

3.5.1.2 System Date

Use the system time option to set the system time. Manually enter the hours, minutes and seconds.

EPI-QM57

3.5.1.3 System Time

Use the system Date option to set the system date. Manually enter the day, month and year.



Note: The BIOS setup screens shown in this chapter are for reference purposes only, and may not exactly match what you see on your screen. Visit the Avalue website (www.avalue.com.tw) to download the latest product and BIOS information.

3.5.2 Advanced Menu

This section allows you to configure your CPU and other system devices for basic operation through the following sub-menus.

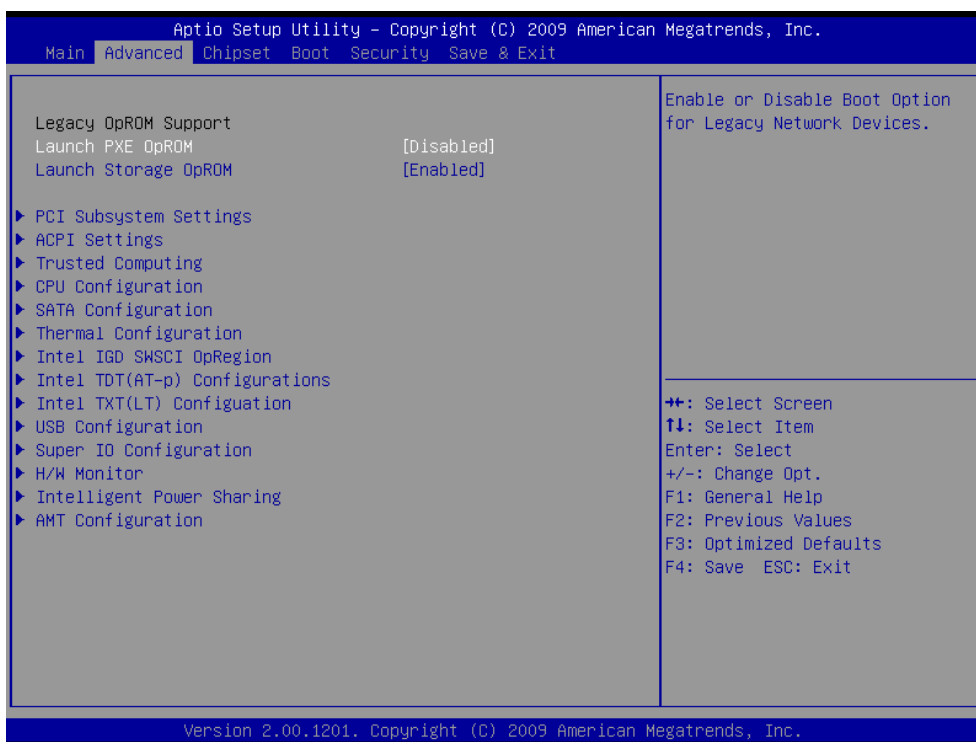

3.5.2.1 PCI subsystem Settings

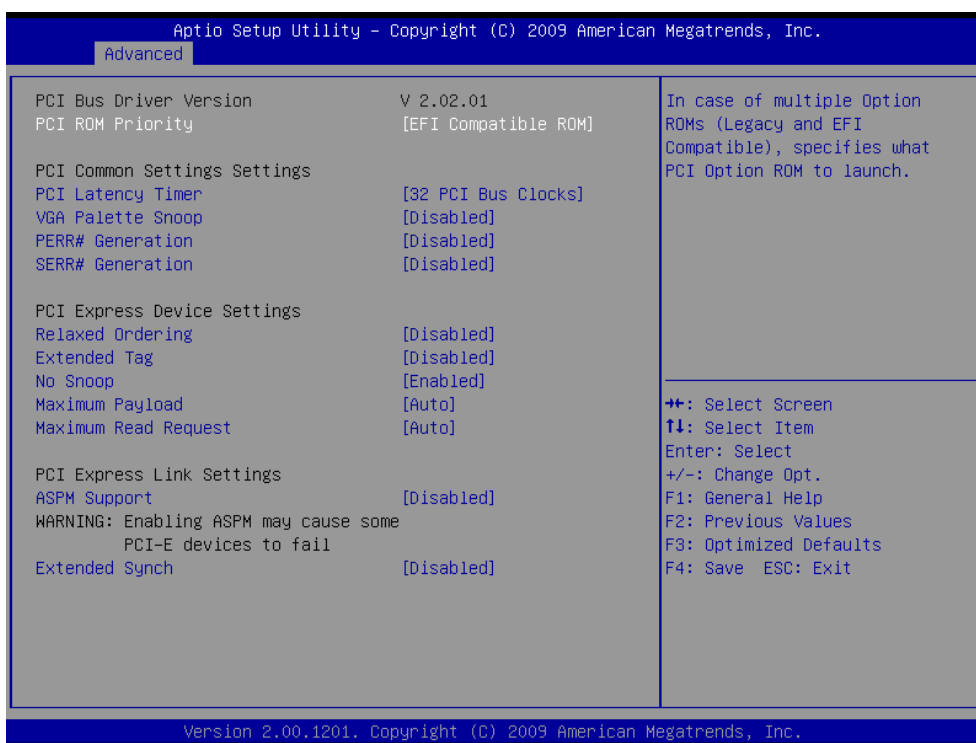

Item	Options	Description
PCI ROM Priority	Legacy ROM, EFI Compatible ROM	In case of multiple Optional ROMs (Legacy and EFI Compatible), specifies what PCI Option ROM to launch.
PCI Latency Timer	32 PCI Bus Clocks, 64 PCI Bus Clocks, 96 PCI Bus Clocks, 128 PCI Bus Clocks, 160 PCI Bus Clocks, 192 PCI Bus Clocks, 224 PCI Bus Clocks, 248 PCI Bus Clocks	Value to be programmed into PCI Latency Register.
VGA Palette Snoop	Enable, Disable	Enable or Disable VGA Palette Registers Snooping.
PERR# Generation	Enable, Disable	If ENABLED allows generation of Extended Synchronization patterns.
SERR# Generation	Enable, Disable	Enables or Disables PCI Devices to Generate SERR#.
Relaxed Ordering	Enable, Disable	Enables or Disables PCI Express Device Relaxed Ordering.

EPI-QM57

Extended Tag	Enable, Disable	If ENABLED allows Devices to use 8-bit Tag field as a requester.
No Snoop	Enable, Disable	Enables or Disables PCI Express Devices No Snoop option.
Maximum Payload	128 Bytes, 256 Bytes, 512 Bytes, 1024 Bytes, 2048 Bytes, 4096 Bytes	Set Maximum Payload of PCI Express Device or allow System BIOS to select the value.
Maximum Read Request	128 Bytes, 256 Bytes, 512 Bytes, 1024 Bytes, 2048 Bytes, 4096 Bytes	Set Maximum Read Request Size of PCI Express Device or allow System BIOS to select the value.
ASPM Support	Disable, Auto, Force L0	Set the ASPM Level: Force L0 – Force all links to L0 State: Auto – BIOS auto configure: DISABLE – Disables ASPM
Extended Synch	Enable, Disable	If ENABLED allows generation of Extended Synchronization patterns.

3.5.2.2 ACPI Settings

You can use this item to set up ACPI Configuration.

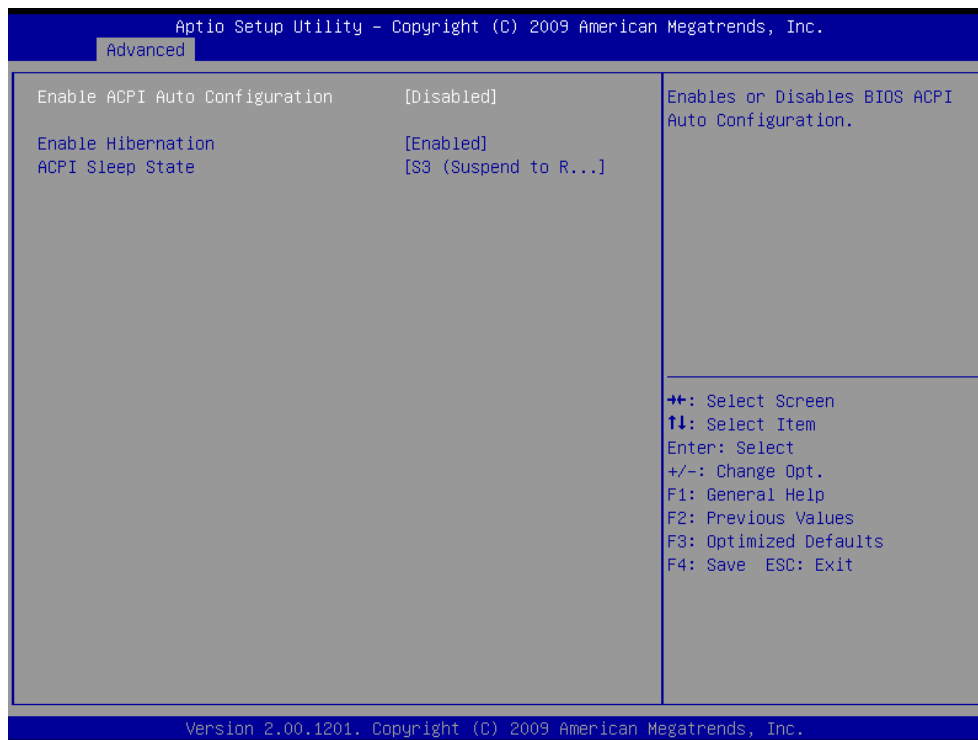

Item	Options	Description
Enable ACPI Auto Configuration	Disabled, Enabled	Enables or Disables BIOS ACPI Auto Configuration.
Enable Hibernation	Disabled, Enabled	Enables or Disables System ability to Hibernate (OS/S4 Sleep State). This option may be not effective with some OS.
ACPI Sleep State	Suspend Disable, S1 (CUP Stop Clock), S3 (Suspend to RAM)	Select the highest ACPI sleep state the system will enter, when the SUSPEND button is pressed.

EPI-QM57

3.5.2.3 CPU Configuration

Use the CPU configuration menu to view detailed CPU specification and configure the CPU.

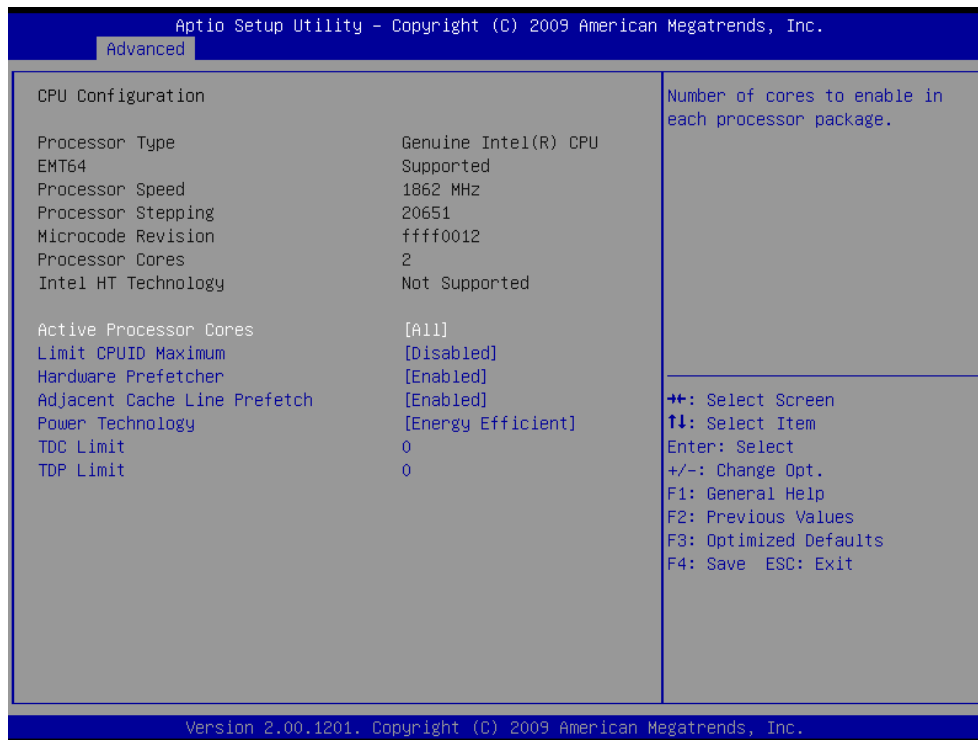

Item	Options	Description
Active Processor Cores	All, 1, 2	Number of cores to enable in each processor package.
Limit CPUID Maximum	Disabled, Enabled	Disable for Windows XP.
Hardware Prefetcher	Disabled, Enabled	To turn on/ off the MLC streamer prefetcher.
Adjacent Cache Line Prefetch	Disabled, Enabled	To turn on/ off prefetching of adjacent cache lines.
Power Technology	Disabled, Energy Efficient, Custom	Enable the power management features.
TDC Limit	0	Turbo-XE Mode Processor TDC Limit in 1/8 A granularity. 0 means using the factory-configured value.
TDP Limit	0	Turbo-XE Mode Processor TDP Limit in 1/8 W granularity. 0 means using the factory-configured value.

3.5.2.4 SATA Configuration

It allows you to select the operation mode for SATA controller.

The choices:

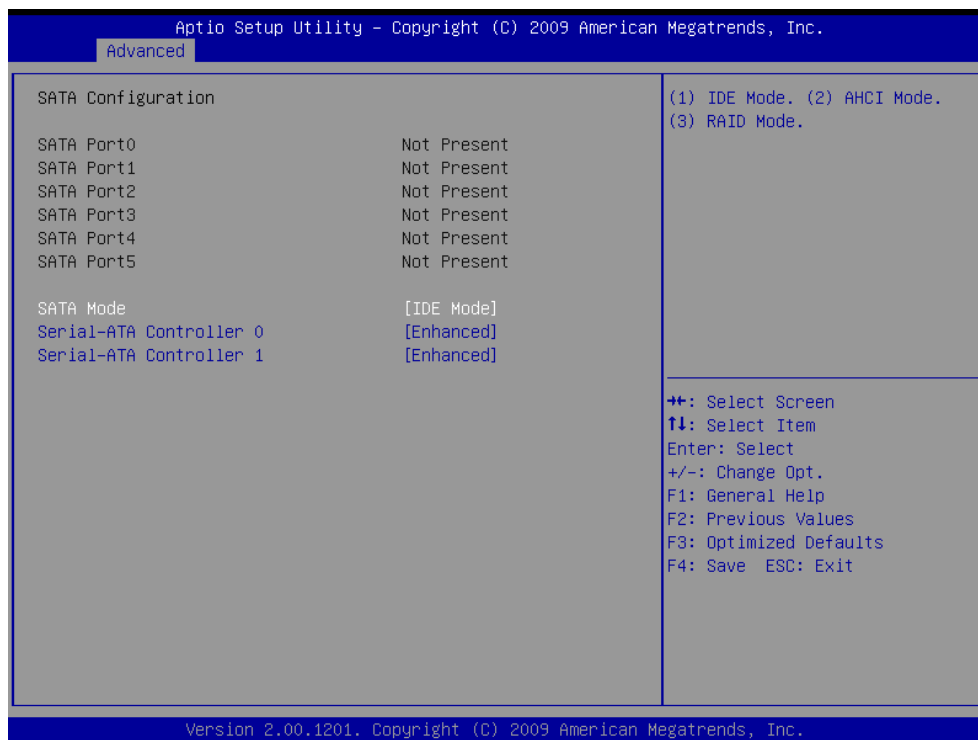

Item	Option	Description
SATA mode	Disable, IDE mode, AHCI mode, RAID mode	It allows you to select the operation mode for SATA controller.
Serial-ATA Controller 0	Disable, Enhanced, Compatible	Enable/ Disable Serial ATA Controller 0.
Serial-ATA Controller 1	Disable, Enhanced	Enable/ Disable Serial ATA Controller 0.

3.5.2.5 Thermal Configuration

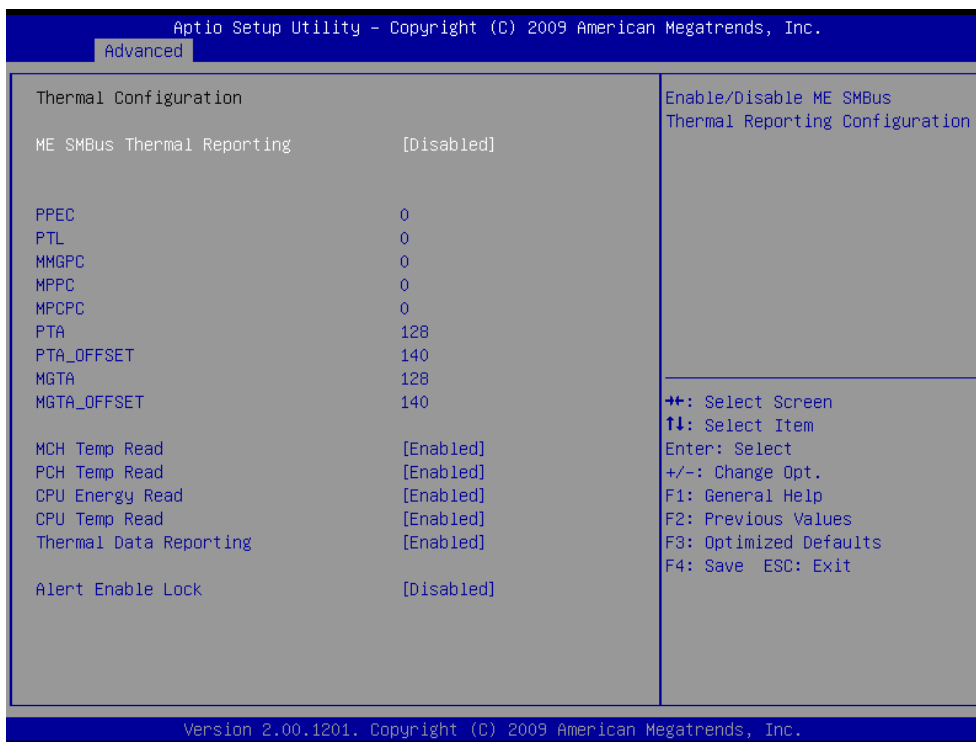

Item	Option	Description
ME SMBus Thermal Reporting	Disabled, Enabled	Enable/ Disable ME SMBus Thermal Reporting Configuration.
PPEC	0	Processor Power Error Correction.
PTL	0	Processor Temperature Limit.
MMGPC	0	Max Memory Power.
MPPC	0	Max Processor Power Clamp.
MPCPC	0	Max Processor Core Power Clamp.
PTA	128	PCH Temperature Adjust.
PTA_OFFSET	140	PCH offset for calculating PCH Temperature.
MGTA	128	MCH/ GfX Temperature Adjust.
MGTA_OFFSET	140	MCH/ GfX offset for calculating MCH/ GfX Temperature.
MCH Temp Read	Disabled, Enabled	MCH Temperature Read Enable.
PCH Temp Read	Disabled, Enabled	PCH Temperature Read Enable.
CPU Energy Read	Disabled, Enabled	CPU Energy Read Enable.

CPU Temp Read	Disabled, Enabled	CPU Temperature Read Enable.
Thermal Data Reporting	Disabled, Enabled	Thermal Data Reporting Enable.
Alert Enable Lock	Enabled, Disabled	Lock all Alert Enable settings.

3.5.2.6 Intel IGD SWSCI OpRegion

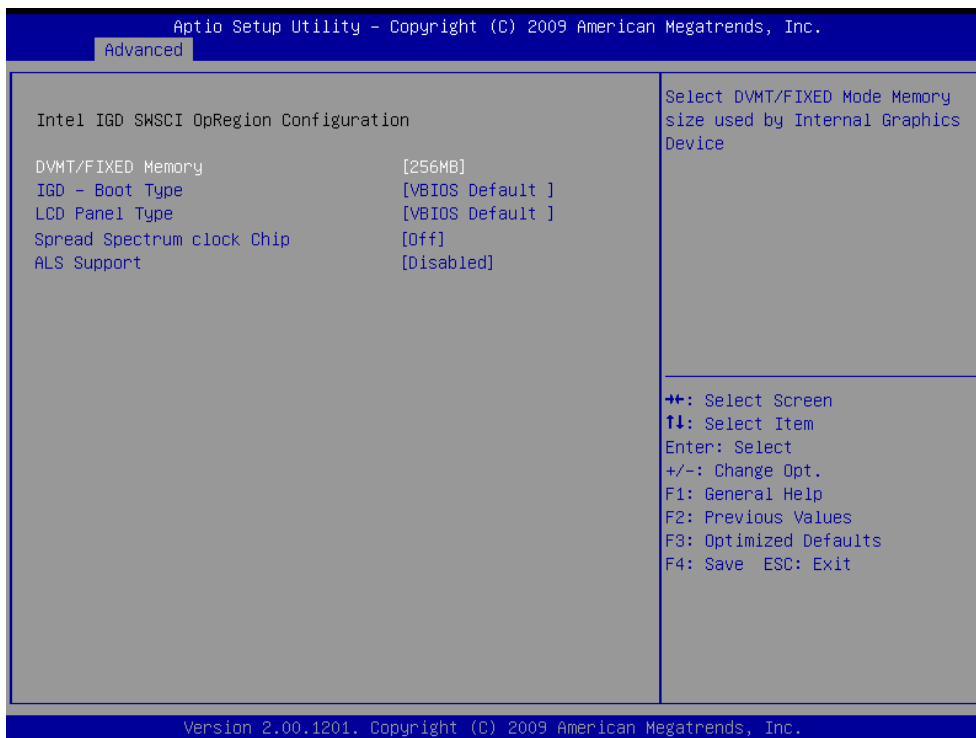

Item	Option	Description
DVMT/ Fixed Memory	256MB, 128MB, Maximum	This feature allows you to select the memory size of DVMT/BOTH operating mode.
IGD – Boot Type	VBIOS Default, CRT, LVDS, CRT+LVDS, DVI, CRT+DVI	This feature allows you to select the display device when you boot up the system.

EPI-QM57

LCD Panel Type	VBIOS Default, 640x480 18/1, 800x600 18/1, 1024x768 18/1, 1280x1024 24/2, 1024x600 18/2, 1400x900 24/2, 1600x1200 18/2, 1280x768 18/1, 1680x1050 24/2, 1920x1080 24/2, 1024x768 24/1, 1366x768 24/1, 800x400 18/1, 1280x800 18/1, 1280x720 24/1, 2048x1536 24/2	This feature allows you to select Panel Resolution that will be displayed depending on the LCD Panel.
Spread Spectrum Clock Chip	Off, Hardware, Software	Hardware: Spread is controlled by chip. Software: Spread is controlled by BIOS.
ALS Support	Enabled, Disabled	Valid only for ACPI. Legacy = ALS Support through the IGD INT10 function. ACPI = ALS support through an ACPI ALS Driver.

3.5.2.7 Intel TDT (AT-p) Configuration

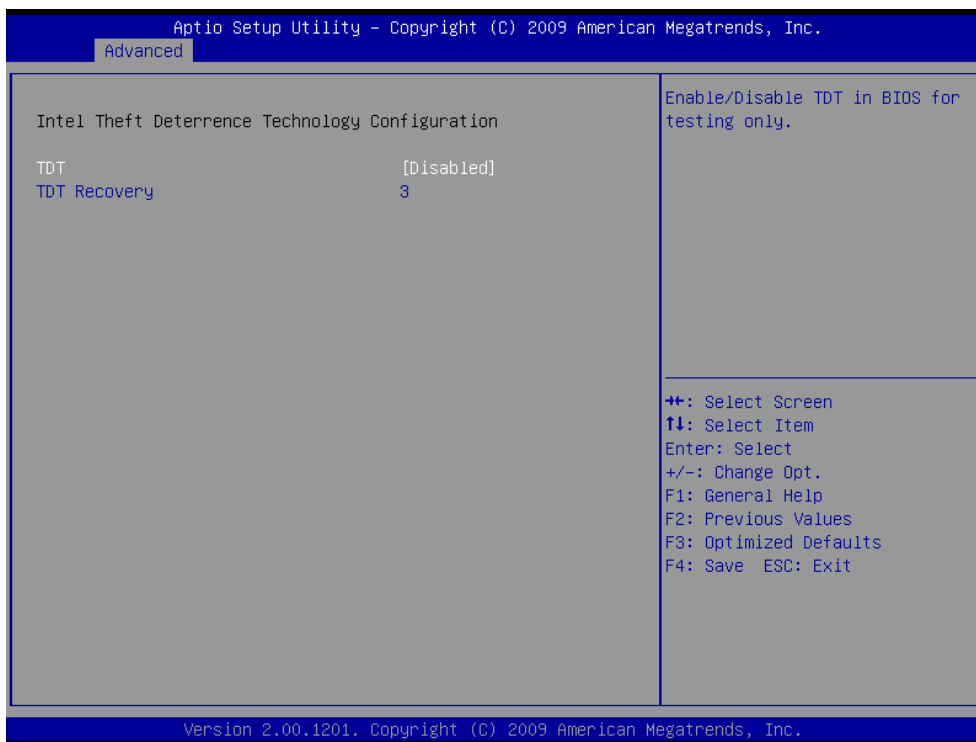

Item	Option	Description
TDT	Enabled, Disabled	Enable/ Disable TDT in BIOS for testing only.
TDT Recovery	3	Set the number of times Recovery attempted will be allowed.

EPI-QM57

3.5.2.8 Intel TXT (LT) Configuration

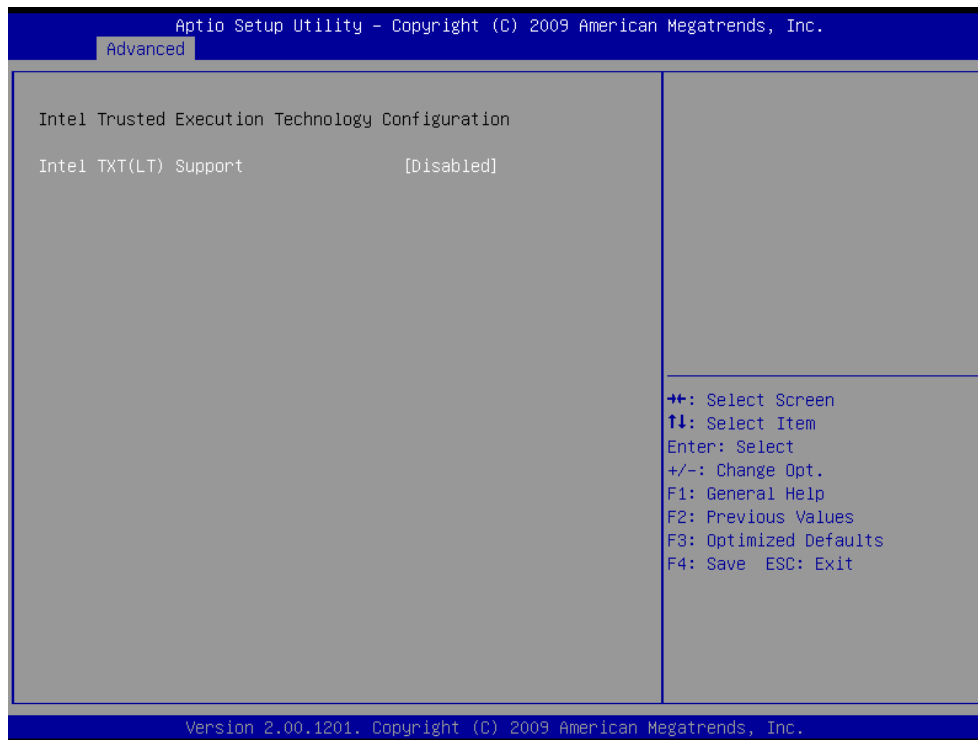

3.5.2.9 USB Configuration

The USB configuration menu is used to read USB configuration information and configure the USB setting.

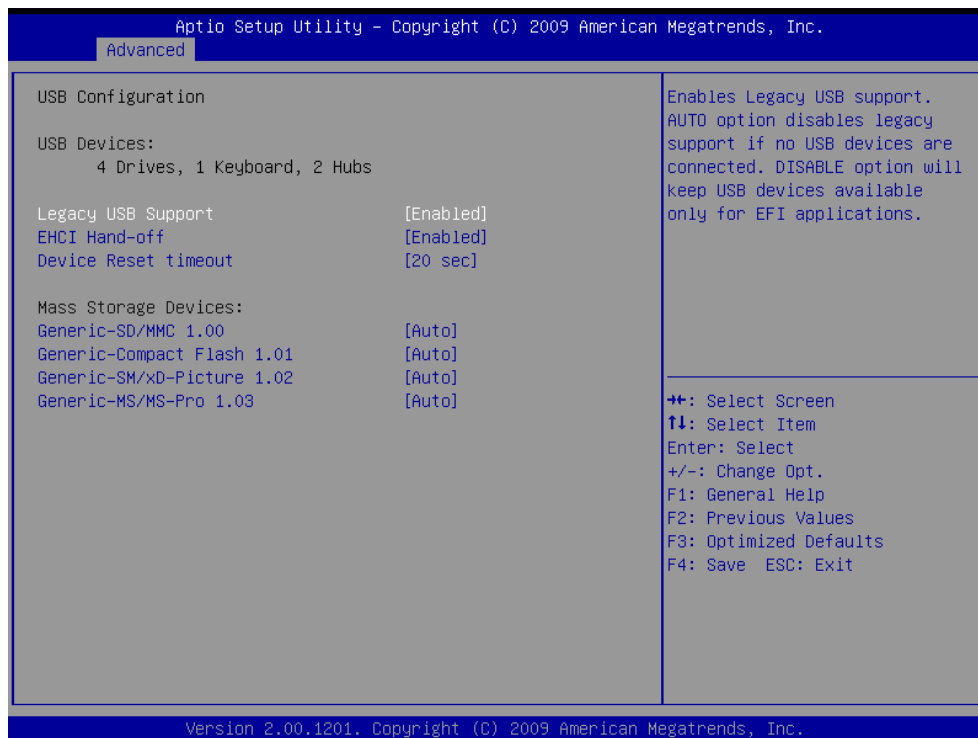

3.5.2.9.1 Legacy USB support

Use the Legacy USB Support BIOS option to enable USB mouse and USB keyboard support. Normally if this option is not enabled, any attached USB mouse or USB keyboard does not become available until a USB compatible operating system is fully booted with all USB drivers loaded. When this option is enabled, any attached USB mouse or USB keyboard can control the system even when there is no USB driver loaded onto the system. The choices: Enabled, Disabled, Auto

3.5.2.9.2 ECHI hand-off

This is a workaround for OSs without EHCI hand-off support. The EHCI ownership change should be claimed by EHCI driver. The Choices: Enabled, Disabled

3.5.2.9.3 Device Reset timeout

USB mass storage device Start Unit command timeout. The choices: 10, 20, 30, 40 sec.

3.5.2.9.4 Mass Storage Devices

This item allows you to set up mass storage devices. The choices: Auto, Floppy, Forced FDD, Hard-Disk, CD-ROM.

3.5.2.10 H/W Monitor

The H/W Monitor mean shows the operating temperature, fan speeds and system voltages.

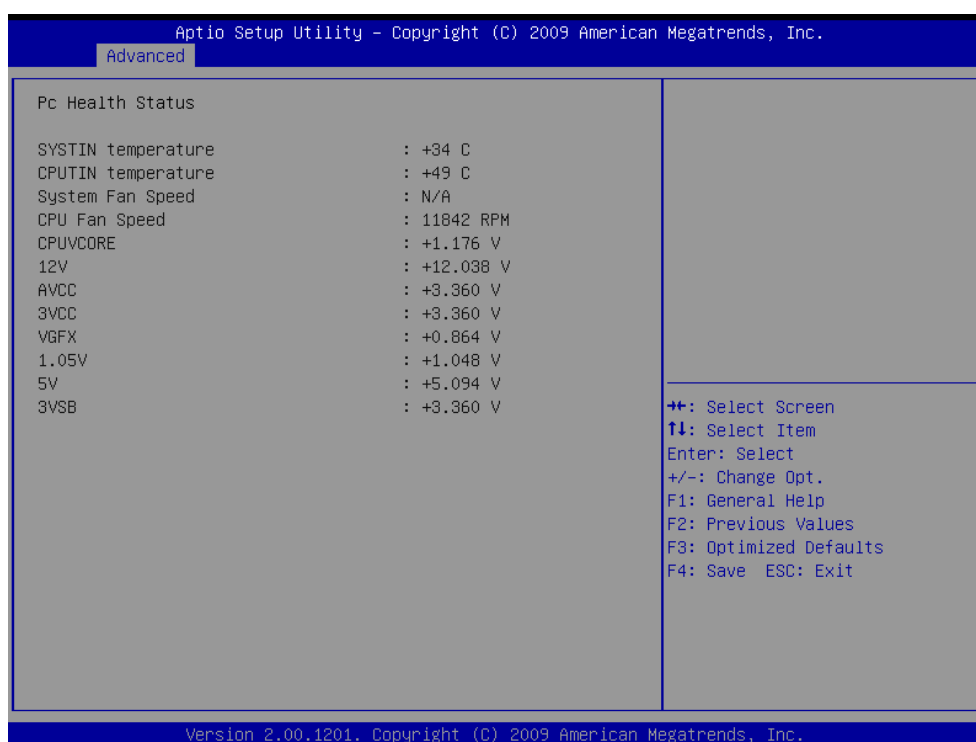

EPI-QM57

3.5.2.11 Super IO Configuration

You can use this item to set up or change the Super IO configuration for FDD controllers, parallel ports and serial ports. Please refer to 3.5.2.12.1 and 3.5.2.12.2 for more information.

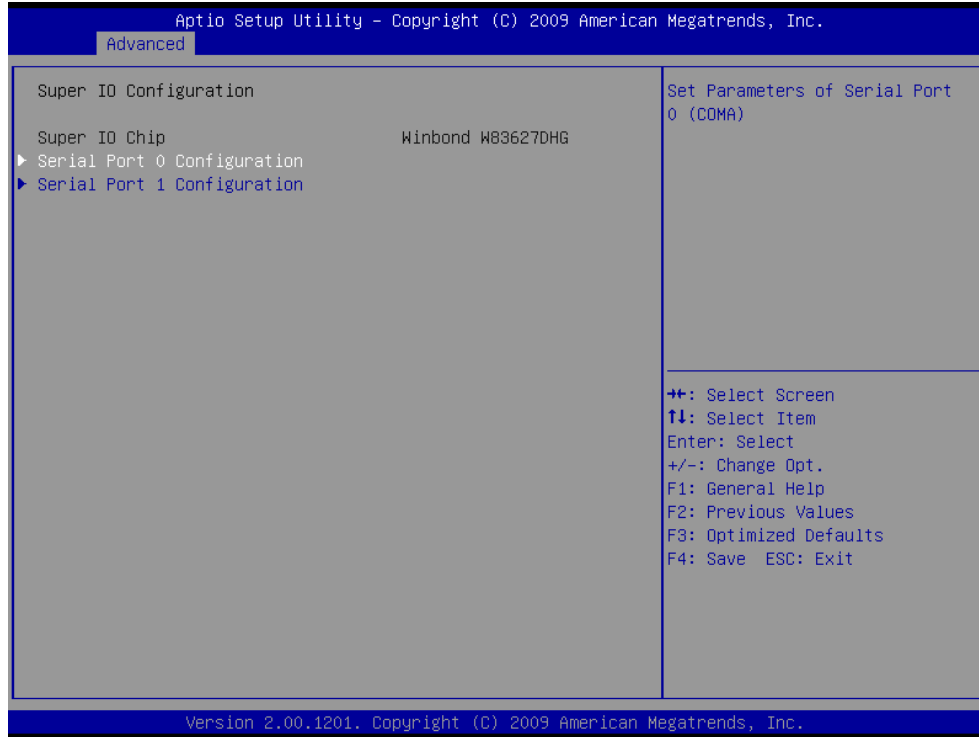

3.5.2.12.1 Serial Port 0 Configuration

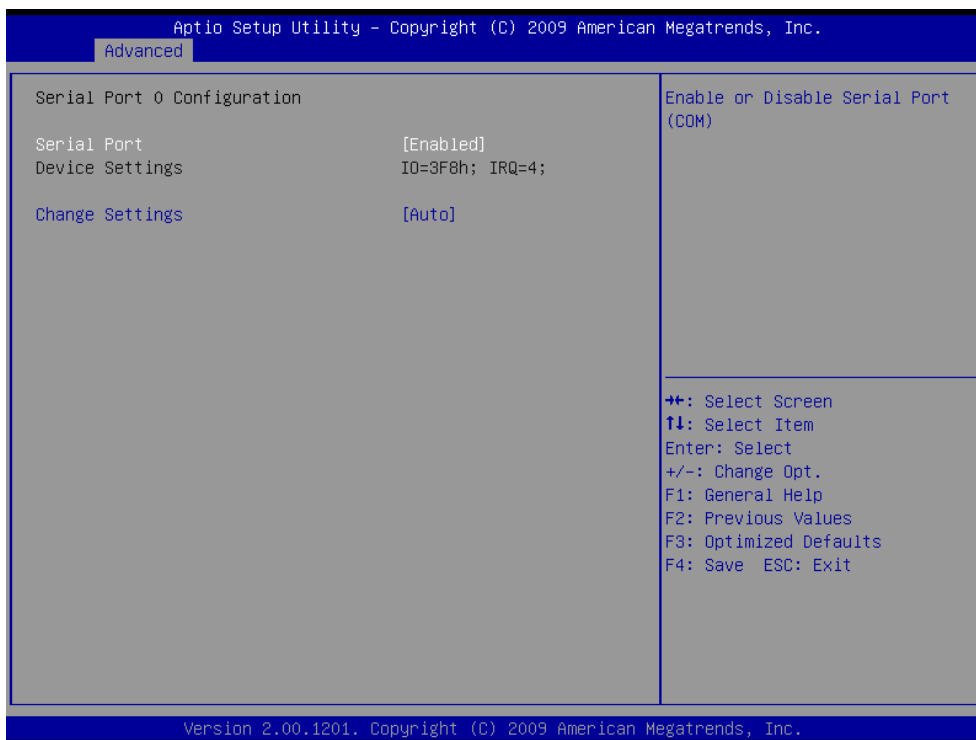

Item	Option	Description
Serial Port	Enabled, Disabled	Use the Serial port option to enable or disable the serial port.
Change Settings	IO=3F8h; IRQ=4, IO=3F8h; IRQ=3,4,5,6,7,10,11,12 IO=2F8h; IRQ=3,4,5,6,7,10,11,12 IO=3E8h; IRQ=3,4,5,6,7,10,11,12 IO=2E8h; IRQ=3,4,5,6,7,10,11,12	Use the change Settings option to change the serial port IO port address and interrupt address.

EPI-QM57

3.5.2.12.2 Serial Port 1 Configuration

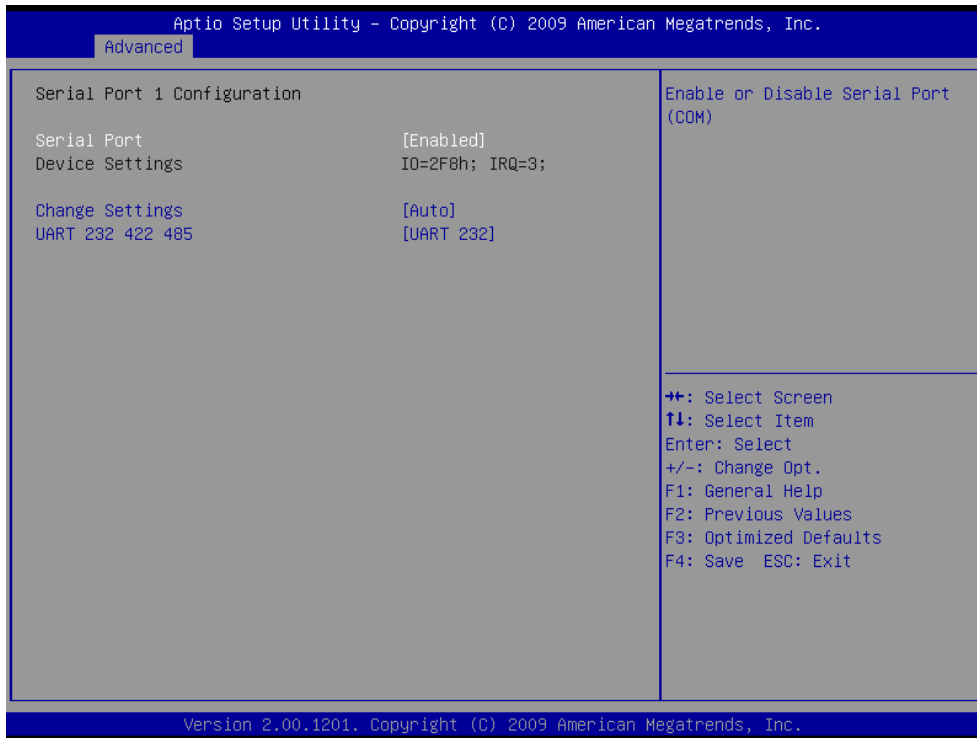

Item	Option	Description
Serial Port	Enabled, Disabled	Use the Serial port option to enable or disable the serial port.
Change Settings	IO=3F8h; IRQ=4, IO=3F8h; IRQ=3,4,5,6,7,10,11,12 IO=2F8h; IRQ=3,4,5,6,7,10,11,12 IO=3E8h; IRQ=3,4,5,6,7,10,11,12 IO=2E8h; IRQ=3,4,5,6,7,10,11,12	Use the change Settings option to change the serial port IO port address and interrupt address.
UART 232 422 485	UART 232, UART 422, UART485	Change the Serial Port as RS232/422/ 485

3.5.2.12 Intelligent Power Sharing

Intelligent Power Sharing configuration menu. (NOTE: DTS must be enabled for Power Sharing to function.)

The choices: Enabled, Disabled.



EPI-QM57

3.5.2.13 AMT Configuration

This item allows the advanced power management options to be configured.

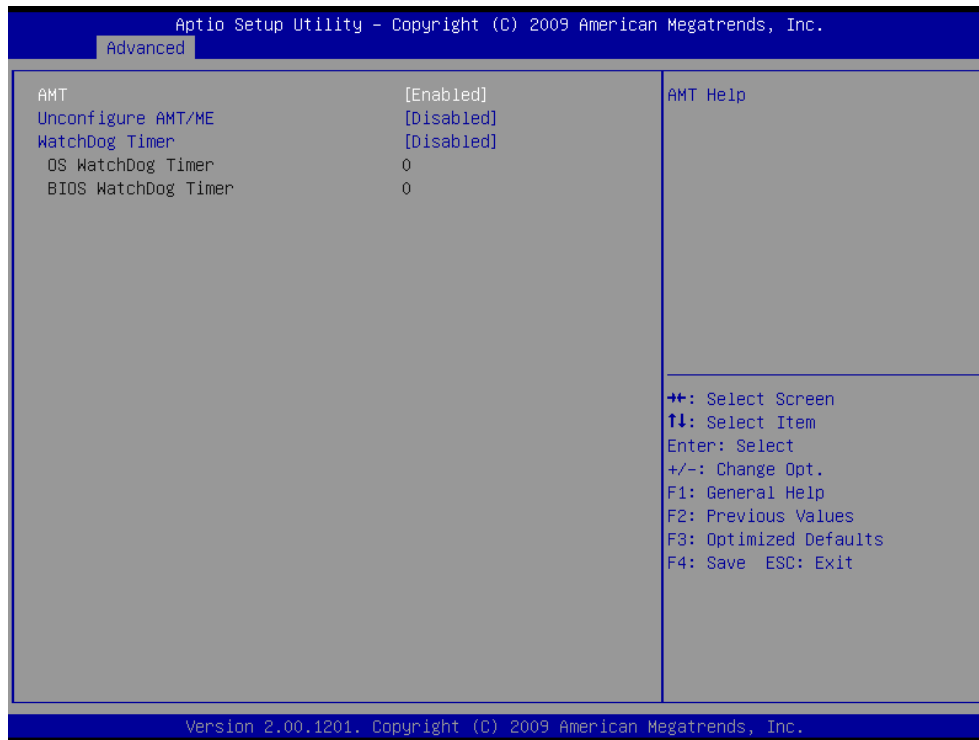

Item	Option	Description
AMT	Enabled, Disabled	Use AMT option to enable/disable the Intel® AMT function.
Unconfigure AMT/ME	Enabled, Disabled	You can use this item to perform AMT/ME unconfigure without password operation.
WatchDog Timer	Enabled, Disabled	This option will determine watch dog timer.

3.5.3 Advanced Chipset Features

This setting configures the north bridge, south bridge and ME subsystem.

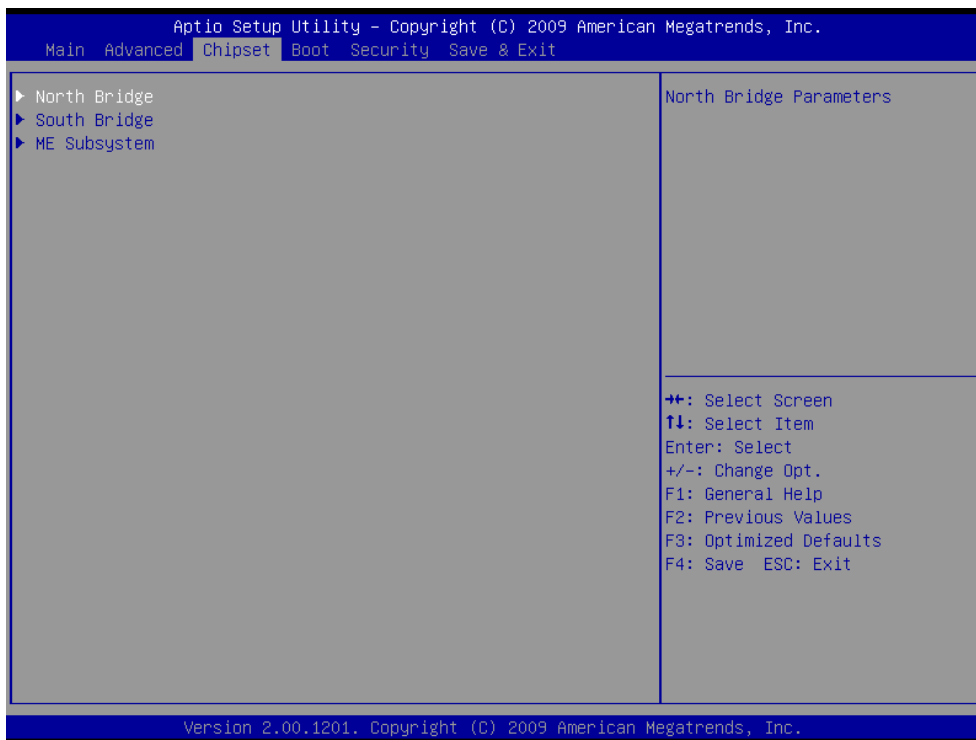

EPI-QM57

3.5.3.1 North Bridge

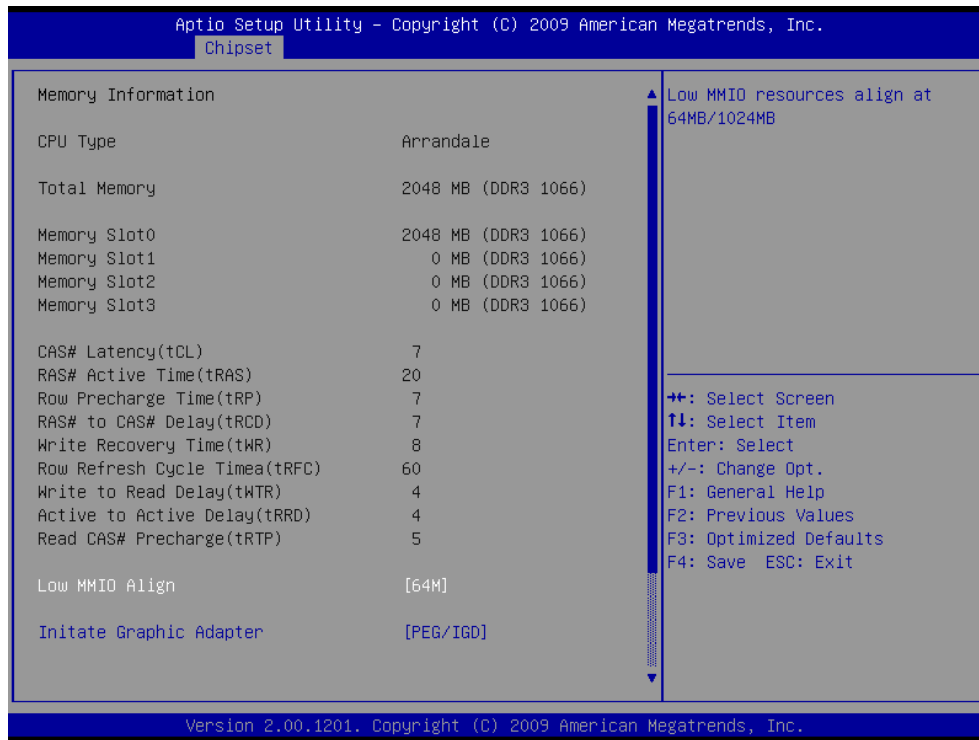

Item	Option	Description
Low MMIO Align	64M, 1024M	This option will determine Low MMIO resources align.
Initiate Graphic Adapter	IGD, PCI/IGD, PCI/PEG, PEG/IGD, PEG/PCI	This item allows you to select which graphics controller to use as the primary boot device.

3.5.3.2 South Bridge

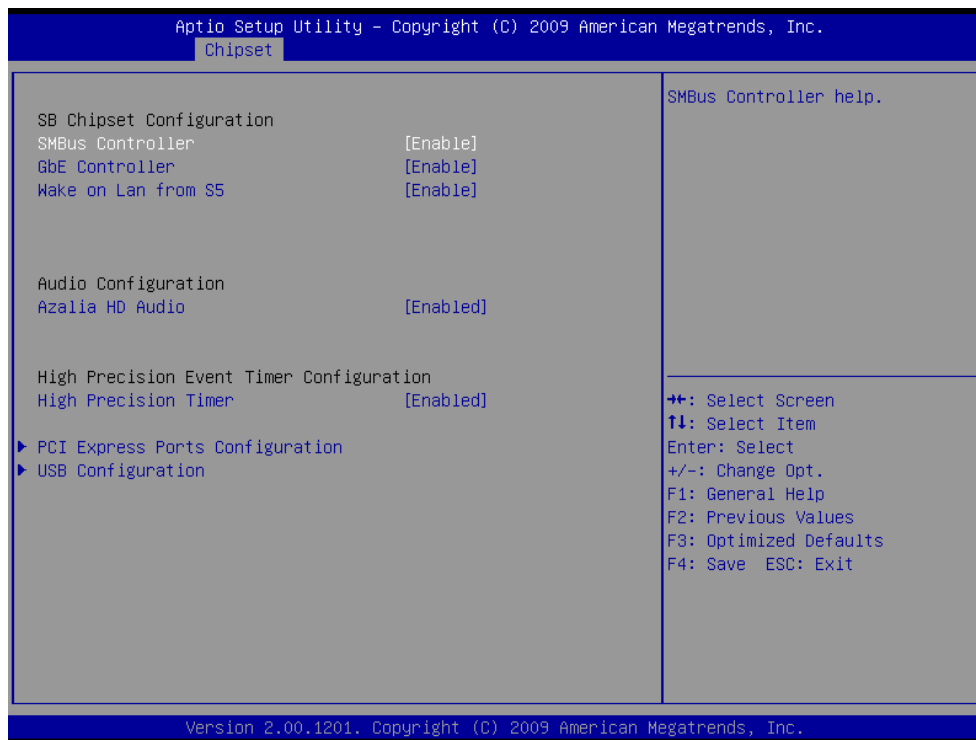

Item	Option	Description
SMBus Controller	Enable, Disable	SMBus Controller help.
GbE Controller	Enable, Disable	GbE Controller help.
Wake on Lan from S5	Enable, Disable	Wake on Lan from S5 help.
Azalia HD Audio	Enable, Disable	Use the Azalia HD Audio option to enable or disable the High Definition Audio controller.
High Precision Timer	Enable, Disable	This item helps to enable or disable high precision timer.

EPI-QM57

3.5.3.2.1 PCI Express Ports Configuration

For the PCI Express root ports, the assignment of a function number to a root port is not fixed. This item allows you to re-assign the function numbers on a port by port basis. You can disable/hide any root port and still have functions 0 thru N-1 where N is the total number of enabled root ports.

The choices: Disable, Enable, Auto.

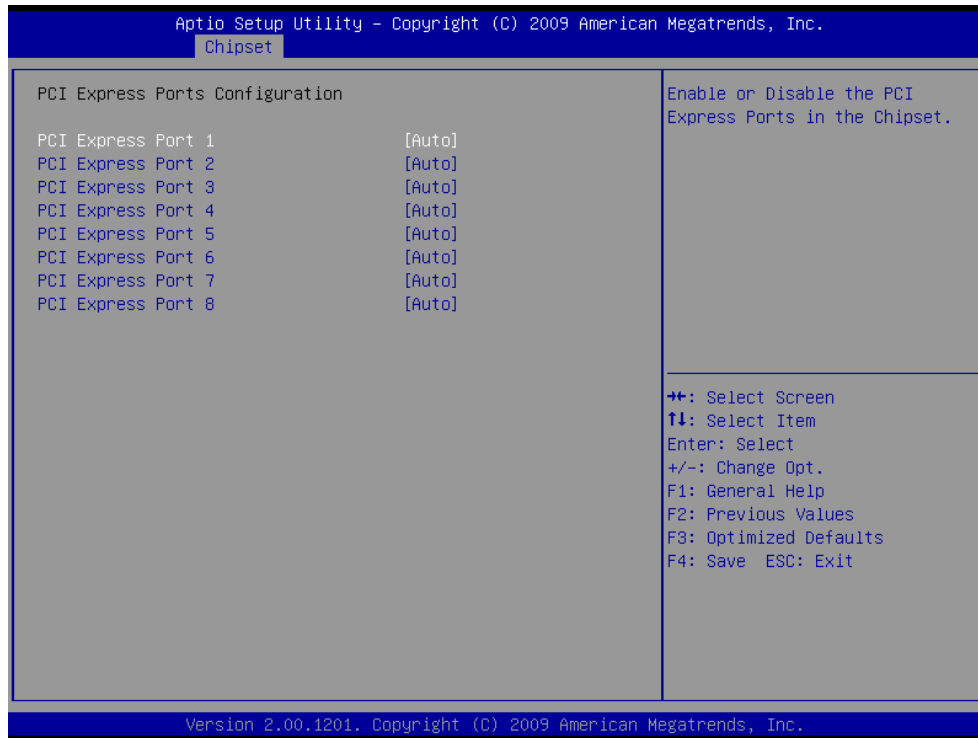

3.5.3.2.2 USB Configuration

The USB Configuration menu is used to read USB configuration information and configure the USB settings.

The choices: Disable, Enable.

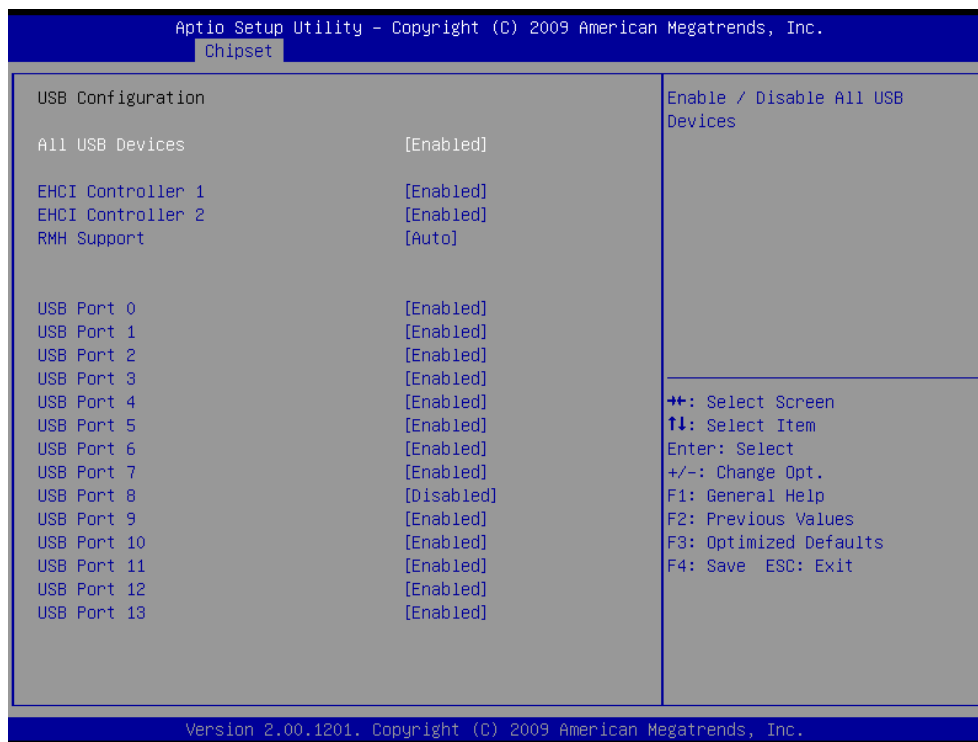

EPI-QM57

3.5.3.3 ME Subsystem

Use the ME Subsystem menu to configure the Intel® Management Engine (ME) configuration options.

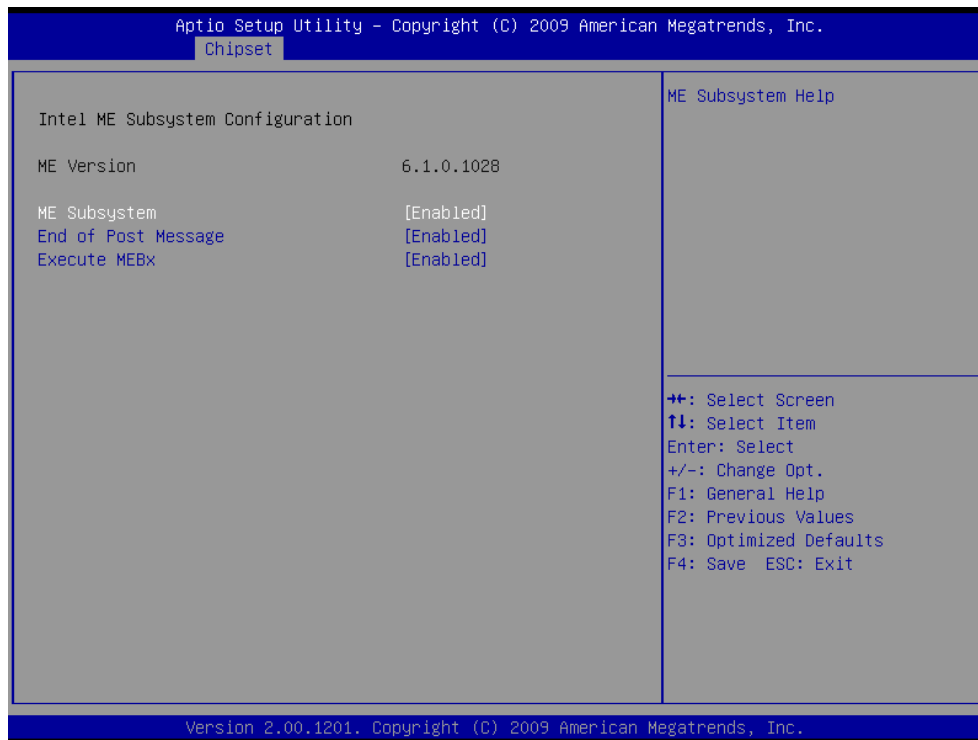

Item	Option	Description
ME Subsystem	Enable, Disable	Use the ME Subsystem option to enable or disable the Intel® ME subsystem.
End of Post Message	Enable, Disable	Use the End of Post Message option to enable or disable the end of post message of the ME Subsystem.
Execute MEBx	Enable, Disable	Use the Execute MEBx option to enable or disable the Intel® Management Engine BIOS extension (MEBx).

3.5.4 Boot

Use Boot menu to set system boot options.

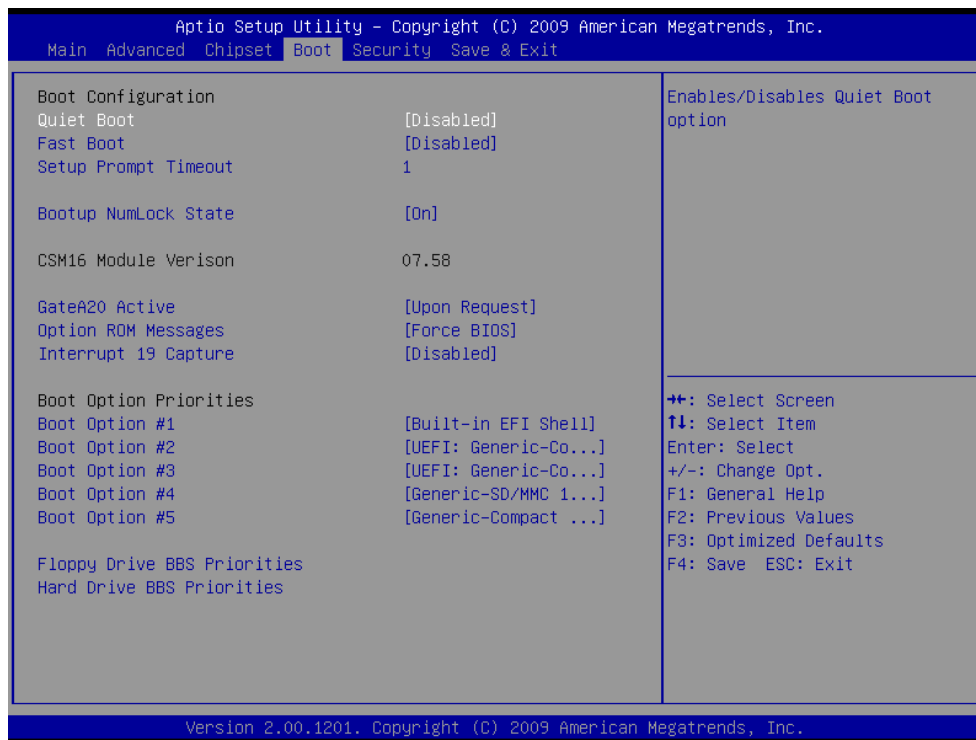

Item	Option	Description
Quiet Boot	Enable, Disable	This item can help to select the screen display when the system boots.
Fast Boot	Enable, Disable	Enable/ Disable boot with initialization of a minimal set of devices required to launch active boot option. Has no effect for BBS boot options.
Setup Prompt Timeout	1	Number of seconds to wait for setup activation key. 65535(0xFFFF) means indefinite waiting.
GateA20 Active	Upon Request, Always	UPON REQUEST – GA20 can be disabled using BIOS services. ALWAYS – do not allow disabling GA20; this option is useful when any RT code is executed above 1MB.
Option ROM Messages	Force BIOS, Keep Current	Set display mode for Option ROM.
Interrupt 19 Capture	Enable, Disable	Enable: Allows Option ROMs to trap int 19.

EPI-QM57

3.5.5 Security

Use the Security menu to set system and user password.



3.5.5.1 Administrator Password

Use the Administrator Password to set or change a administrator password.

3.5.5.2 User Password

Use the User Password to set or change a user password.

3.5.6 Save & Exit

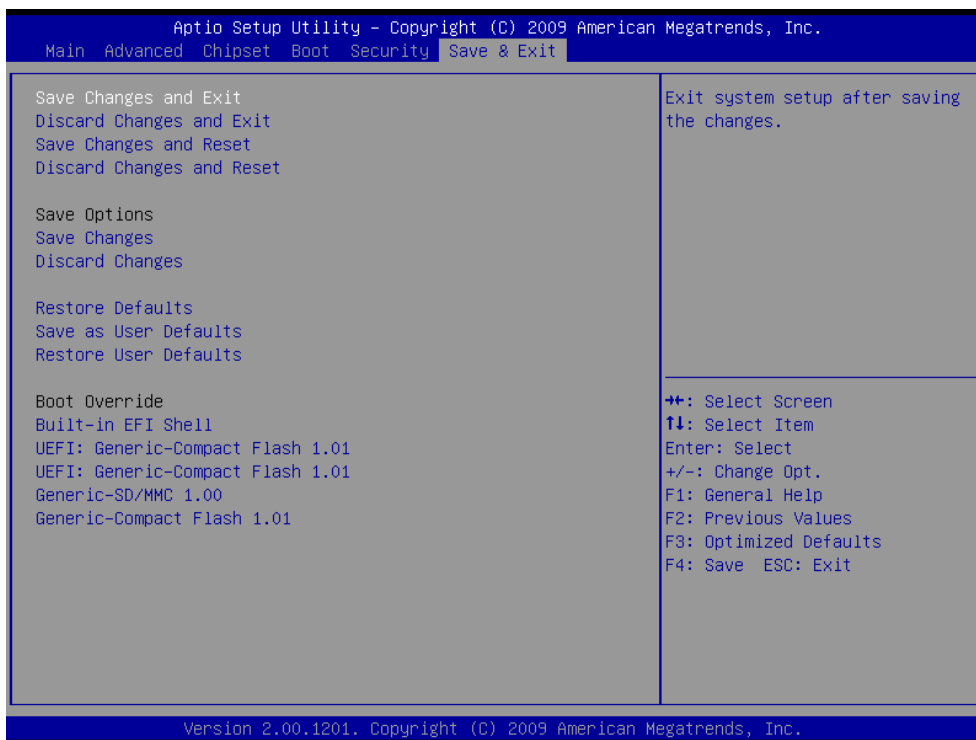

3.5.6.1 Save changes and exit

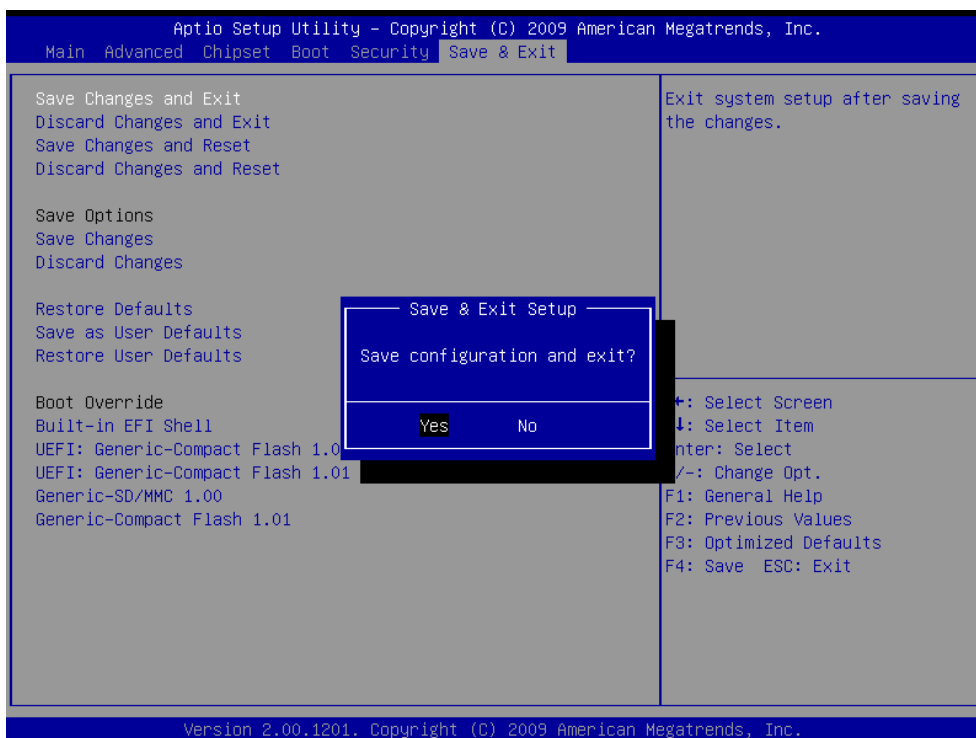

3.5.6.2 Discard Changes and Exit

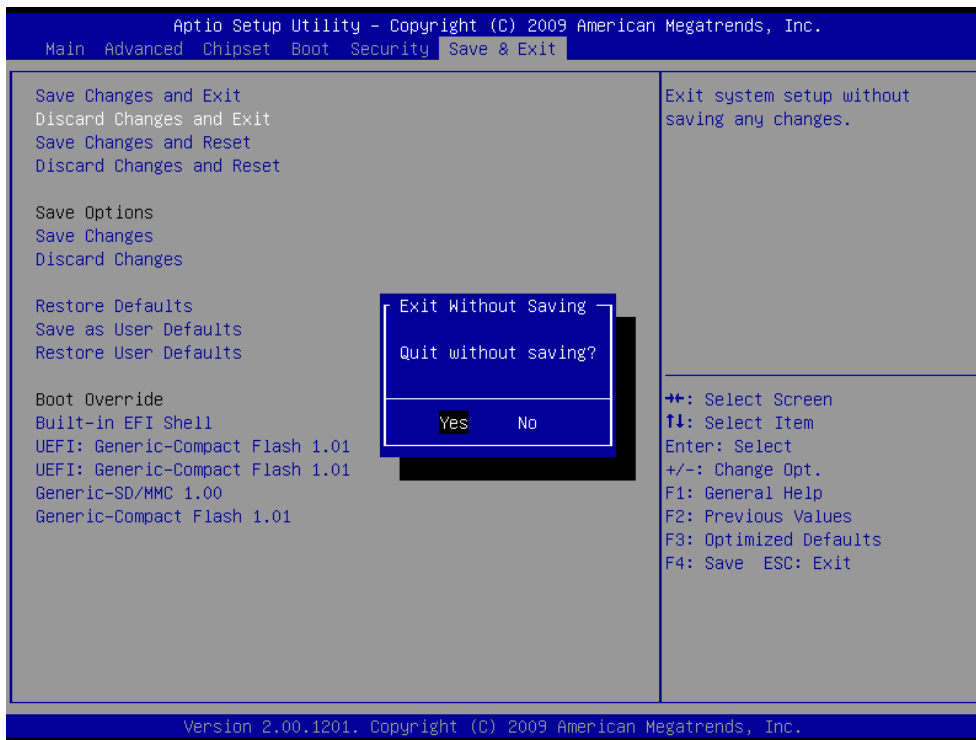

3.5.6.3 Save changes and Reset

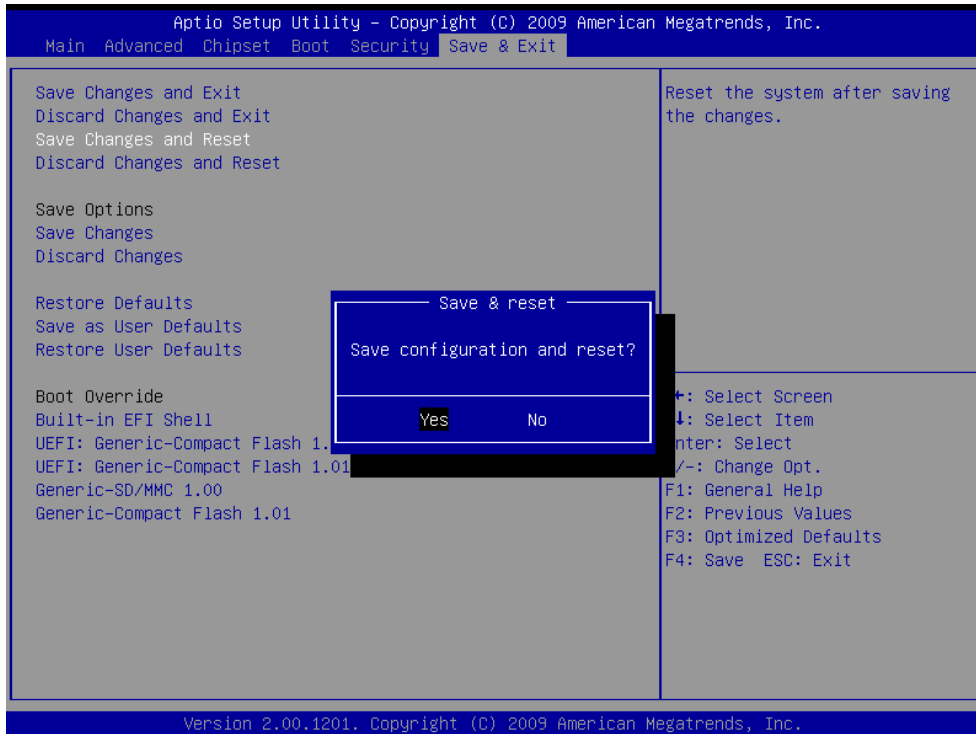

3.5.6.4 Discard Changes and Reset

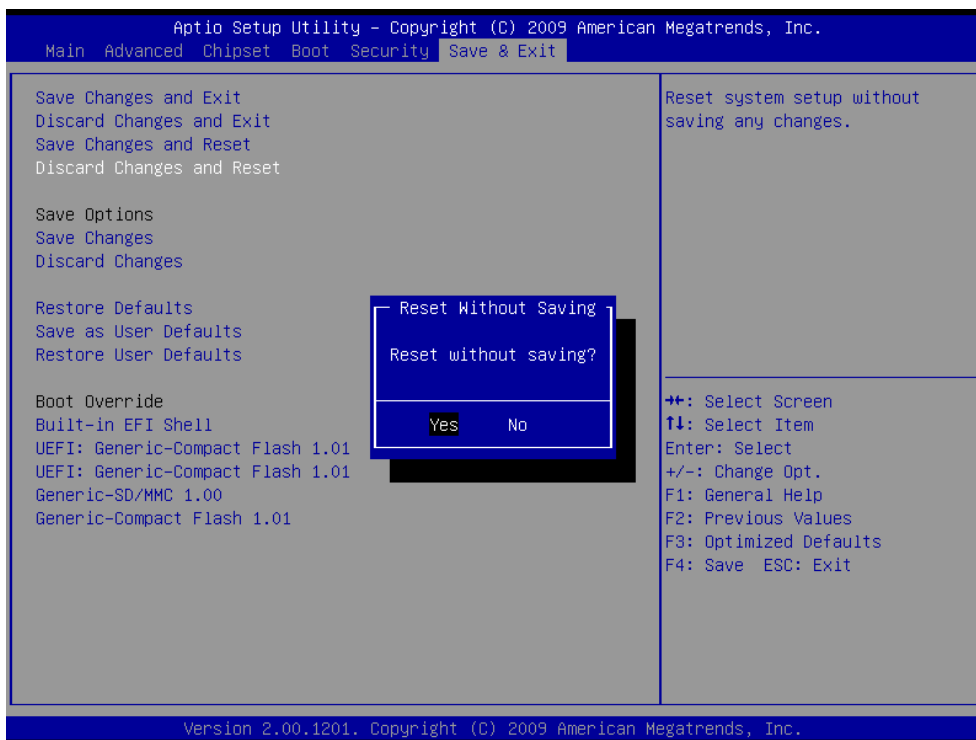

3.5.6.5 Save changes

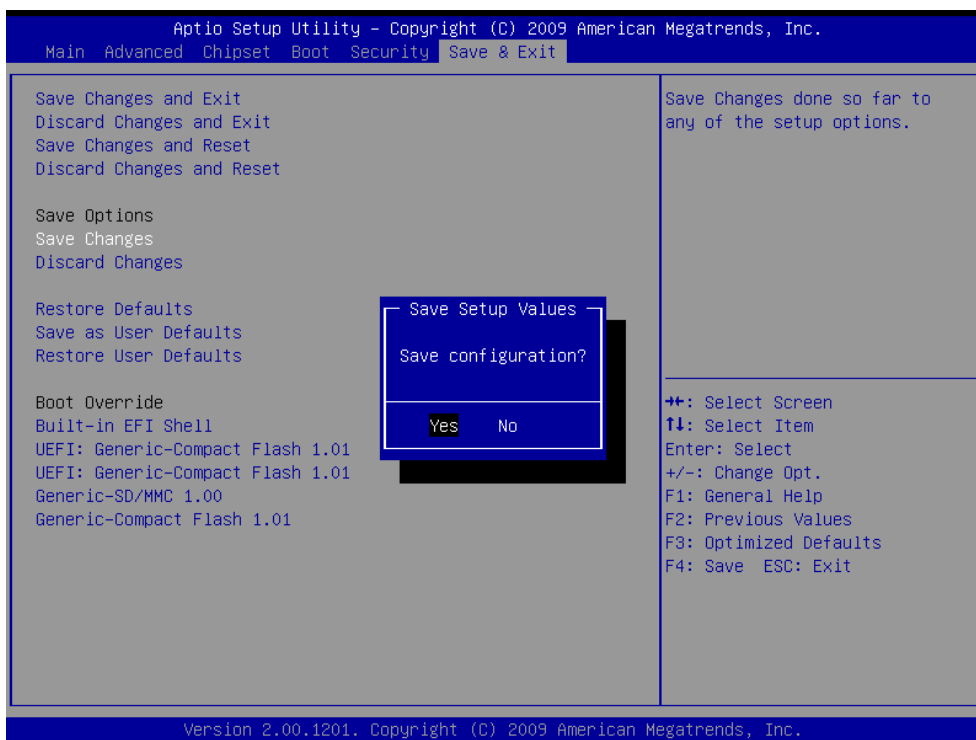

3.5.6.6 Discard Changes



3.5.6.7 Restore Defaults

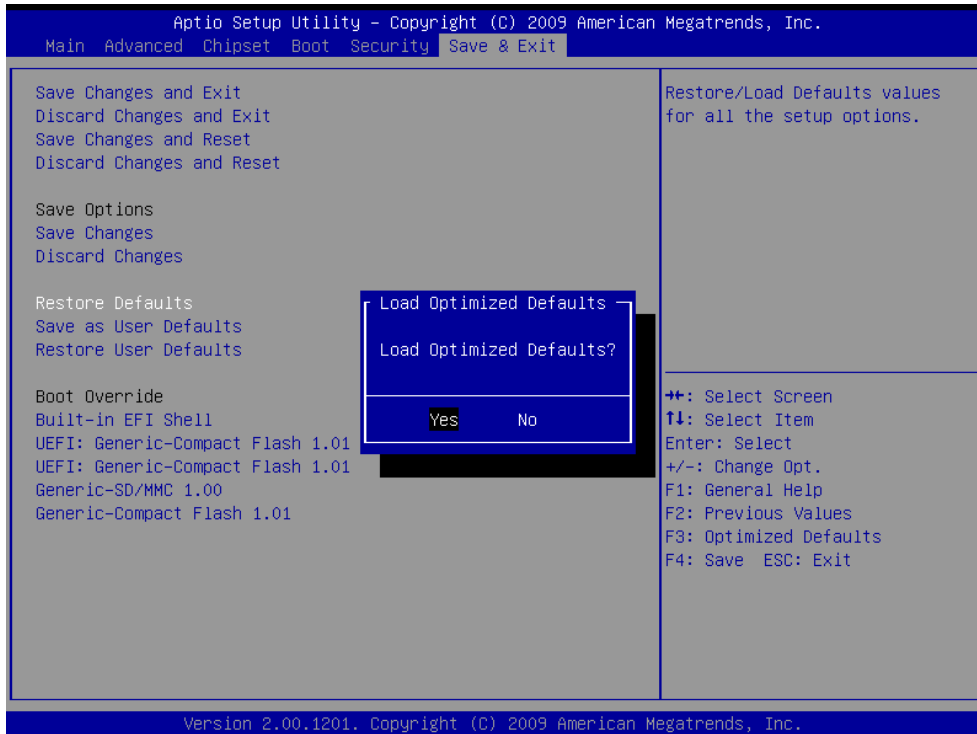

3.5.6.8 Save as User Defaults

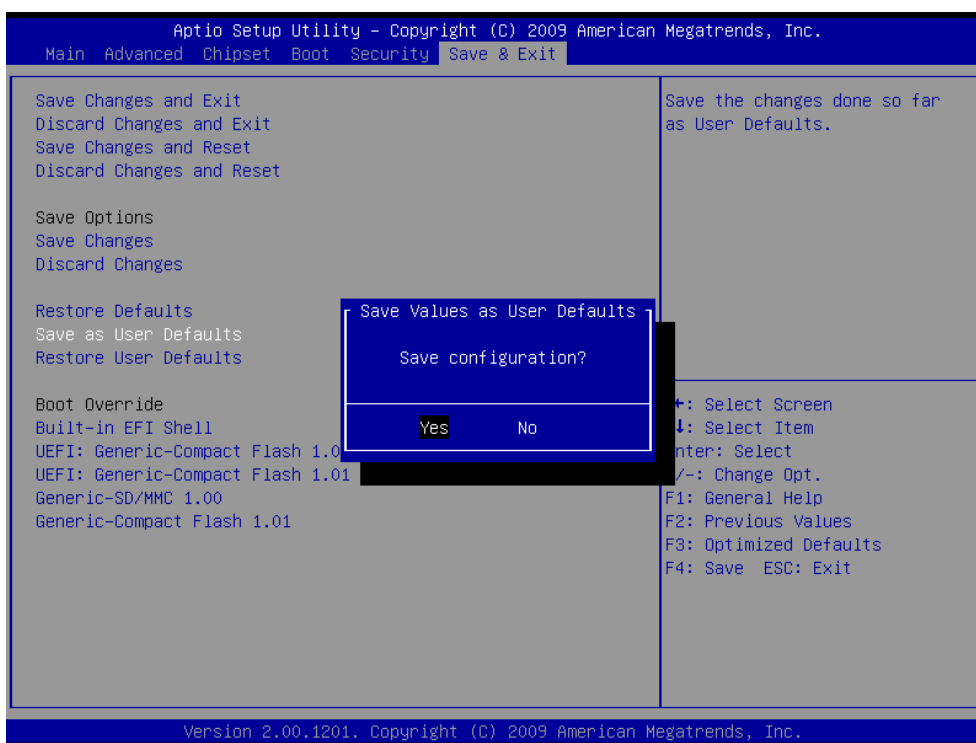

3.5.6.9 Restore User Defaults



4. Drivers Installation



Note: Installation procedures and screen shots in this section are for your reference and may not be exactly the same as shown on your screen.

4.1 Install Chipset Driver (For Intel QM57)

Insert the Supporting DVD-ROM to DVD-ROM drive, and it should show the index page of Avalue's products automatically. If not, locate Index.htm and choose the product from the menu left, or link to \Driver_Chipset\Intel\QM57.



Note: The installation procedures and screen shots in this section are based on Windows XP operation system. If the warning message appears while the installation process, click Continue to go on.

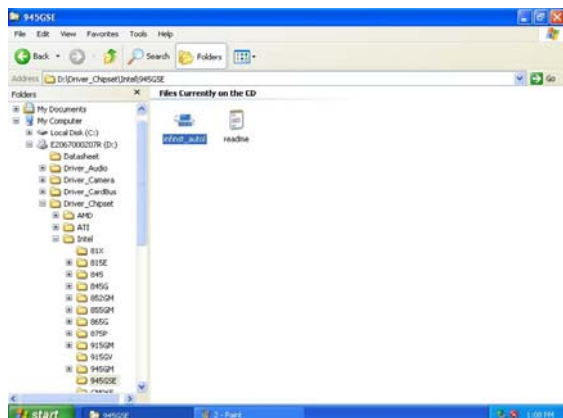

Step1. Locate 「\Driver_Chipset\Intel\QM57\infinst_autol.exe」.



Step 2. Click **Next**.



Step 3. Click **Next**.



Step 4. Click **Finish** to complete setup.

4.2 Install Display Driver (For Intel QM57)

Insert the Supporting DVD-ROM to DVD-ROM drive, and it should show the index page of Avalue's products automatically. If not, locate Index.htm and choose the product from the menu left, or link to \Driver_Video\Intel\QM57.



Note: The installation procedures and screen shots in this section are based on Windows XP operation system.

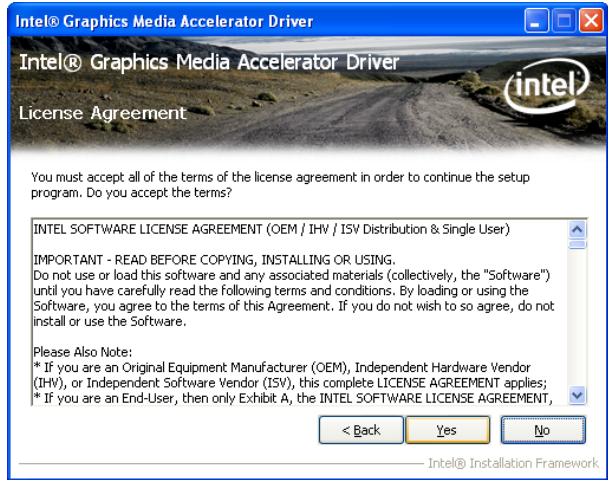

Step 3. Click **Yes**.

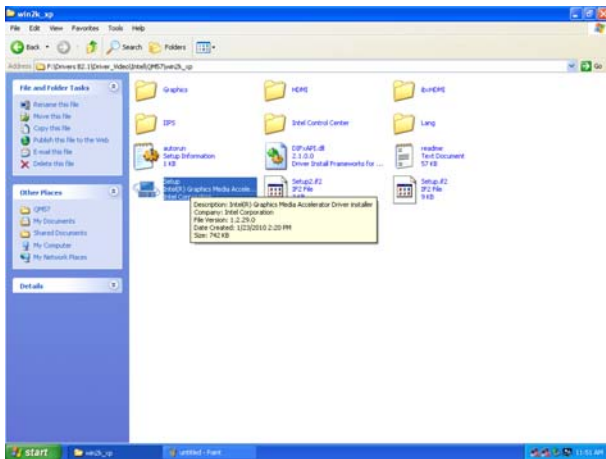

Step 1. Locate 「Driver_Video\Intel\QM57\Setup.exe」.

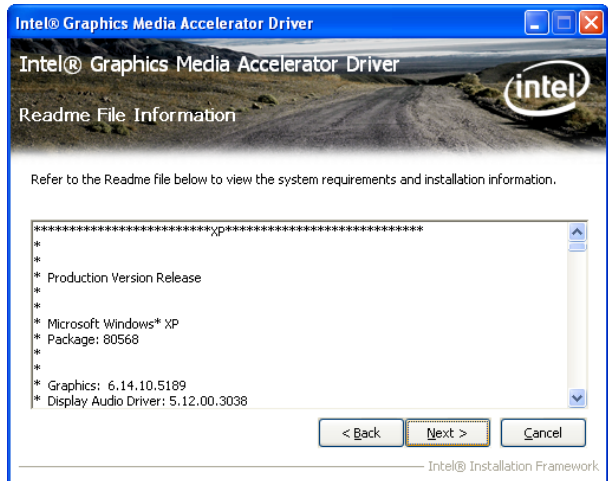

Step 4. Click **Next**.

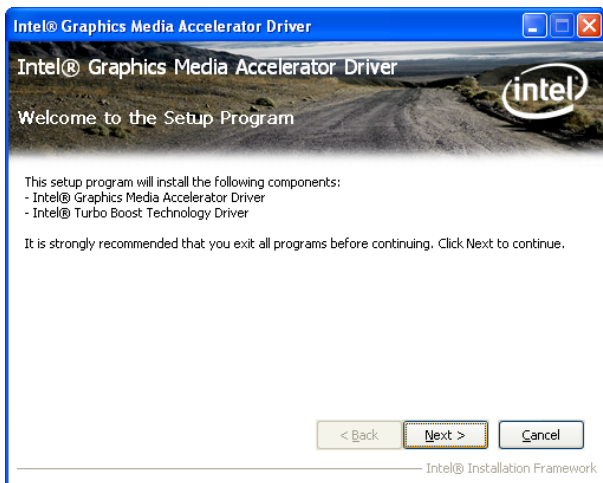

Step 2. Click **Next**.

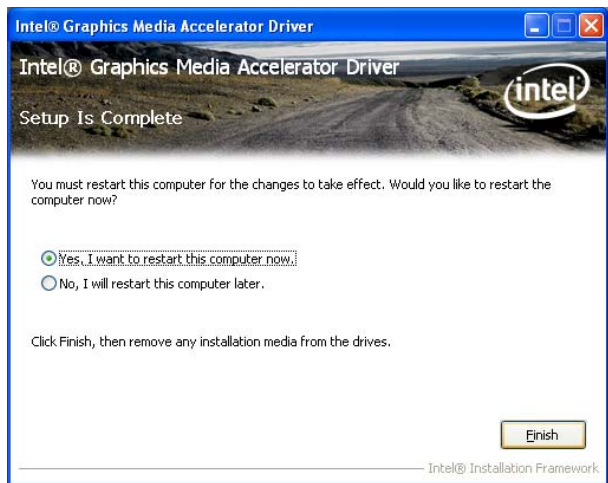

Step 5. Click **Finish** to complete setup.

4.3 Install Audio Driver (For Realtek ALC883)

Insert the Supporting CD-ROM to CD-ROM drive, and it should show the index page of Avalue's products automatically. If not, locate Index.htm and choose the product from the menu left, or link to \Driver_Audio\Realtek \ALC883.



Note: The installation procedures and screen shots in this section are based on Windows 2000 operation system.



Step 3. Select **Next** to the next step.

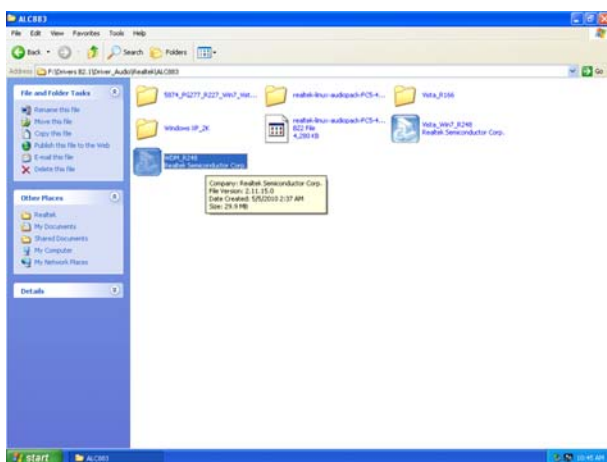

Step 1. Locate 「\Driver_Audio\Intel\6300ESB ALC883\setup.exe」.



Step 4. Click **Finish** to complete the setup.

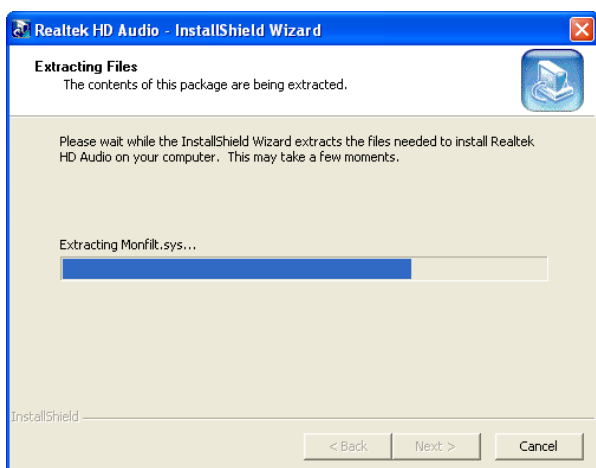

Step 2. The program executes the Setup automatically.

4.4 Install Ethernet Driver (For Intel 82574L/ 82577LM)

Insert the Supporting DVD-ROM to DVD-ROM drive, and it should show the index page of Avalue's products automatically. If not, locate Index.htm and choose the product from the menu left, or link to **D:\Driver_Gigabit\Intel\ 82574L or 82577LM**.



Note: The installation procedures and screen shots in this section are based on Windows XP operation system.

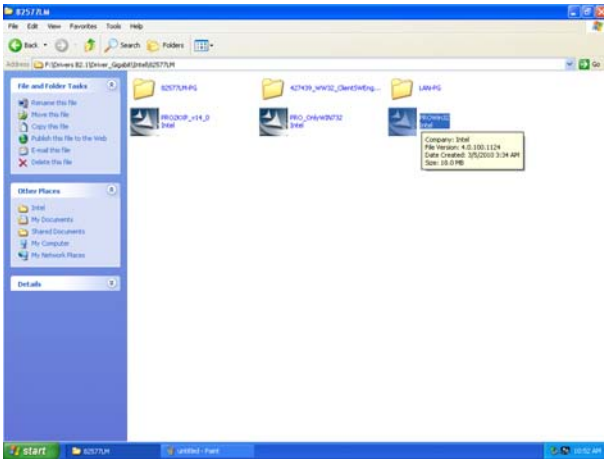

Step 1. Locate 「 \Driver_Gigabit\Intel\ 82574L or 82577LM 」 and choose your system OS.

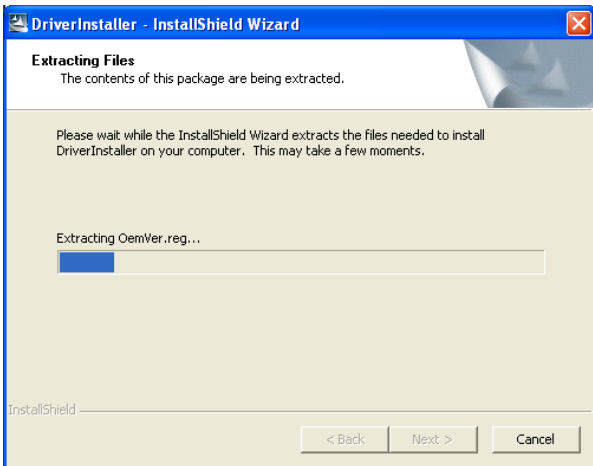

Step 2. Click **Next**.

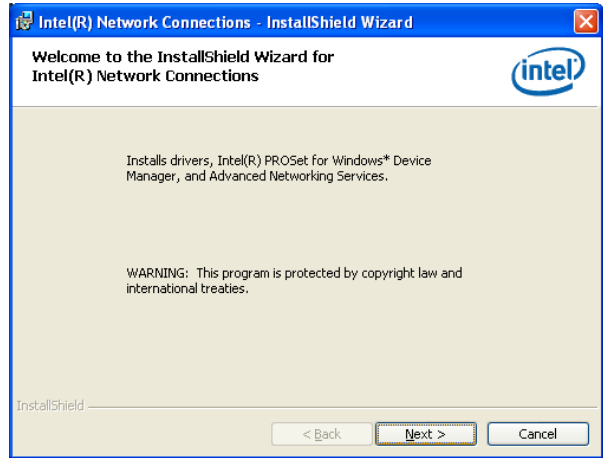

Step 3. Click **Next** to run the installation.

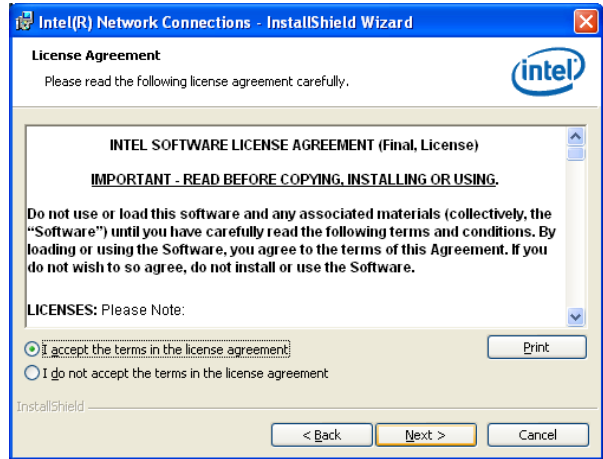

Step 4. Click **Accept** to continue.

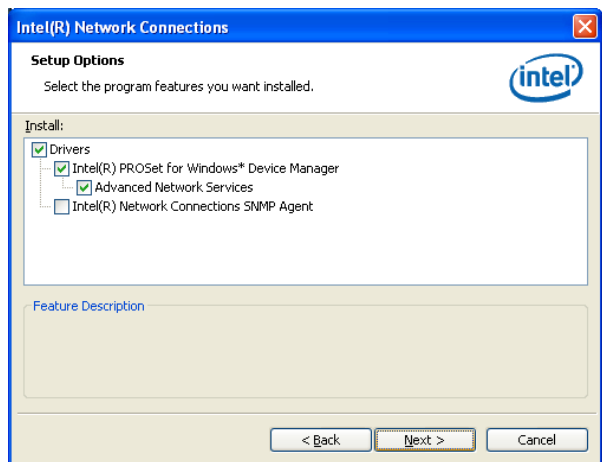

Step 5. Click **Next**.

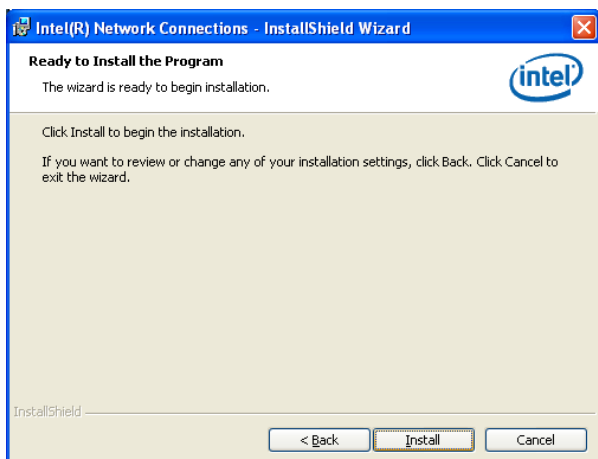

Step 5. Click **Install** to next step.

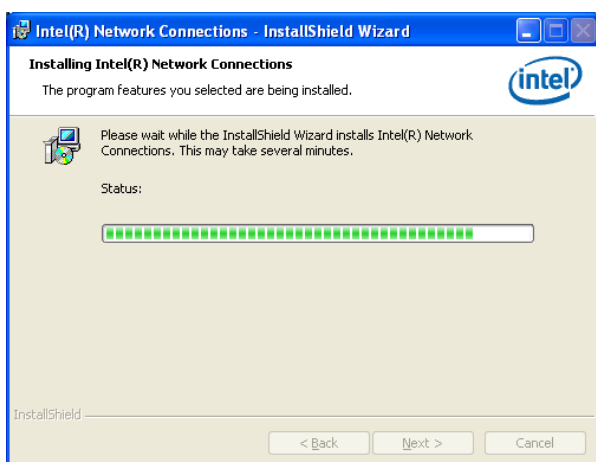

Step 6. Click **Next** to next step.

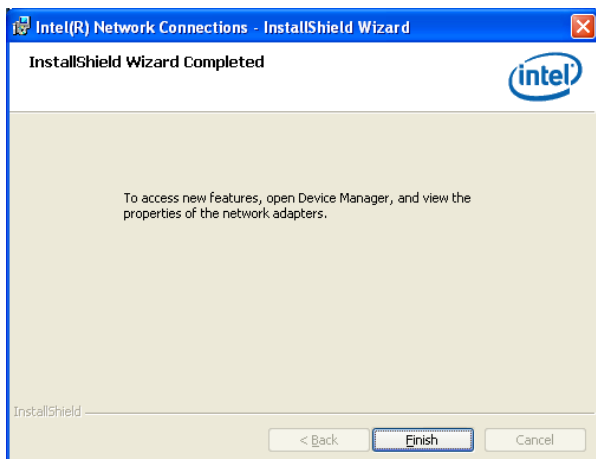

Step 7. Click **Finish** to complete the setup.

5. Mechanical Drawing



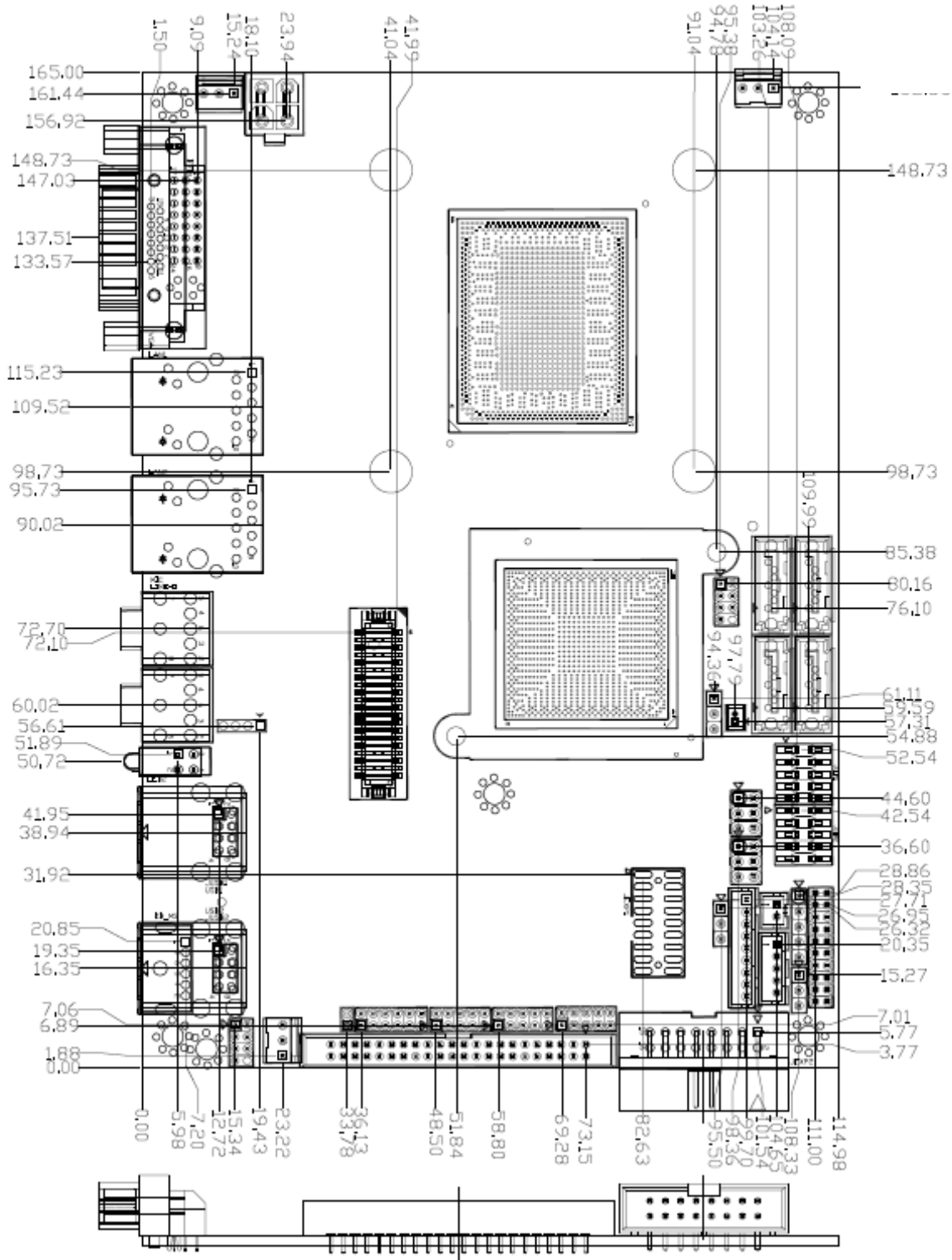

Unit: mm

EPI-QM57

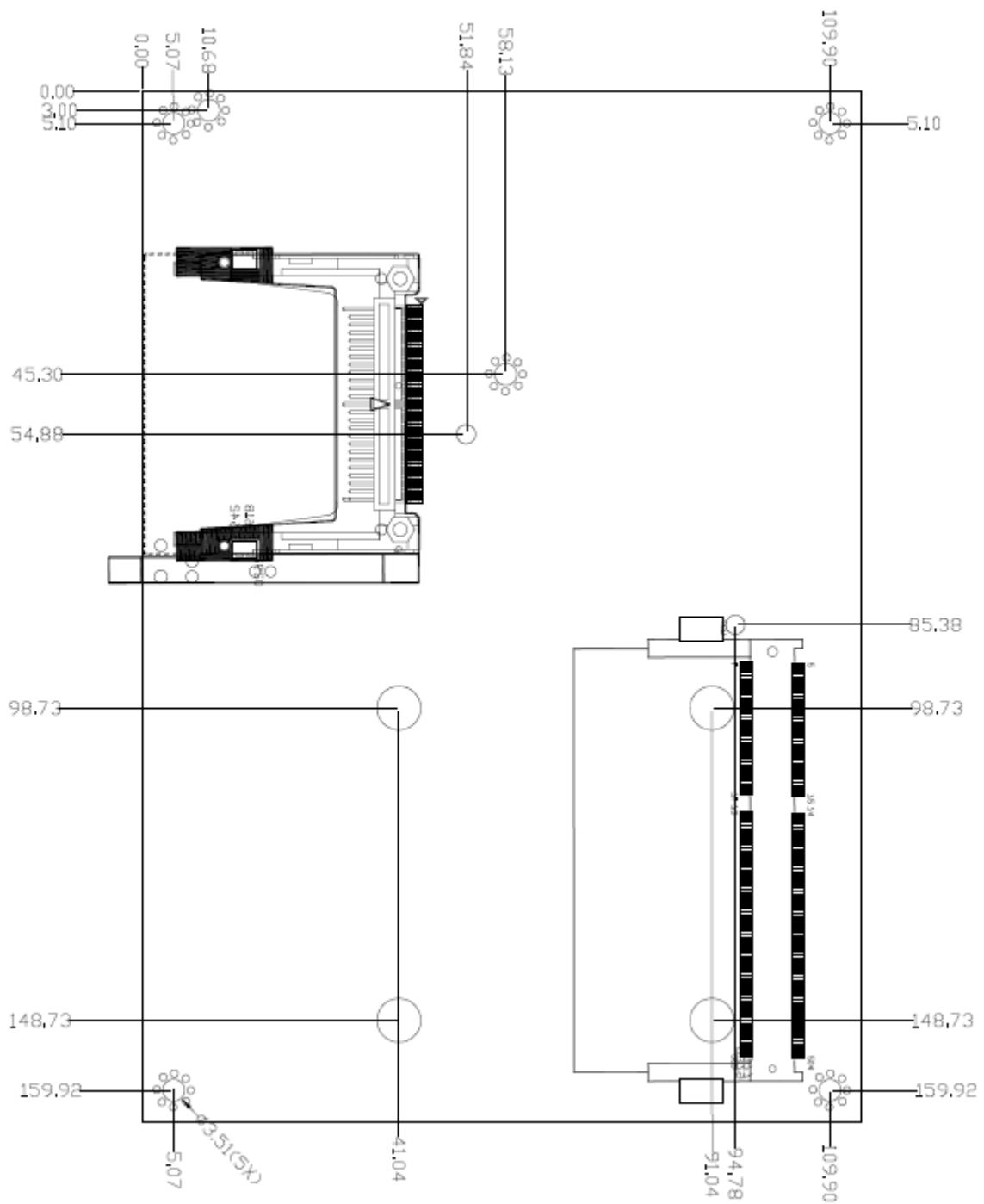

Unit: mm