

EMX-PNV

Intel® Atom™ PNV-D525 Mini ITX Motherboard with Intel®
ICH8-M Chipset

User's Manual



1st Ed -04 August , 2011

FCC Statement



THIS DEVICE COMPLIES WITH PART 15 FCC RULES. OPERATION IS SUBJECT TO THE FOLLOWING TWO CONDITIONS:

(1) THIS DEVICE MAY NOT CAUSE HARMFUL INTERFERENCE.

(2) THIS DEVICE MUST ACCEPT ANY INTERFERENCE RECEIVED INCLUDING INTERFERENCE THAT MAY CAUSE UNDESIRE OPERATION.

THIS EQUIPMENT HAS BEEN TESTED AND FOUND TO COMPLY WITH THE LIMITS FOR A CLASS "A" DIGITAL DEVICE, PURSUANT TO PART 15 OF THE FCC RULES.

THESE LIMITS ARE DESIGNED TO PROVIDE REASONABLE PROTECTION AGAINST HARMFUL INTERFERENCE WHEN THE EQUIPMENT IS OPERATED IN A COMMERCIAL ENVIRONMENT. THIS EQUIPMENT GENERATES, USES, AND CAN RADIATE RADIO FREQUENCY ENERGY AND, IF NOT INSTALLED AND USED IN ACCORDANCE WITH THE INSTRUCTION MANUAL, MAY CAUSE HARMFUL INTERFERENCE TO RADIO COMMUNICATIONS.

OPERATION OF THIS EQUIPMENT IN A RESIDENTIAL AREA IS LIKELY TO CAUSE HARMFUL INTERFERENCE IN WHICH CASE THE USER WILL BE REQUIRED TO CORRECT THE INTERFERENCE AT HIS OWN EXPENSE.

Notice

This guide is designed for experienced users to setup the system within the shortest time. For detailed information, please always refer to the electronic user's manual.

Copyright Notice

Copyright © 2011 Avalue Technology Inc., ALL RIGHTS RESERVED.

No part of this document may be reproduced, copied, translated, or transmitted in any form or by any means, electronic or mechanical, for any purpose, without the prior written permission of the original manufacturer.

Trademark Acknowledgement

Brand and product names are trademarks or registered trademarks of their respective owners.

Disclaimer

Avalue Technology Inc. reserves the right to make changes, without notice, to any product, including circuits and/or software described or contained in this manual in order to improve design and/or performance. Avalue Technology assumes no responsibility or liability for the use of the described product(s), conveys no license or title under any patent, copyright, or masks work rights to these products, and makes no representations or warranties that these products are free from patent, copyright, or mask work right infringement, unless

otherwise specified. Applications that are described in this manual are for illustration purposes only. Avalue Technology Inc. makes no representation or warranty that such application will be suitable for the specified use without further testing or modification.

Life Support Policy

Avalue Technology's PRODUCTS ARE NOT FOR USE AS CRITICAL COMPONENTS IN LIFE SUPPORT DEVICES OR SYSTEMS WITHOUT THE PRIOR WRITTEN APPROVAL OF Avalue Technology Inc.

As used herein:

1. Life support devices or systems are devices or systems which, (a) are intended for surgical implant into body, or (b) support or sustain life and whose failure to perform, when properly used in accordance with instructions for use provided in the labeling, can be reasonably expected to result in significant injury to the user.
2. A critical component is any component of a life support device or system whose failure to perform can be reasonably expected to cause the failure of the life support device or system, or to affect its safety or effectiveness.

A Message to the Customer

Avalue Customer Services

Each and every Avalue's product is built to the most exacting specifications to ensure reliable performance in the harsh and demanding conditions typical of industrial environments. Whether your new Avalue device is destined for the laboratory or the factory floor, you can be assured that your product will provide the reliability and ease of operation for which the name Avalue has come to be known.

Your satisfaction is our primary concern. Here is a guide to Avalue's customer services. To ensure you get the full benefit of our services, please follow the instructions below carefully.

Technical Support

We want you to get the maximum performance from your products. So if you run into technical difficulties, we are here to help. For the most frequently asked questions, you can easily find answers in your product documentation. These answers are normally a lot more detailed than the ones we can give over the phone. So please consult the user's manual first.

To receive the latest version of the user's manual; please visit our Web site at:

<http://www.avalue.com.tw/>

EMX-PNV

If you still cannot find the answer, gather all the information or questions that apply to your problem, and with the product close at hand, call your dealer. Our dealers are well trained and ready to give you the support you need to get the most from your Avalue's products. In fact, most problems reported are minor and are able to be easily solved over the phone. In addition, free technical support is available from Avalue's engineers every business day. We are always ready to give advice on application requirements or specific information on the installation and operation of any of our products. Please do not hesitate to call or e-mail us.

Headquarters and Branch

Avalue Technology Inc.

7F, 228, Lian-cheng Road, Chung Ho City, Taipei,
Taiwan

Tel: +886-2-8226-2345

Fax: +886-2-8226-2777

Information: sales@avalue.com.tw

Service: service@avalue.com.tw

Avalue USA

Avalue Technology Inc.

9 Timber Lane, Marlboro, NJ 07746-1443

Tel: (732) 414-6500

Fax: (732) 414-6501

Information: sales@avalue-usa.com

Service: support@avalue-usa.com

BCM Advanced Research

BCM Advanced Research an Avalue Company

7 Marconi, Irvine, CA92618

Tel: +1-949-470-1888

Fax: +1-949-470-0971

Information: BCMSales@bcmcom.com

Web: www.bcmcom.com

Avalue Europe

Avalue Europe A/S

Moelledalen 22C, 3140

Aalsgaarde, Denmark

Tel: +45-7025-0310

Fax: +45-4975-5026

Information: sales.europe@avalue.com.tw

Service: service.europe@avalue.com.tw

Avalue China

Avalue Technology Inc.

Room 805, Building 9, No.99 Tianzhou Rd.,
Caohejing Development Area,
Xuhui District, Shanghai

Tel: +86-21-5169-3609

Fax: +86-21-5445-3266

Information: sales.china@avalue.com.cn

Service: service@avalue.com.tw

Avalue Japan

Avalue Technology Inc.

2F keduka-Bldg, 2-27-3 Taito,

Taito-Ku, Tokyo 110-0016 Japan

Tel: +81-3-5807-2321

Fax: +81-3-5807-2322

Information: sales.japan@avalue.com.tw

Service: service@avalue.com.tw

Product Warranty

Avalue warrants to you, the original purchaser, that each of its products will be free from defects in materials and workmanship for two years from the date of purchase.

This warranty does not apply to any products which have been repaired or altered by persons other than repair personnel authorized by Avalue, or which have been subject to misuse, abuse, accident or improper installation. Avalue assumes no liability under the terms of this warranty as a consequence of such events. Because of Avalue's high quality-control standards and rigorous testing, most of our customers never need to use our repair service. If any of Avalue's products is defective, it will be repaired or replaced at no charge during the warranty period. For out-of-warranty repairs, you will be billed according to the cost of replacement materials, service time, and freight. Please consult your dealer for more details. If you think you have a defective product, follow these steps:

1. Collect all the information about the problem encountered. (For example, CPU type and speed, Avalue's products model name, hardware & BIOS revision number, other hardware and software used, etc.) Note anything abnormal and list any on-screen messages you get when the problem occurs.
2. Call your dealer and describe the problem. Please have your manual, product, and any helpful information available.
3. If your product is diagnosed as defective, obtain an RMA (return material authorization) number from your dealer. This allows us to process your good return more quickly.
4. Carefully pack the defective product, a complete Repair and Replacement Order Card and a photocopy proof of purchase date (such as your sales receipt) in a shippable container. A product returned without proof of the purchase date is not eligible for warranty service.
5. Write the RMA number visibly on the outside of the package and ship it prepaid to your dealer.

Contents

1. Getting Started	8
1.1 Safety Precautions	8
1.2 Packing List.....	8
1.3 Document Amendment History	9
1.4 Manual Objectives.....	10
1.5 System Specifications	11
1.6 Architecture Overview – Block Diagram.....	13
2. Hardware Configuration	14
2.1 Product Overview.....	15
2.2 Installation Procedure	16
2.2.1 Main Memory.....	17
2.3 Jumper and Connector List.....	19
2.4 Setting Jumpers & Connectors	21
2.4.1 Clear CMOS (JBAT1).....	21
2.4.2 Miscellaneous setting connector (JFTP1).....	21
2.4.3 Serial port 3/ 4/ 2/ 1 pin 9 signal select (JP1/ JP2/ JP3/ JP4).....	22
2.4.4 Serial Port 2 Connector in RS232/422/485 (JP5)	22
2.4.5 Serial Port 2 Connector in RS232/422/485 (JP6)	23
2.4.6 ATX power connector (PWR1).....	23
2.4.7 Speaker out connector (CN1)	24
2.4.8 USB connector 4 & 5/ 6 & 7 (CN2/ CN3)	24
2.4.9 SPI connector (CN4)	25
2.4.10 Serial port 4/ 3 connector (CN5/ CN7).....	25
2.4.11 LCD backlight brightness adjustment (VR1).....	26
2.4.12 LCD Inverter Connector (CN6)	26
2.4.13 CD-ROM Audio Connector (CN8).....	27
2.4.14 Front audio connector (CN9)	27
2.4.15 General purpose I/O connector (DIO1).....	28
2.4.16 CPU/System fan connector (FAN1/FAN2).....	29
2.4.17 VGA power connector (JVGA1).....	29
2.4.18 VGA connector (JVGA2).....	30
2.4.19 Print port connector (LPT1).....	30
2.4.20 LVDS connector (LVDS1).....	31
3. BIOS Setup	32
3.1 Introduction	33
3.2 Starting Setup	33
3.3 Using Setup	34

3.4	Getting Help	35
3.5	In Case of Problems.....	35
3.6	BIOS setup.....	36
3.6.1	Main Menu and System information.....	36
3.6.2	Advanced Settings	37
3.6.3	PCI Pnp.....	54
3.6.4	Boot settings	55
3.6.5	Security settings	58
3.6.6	Advanced Chipset Settings.....	59
3.6.7	Exit Options	64
4.	Drivers Installation.....	65
4.1	Install Ethernet Driver (For Intel 82583V).....	66
5.	Mechanical Drawing	68

1. Getting Started

1.1 Safety Precautions

Warning!



Always completely disconnect the power cord from your chassis whenever you work with the hardware. Do not make connections while the power is on. Sensitive electronic components can be damaged by sudden power surges. Only experienced electronics personnel should open the PC chassis.

Caution!



Always ground yourself to remove any static charge before touching the CPU card. Modern electronic devices are very sensitive to static electric charges. As a safety precaution, use a grounding wrist strap at all times. Place all electronic components in a static-dissipative surface or static-shielded bag when they are not in the chassis.

1.2 Packing List

Before you begin installing your single board, please make sure that the following materials have been shipped:

- 1 x EMX-PNV Mini ITX Main Board
- 1 x DVD-ROM contains the followings:
 - User's manual in PDF file
 - Driver
- 2 x SATA & power cable



If any of the above items is damaged or missing, contact your retailer.

1.3 Document Amendment History

Revision	Date	Comment
1 st	August 2011	Initial Release

1.4 Manual Objectives

This manual describes in detail the Avalue Technology EMX-PNV Motherboard.





We have tried to include as much information as possible but we have not duplicated information that is provided in the standard IBM Technical References, unless it proved to be necessary to aid in the understanding of this board.

We strongly recommend that you study this manual carefully before attempting to interface with EMX-PNV series or change the standard configurations. Whilst all the necessary information is available in this manual we would recommend that unless you are confident, you contact your supplier for guidance.



Please be aware that it is possible to create configurations within the CMOS RAM that make booting impossible. If this should happen, clear the CMOS settings, (see the description of the Jumper Settings for details).

If you have any suggestions or find any errors concerning this manual and want to inform us of these, please contact our Customer Service department with the relevant details.

1.5 System Specifications

System 	
CPU	Onboard Intel PNV-D DC D525 (EMX-PNV-D525)
BIOS	AMI EFI BIOS (8Mbit SPI)
System Chipset	ICH8M
I/O Chip	Winbond 83627DHG
System Memory	1 x 204-pin SODIMM 4GB DDR3 800MHz SDRAM(EMX-PNV-D525)
SSD	One CompactFlash Type I/II Socket
Watchdog Timer	Reset: 1 sec.~255 min. and 1 sec. or 1 min./step
H/W Status Monitor	Monitoring CPU temperature and cooling fan status. Auto throttling control when CPU overheats
S3/ S4	Yes (S1/S3/S4/S5)
SmartFan Control	Yes
Expansion	1x PCI 1x Mini PCI-E x1
I/O 	
MIO	2 x SATA/ SATA II, 4 x COM (5V/ 12V), 1 x PS/2 KB/MS, 1 x LPT
USB	8 x USB 2.0
D/I/O	16-bit General Purpose I/O for DI and DO
Display 	
Chipset	Integrated Intel® Gen3.5+GFX Render Core 200MHz (Pineview-M)/400MHz (Pineview-D)
Display Memory	Shared Memory
Resolution	VGA mode : up to 2048 x 1536 @ 60 Hz (PNV-D) VGA mode : up to 1400 x 1050 @ 60 Hz (PNV-M)
Dual Display	VGA + LVDS
VGA	One D-sub & one Buffered Pin-head Shared The Same Signals
LVDS	Single channel 18 bit
Audio 	
AC97 Codec	Realtek ALC888 Supports 5.1+2-CH Audio
Audio Interface	Mic-in, Line-out, Line-in
Audio Amplifier	PA3005D2 Stereo 6 Watt Per Channel

EMX-PNV

Ethernet 	
LAN1	Intel® 82583V PCI-E Gigabit LAN
LAN2	Intel® 82583V PCI-E Gigabit LAN
Mechanical & Environmental 	
Power Requirement	ATX/ AT
Operation Temperature	0~60°C (32~140°F)
Operating Humidity	0%~90% relative humidity, non-condensing
Size (L x W)	6.69" x 6.69" (170 mm x 170 mm)
Weight	0.88lbs (0.4Kg)

1.6 Architecture Overview – Block Diagram

The following block diagram shows the architecture and main components of EMX-PNV.

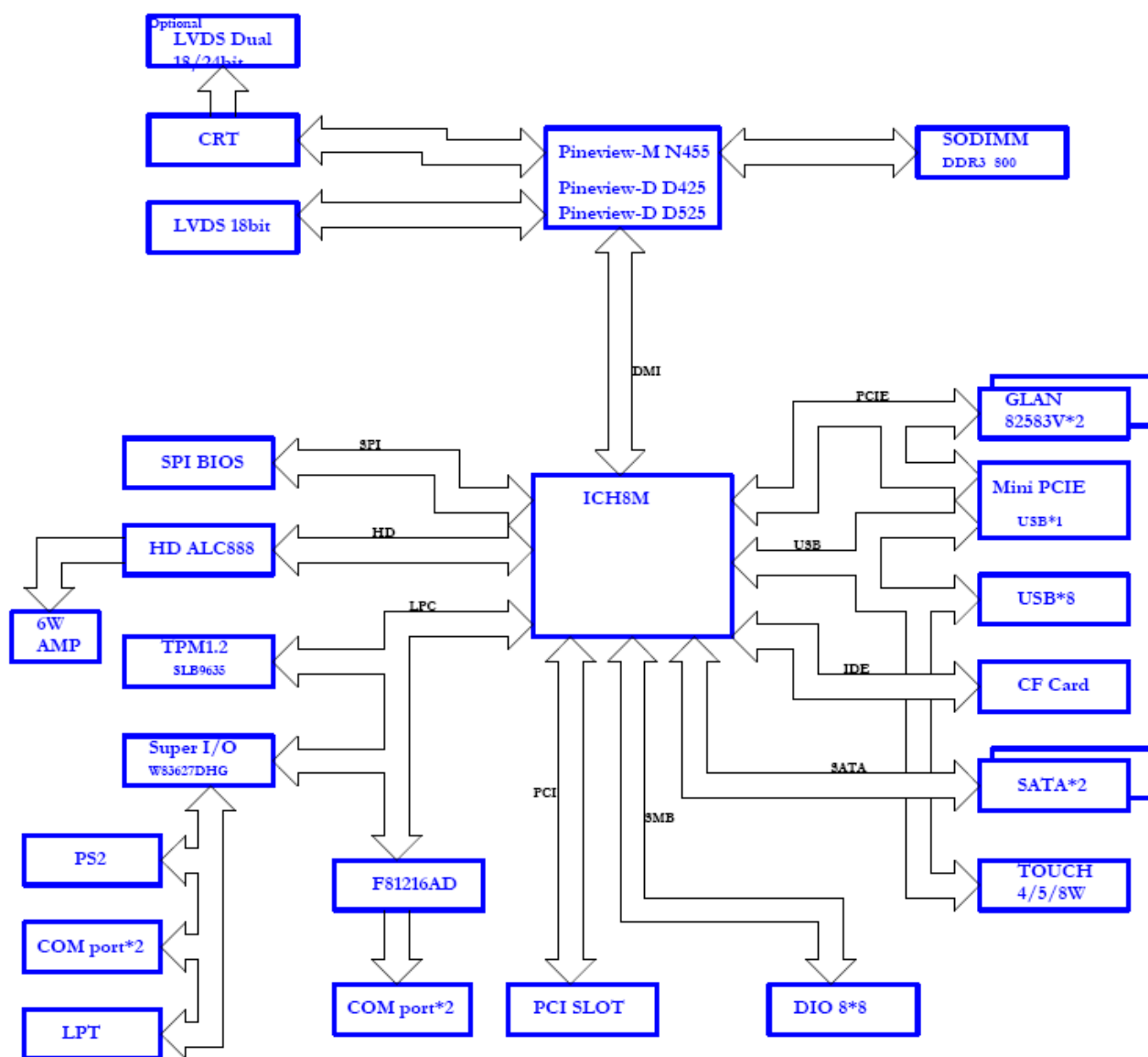

2. Hardware Configuration

2.1 Product Overview

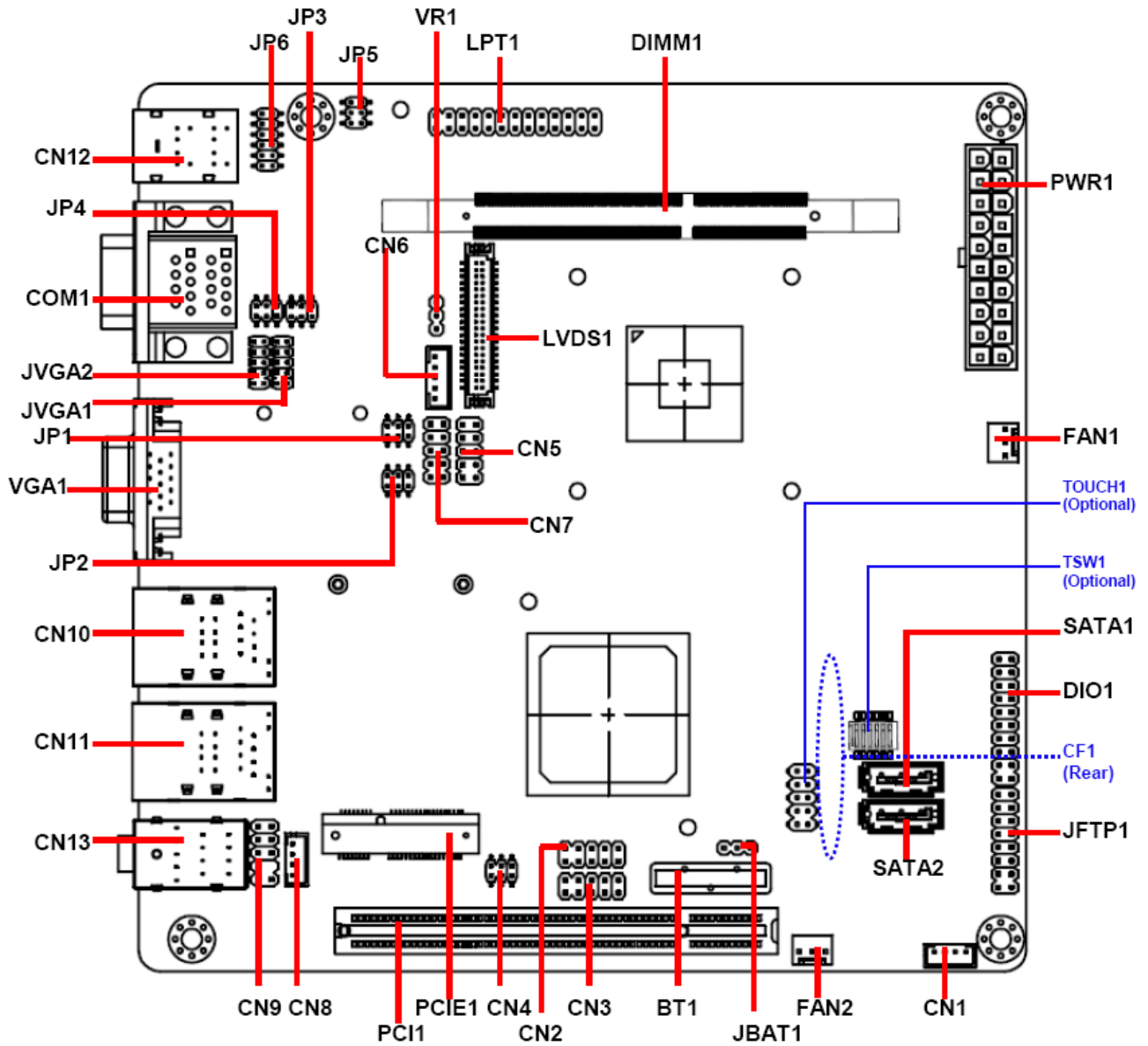

2.2 Installation Procedure

This chapter explains you the instructions of how to setup your system.

1. Turn off the power supply.
2. Insert the SODIMM module (be careful with the orientation).
3. Insert all external cables for hard disk, floppy, keyboard, mouse, USB etc. except for flat panel. A CRT monitor must be connected in order to change CMOS settings to support flat panel.
4. Connect power supply to the board via the ATXPWR.
5. Turn on the power.
6. Enter the BIOS setup by pressing the delete key during boot up. Use the “LOAD BIOS DEFAULTS” feature. The ***Integrated Peripheral Setup*** and the ***Standard CMOS Setup*** Window must be entered and configured correctly to match the particular system configuration.
7. If TFT panel display is to be utilized, make sure the panel voltage is correctly set before connecting the display cable and turning on the power.



Note: Make sure the heat sink and the CPU top surface are in total contact to avoid CPU overheating problem that would cause the system to hang or unstable

2.2.1 Main Memory

EMX-PNV provides 1x 204 SODIMM and supports up to DDR3 800MHz SDRAM. The total maximum memory size is 4GB.

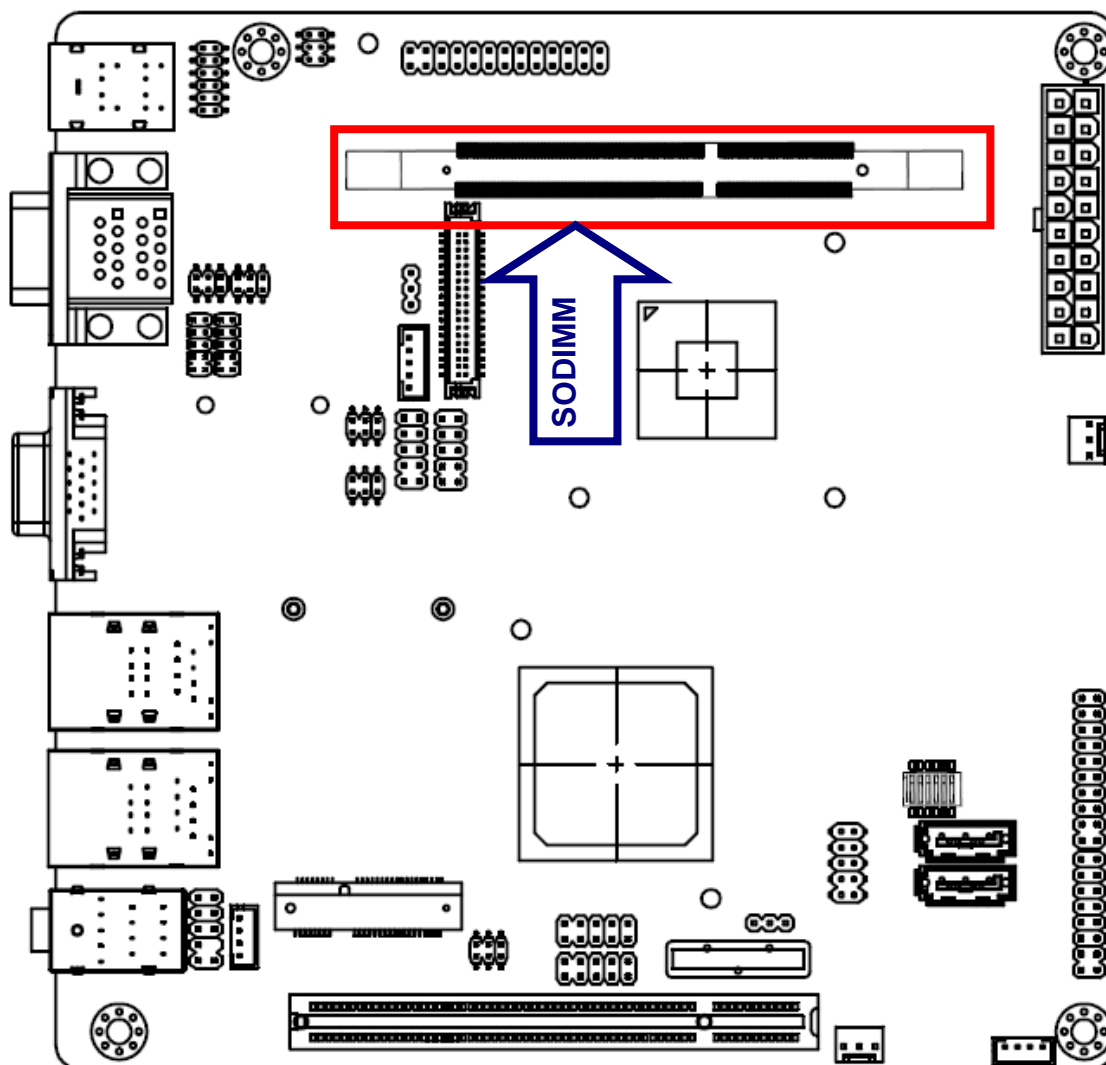

Make sure to unplug the power supply before adding or removing SODIMMs or other system components. Failure to do so may cause severe damage to both the board and the components.

- Locate the SODIMM socket on the board.
- Hold two edges of the SODIMM module carefully. Keep away of touching its connectors.
- Align the notch key on the module with the rib on the slot.

EMX-PNV

- Firmly press the modules into the socket automatically snaps into the mounting notch. Do not force the SODIMM module in with extra force as the SODIMM module only fit in one direction.

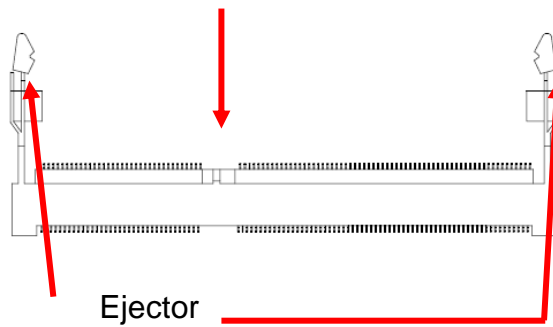
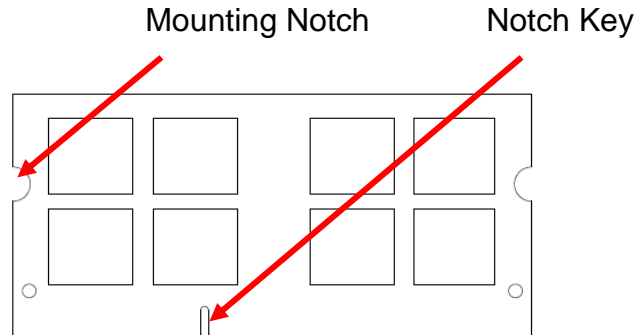

204-pin DDR3 SODIMM

- To remove the SODIMM modules, push the two ejector tabs on the slot outward simultaneously, and then pull out the SODIMM module.



Note:

- (1) Please do not change any SDRAM parameter in BIOS setup to increase your system's performance without acquiring technical information in advance.
- (2) Static electricity can damage the electronic components of the computer or optional boards. Before starting these procedures, ensure that you are discharged of static electricity by touching a grounded metal object briefly.

2.3 Jumper and Connector List

You can configure your board to match the needs of your application by setting jumpers. A jumper is the simplest kind of electric switch.

It consists of two metal pins and a small metal clip (often protected by a plastic cover) that slides over the pins to connect them. To “close” a jumper you connect the pins with the clip. To “open” a jumper you remove the clip. Sometimes a jumper will have three pins, labeled 1, 2, and 3. In this case, you would connect either two pins.

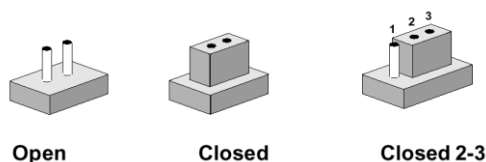

The jumper settings are schematically depicted in this manual as follows:



A pair of needle-nose pliers may be helpful when working with jumpers.

Connectors on the board are linked to external devices such as hard disk drives, a keyboard, or floppy drives. In addition, the board has a number of jumpers that allow you to configure your system to suit your application.

If you have any doubts about the best hardware configuration for your application, contact your local distributor or sales representative before you make any changes.

The following tables list the function of each of the board's jumpers and connectors.

Jumpers		
Label	Function	Note
JBAT1	Clear CMOS	3 x 1 header
JFTP1	Miscellaneous setting connector	8 x 2 header, pitch 2.54 mm
JP1	Serial port 3 pin 9 signal select – Ring, +5V, +12V power select	3 x 2 header, pitch 2.0 mm
JP2	Serial port 4 pin 9 signal select – Ring, +5V, +12V power select	3 x 2 header, pitch 2.0 mm
JP3	Serial port 2 pin 9 signal select – Ring, +5V, +12V power select	3 x 2 header, pitch 2.0 mm
JP4	Serial port 1 pin 9 signal select – Ring, +5V, +12V power select	3 x 2 header, pitch 2.0 mm
JP5	Serial port 2 in RS232/422/485	3 x 2 header, pitch 2.0 mm
JP6	Serial port 2 in RS232/422/485	6 x 2 header, pitch 2.0 mm

Connectors		
Label	Function	Note
BT1	Battery slot connector	
CF1	CF card slot connector	
CN1	Speaker out connector	4 x 1 wafer, pitch 2.0mm
CN2	USB connector 4 & 5	5 x 2 header, pitch 2.54 mm
CN3	USB connector 6 & 7	5 x 2 header, pitch 2.54 mm
CN4	SPI connector	3 x 2 header, pitch 2.0 mm
CN5	Serial port 4 connector	5 x 2 header, pitch 2.54 mm
CN6	LCD inverter connector	5 x 1 wafer, pitch 2.0mm
CN7	Serial port 3 connector	5 x 2 header, pitch 2.54 mm
CN8	CD-ROM Audio connector	4 x 1 wafer, pitch 2.0mm
CN9	Front audio connector	5 x 2 header, pitch 2.54 mm
CN10	USB connector 0 & 1 (Co-lay with LAN1)	
CN11	USB connector 2 & 3 (Co-lay with LAN2)	
CN12	PS/2 keyboard & mouse connector	
CN13	Audio connector	
COM1	Serial port 1/ 2 connector	D-sub 9-pin, male
DIMM1	DIMM slot	
DIO1	General purpose I/O connector	10 x 2 header, pitch 2.54 mm
FAN1	CPU fan connector	3 x 1 wafer, pitch 2.54mm
FAN2	System fan connector	3 x 1 wafer, pitch 2.54mm
JVGA1	VGA power connector	5 x 2 header, pitch 2.0 mm
JVGA2	VGA connector	5 x 2 header, pitch 2.0 mm
LPT1	Print port connector	13 x 2 header, pitch 2.54mm
LVDS1	LVDS connector	20 x 2 header, pitch 1.25mm
PCI1	PCI slot	
PCIE1	PCIE slot	
PWR1	ATX power connector	10 x 2 wafer, pitch 2.54mm
SATA1	Serial ATA connector 1	
SATA2	Serial ATA connector 2	
TOUCH1	Touch panel connector	5 x 2 header, pitch 2.54 mm
TSW1	4W/ 5W/ 8W power mode select	DIP-SW, 6P
VGA1	VGA connector	D-sub 15-pin, female
VR1	LCD backlight brightness adjustment	3 x 1 header, pitch 2.54mm

2.4 Setting Jumpers & Connectors

2.4.1 Clear CMOS (JBAT1)

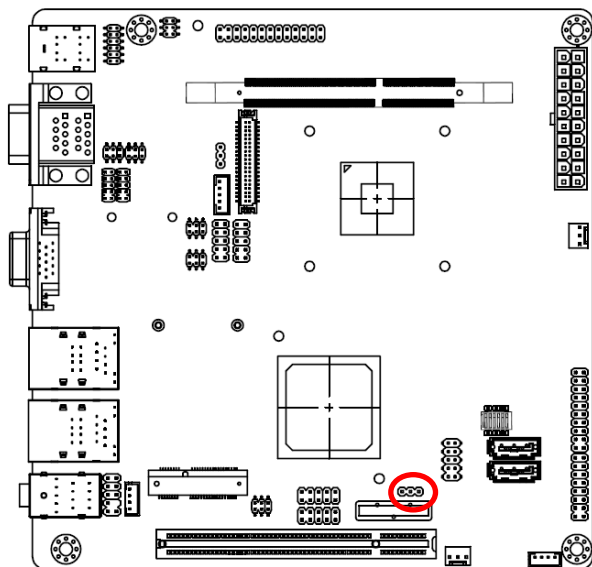

Protect*

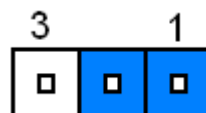

Clear CMOS



* Default

2.4.2 Miscellaneous setting connector (JFTP1)

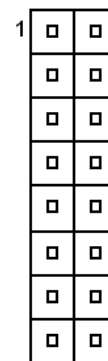
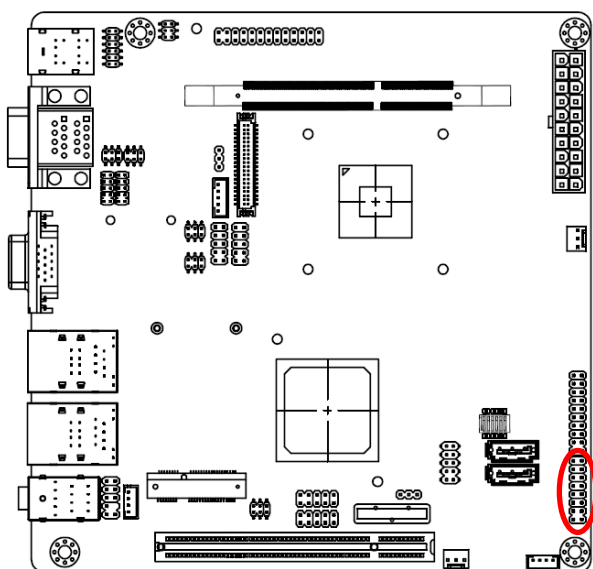

* Default

Note: AUX TIN is usually a port you can add an auxiliary sensor to, to monitor HDD or Chipset temperatures.

Signal	PIN	PIN	Signal
AUX TIN	1	2	SB_LED+
	3	4	GND
+3.3V	5	6	BUZZER
HDD_LED	7	8	
RESET	9	10	PWR_LED+
	11	12	GND
PWRBTN	13	14	Open: AT
	15	16	Short: ATX

2.4.3 Serial port 3/ 4/ 2/ 1 pin 9 signal select (JP1/ JP2/ JP3/ JP4)

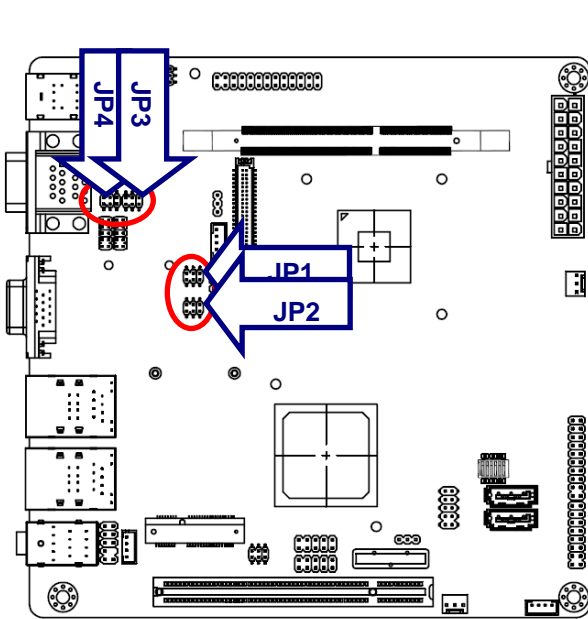

* Default

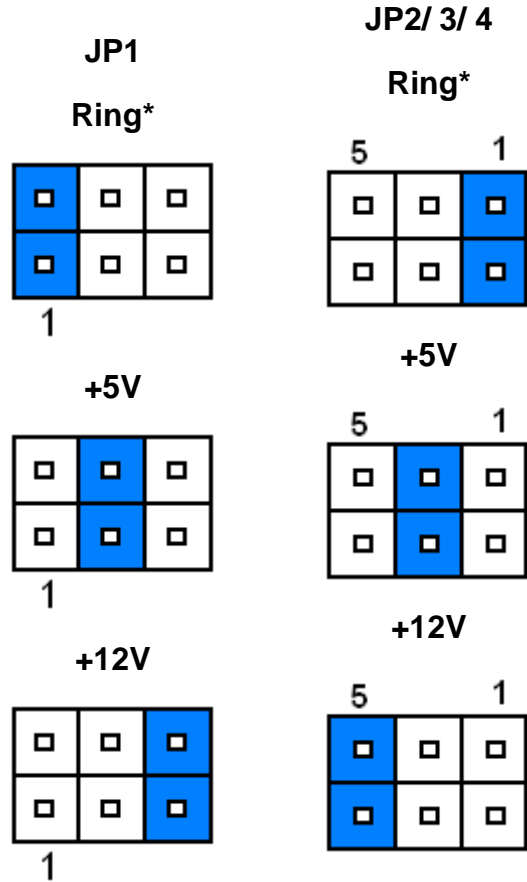

2.4.4 Serial Port 2 Connector in RS232/422/485 (JP5)

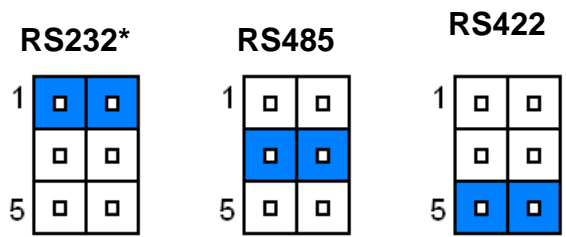
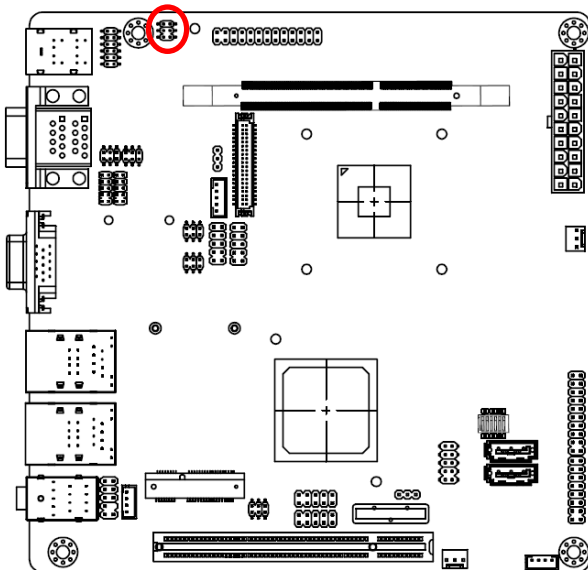

Signal	PIN	PIN	Signal
RXD232	1	2	RXDB
RXD485	3	4	RXDB
RXD422	5	6	RXDB

2.4.5 Serial Port 2 Connector in RS232/422/485 (JP6)

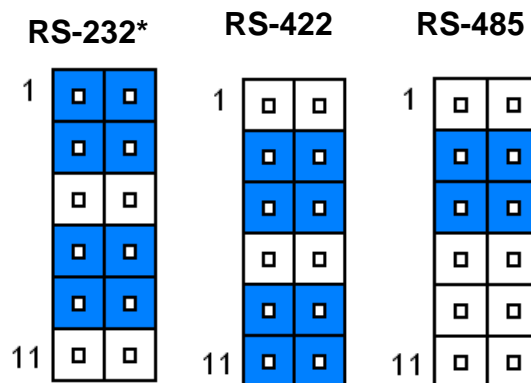
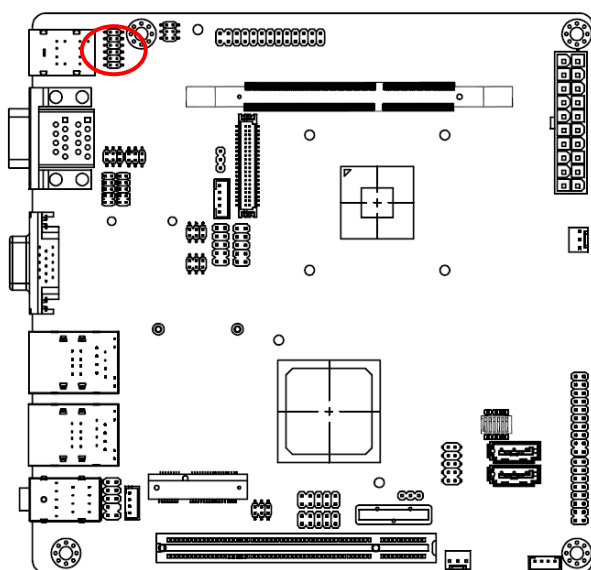

Signal	PIN	PIN	Signal
DCD#B	1	2	RXDB
CM2-1	3	4	CM2-2
485TX-	5	6	422RX+
TXDB	7	8	DTR#B
CM2-3	9	10	CM2-4
485TX+	11	12	422RX-

***Default**

Note: COM2 is available in RS-232 mode by default setting. For using COM2 in 422/485 Mode, please adjust both JP5 and JP6 with corresponding Jumper settings.

2.4.6 ATX power connector (PWR1)

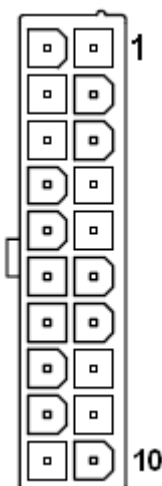
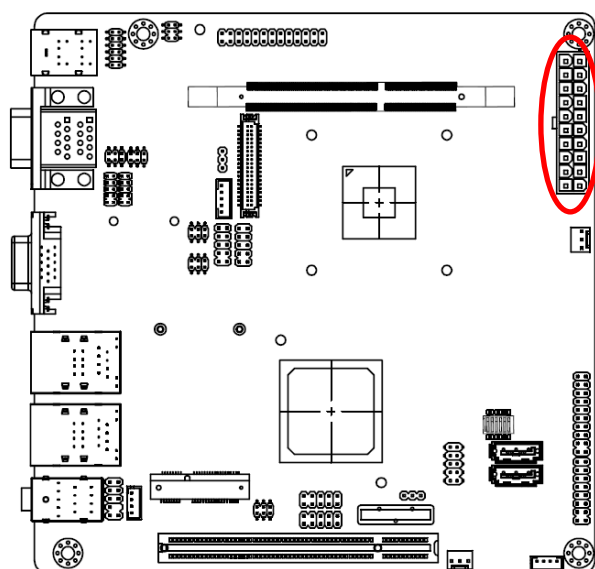

Signal	PIN	PIN	Signal
+3.3V	11	1	+3.3V
-12V	12	2	+3.3V
GND	13	3	GND
PS_ON#	14	4	+5V
GND	15	5	GND
GND	16	6	+5V
GND	17	7	GND
NC	18	8	NC
+5V	19	9	+5V
+5V	20	10	+12V

2.4.7 Speaker out connector (CN1)

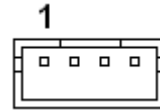
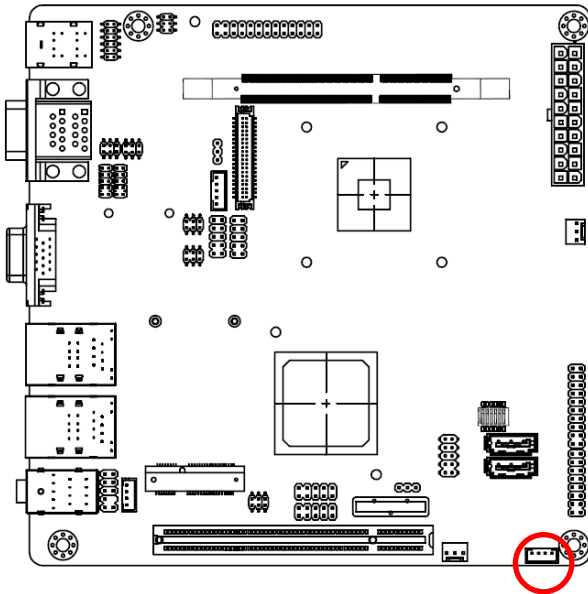

Signal	PIN
AMP_OUT_LP	1
AMP_OUT_LN	2
AMP_OUT_RN	3
AMP_OUT_RP	4

2.4.8 USB connector 4 & 5/ 6 & 7 (CN2/ CN3)

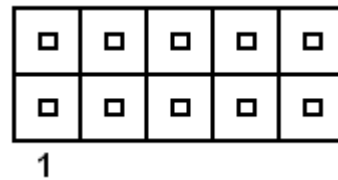
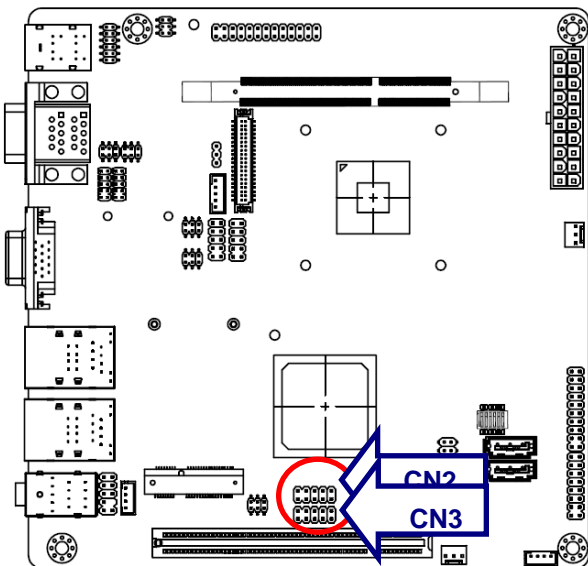

Signal	PIN	PIN	Signal
+5V	1	2	GND
P4-/P6-	3	4	GND
P4+/P6+	5	6	P5+/P7+
GND	7	8	P5-/P7-
GND	9	10	+5V

2.4.9 SPI connector (CN4)

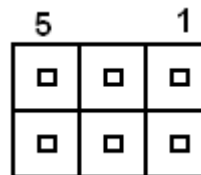
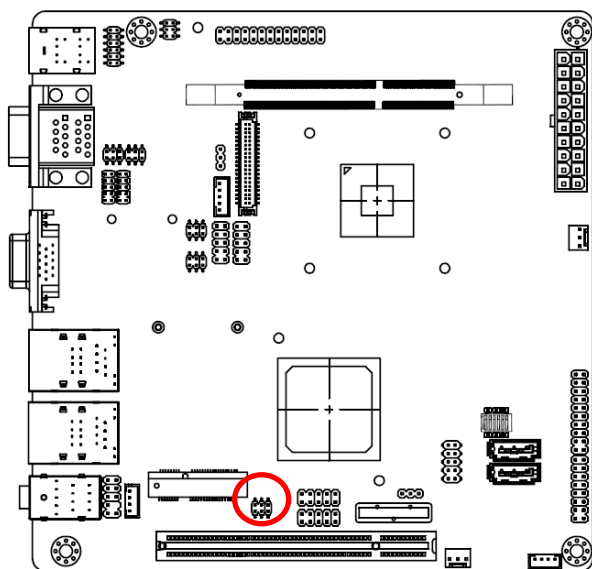

Signal	PIN	PIN	Signal
+3.3V	1	2	GND
SPI_CS0#	3	4	SPI_CLK
SPI_SO	5	6	SPI_SI

2.4.10 Serial port 4/ 3 connector (CN5/ CN7)

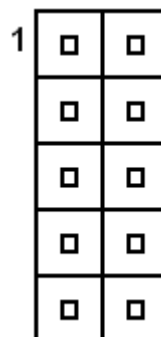
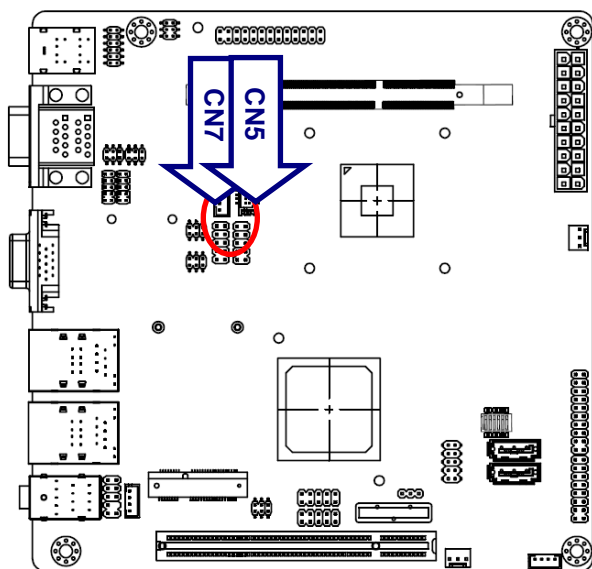

Signal	PIN	PIN	Signal
DCD	1	2	RxD
TxD	3	4	DTR
GND	5	6	DSR
RTS	7	8	CTS
RI	9	10	NC

2.4.11 LCD backlight brightness adjustment (VR1)

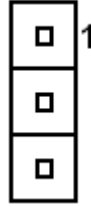
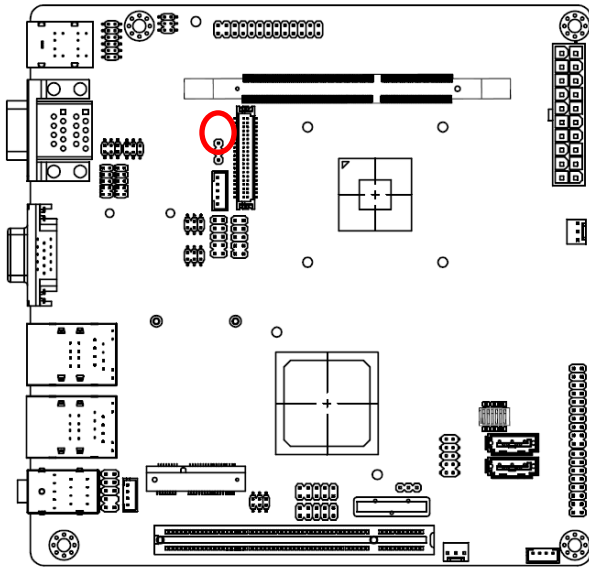

Signal	PIN
+5V	1
BRIGHT	2
GND	3

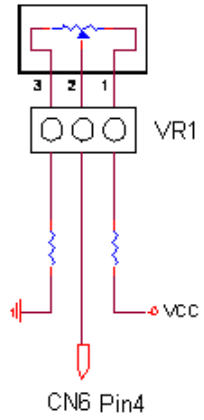

Variation Resistor
(Recommended: 4.7KΩ,
>1/16W)

2.4.12 LCD Inverter Connector (CN6)

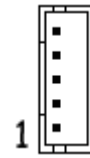
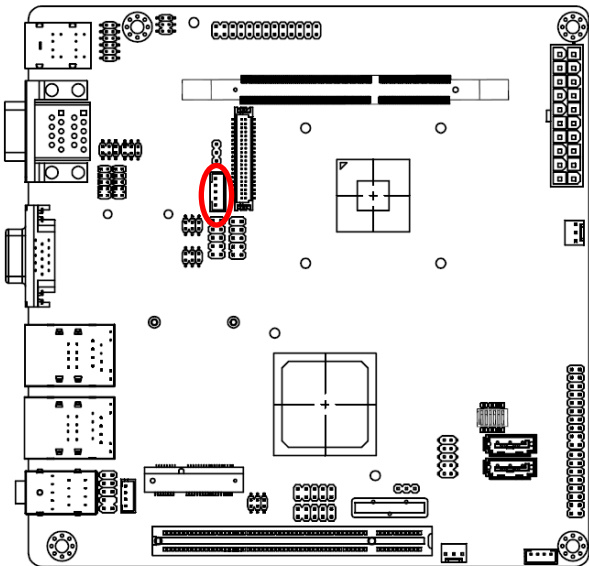

Signal	PIN
+5V	5
BRIGHT	4
LBKLT_EN	3
GND	2
+12V	1



Note:

For inverters with adjustable Backlight function, it is possible to control the LCD brightness through the VR signal controlled by **VR1**. Please see the **VR1** section for detailed circuitry information

2.4.12.1 Signal Description – LCD Inverter Connector (CN6)

Signal	Signal Description
BRIGHT	V _{adj} = 0.75V ~ 4.25V (Recommended: 4.7KΩ, >1/16W)
LBKLT_EN	LCD backlight ON/OFF control signal

2.4.13 CD-ROM Audio Connector (CN8)

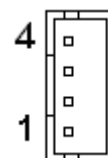
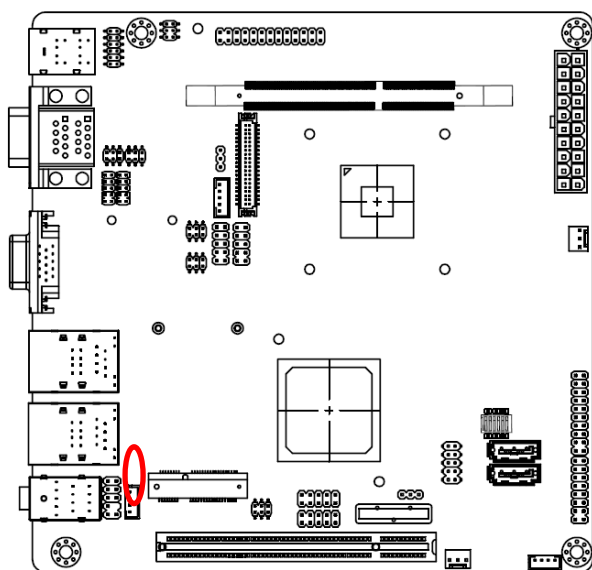

Signal	PIN
R	4
GND	3
L	2
GND	1

2.4.14 Front audio connector (CN9)

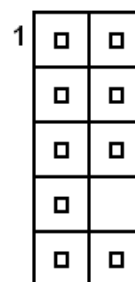
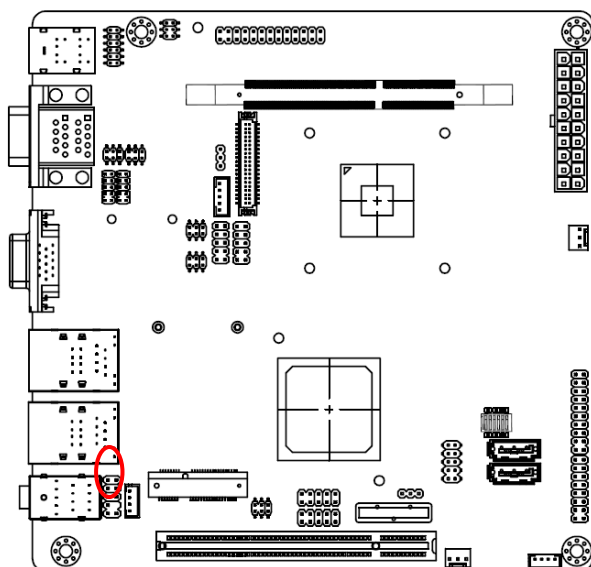

Signal	PIN	PIN	Signa
MIC2_L	1	2	GND
MIC2_R	3	4	+3.3V
LINE2_R	5	6	MIC2_JD
SENSE_B	7		
LINE2_L	9	10	LINE2_JD

2.4.15 General purpose I/O connector (DIO1)

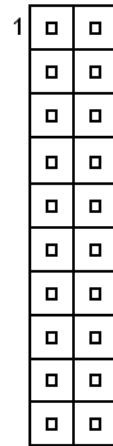
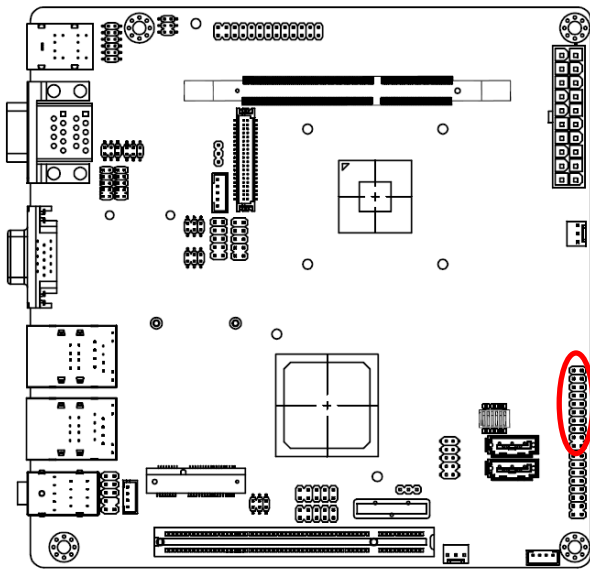

Signal	PIN	PIN	Signal
DI0	1	2	DO0
DI1	3	4	DO1
DI2	5	6	DO2
DI3	7	8	DO3
DI4	9	10	DO4
DI5	11	12	DO5
DI6	13	14	DO6
DI7	15	16	DO7
SMB_CLK	17	18	SMB_DAT
GND	19	20	+5V

2.4.16 CPU/System fan connector (FAN1/FAN2)

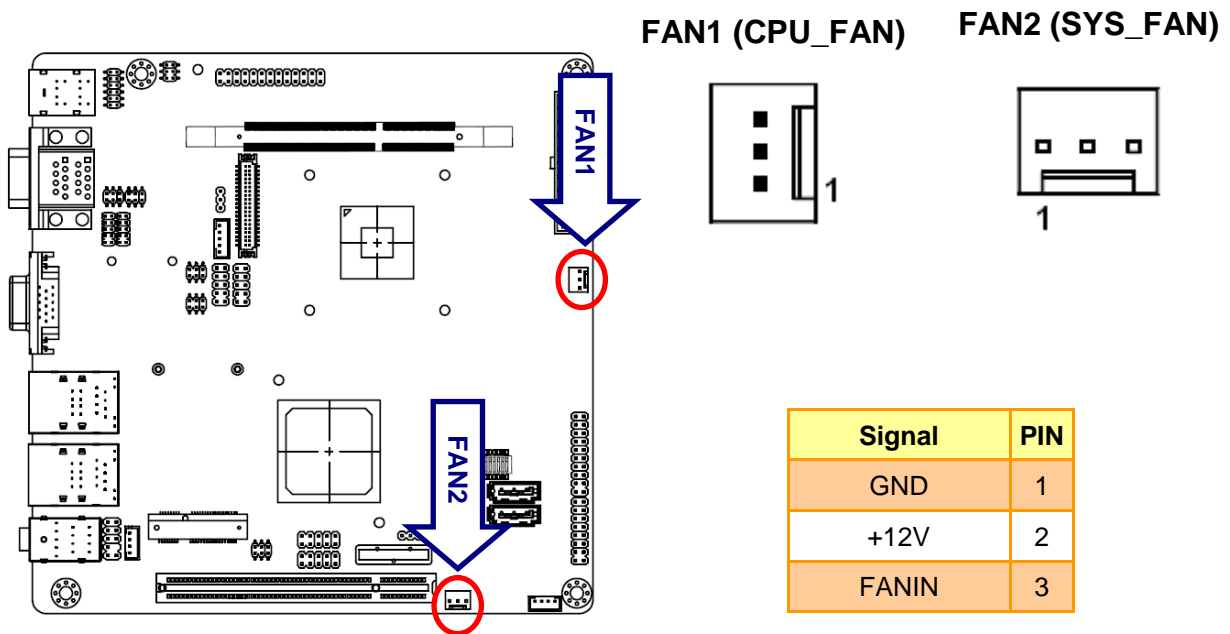

2.4.17 VGA power connector (JVGA1)

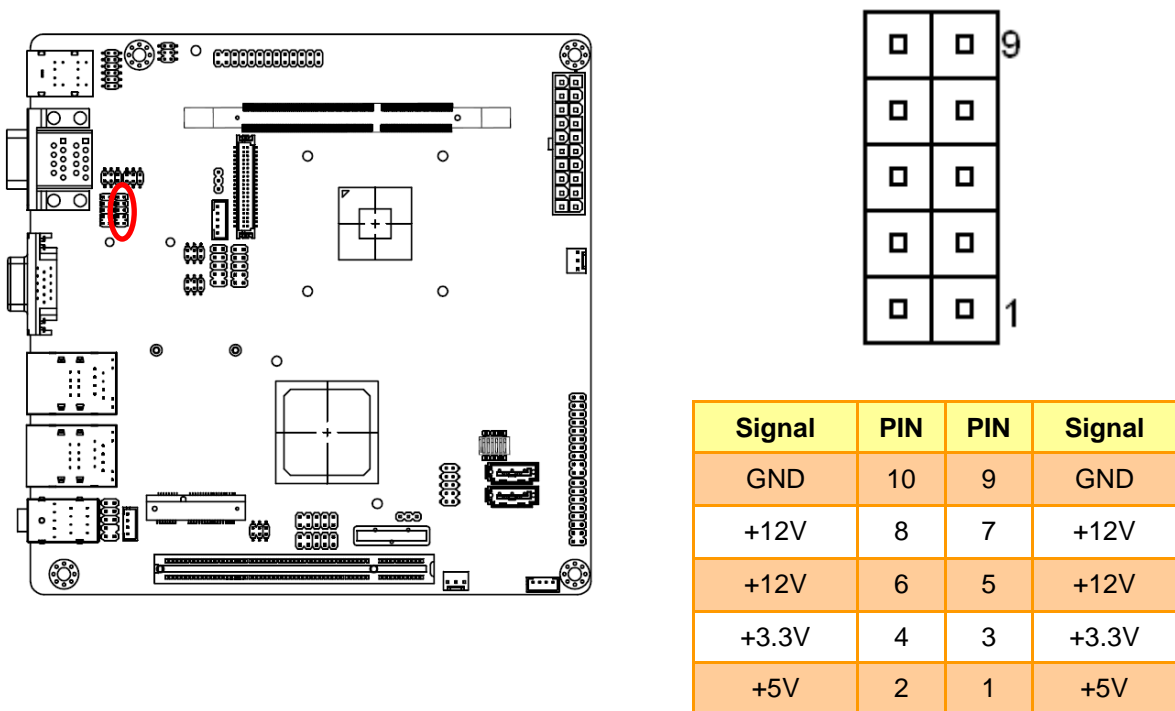

2.4.18 VGA connector (JVGA2)

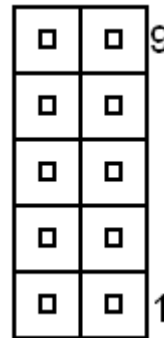
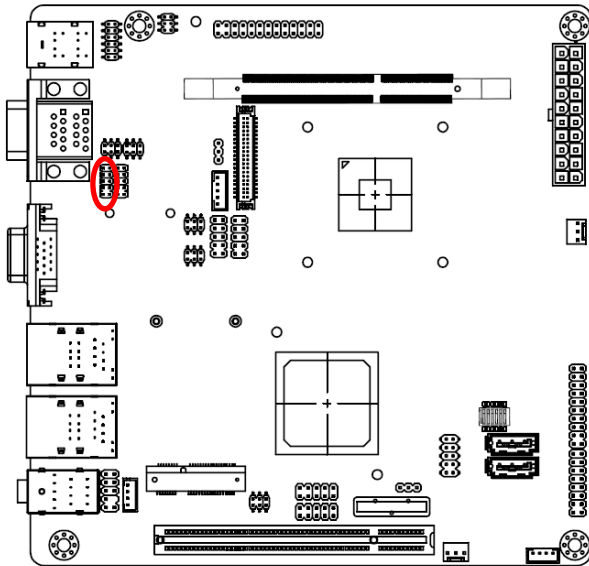

Signal	PIN	PIN	Signal
HS	10	9	VS
DAT	8	7	GND
CLK	6	5	B
GND	4	3	G
+5V	2	1	R

2.4.19 Print port connector (LPT1)

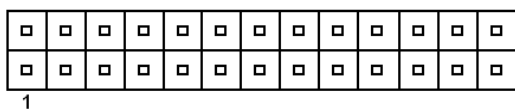
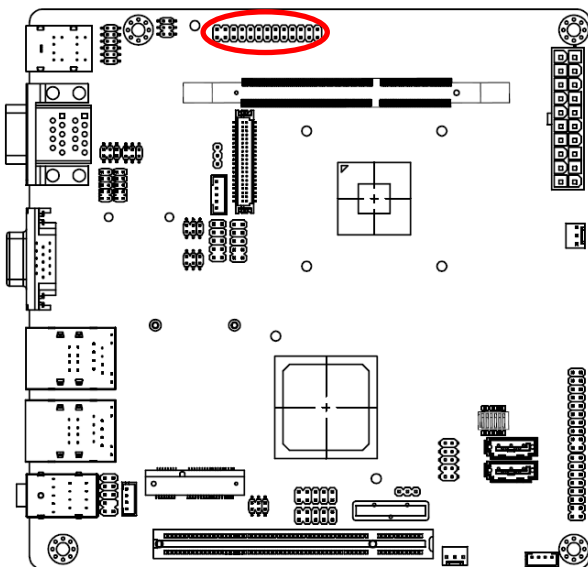

Signal	PIN	PIN	Signal
P_-STB	1	2	P_AFD#
PD0	3	4	P_ERR#
PD1	5	6	P_INIT#
PD2	7	8	P_SLIN#
PD3	9	10	GND
PD4	11	12	GND
PD5	13	14	GND
PD6	15	16	GND
PD7	17	18	GND
P_ACK#	19	20	GND
P_BUSY	21	22	GND
P_PE	23	24	GND
P_SLCT	25	26	GND

2.4.20 LVDS connector (LVDS1)

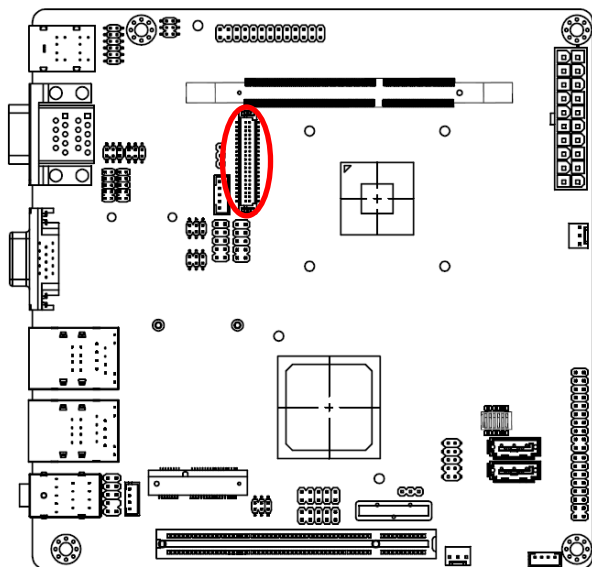

Signal	PIN	PIN	Signal
NC	39	40	NC
GND	37	38	GND
NC	35	36	LVDSA_CLK-
NC	33	34	LVDSA_CLK+
GND	31	32	GND
NC	29	30	NC
NC	27	28	NC
GND	25	26	GND
NC	23	24	NC
NC	21	22	NC
GND	19	20	GND
NC	17	18	LVDSA_D2-
NC	15	16	LVDSA_D2+
GND	13	14	GND
LVDSA_D1-	11	12	LVDSA_D0-
LVDSA_D1+	9	10	LVDSA_D0+
GND	7	8	GND
LCDSA_DDC_SC	5	6	LCDSA_DDC_SD
+3.3V	3	4	+5V
+3.3V	1	2	+5V

3. BIOS Setup

3.1 Introduction

The BIOS setup program allows users to modify the basic system configuration. In this following chapter will describe how to access the BIOS setup program and the configuration options that may be changed.

3.2 Starting Setup

The AMI BIOS™ is immediately activated when you first power on the computer. The BIOS reads the system information contained in the CMOS and begins the process of checking out the system and configuring it. When it finishes, the BIOS will seek an operating system on one of the disks and then launch and turn control over to the operating system.

While the BIOS is in control, the Setup program can be activated in one of two ways:

By pressing immediately after switching the system on, or

By pressing the key when the following message appears briefly at the bottom of the screen during the POST (Power On Self Test).

Press DEL to enter SETUP

If the message disappears before you respond and you still wish to enter Setup, restart the system to try again by turning it OFF then ON or pressing the "RESET" button on the system case. You may also restart by simultaneously pressing <Ctrl>, <Alt>, and <Delete> keys. If you do not press the keys at the correct time and the system does not boot, an error message will be displayed and you will again be asked to.

Press F1 to Continue, DEL to enter SETUP

3.3 Using Setup

In general, you use the arrow keys to highlight items, press <Enter> to select, use the PageUp and PageDown keys to change entries, press <F1> for help and press <Esc> to quit. The following table provides more detail about how to navigate in the Setup program using the keyboard.

Button	Description
↑	Move to previous item
↓	Move to next item
←	Move to the item in the left hand
→	Move to the item in the right hand
Esc key	Main Menu -- Quit and not save changes into CMOS Status Page Setup Menu and Option Page Setup Menu -- Exit current page and return to Main Menu
PgUp key	Increase the numeric value or make changes
PgDn key	Decrease the numeric value or make changes
+ key	Increase the numeric value or make changes
- key	Decrease the numeric value or make changes
F1 key	General help, only for Status Page Setup Menu and Option Page Setup Menu
(Shift) F2 key	Change color from total 16 colors. F2 to select color forward, (Shift) F2 to select color backward
F3 key	Calendar, only for Status Page Setup Menu
F4 key	Reserved
F5 key	Restore the previous CMOS value from CMOS, only for Option Page Setup Menu
F6 key	Load the default CMOS value from BIOS default table, only for Option Page Setup Menu
F7 key	Load the default
F8 key	Reserved
F9 key	Reserved
F10 key	Save all the CMOS changes, only for Main Menu

- **Navigating Through The Menu Bar**

Use the left and right arrow keys to choose the menu you want to be in.



Note: Some of the navigation keys differ from one screen to another.

- **To Display a Sub Menu**

Use the arrow keys to move the cursor to the sub menu you want. Then press <Enter>. A “>” pointer marks all sub menus.

3.4 Getting Help

Press F1 to pop up a small help window that describes the appropriate keys to use and the possible selections for the highlighted item. To exit the Help Window press <Esc> or the F1 key again.

3.5 In Case of Problems

If, after making and saving system changes with Setup, you discover that your computer no longer is able to boot, the AMI BIOS supports an override to the CMOS settings which resets your system to its defaults.

The best advice is to only alter settings which you thoroughly understand. To this end, we strongly recommend that you avoid making any changes to the chipset defaults. These defaults have been carefully chosen by both Award and your systems manufacturer to provide the absolute maximum performance and reliability. Even a seemingly small change to the chipset setup has the potential for causing you to use the override.

3.6 BIOS setup

Once you enter the AMI BIOS CMOS Setup Utility, the Main Menu will appear on the screen. The Main Menu allows you to select from several setup functions and exit choices. Use the arrow keys to select among the items and press <Enter> to accept and enter the sub-menu.

3.6.1 Main Menu and System information

This section allows you to record some basic hardware configurations in your computer and set the system clock.

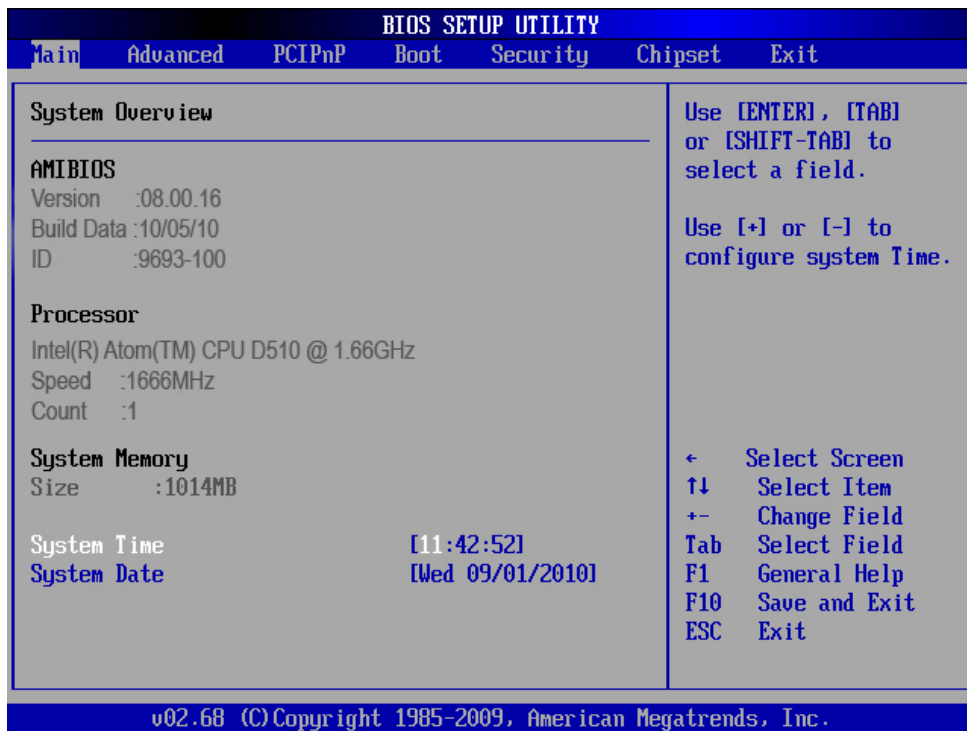

3.6.1.1 System Time

Use the system Date option to set the system date. Manually enter the day, month and year.

3.6.1.2 System Date

Use the system time option to set the system time. Manually enter the hours, minutes and seconds.



Note: The BIOS setup screens shown in this chapter are for reference purposes only, and may not exactly match what you see on your screen.

Visit the Avalue website (www.avalue.com.tw) to download the latest product and BIOS information.

3.6.2 Advanced Settings

This section allows you to configure your CPU and other system devices for basic operation through the following sub-menus.

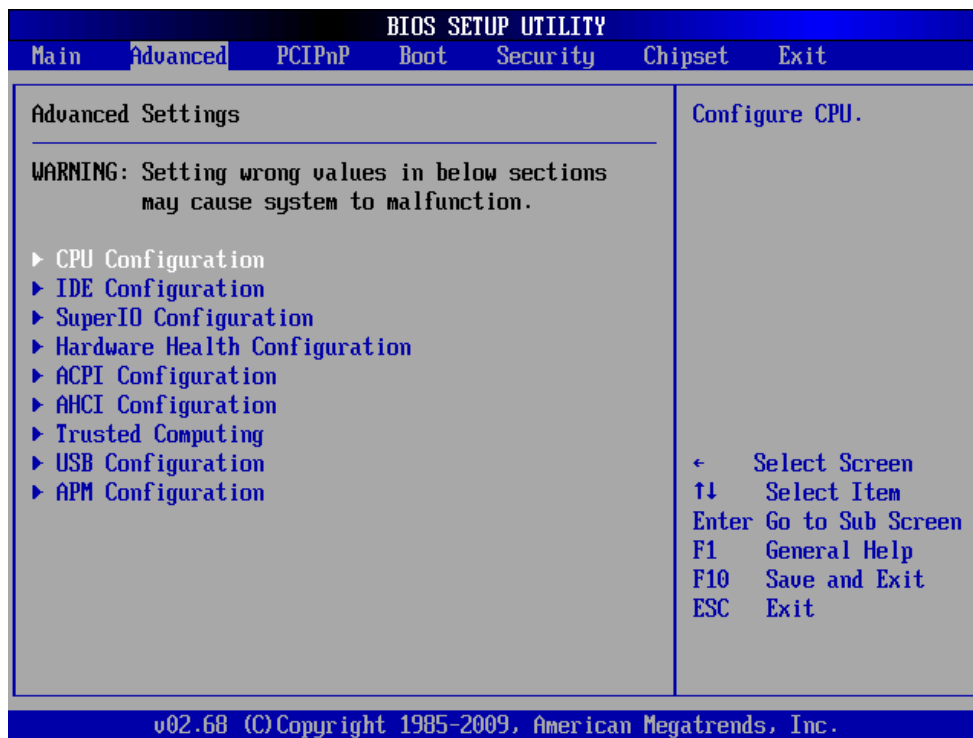

3.6.2.1 CPU configuration

Use the CPU configuration menu to view detailed CPU specification and configure the CPU.

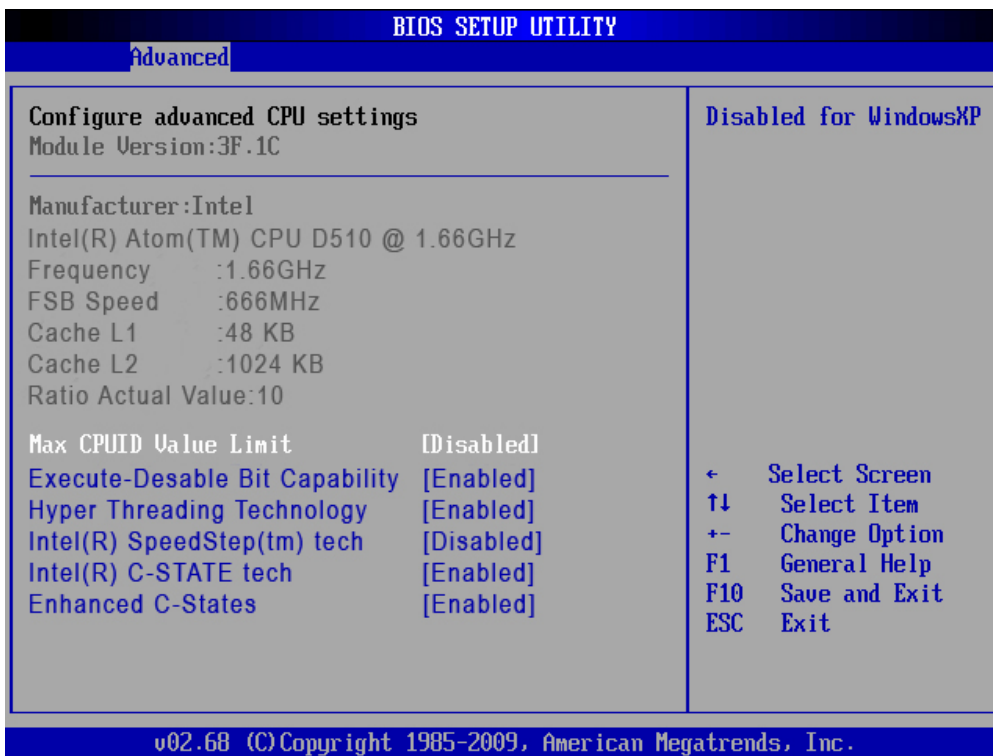

Item	Options	Description
Max CPUID Value Limit	Disabled, Enabled	This item allows you to limit CPUID maximum value.
Execute-Disable Bit Capability	Disabled, Enabled	This item allows you to enable or disable the No-Execution page protection technology.
Hyper Threading Technology	Disabled, Enabled	To enable or disable Intel® Hyper Threading technology. This item allows you improve parallelization of computations
Intel ® SpeedStep™ tech	Disabled, Enabled	This item allows you to enable or disable Intel ® SpeedStep™ tech for high performance and power-conservation
Intel ® C-STATE tech	Disabled, Enabled	This item allows you to enable or disable Intel ® C-STATE tech in order for the software to independently manage each core while the actual power management adheres to the platform and CPU shared resources
Enhanced C-States	Disabled, Enabled	This item allows you to enable or disable Enhanced C-States

3.6.2.2 IDE configuration

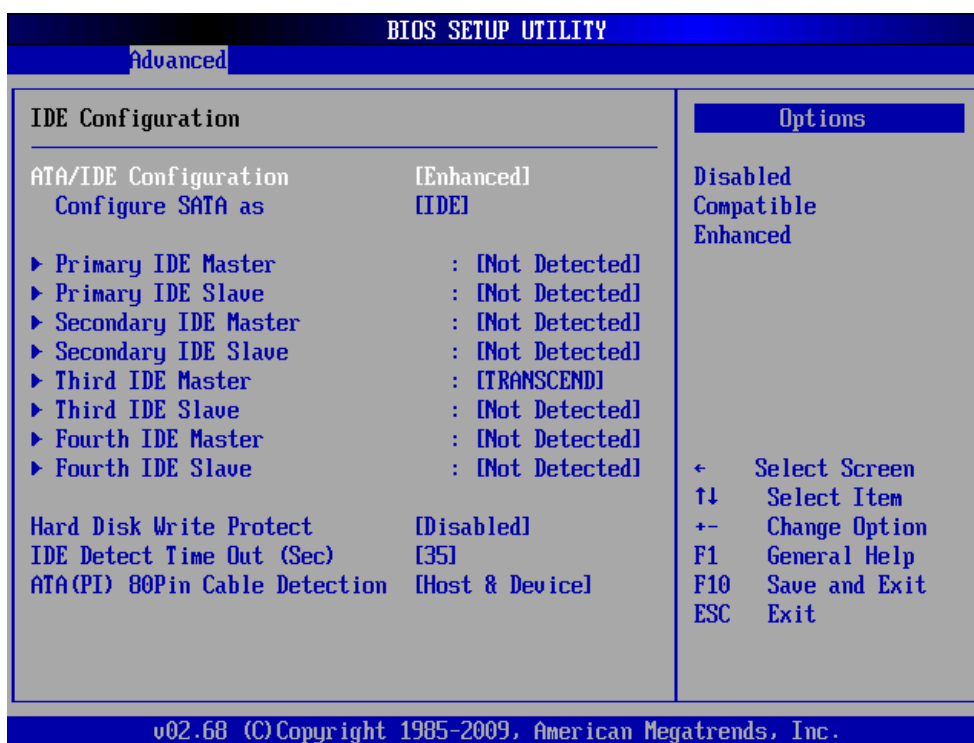

Item	Options	Description
ATA/ IDE Configuration	Disabled, Compatible, Enhanced	This can be configured as Disabled, Compatible or Enhanced.
Configure SATA as	IDE, AHCI	Use this option to configure the SATA port as an IDE drive or a SATA drive (AHCI mode)
Primary/ Secondary/ Third/ Fourth IDE Master	Disabled, Enabled	Use the IDE Master and IDE Slave configuration menu to view both primary and secondary IDE device details and configure the IDE devices connected to the system.
Primary/ Secondary/ Third/ Fourth IDE Slave	Disabled, Enabled	Use the IDE Master and IDE Slave configuration menu to view both primary and secondary IDE device details and configure the IDE devices connected to the system.
Hard Disk Write Protect	Disabled, Enabled	Disable/ Enable device write protection. This will effective only if device is accessed through BIOS.
IDE Detect Time Out (Sec)	0/ 5/ 10/ 15/ 20/ 25/ 30/ 35	This allows you to select the time out value for detecting ATA/ ATAPI devices.
ATA (PI) 80Pin Cable Detection	Host & Device, Host, Device	This item allows you to select ATA cable detection mode.

3.6.2.3 Super I/O configuration

You can use this item to set up or change the Super IO configuration for FDD controllers, parallel ports and serial ports.

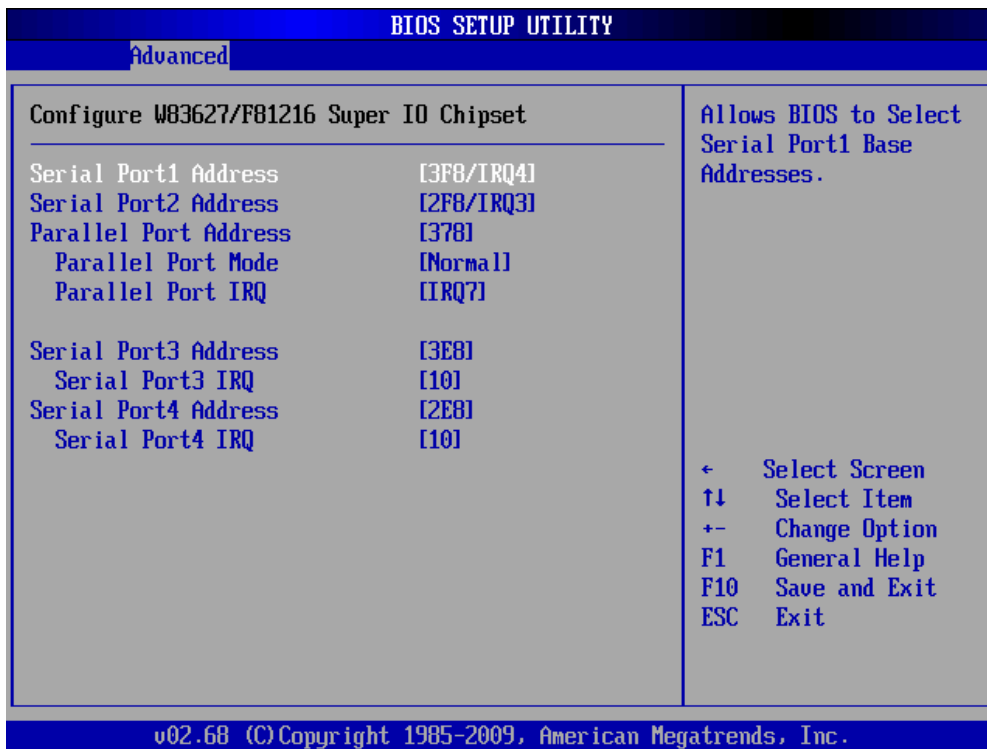

Item	Options	Description
Serial Port 1/ 2 Address	Disabled, 3F8/IRQ4, 2F8/IRQ3, 3E8/IRQ4, 2E8/IRQ3	This item allows you select serial port 1 ~ 2 of base addresses.
Serial Port 3/ 4 Address	Disabled, 3F8, 2F8, 3E8, 2E8, 2F0, 2E0	This item allows you select serial port 3 ~ 4 of base addresses.
Parallel Port Address	Disabled 378, 278, 3BC	Use the parallel Port Address option to select the parallel port base address.
Parallel Port Mode	Normal Bi-directional ECP, EPP ECP& EPP	Use Parallel Port Mode option to select the mode the parallel port operates in.
Parallel Port IRQ	IRQ5,IRQ7	Use the Parallel IRQ selection to set the parallel port interrupt address
Serial Port 3/ 4 IRQ	4, 9, 10, 11	Use the Serial Port3/4 IRQ option to select the interrupt address for serial port 3~4

3.6.2.4 Hardware Health configuration

This section shows the operating temperature, fan speed and system voltage.

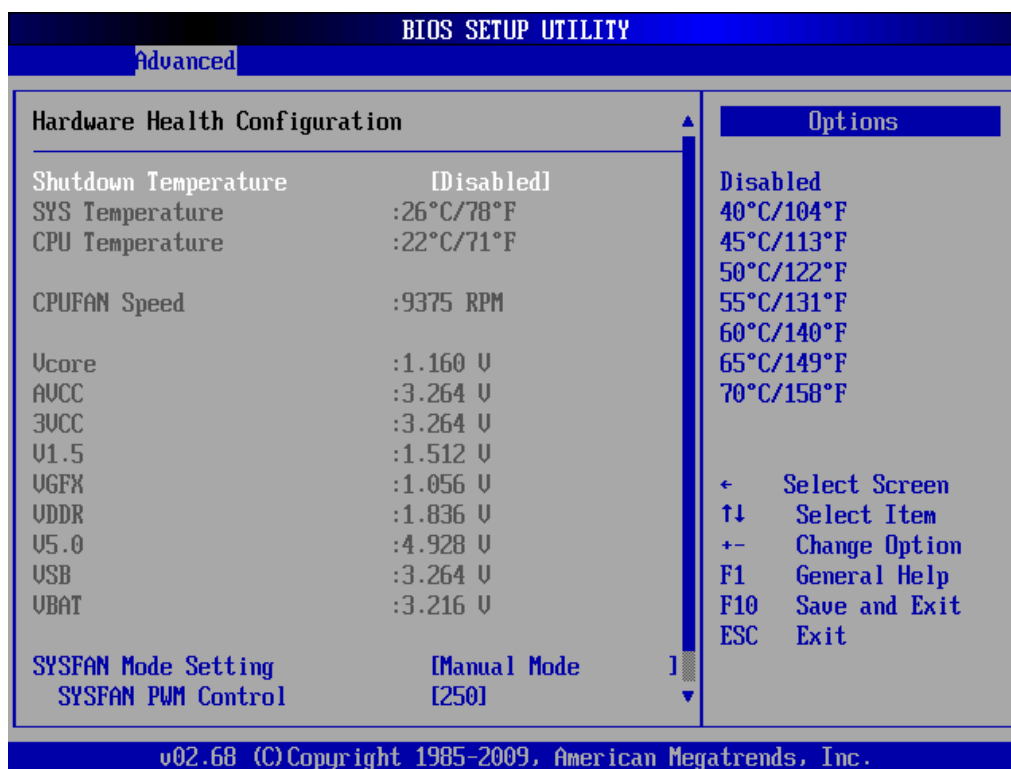

The following system temperature, fan speed and voltage are monitored.

System Temperature:

- Shutdown Temperature
- System Temperature
- CPU Temperature

Fan speed:

- CPUFAN speed

Voltage:

- Vcore
- AVCC
- 3VCC
- V1.5
- VGFX
- VDDR
- V5.0
- USB
- VBAT

3.6.2.5 ACPI configuration

Defines interfaces for hardware discovery, configuration, power management and monitoring.

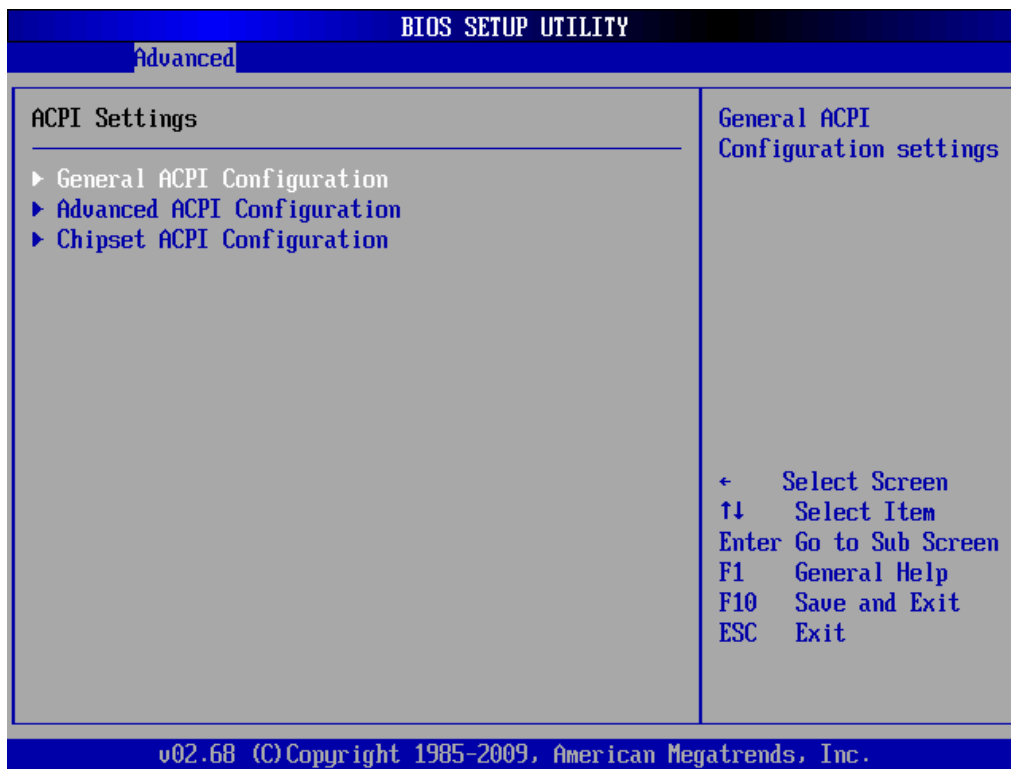

3.6.2.5.1 General ACPI settings

Use this **BIOS Menu** to select the ACPI state when the system is suspended.

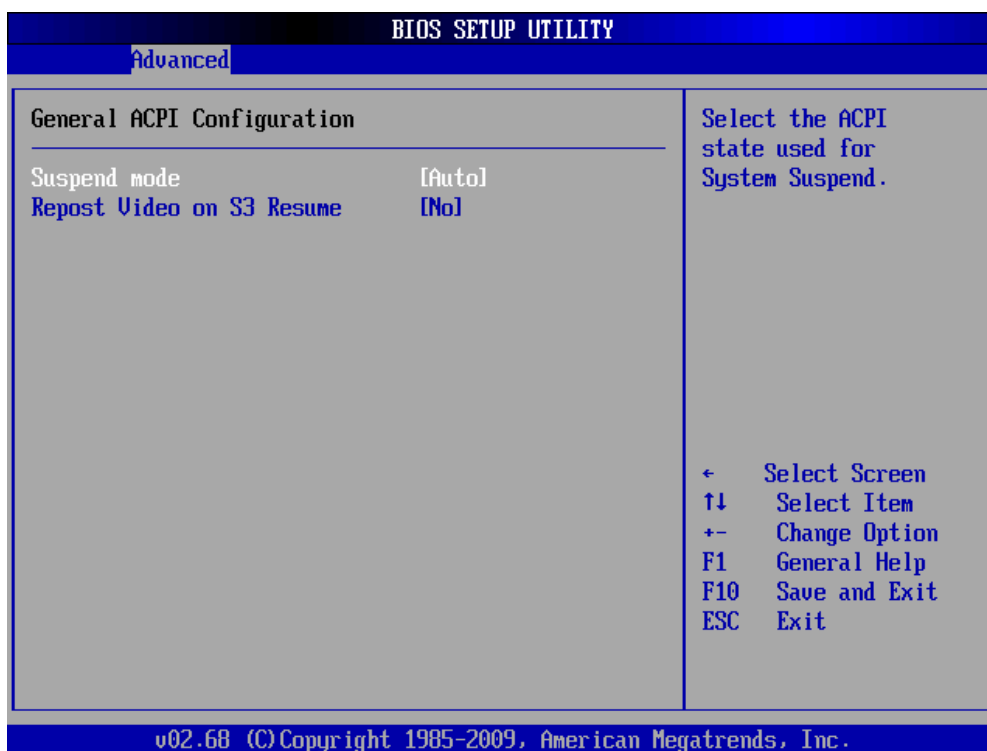

Item	Options	Description
Suspend Mode	S1 (POS), S3 (STR), Auto	Use the Suspend Mode option to specify the sleep state the system enters when it is not being used.
Repost Video on S3 Resume	No, Yes	This item allows you to invoke VA BIOS POST on S3/ STR resume.

3.6.2.5.2 Advanced ACPI Configuration

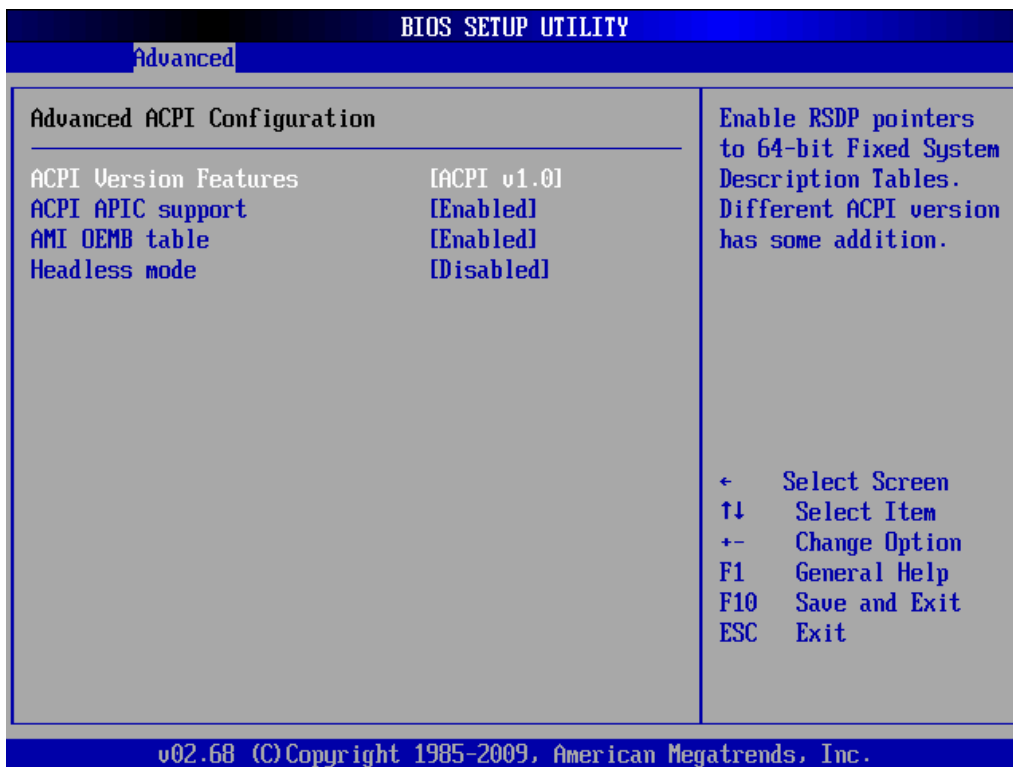

Item	Options	Description
ACPI Version Features	ACPI v1.0, ACPI v2.0, ACPI v3.0, ACPI v4.0	This item allows you to enable RSDP pointers to 64-bit fixed system description tables.
ACPI APIC support	Enabled, Disabled	to add a pointer to an ACPI APIC table in the RSDT (Root System Description Table)
AMI OEMB table	Enabled, Disabled	to add a pointer to an OEMB table in the RSDT table and the Extended System Description Table (XSDT).
Headless mode	Disabled, Enabled	Enable/ Disable Headless operation mode through ACPI.

3.6.2.5.3 Chipset ACPI configuration

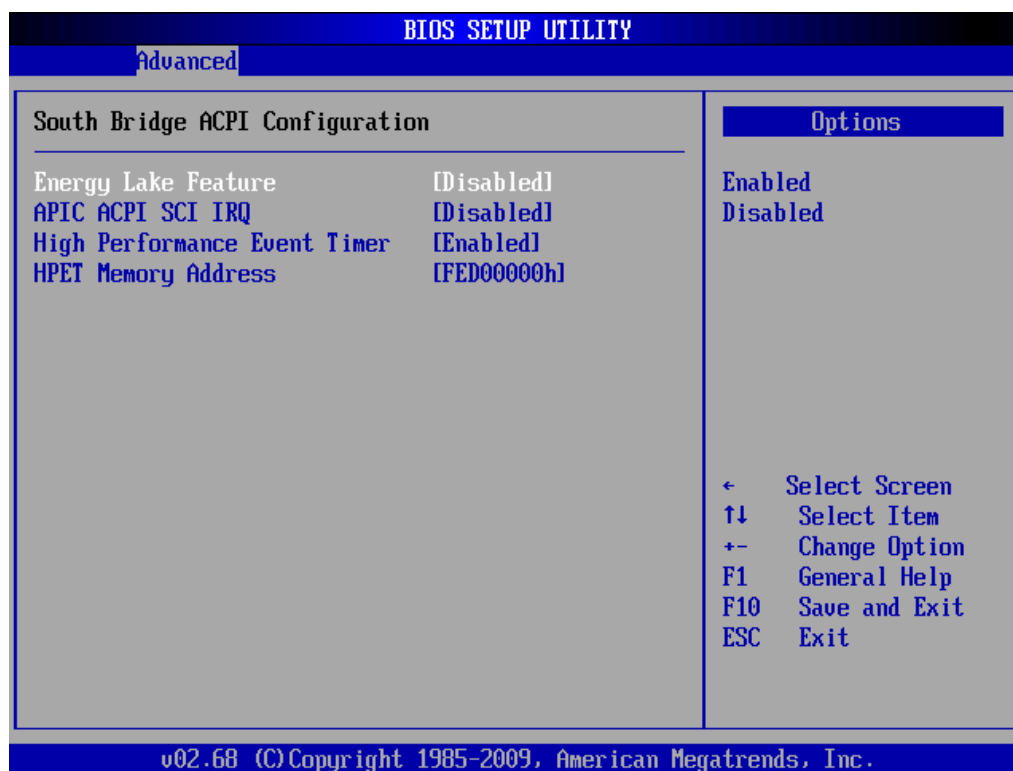

Item	Options	Description
Energy Lake Feature	Disabled, Enabled	This item allows energy lake feature mode selection.
APIC ACPI SCI IRQ	Disabled, Enabled	To enable/ disable APIC ACPI SCI IRQ.
High Performance Event Timer	Disabled, Enabled	This section helps to set high performance event timer.
HPET Memory Address	FES00000h, FES01000h, FES02000h	This item allows selecting HPET memory address.

3.6.2.6 AHCI Settings

This is a system memory structure to exchange data between host system memory and attached storage devices.

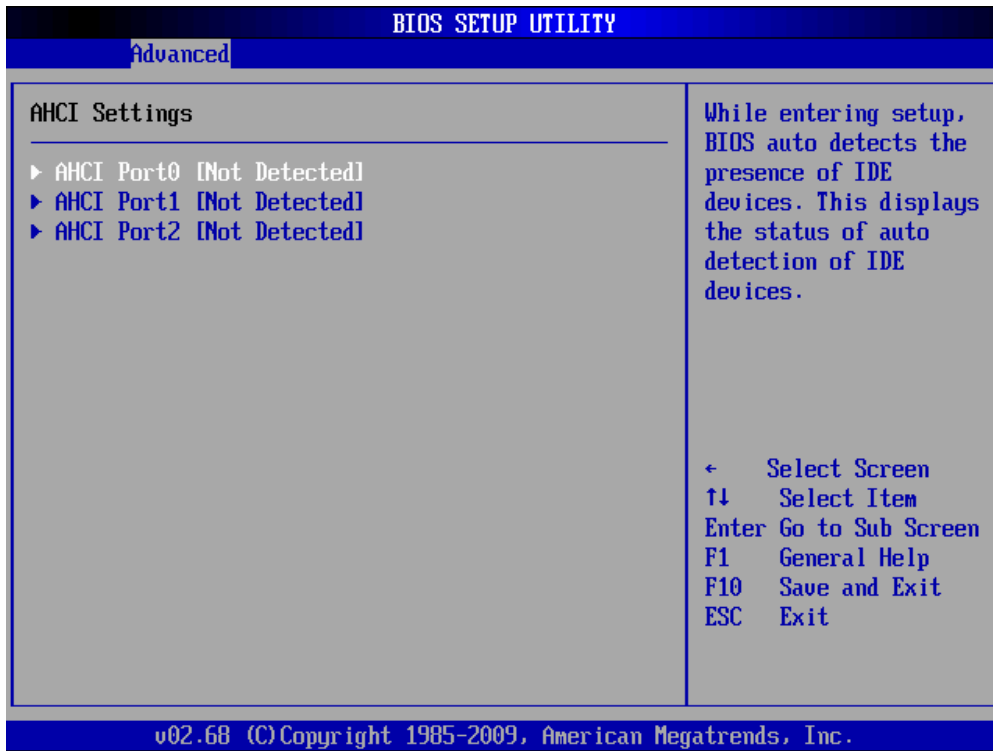

3.6.2.6.1 AHCI Port0

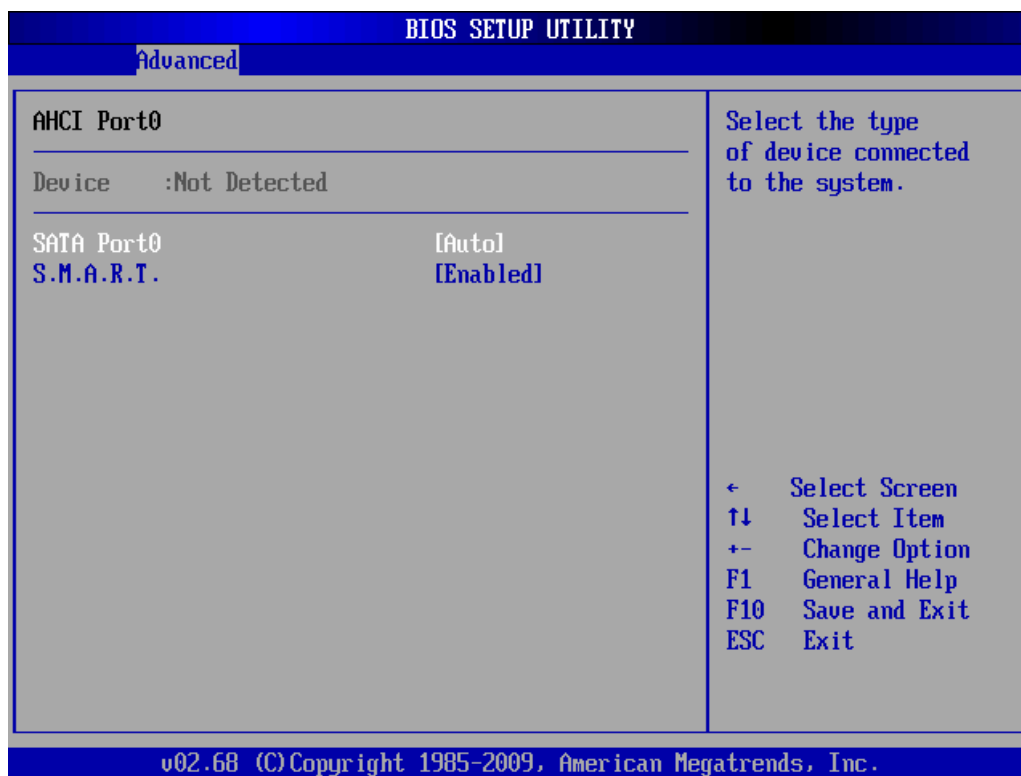

Item	Options	Description
SATA Port0	Auto, Not Installed	Serial port 0 mode selection.
S.M.A.R.T.	Disabled, Enabled	Select the smart monitoring, analysis, and reporting technology.

3.6.2.6.2 AHCI Port1

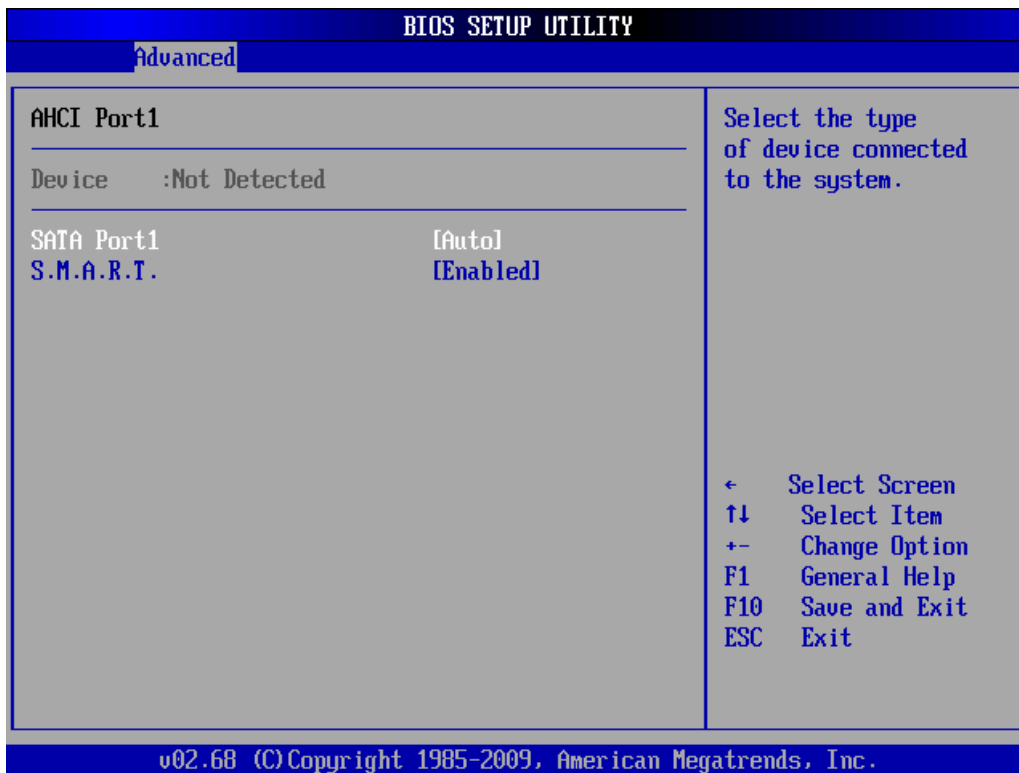

Item	Options	Description
SATA Port1	Auto, Not Installed	Serial port 1 mode select.
S.M.A.R.T.	Disabled, Enabled	Select the smart monitoring, analysis, and reporting technology.

3.6.2.6.3 AHCI Port2

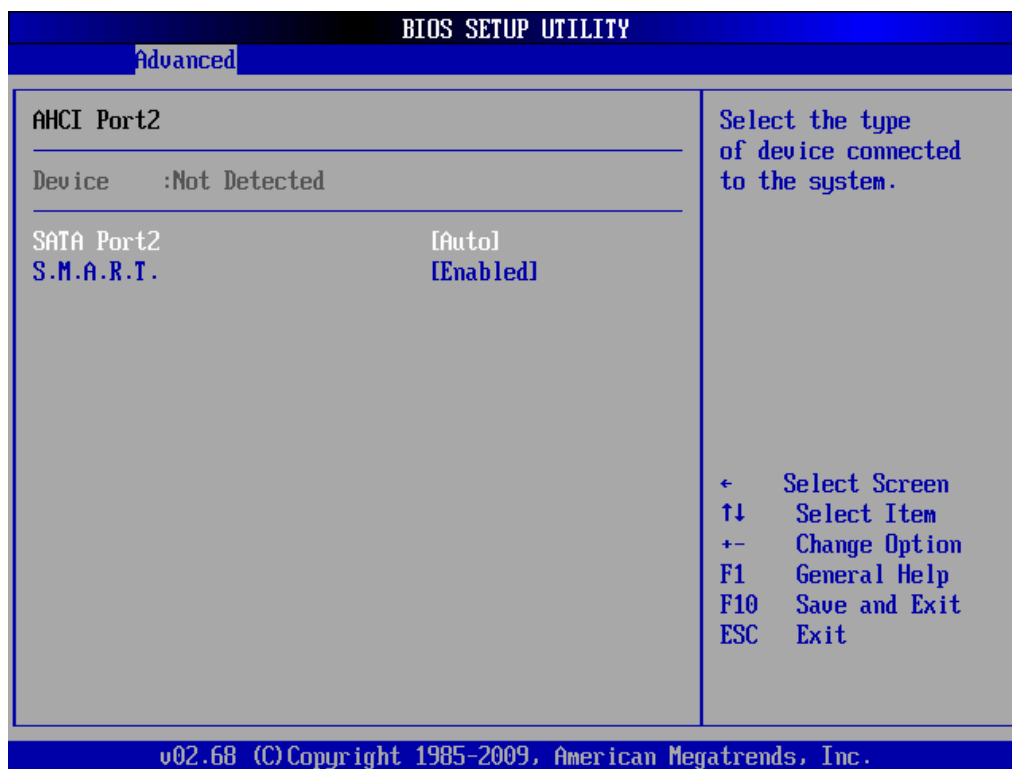

Item	Options	Description
SATA Port2	Auto, Not Installed	Serial port 2 mode select.
S.M.A.R.T.	Disabled, Enabled	Select the smart monitoring, analysis, and reporting technology.

3.6.2.7 Trusted Computing

To Enable/disable TPM TCG (TPM 1.1/1.2) supp in BIOS

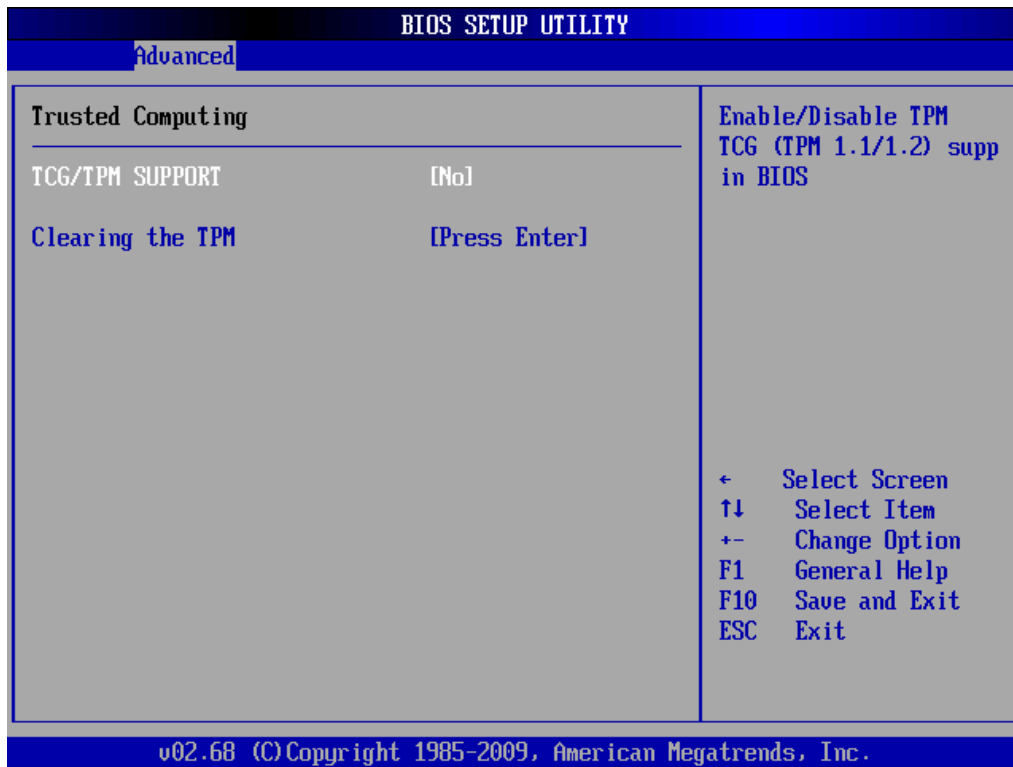

Item	Options	Description
TCG/TPM SUPPORT	Yes No	To enable or disable TCG/TPM
Clearing the TPM	[Press Enter]	Resets the TPM to an unowned state

3.6.2.8 USB configuration

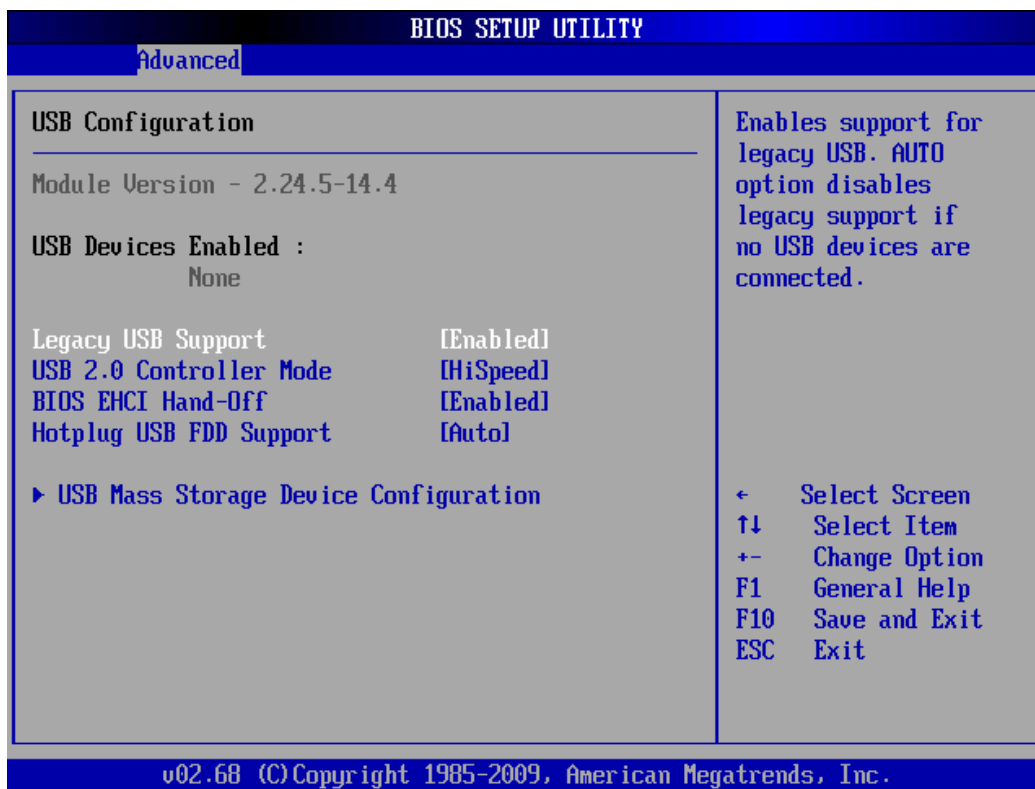

Item	Options	Description
Legacy USB Support	Enabled, Disabled, Auto	Use this option to enable USB mouse and USB keyboard support. Normally if this option is not enabled, attached USB mouse or USB keyboard is not available until a USB compatible operating system is fully booted with all USB drivers loaded. When this option is enabled, any attached USB mouse or USB keyboard can control the system even when there is no USB driver loaded onto the system.
USB 2.0 Controller Mode	HiSpeed (480Mbps), FullSpeed (12Mbps)	This item allows you to select HiSpeed (480Mbps) or FullSpeed (12Mbps).
BIOS EHCI Hand-Off	Enabled, Disabled	This is a workaround for OSs without EHCI hand-off support. The EHCI ownership change should be claimed by EHCI driver.
Hotplug USB FDD Support	Auto	The USB FDD is a slim type floppy disk drive (FDD) with a Universal Serial Bus (USB) interface.

3.6.2.8.1 USB mass storage configuration

This field appears if a USB drive is connected to one of the USB ports or connectors. If this option is selected a menu appears.

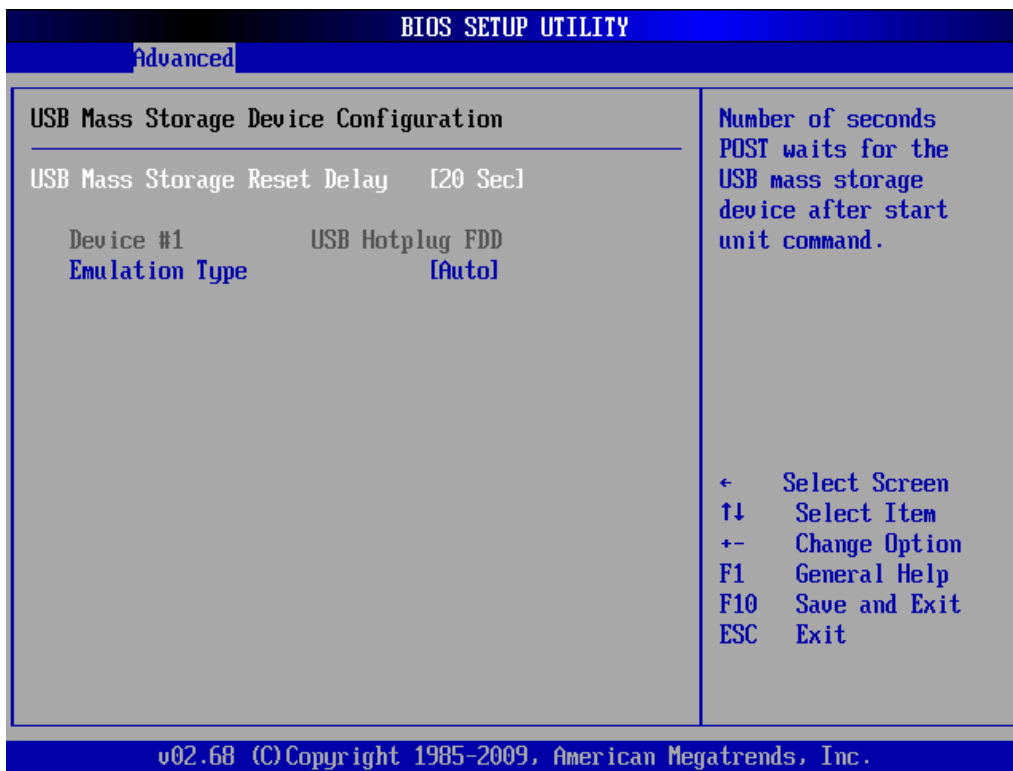

Item	Options	Description
USB Mass Storage Reset Delay	10, 20 30, 40	Time the BIOS will wait for the USB flash drive to initialize
Device #1 Emulation Type	Auto, Floppy, Forced FDD, Hard-Disk, CD-ROM.	This item allows you to set up mass storage devices.
Emulation type	If Auto, USB devices less than 530MB will be emulated as a floppy drive and the remaining as hard drive. Force FDD option can be used to force a FDD formatted drive to boot as FDD (Ex. ZIP drive).	

3.6.2.9 APM configuration

This enables the operating system to work with the BIOS to achieve power management.

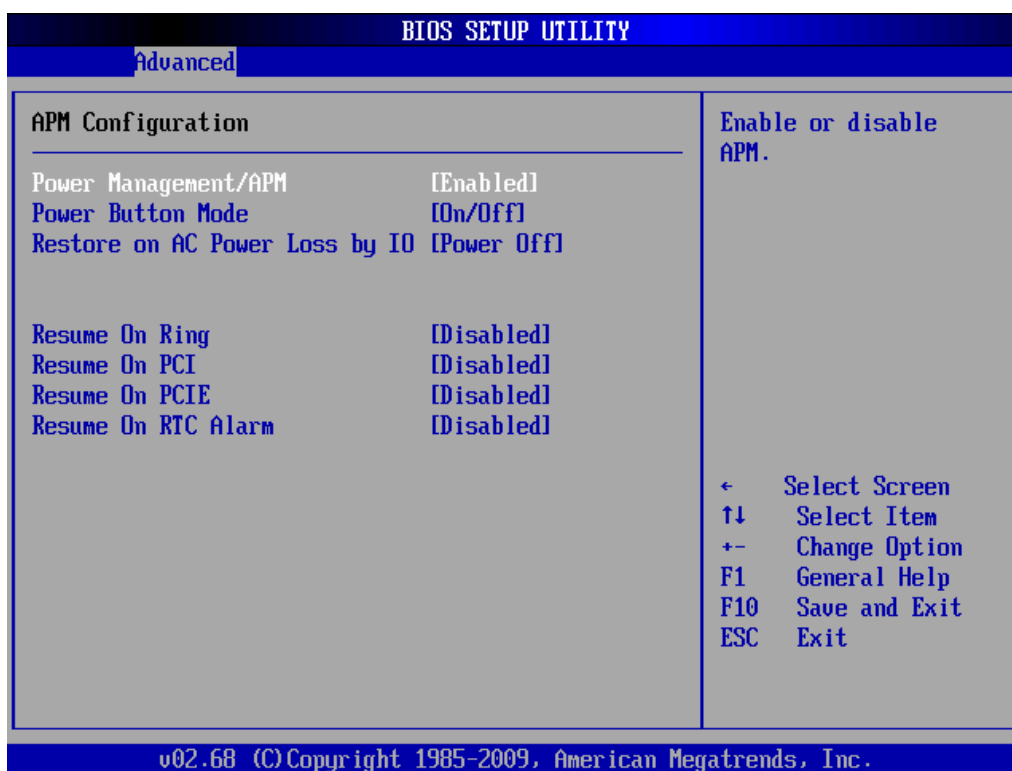

Item	Options	Description
Power Management/ APM	Enabled, Disabled	This item helps to select power management mode.
Power Button Mode	On/ Off, Suspend	This section allows you to select power button mode.
Restore on AC Power Loss by IO	Power On, Power Off, Last State	Use this to set up the system response after a power failure.
Resume On Ring	Disabled, Enabled	Use this option to enable activity on the RI (ring in) modem line to arouse the system from a suspended or standby state.
Resume on PCI	Disabled, Enabled	Use this option to enable activity on the PCI signal to arouse the system from a suspended or standby state.
Resume On PCIE	Disabled, Enabled	Use this option to enable activity on the PCIE signal to arouse the system from a suspended or standby state.
Resume On RTC Alarm	Disabled, Enabled	Use this option to specify the time the system should be roused from a suspend state.

3.6.3 PCIPnp

The settings in this section deal specifically with the PCI bus and Plug and Play (PnP) settings.

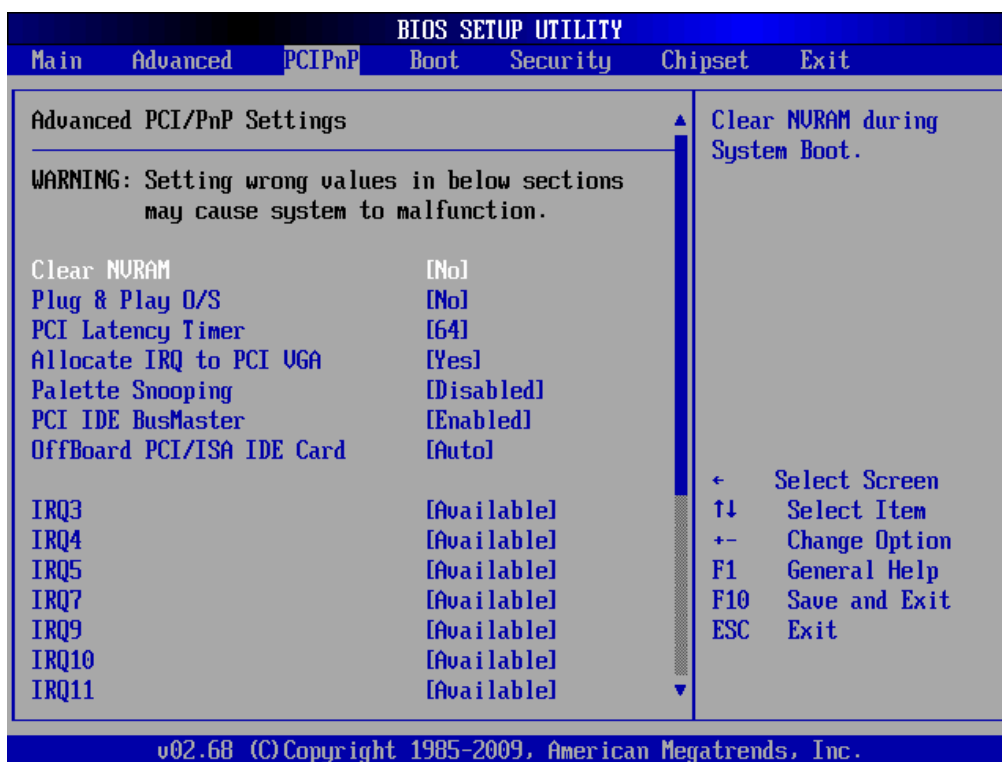

Item	Options	Description
Clear NVRAM	No, Yes	Set this value to force the BIOS clear Non-volatile Random Access Memory (NVRAM). The Original and Fail-Safe default setting is No.
Plug & Play O/S	No, Yes	Choose No to let the BIOS configure all devices in the system. This setting is appropriate when using a Plug and Play operating system.
PCI latency timer	32, 64, 96, 128, 160, 192, 224, 248	This feature controls how long a PCI device can hold the PCI bus before another takes over. It is set to 64 clock cycles.
Allocate IRQ to PCI VGA	No, Yes	If this item is enabled, an IRQ will be assigned to the PCI VGA graphics system. You set this value to No to free up an IRQ.
Palette Snooping	Enable/Disable	This item is designed to solve problems caused by some non-standard VGA card.
PCI IDE BusMaster	Enable/Disable	When set to enabled, BIOS uses PCI bus mastering for reading/writing to IDE drives.

<p>Off board PCI/ISA IDE Card</p>	<p>Auto, PCI Slot 1/ 2/ 3/ 4/ 5/ 6</p>	<p>Some PCI IDE cards may require this to be set to the PCI slot number that is holding the card. When set to auto will works for most PCI IDE cards.</p>
<p>IRQ3/ 4/ 5/ 7/ 9/ 10/ 11</p>	<p>Available, Reserved</p>	<p>Use the IRQ# address to specify what IRQs can be assigned to a particular peripheral device.</p>

3.6.4 Boot settings

Use the Boot menu to configure system boot options.

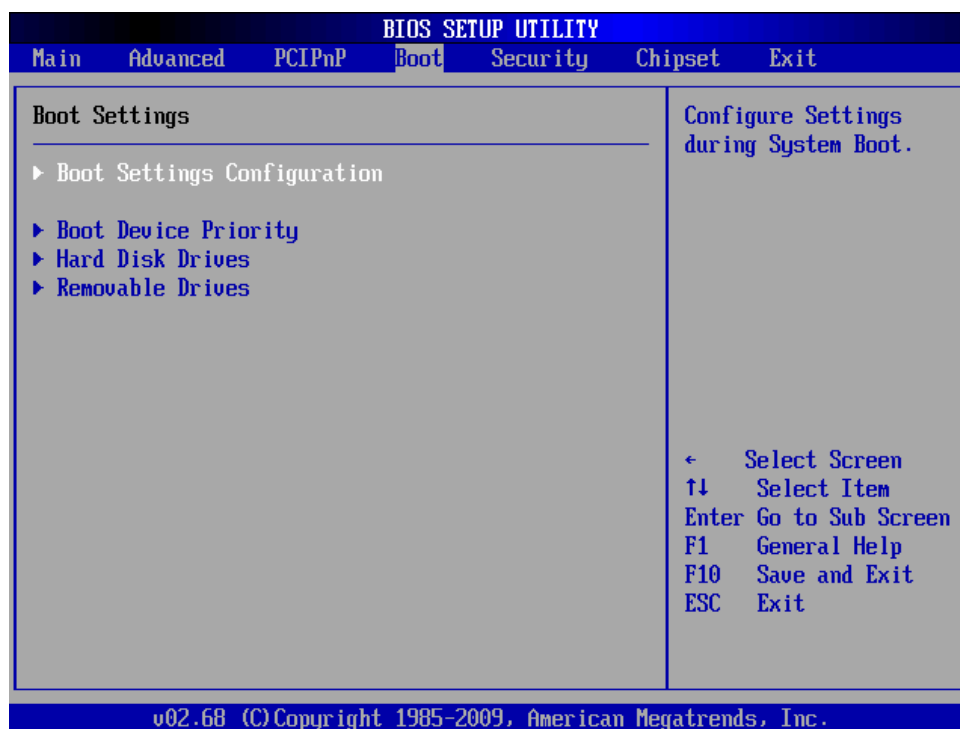

3.6.4.1 Boot settings configuration

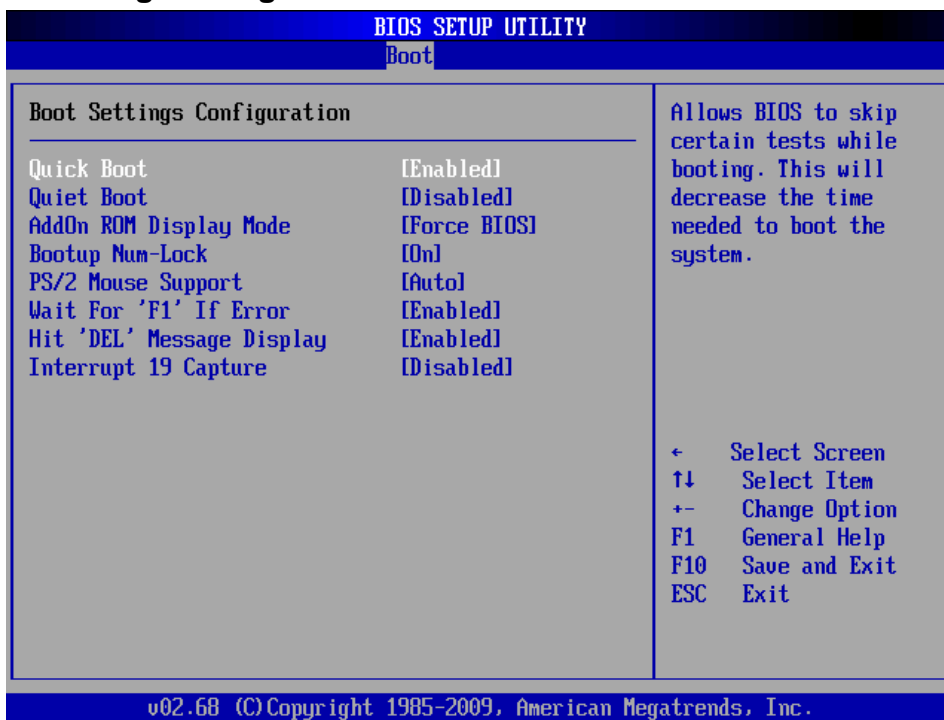

Item	Options	Description
Quick Boot	Disabled, Enabled	This item allows BIOS to skip certain tests while booting. This will decrease the time needed to boot the system.
Quiet Boot	Disabled, Enabled	If set to Disabled, the BIOS displays normal POST messages. If Enabled, an OEM Logo is shown instead of POST messages.
AddOn ROM Display Mode	Force BIOS, Keep Current	This option allows add-on ROM (read-only memory) messages to be displayed.
Bootup Num-Lock	On, Off	This option allows the number Lock setting to be modified during boot up.
PS/2 Mouse support	Auto Disabled, Enabled	This interface utilizes a bidirectional serial protocol to communicate with the computer's auxiliary device controller
Wait For "F1" If Error	Disabled, Enabled	When set to enable, the system waits for the F1 key to be pressed when error occurs.
Hit "DEL" Message Display	Disabled, Enabled	This BIOS feature allows you to control the display of the Hit "DEL" to enter setup message during memory initialization.
Interrupt 19 capture	Disabled, Enabled	This item allows options for ROMs to trap interrupt 19.

3.6.4.2 Boot device Priority

Use the Boot Device Priority menu to specify the boot sequence from the available devices.

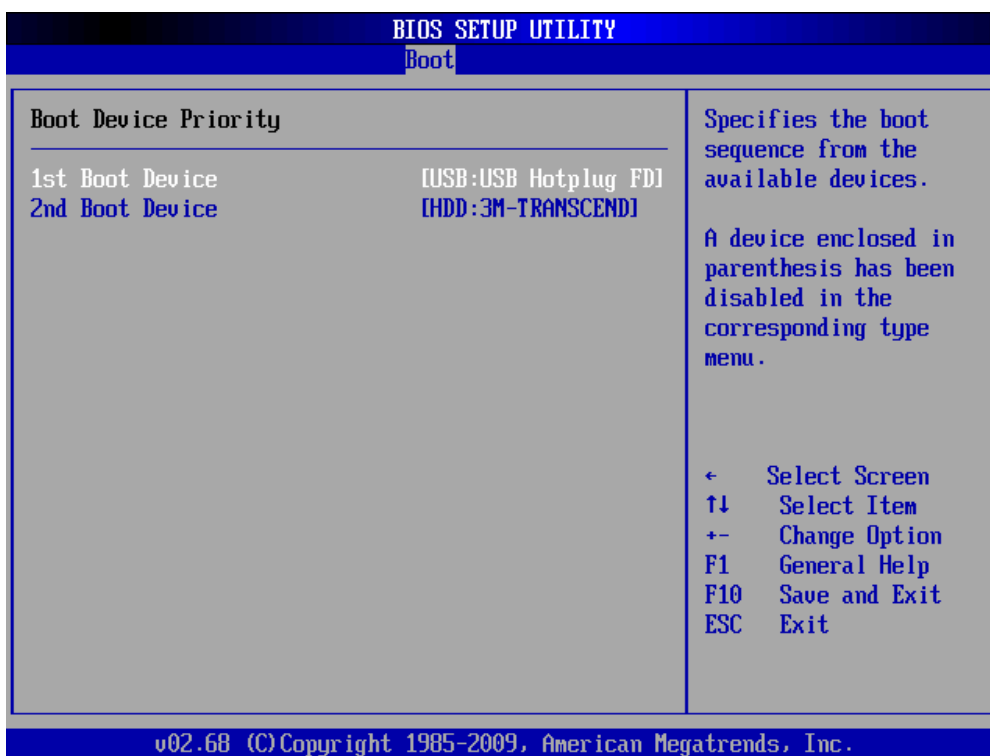

3.6.4.3 Removable Drives

Specifies boot sequence from the available devices

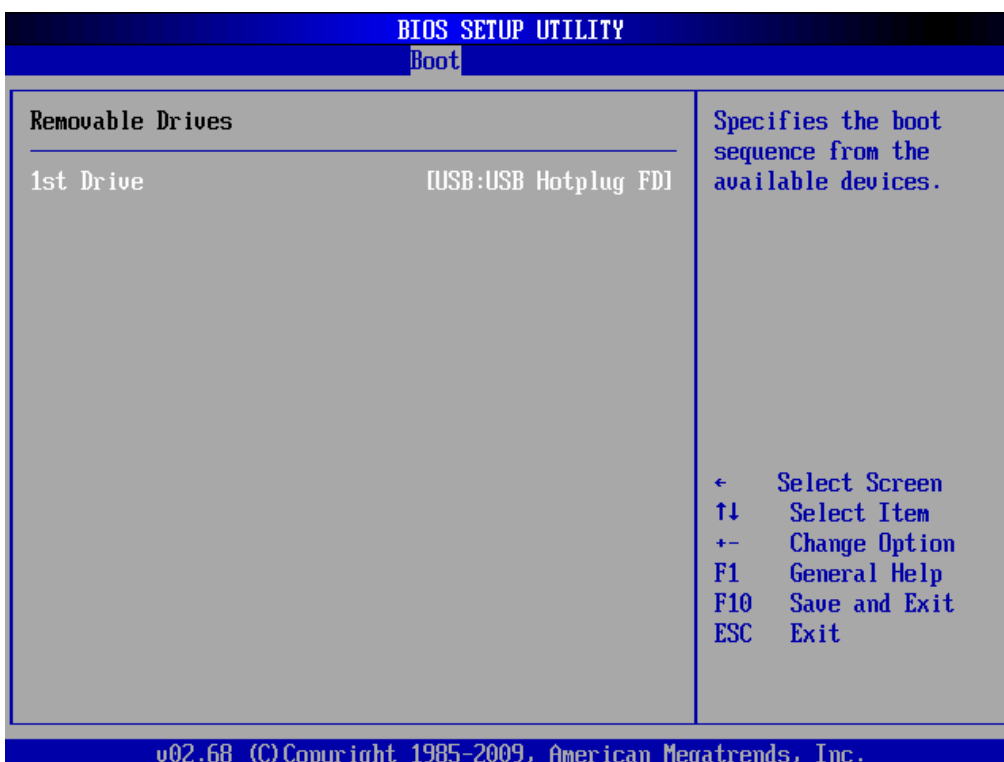

3.6.4.4 Hard Disk Drives

Use the Hard Disk Drives menu to specify the boot sequence of the available devices.

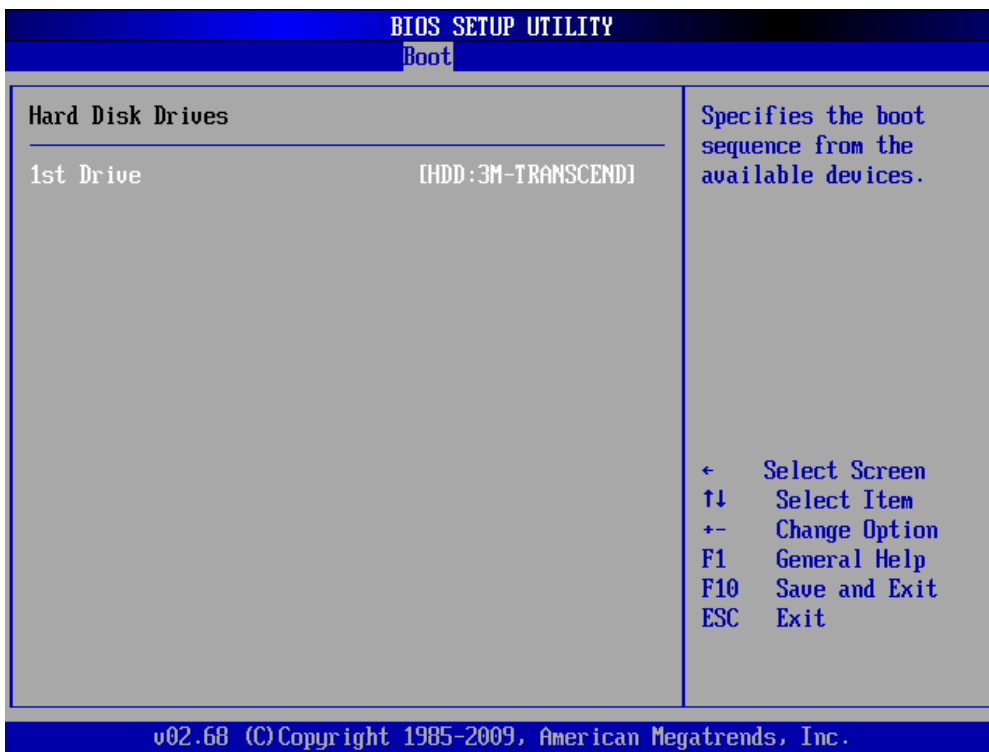

3.6.5 Security settings

Security Setup options, such as password protection and virus protection are described in this section.

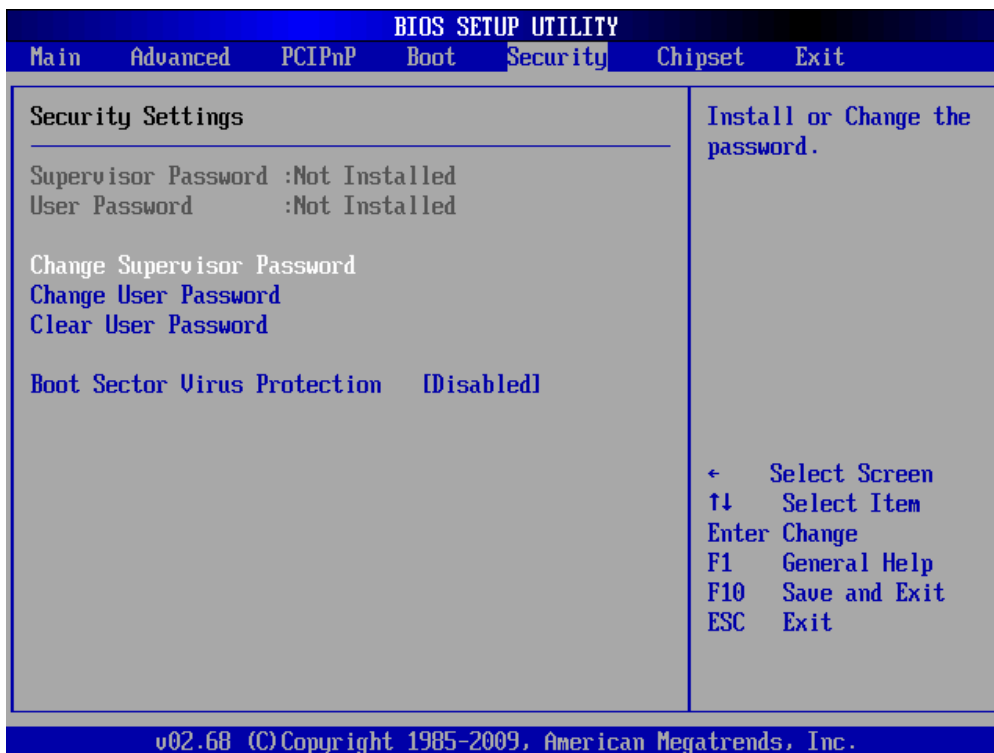

Change Supervisor / User Password

This item is for either installing or changing the password.

Clear User password

Use Clear User Password to delete a user password.

Item	Options	Description
Boot Sector Virus protection	Disabled, Enabled	The boot sector virus protection will warn if any program tries to write to the boot sector.

3.6.6 Advanced Chipset Settings



3.6.6.1 North bridge Chipset configuration

Use the Northbridge chipset configuration menu to configure the Northbridge chipset.

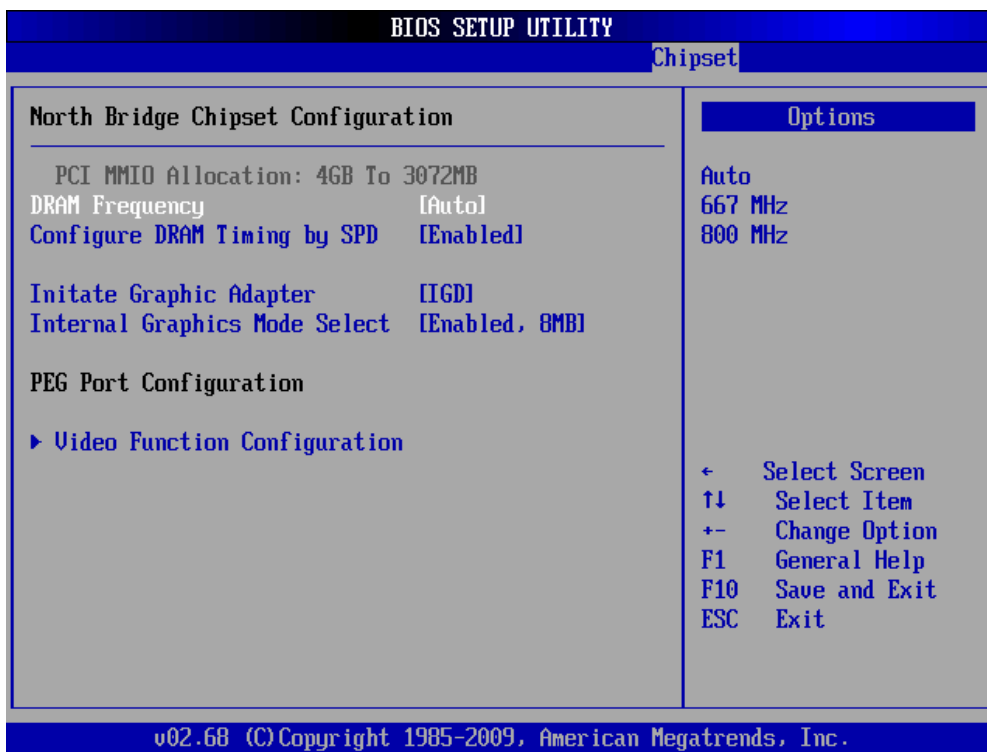

Item	Option	Description
DRAM Frequency	Auto, Max MHz	This item allows you to manually change DRAM frequency.
Configure DRAM Timing by SPD	Disabled, Enabled	This item allows you to enable or disable by DRAM SPD.
Initiate Graphic Adapter	IGD, PCI/IGD, PCI/PEG, PEG/IGD, PEG/PCI	This item allows you to select which graphics controller to use as the primary boot device.
Internal Graphics Mode Select	Enabled 8MB	This option determines the amount of system memory that can be used by the internal graphics device.

3.6.6.2 Video Function configuration

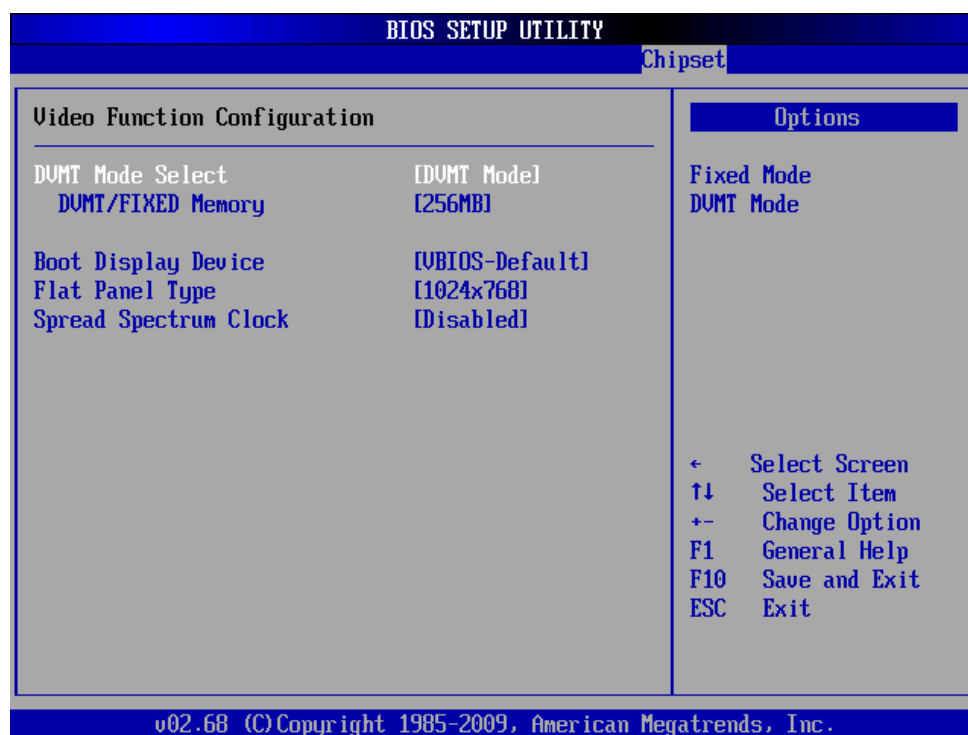

Item	Option	Description
DVMT Mode Select	Fixed Mode, DVMT Mode	Displays the active system memory mode.
DVMT/ FIXED Memory	64MB, 128MB, Maximum DVMT	Specifies the amount of DVMT/ FIXED system memory to allocate for video memory.
Boot Display Device	VBIOS-Default, CRT, LVDS, CRT+LVDS	Select boot display device at post stage.

EMX-PNV

<p>Flat Panel Type</p>	<p>640 x 480, 800 x 600, 1024 x 768, 1024 x 600, 1024 x 576, 800 x 480, 1280 x 720, 1280 x 768, 800 x 600, 1024 x 600, 1024 x 768, 1024 x 768, 1024 x 768, 1280 x 800, 1280 x 600, 1366 x 768</p>	<p>This item allows you to select the panel resolution you want.</p>
<p>Spread Spectrum Clock</p>	<p>Disabled, Enabled</p>	<p>This item allows you to enable or disable spread spectrum clock.</p>

3.6.6.3 South bridge Chipset configuration

Use the Southbridge chipset configuration menu to configure the Northbridge chipset.

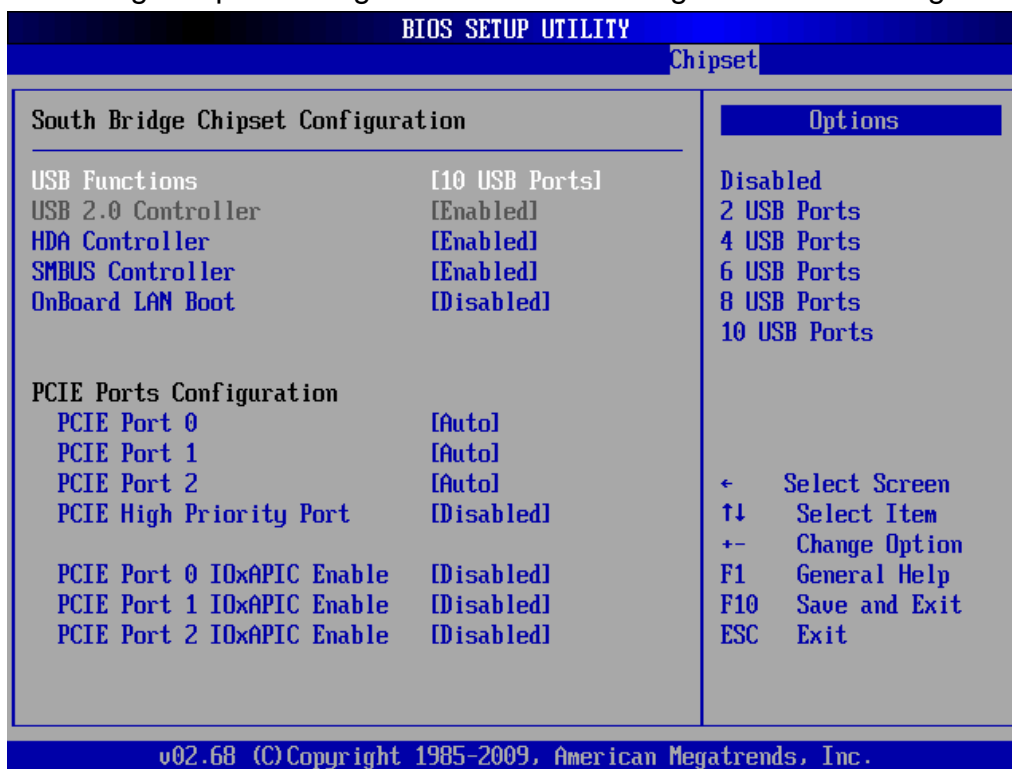

Item	Option	Description
USB Functions	Disables, 2/ 4/ 6/ 8/ 10 USB Ports	This option enables the number of USB ports desired or disables the USB function.
USB 2.0 Controller	Disabled, Enabled	This option is disabled by default.
HAD Controller	Disabled, Enabled	This option is used to enable the southbridge high definition audio controller.
SMBUS Controller	Disabled, Enabled	This option is enabled by default.
OnBoard LAN Boot	Disabled, Enabled	This item helps to set onboard LAN boot mode.
PCIE Port 0/ 1/ 2	Disabled, Enabled, Auto	This section allows selecting PCIE port 0/ 1/ 2 mode.
PCIE High Priority Port	Disabled, Enabled, Auto	This item helps to set PCIE high priority port.
PCIE Port 0/ 1/ 2 IOxAPIC Enable	Disabled, Enabled	This helps to enabled or disabled PCIE port 0/ 1/ 2 IOxAPIC.

3.6.7 Exit Options

Use the Exit menu to load default BIOS values, optional failsafe values and to save configuration changes.

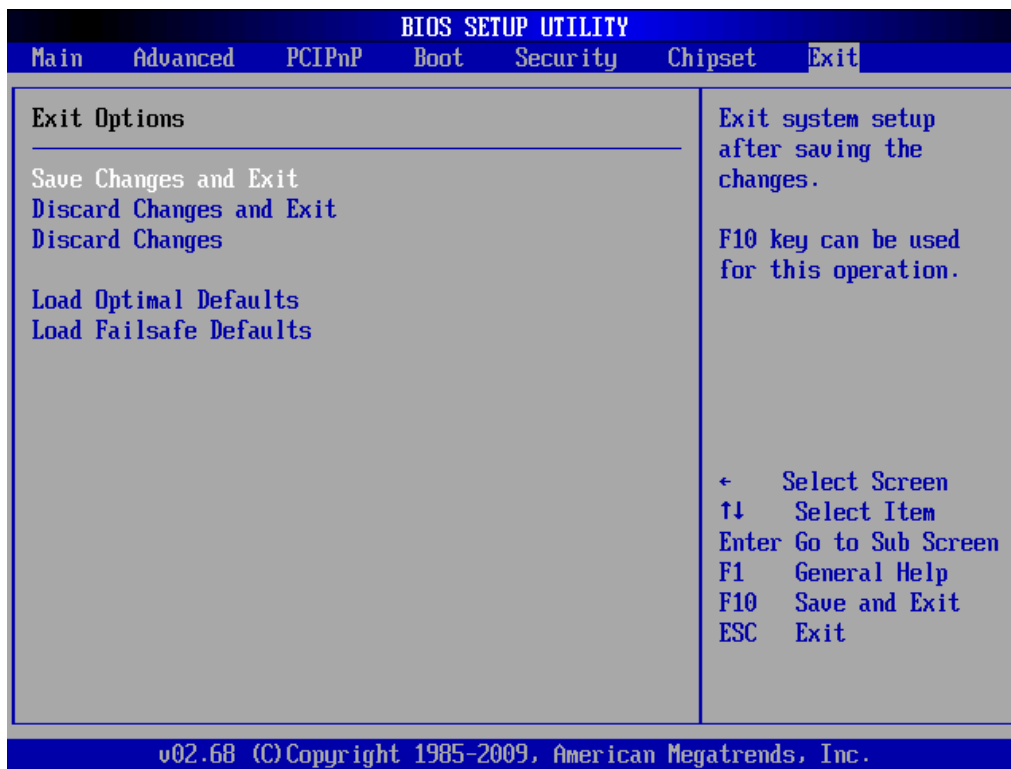

3.6.7.1 Save Changes and Exit

Use the save changes and reset option to save the changes made to the BIOS options and to exit the BIOS configuration setup program.

3.6.7.2 Discard Changes and Exit

Use the Discard changes and Exit option to exit the system without saving the changes made to the BIOS configuration setup program.

3.6.7.3 Discard Changes

Use the Discard Changes option to discard the changes and remain in the BIOS configuration setup program.

3.6.7.4 Load Optimal Defaults

Use the Load Optimal Defaults option to load the optimal default values for each of the parameters on the setup menus. F9 key can be used for this operation.

3.6.7.5 Load Failsafe Defaults

Select this option to replace most of the current BIOS settings with predefined settings (coded into the BIOS) that are intended to put the system into as stable a state as possible

4. Drivers Installation



Note: Installation procedures and screen shots in this section are for your reference and may not be exactly the same as shown on your screen.

4.1 Install Ethernet Driver (For Intel 82583V)

Insert the Supporting DVD-ROM to DVD-ROM drive, and it should show the index page of Avalue's products automatically. If not, locate Index.htm and choose the product from the menu left, or link to **D:\Driver\Mini ITX\EMX-PNV driver\82583V**.



Note: The installation procedures and screen shots in this section are based on Windows XP operation system.

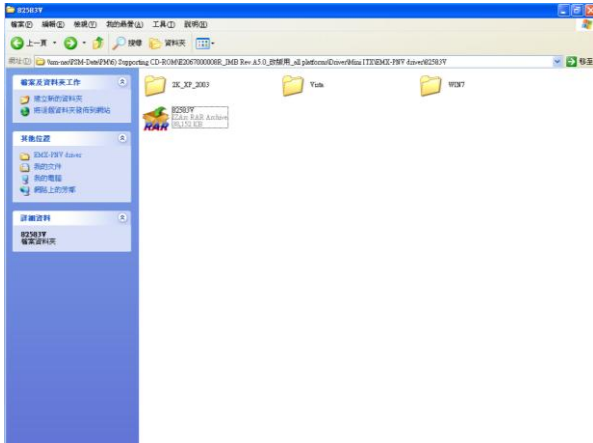

Step 1. Locate 「\Driver_Gigabit\Intel\82574L」 and choose your system OS.

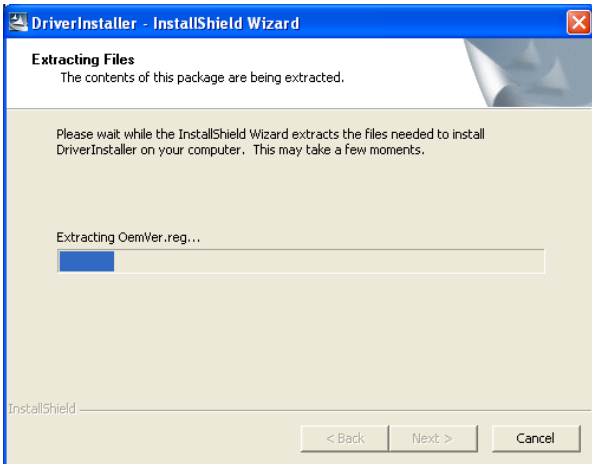

Step 2. Click **Next**.

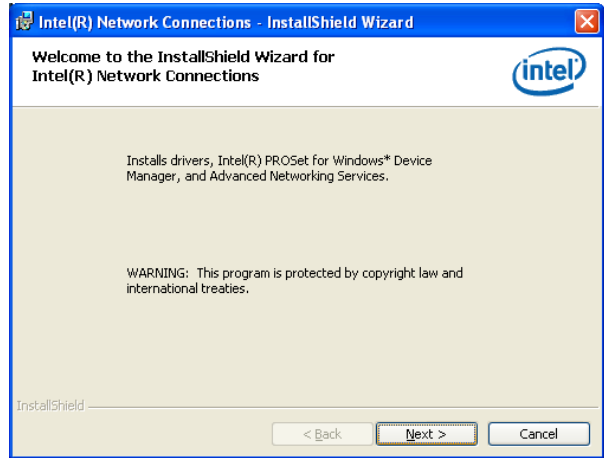

Step 3. Click **Next** to run the installation.

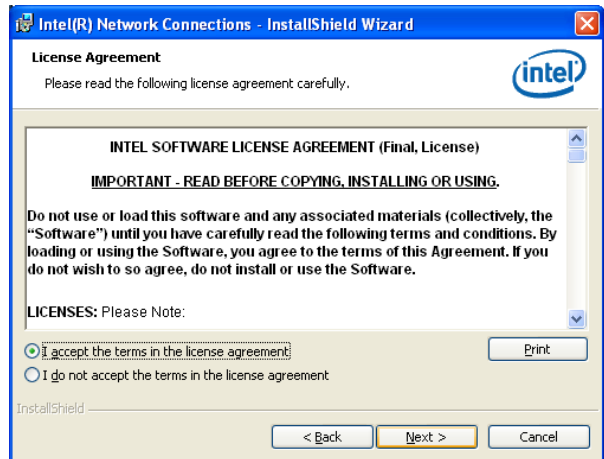

Step 4. Click **Accept** to continue.

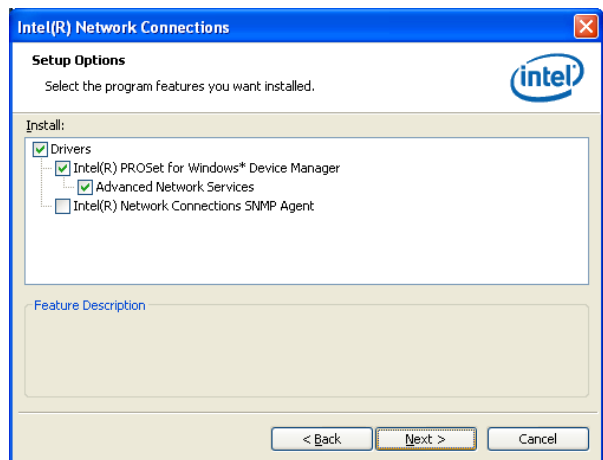

Step 5. Click **Next**.

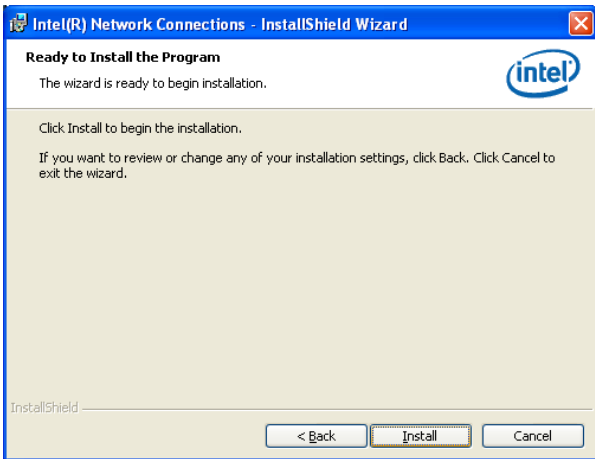

Step 6. Click **Install** to next step.

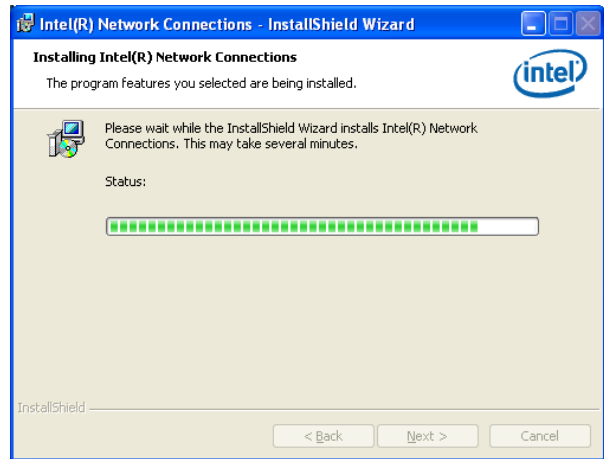

Step 7. Click **Next** to next step.

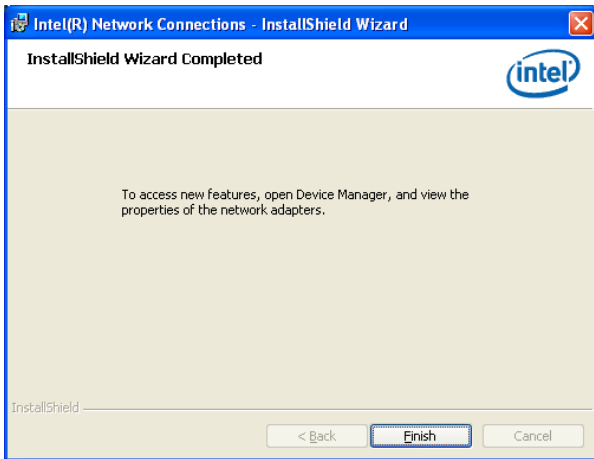

Step 8. Click **Finish** to complete the setup.

5. Mechanical Drawing



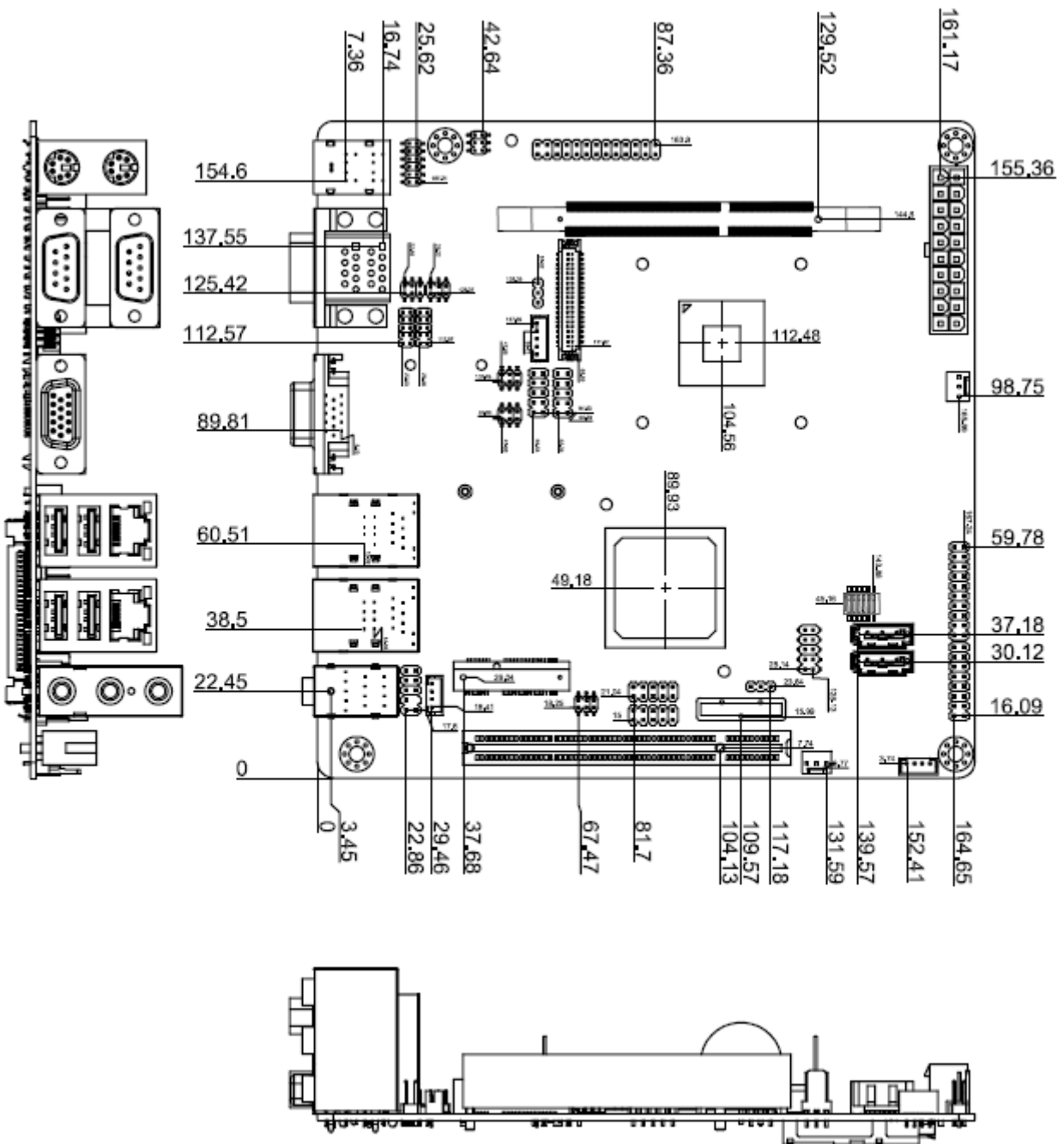

Unit: mm

