

EMX-GM45E

Intel Core 2 Duo GM45 Mini-ITX Board

User's Manual

1st Ed – 22 February 2011

FCC Statement



THIS DEVICE COMPLIES WITH PART 15 FCC RULES. OPERATION IS SUBJECT TO THE FOLLOWING TWO CONDITIONS:

- (1) THIS DEVICE MAY NOT CAUSE HARMFUL INTERFERENCE.
- (2) THIS DEVICE MUST ACCEPT ANY INTERFERENCE RECEIVED INCLUDING INTERFERENCE THAT MAY CAUSE UNDESIRE OPERATION.

THIS EQUIPMENT HAS BEEN TESTED AND FOUND TO COMPLY WITH THE LIMITS FOR A CLASS "A" DIGITAL DEVICE, PURSUANT TO PART 15 OF THE FCC RULES.

THESE LIMITS ARE DESIGNED TO PROVIDE REASONABLE PROTECTION AGAINST HARMFUL INTERFERENCE WHEN THE EQUIPMENT IS OPERATED IN A COMMERCIAL ENVIRONMENT. THIS EQUIPMENT GENERATES, USES, AND CAN RADIATE RADIO FREQUENCY ENERGY AND, IF NOT INSTALLED AND USED IN ACCORDANCE WITH THE INSTRUCTION MANUAL, MAY CAUSE HARMFUL INTERFERENCE TO RADIO COMMUNICATIONS.

OPERATION OF THIS EQUIPMENT IN A RESIDENTIAL AREA IS LIKELY TO CAUSE HARMFUL INTERFERENCE IN WHICH CASE THE USER WILL BE REQUIRED TO CORRECT THE INTERFERENCE AT HIS OWN EXPENSE.

Copyright Notice

Copyright © 2011 Avalue Technology Inc., ALL RIGHTS RESERVED.

No part of this document may be reproduced, copied, translated, or transmitted in any form or by any means, electronic or mechanical, for any purpose, without the prior written permission of the original manufacturer.

Trademark Acknowledgement

Brand and product names are trademarks or registered trademarks of their respective owners.

Disclaimer

Avalue Technology Inc. reserves the right to make changes, without notice, to any product, including circuits and/or software described or contained in this manual in order to improve design and/or performance. Avalue Technology assumes no responsibility or liability for the use of the described product(s), conveys no license or title under any patent, copyright, or masks work rights to these products, and makes no representations or warranties that these products are free from patent, copyright, or mask work right infringement, unless otherwise specified. Applications that are described in this manual are for illustration purposes only. Avalue Technology Inc. makes no representation or warranty that such application will be suitable for the specified use without further testing or modification.

Life Support Policy

Avalue Technology's PRODUCTS ARE NOT FOR USE AS CRITICAL COMPONENTS IN LIFE SUPPORT DEVICES OR SYSTEMS WITHOUT THE PRIOR WRITTEN APPROVAL OF Avalue Technology Inc.

As used herein:

1. Life support devices or systems are devices or systems which, (a) are intended for surgical implant into body, or (b) support or sustain life and whose failure to perform, when properly used in accordance with instructions for use provided in the labeling, can be reasonably expected to result in significant injury to the user.
2. A critical component is any component of a life support device or system whose failure to perform can be reasonably expected to cause the failure of the life support device or system, or to affect its safety or effectiveness.

A Message to the Customer

Avalue Customer Services

Each and every Avalue's product is built to the most exacting specifications to ensure reliable performance in the harsh and demanding conditions typical of industrial environments. Whether your new Avalue device is destined for the laboratory or the factory floor, you can be assured that your product will provide the reliability and ease of operation for which the name Avalue has come to be known.

Your satisfaction is our primary concern. Here is a guide to Avalue's customer services. To ensure you get the full benefit of our services, please follow the instructions below carefully.

Technical Support

We want you to get the maximum performance from your products. So if you run into technical difficulties, we are here to help. For the most frequently asked questions, you can easily find answers in your product documentation. These answers are normally a lot more detailed than the ones we can give over the phone. So please consult the user's manual first.

To receive the latest version of the user's manual; please visit our Web site at:

<http://www.avalue.com.tw/>

If you still cannot find the answer, gather all the information or questions that apply to your problem, and with the product close at hand, call your dealer. Our dealers are well trained and ready to give you the support you need to get the most from your Avalue's products. In

EMX-GM45E

fact, most problems reported are minor and are able to be easily solved over the phone. In addition, free technical support is available from Avalue's engineers every business day. We are always ready to give advice on application requirements or specific information on the installation and operation of any of our products. Please do not hesitate to call or e-mail us.

Headquarters and Branch

Avalue Technology Inc.

7F, 228, Lian-cheng Road, Chung Ho City, Taipei,
Taiwan

Tel: +886-2-8226-2345

Fax: +886-2-8226-2777

Information: sales@avalue.com.tw

Service: service@avalue.com.tw

BCM Advanced Research

BCM Advanced Research an Avalue Company

7 Marconi, Irvine, CA92618

Tel: +1-949-470-1888

Fax: +1-949-470-0971

Information: BCMSales@bcmcom.com

Web: www.bcmcom.com

Avalue China

Avalue Technology Inc.

Room 805, Building 9, No.99 Tianzhou Rd.,
Caohejing Development Area,
Xuhui District, Shanghai

Tel: +86-21-5169-3609

Fax: +86-21-5445-3266

Information: sales.china@avalue.com.cn

Service: service@avalue.com.tw

Avalue USA

Avalue Technology Inc.

9 Timber Lane, Marlboro, NJ 07746-1443

Tel: (732) 414-6500

Fax: (732) 414-6501

Information: sales@avalue-usa.com

Service: support@avalue-usa.com

Avalue Europe

Avalue Europe A/S

Moelledalen 22C, 3140

Aalsgaarde, Denmark

Tel: +45-7025-0310

Fax: +45-4975-5026

Information: sales.europe@avalue.com.tw

Service: service.europe@avalue.com.tw

Avalue Japan

Avalue Technology Inc.

2F keduka-Bldg, 2-27-3 Taito,

Taito-Ku, Tokyo 110-0016 Japan

Tel: +81-3-5807-2321

Fax: +81-3-5807-2322

Information: sales.japan@avalue.com.tw

Service: service@avalue.com.tw

Product Warranty

Avalue warrants to you, the original purchaser, that each of its products will be free from defects in materials and workmanship for two years from the date of purchase.

This warranty does not apply to any products which have been repaired or altered by persons other than repair personnel authorized by Avalue, or which have been subject to misuse, abuse, accident or improper installation. Avalue assumes no liability under the terms of this warranty as a consequence of such events. Because of Avalue's high quality-control standards and rigorous testing, most of our customers never need to use our repair service. If any of Avalue's products is defective, it will be repaired or replaced at no charge during the warranty period. For out-of-warranty repairs, you will be billed according to the cost of replacement materials, service time, and freight. Please consult your dealer for more details. If you think you have a defective product, follow these steps:

1. Collect all the information about the problem encountered. (For example, CPU type and speed, Avalue's products model name, hardware & BIOS revision number, other hardware and software used, etc.) Note anything abnormal and list any on-screen messages you get when the problem occurs.
2. Call your dealer and describe the problem. Please have your manual, product, and any helpful information available.
3. If your product is diagnosed as defective, obtain an RMA (return material authorization) number from your dealer. This allows us to process your good return more quickly.
4. Carefully pack the defective product, a complete Repair and Replacement Order Card and a photocopy proof of purchase date (such as your sales receipt) in a shippable container. A product returned without proof of the purchase date is not eligible for warranty service.
5. Write the RMA number visibly on the outside of the package and ship it prepaid to your dealer.

Contents

1. Getting Started	9
1.1 Safety Precautions	9
1.2 Packing List.....	9
1.3 Document Amendment History	10
1.4 Manual Objectives.....	11
1.5 System Specifications	12
1.6 Architecture Overview – Block Diagram.....	14
2. Hardware Configuration	15
2.1 Product Overview.....	16
2.2 Jumper and Connector List.....	17
2.3 Setting Jumpers & Connectors	19
2.3.1 Front Panel Jumper select (JFTP1)	19
2.3.2 Clear CMOS (JBT1)	19
2.3.2 Serial port 2 power selector – Ring, +5V, +12V (JP7)	20
2.3.2 Serial port 5 power selector – Ring, +5V, +12V (JP8)	20
2.4.3 Serial port 2 mode select in RS-232/422/485 mode (JP9).....	21
2.4.4 Serial port 2 in RS-232/485/422 (JP11)	21
2.4.5 Serial port 1 pin-9 power select – Ring, +5V, +12V (JP10)	22
2.4.6 Serial port 3 power select – Ring, +5V, +12V (JP12)	22
2.4.7 Serial port 4 power select – Ring, +5V, +12V (JP13)	23
2.4.8 LCD inverter connector (CN4).....	23
2.4.9 LVDS Back Light control connector (VR1)	24
2.4.10 USB connector 4&5/ 6&7 (CN5/CN6)	24
2.4.11 Front Audio connector (CN7)	25
2.4.12 Side Audio connector (CN8)	25
2.4.13 Serial port 3/4/5/6 connector (CN11/ CN9/ CN10/ CN21)	26
2.4.14 CD-in connector (CN17)	26
2.4.15 SPI connector (CN20).....	27
2.4.16 Speaker out connector (CN23)	27
2.4.17 General purpose I/O connector (DIO1).....	28
2.4.18 CPU fan/ System fan/ AUX fan connector (FAN1/ FAN2/ FAN3).....	29
2.4.19 LVDS connector (LVDS1)	30
2.4.20 ATX 12V power connector (PWR1)	31
2.4.21 ATX power connector (PWR2).....	31
3. BIOS Setup	32
3.1 Starting Setup	33
3.2 Using Setup	34

3.3	Getting Help	35
3.4	In Case of Problems	35
3.5	Main Menu	36
3.5.1	Standard CMOS Features	37
3.5.1.1	Main Menu Selection	37
3.5.1.2	IDE Adapter Setup	38
3.5.1	Advanced BIOS Features	39
3.5.2.1	CPU Feature	40
3.5.2.1	Hard Disk Boot Priority	41
3.5.2.2	CD-ROM Boot Priority	42
3.5.2.3	Virus Warning	42
3.5.2.4	CPU L1 & L2 & L3 Cache	42
3.5.2.5	Hyper-Threading Technology	43
3.5.2.6	Quick Power On Self Test	43
3.5.2.7	First/Second/Third/Other Boot Device	43
3.5.2.8	Boot Up NumLock Status	43
3.5.2.9	Typematic Rate Setting	43
3.5.2.10	Typematic Rate (Chars/Sec)	43
3.5.2.11	Typematic Delay (Msec)	44
3.5.2.12	Security Option	44
3.5.2.13	APIC Mode	44
3.5.2.14	MPS Version Control For OS	44
3.5.2.15	OS Select for DRAM > 64MB	44
3.5.2.16	Report No FDD For WIN95	45
3.5.2.17	Small Logo (EPA) Show	45
3.5.3	Advanced Chipset Features	46
3.5.3.1	System BIOS Cacheable	47
3.5.3.2	Memory Hole At 15M-16M	47
3.5.3.3	Support FSB and DDR3 667Mh	47
3.5.3.4	PCI Express Root Port Func	47
3.5.3.5	VT-d	48
3.5.3.6	AMT BIOS support	48
3.5.3.7	GbE LAN	48
3.5.3.8	VGA Setting	48
3.5.3.9	VGA Boot Device Setting	49
3.5.4	Integrated Peripherals	50
3.5.4.1	OnChip IDE Device	50
3.5.4.1.1	LEGACY Mode Support	51
3.5.4.2	Onboard Device	52
3.5.4.3	Super IO Device	53

EMX-GM45E

3.5.4.4	Watch Dog Timer.....	54
3.5.4.5	USB Device Setting	54
3.5.5	Power Management Setup.....	55
3.5.5.1	PCI Express PM Function	55
3.5.5.2	ACPI Function	56
3.5.5.3	ACPI Suspend Type.....	56
3.5.5.4	Run VGABIOS if S3 Resume	56
3.5.5.5	Power Management.....	56
3.5.5.6	Video Off Method	56
3.5.5.7	Video Off In Suspend.....	56
3.5.5.8	Suspend Type	56
3.5.5.9	MODEM Use IRQ	56
3.5.5.10	Suspended Mode	56
3.5.5.11	HDD Power Down	57
3.5.5.12	Soft-Off by PWR-BTTN.....	57
3.5.5.13	Power On By Ring	57
3.5.5.14	Resume by Alarm.....	57
3.5.5.15	Date<of Month>/Time<hh:mm:ss> Alarm	57
3.5.5.16	Primary/Secondary IDE 0/1, FDD,COM,LPT PORT, PCI PIRQ[A-D]#	57
3.5.6	PnP / PCI Configuration	58
3.5.6.1	Init Display First	58
3.5.6.2	Reset Configuration Data	58
3.5.6.3	Resources Controlled By.....	59
3.5.6.4	PCI / VGA Palette Snoop.....	59
3.5.6.5	Maximum Payload Size	59
3.5.7	PC Health Status.....	59
3.5.5	Load Fail-Safe Defaults.....	60
3.5.6	Load Optimized Defaults	61
3.5.7	Set Supervisor / User Password	61
3.5.8	Save & Exit Setup	63
3.5.9	Exit Without Save	64
4.	Mechanical Drawing	65

1. Getting Started

1.1 Safety Precautions

Warning!



Always completely disconnect the power cord from your chassis whenever you work with the hardware. Do not make connections while the power is on. Sensitive electronic components can be damaged by sudden power surges. Only experienced electronics personnel should open the PC chassis.

Caution!



Always ground yourself to remove any static charge before touching the CPU card. Modern electronic devices are very sensitive to static electric charges. As a safety precaution, use a grounding wrist strap at all times. Place all electronic components in a static-dissipative surface or static-shielded bag when they are not in the chassis.

1.2 Packing List

Before you begin installing your single board, please make sure that the following materials have been shipped:

Before you begin installing your single board, please make sure that the following parts have been shipped.

- 1 x Intel® GM45E Mini ITX Main board
- 1 x DVD-ROM contains the followings:
 - User's Manual in PDF file
 - Drivers
- 1 x COM cable (2.0mm pitch)
- 2 x SATA & Power cable



If any of the above items is damaged or missing, contact your retailer.

1.3 Document Amendment History

Revision	Date	Comment
22 nd	February. 2011	Initial Release

1.4 Manual Objectives

This manual describes in detail the Avalue Technology EMX-GM45E industry motherboard.

We have tried to include as much information as possible but we have not duplicated information that is provided in the standard IBM Technical References, unless it proved to be necessary to aid in the understanding of this board.

We strongly recommend that you study this manual carefully before attempting to interface with EMX-GM45E series or change the standard configurations. Whilst all the necessary information is available in this manual we would recommend that unless you are confident, you contact your supplier for guidance.

Please be aware that it is possible to create configurations within the CMOS RAM that make booting impossible. If this should happen, clear the CMOS settings, (see the description of the Jumper Settings for details).

If you have any suggestions or find any errors concerning this manual and want to inform us of these, please contact our Customer Service department with the relevant details.

1.5 System Specifications

Model	EMX-GM45
Specification	
CPU	Supports 45nm Intel μ FC-PGA/BGA Socket-P Core 2 Duo CPU (Penryn)
BIOS	Award
System Chipset	Intel GM45 / ICH9-M
I/O Chip	Winbond W83627DHG
System Memory	Two 200-pin SODIMM socket supports up to 4 GB DDR2 SDRAM, supports 667, 800
SSD	One Compact Flash Type I/II Socket
Watchdog Timer	Reset: 1 sec.~255 min. and 1 sec. or 1 min./step
SRAM	Non
I/O	
MIO	1 x PS/2 Keyboard, 1 x PS/2 Mouse
GPIO	16-bit Programmable GPIO (DIP Switch)
USB	8 x USB 2.0
Serial Port	1 x RS-232/482/485, 5 x RS-232
SATA	4 x SATA
Expansion	1 PCIe \times 16 Slot
Display	
Chipset	Intel GM45 Integrated
Display Memory	Intel DVMT 5.0
Resolution	CRT mode: 2048 x 1536
	LCD/Simultaneous mode (4:3):
	Widescreen mode:
Dual Display	CRT + LVDS, CRT
LVDS	Dual-Channel 18/24-bit LVDS
VGA Chip	Non
VGA Ports	Single VGA External Ports
Audio	
Chipset	Intel ICH9-M Integrated
AC97 Codec	Realtek ALC888 supports 7.1CH with 6W Amplifier
Ethernet	
LAN 1	Intel 82574L Gigabit LAN, supports Wake on LAN
LAN 2	Intel 82567LM Gigabit LAN, supports Wake on LAN
Ethernet Interface	10/100/1000Base-Tx Fast Ethernet compatible

Mechanical & Environmental 	
Power Type	ATX
Power requirement	+12V / +5V
ACPI	APMI 1.2, support ACPI
Operating Temperature	0~60°C (32~140°F)
Operating Humidity	0%~90% relative humidity, non-condensing
Size (L x W)	6.7" x 6.7" (170 mm x 170 mm)
Weight	0.44 lbs (0.2 Kg)

1.6 Architecture Overview – Block Diagram

The following block diagram shows the architecture and main components of EMX-GM45E.

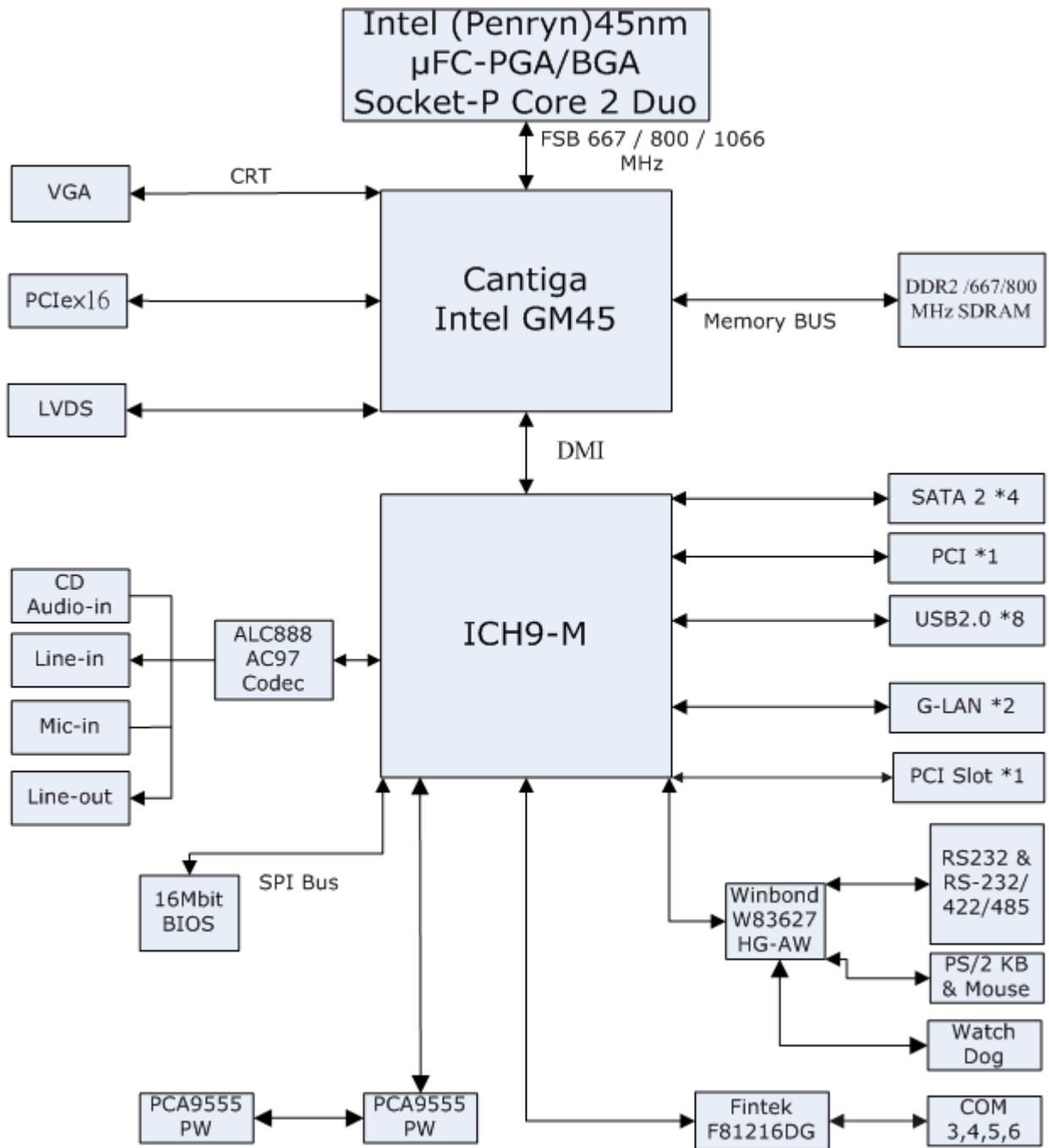

2. Hardware Configuration

2.1 Product Overview

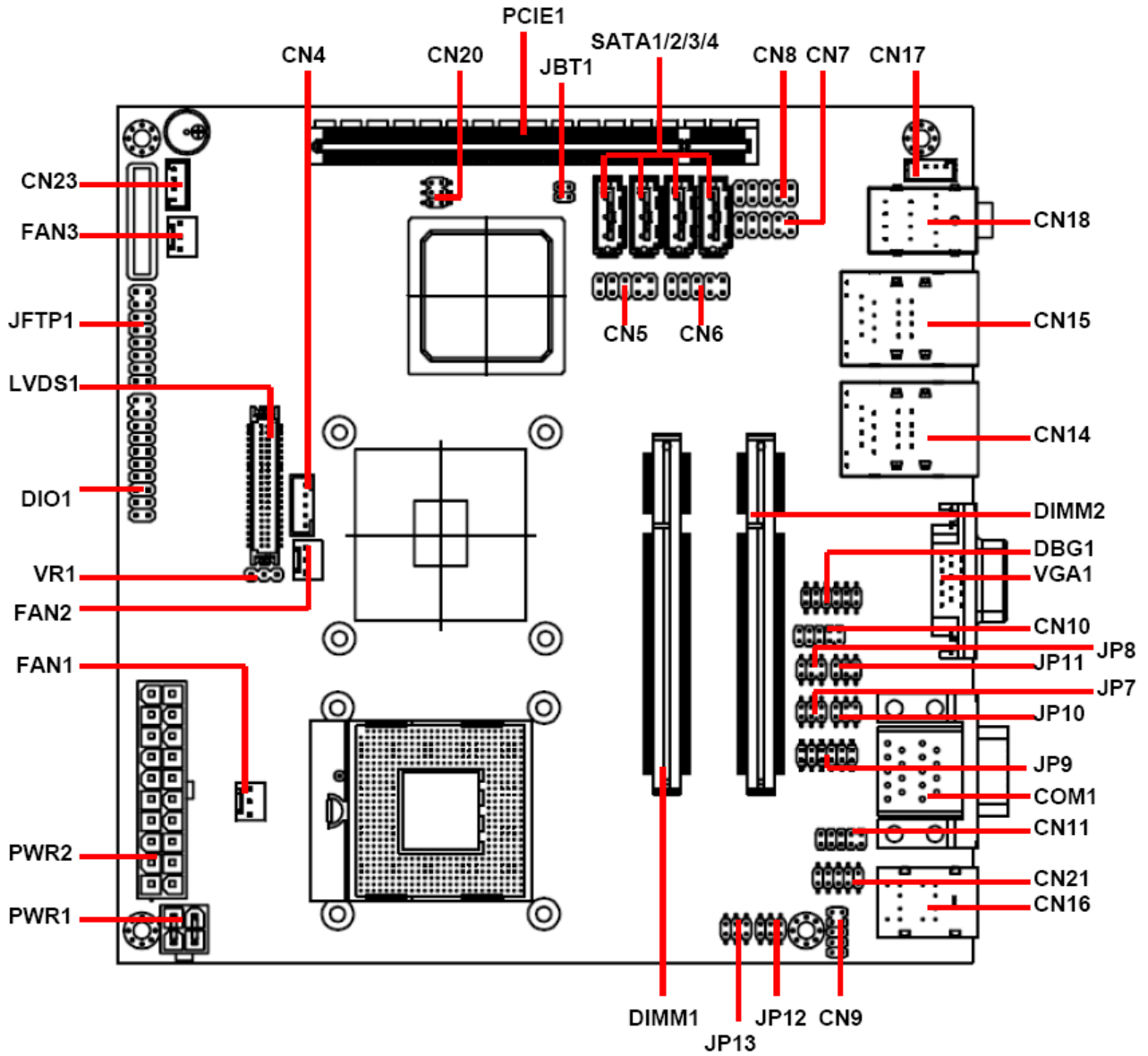

2.2 Jumper and Connector List

You can configure your board to match the needs of your application by setting jumpers. A jumper is the simplest kind of electric switch.

It consists of two metal pins and a small metal clip (often protected by a plastic cover) that slides over the pins to connect them. To “close” a jumper you connect the pins with the clip. To “open” a jumper you remove the clip. Sometimes a jumper will have three pins, labeled 1, 2, and 3. In this case, you would connect either two pins.

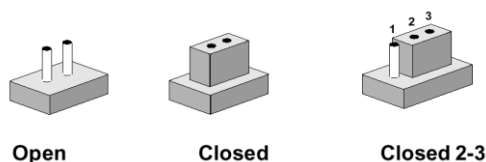

The jumper settings are schematically depicted in this manual as follows:



A pair of needle-nose pliers may be helpful when working with jumpers.

Connectors on the board are linked to external devices such as hard disk drives, a keyboard, or floppy drives. In addition, the board has a number of jumpers that allow you to configure your system to suit your application.

If you have any doubts about the best hardware configuration for your application, contact your local distributor or sales representative before you make any changes.

The following tables list the function of each of the board's jumpers and connectors.

Jumpers

Label	Function	Note
JBT1	Clear CMOS	2 x 2 header, pitch 2.0mm
JFTP1	Front Panel Jumper select	8 x 2 header, pitch 2.54mm
JP7	Serial port 2 power selector – Ring, +5V, +12V	3 x 2 header, pitch 2.0mm
JP8	Serial port 5 power selector – Ring, +5V, +12V	3 x 2 header, pitch 2.0mm
JP9	Serial port 2 mode selector in RS-232/422/485 mode	6 x 2 header, pitch 2.0mm
JP10	Serial port 1 pin-9 power select – Ring, +5V, +12V	3 x 2 header, pitch 2.0mm
JP11	Serial port 2 in RS-232/485/422	3 x 2 header, pitch 2.0mm
JP12	Serial port 3 power select – Ring, +5V, +12V	3 x 2 header, pitch 2.0mm
JP13	Serial port 4 power select – Ring, +5V, +12V	3 x 2 header, pitch 2.0mm

Connectors

Label	Function	Note
CN4	LCD inverter connector	5 x 1 wafer, pitch 2.0mm
CN5	USB connector 4&5	5 x 2 header, pitch 2.54mm
CN6	USB connector 6&7	5 x 2 header, pitch 2.54mm
CN7	Front Audio connector	5 x 2 header, pitch 2.54mm
CN8	Side Audio connector	5 x 2 header, pitch 2.54mm
CN9	Serial port 4 connector	5 x 2 header, pitch 2.0mm
CN10	Serial port 5 connector	5 x 2 header, pitch 2.0mm
CN11	Serial port 3 connector	5 x 2 header, pitch 2.0mm
CN14	USB connector 0 & 1 & RJ45 connector 1	
CN15	USB connector 2 & 3 & RJ45 connector 2	
CN16	PS/2 keyboard & mouse connector	
CN17	CD-in connector	4 x 1 wafer, pitch 2.0mm
CN18	Audio Jack	
CN20	SPI connector	3 x 2 header, pitch 2.0mm
CN21	Serial port 6 connector	5 x 2 header, pitch 2.0mm
CN23	Speaker out connector	4 x 1 wafer, pitch 2.0mm
COM1	Serial port connector	D-sub 9-pin, male
DIMM1	200pin DDR2 SODIMM Socket	
DIMM2	200pin DDR2 SODIMM Socket	
DIO1	General purpose I/O connector	8 x 2 header, pitch 2.54mm
FAN1	CPU fan connector	3 x 1 wafer, pitch 2.54mm
FAN2	System fan connector	3 x 1 wafer, pitch 2.54mm
FAN3	AUX fan connector	3 x 1 wafer, pitch 2.54mm
JBT1	Clear CMOS	2 x 2 header, pitch 2.0mm
LVDS1	LVDS connector	
PCIE1	PCI Express slot	
PWR1	ATX-12V power connector	2 x 2 wafer, pitch 4.2mm
PWR2	ATX power connector	10 x 2 wafer, pitch 4.2mm
SATA1/2/3/4	Serial ATA connector 1/2/3/4	
VGA1	VGA connector 1 & 2	D-sub 15-pin, female
VR1	LVDS Back Light control connector	3 x 1 header, pitch 2.54mm

2.3 Setting Jumpers & Connectors

2.3.1 Front Panel Jumper select (JFTP1)

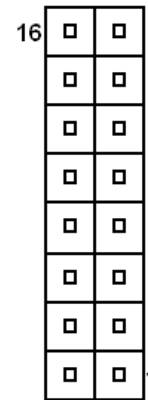
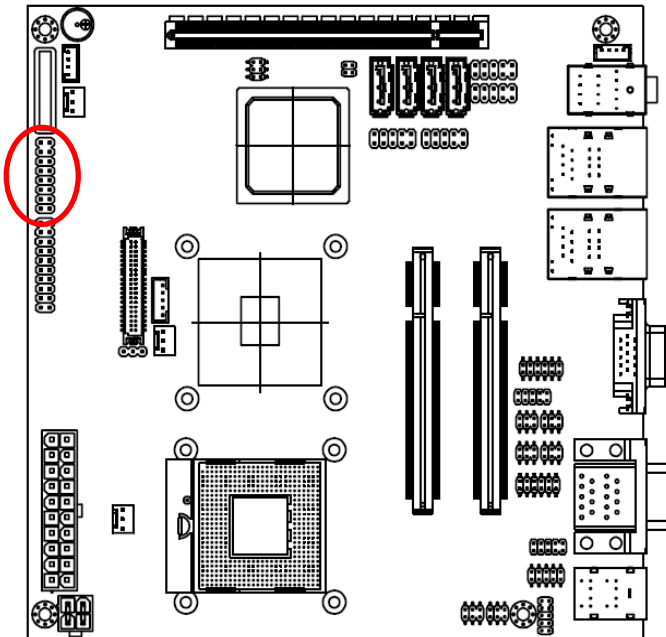

Signal	PIN	PIN	Signal
AUX TIN	1,3	2,4	Stand-by LED
HDD LED	5,7	6,8	BUZZER
RESET	9,11	10,12	PWR LED
PWRBTN	13,15	14,16	OPEN: AT SHORT: ATX

*Default

2.3.2 Clear CMOS (JBT1)

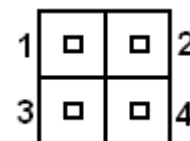
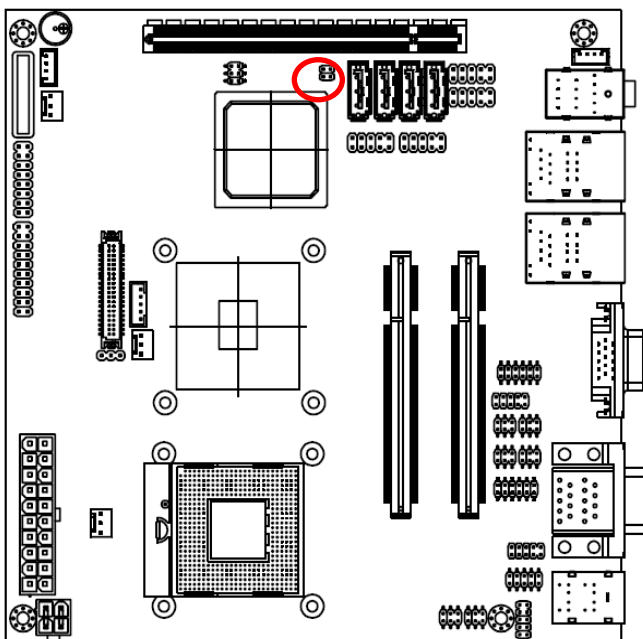

Signal	PIN	PIN	Signal
RTC_RST#	1	2	GND
GND	3	4	SRTC_RST#

EMX-GM45E

2.3.2 Serial port 2 power selector – Ring, +5V, +12V (JP7)

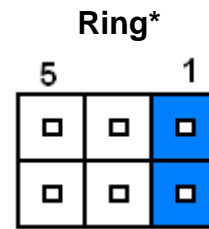
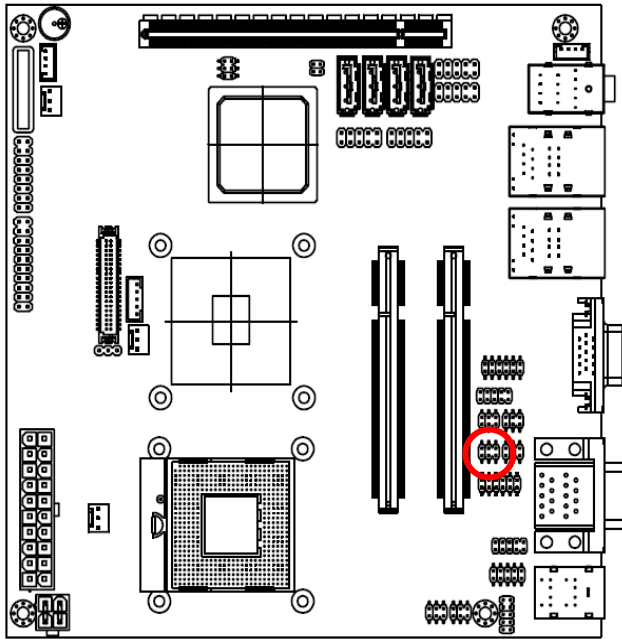

+5V

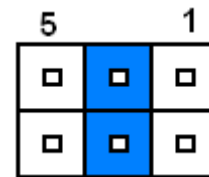

+12V

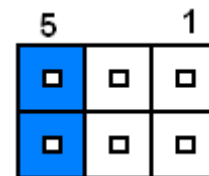

*Default

2.3.2 Serial port 5 power selector – Ring, +5V, +12V (JP8)

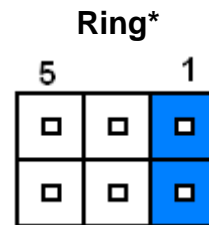
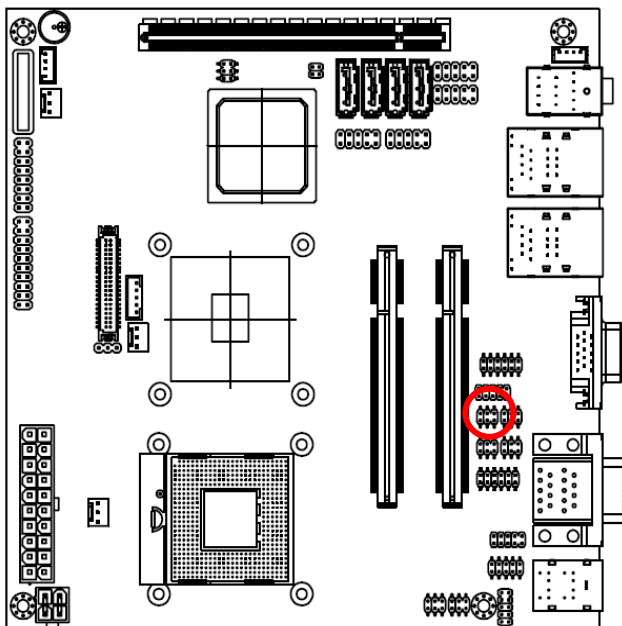

+5V

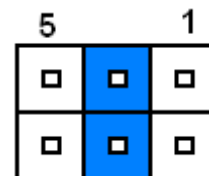

+12V

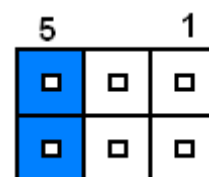

*Default

2.4.3 Serial port 2 mode select in RS-232/422/485 mode (JP9)

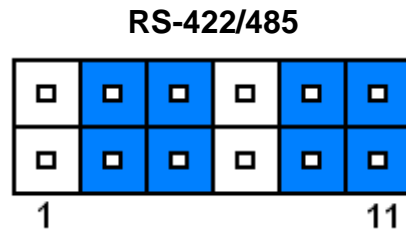
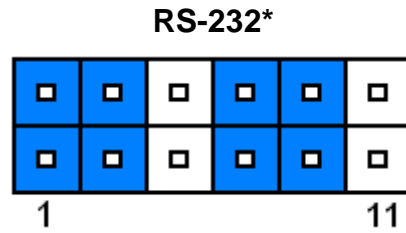
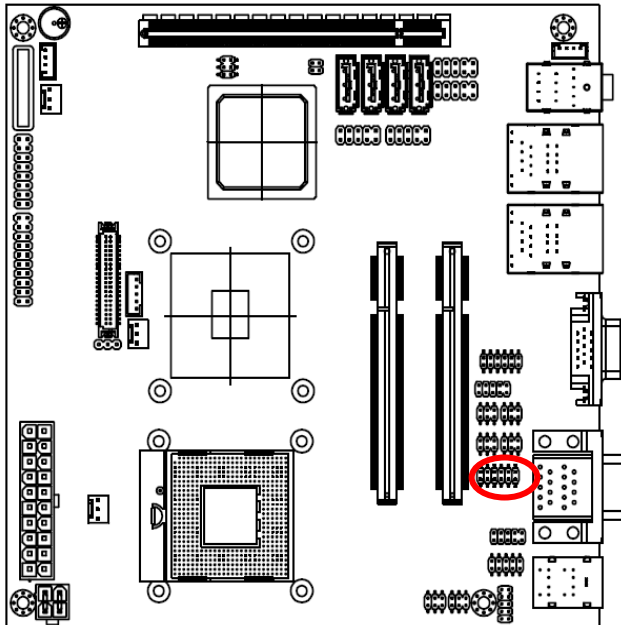

	RS-232	RS-422/485
CM2-1	1-3	3-5
CM2-2	2-4	4-6
CM2-3	7-9	9-11
CM2-4	8-10	10-12

*Default

2.4.4 Serial port 2 in RS-232/485/422 (JP11)

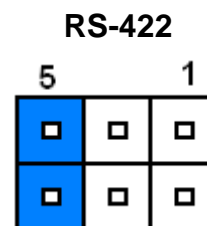
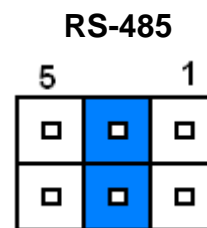
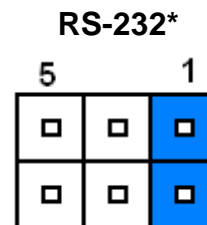
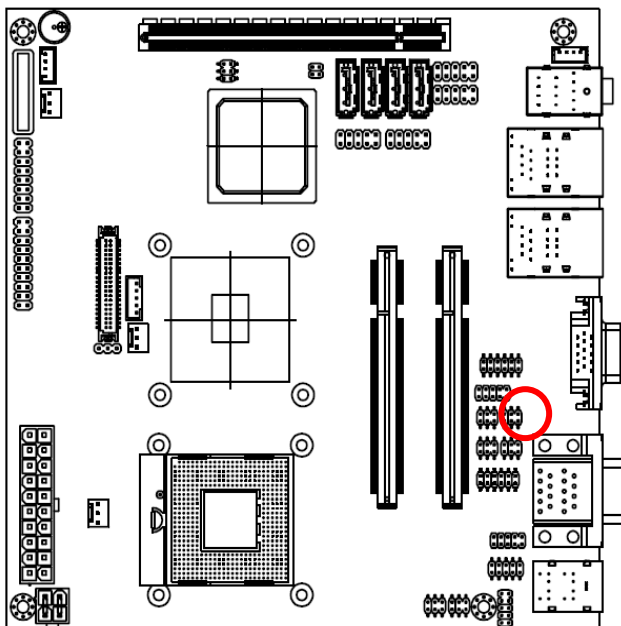

*Default

EMX-GM45E

2.4.5 Serial port 1 pin-9 power select – Ring, +5V, +12V (JP10)

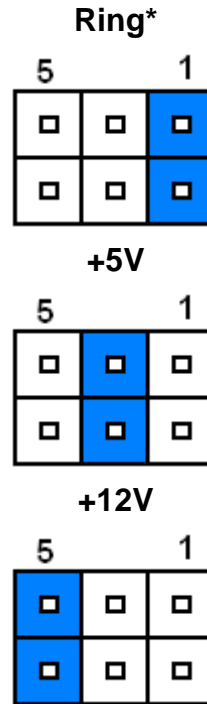
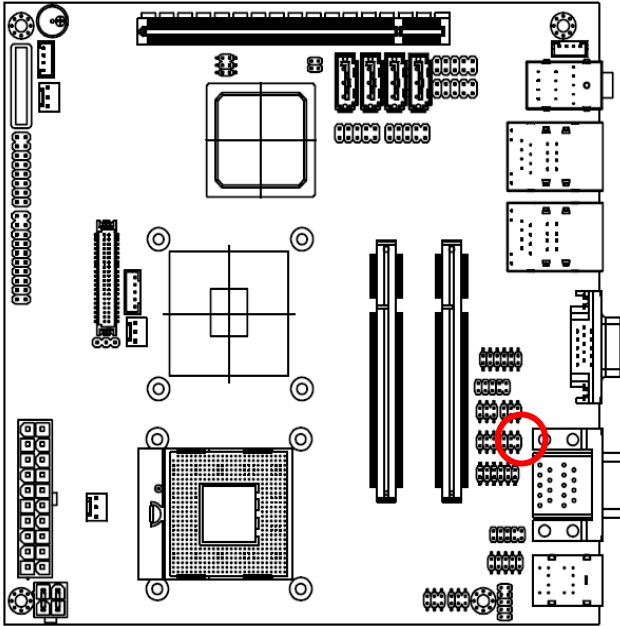

*Default

2.4.6 Serial port 3 power select – Ring, +5V, +12V (JP12)

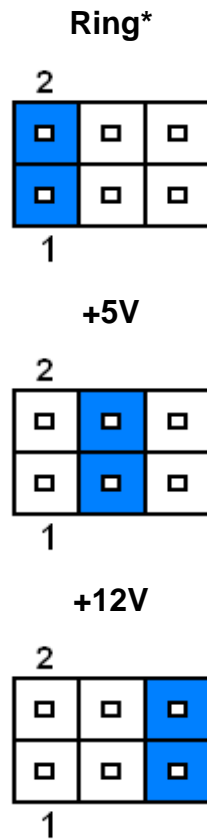
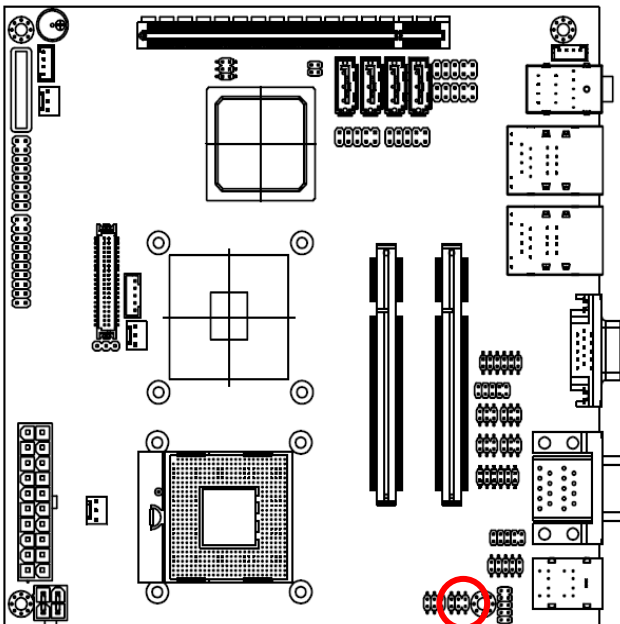

*Default

2.4.7 Serial port 4 power select – Ring, +5V, +12V (JP13)

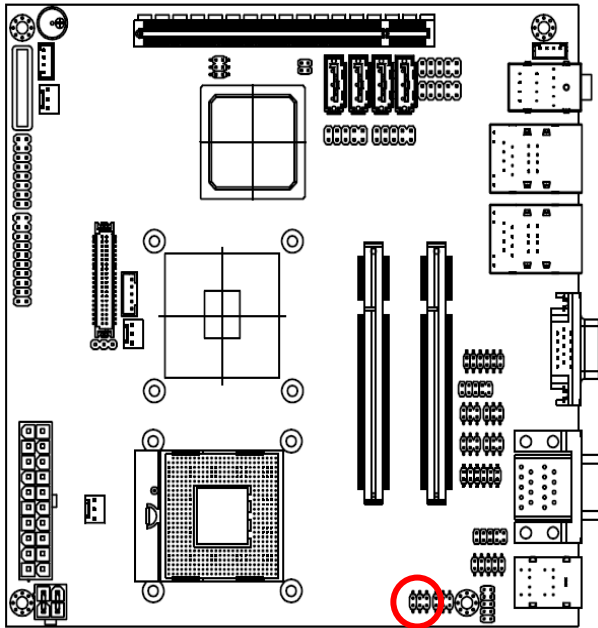

*Default

Ring*

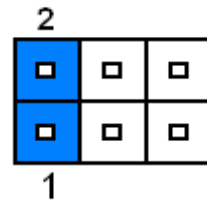

+5V

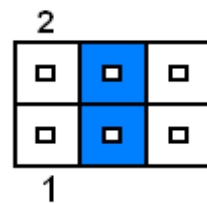

+12V

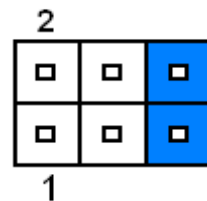

2.4.8 LCD inverter connector (CN4)

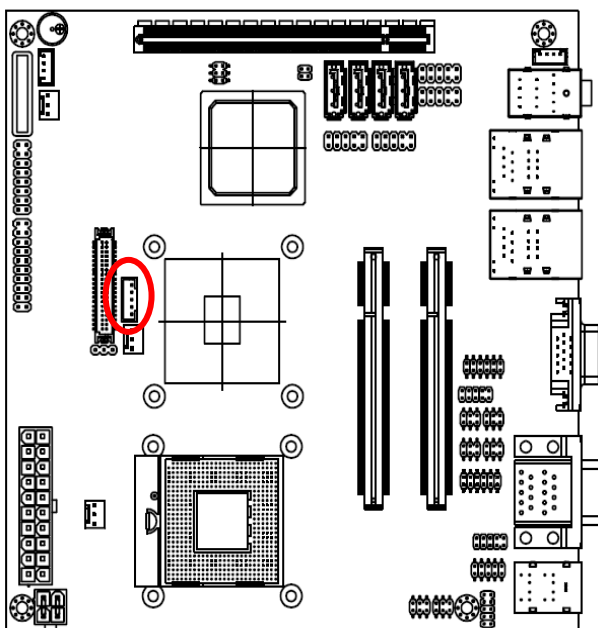

PIN	Signal
1	+12V
2	GND
3	ENBKL
4	VR
5	+5V

EMX-GM45E

2.4.9 LVDS Back Light control connector (VR1)

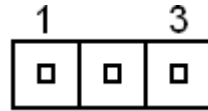
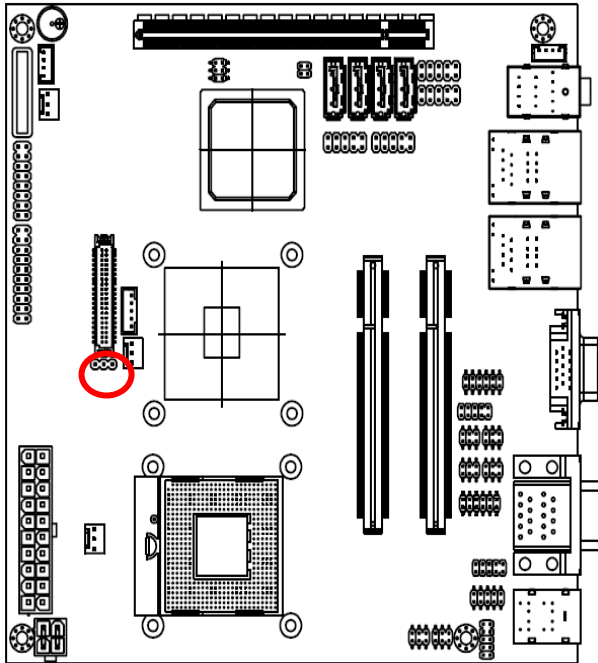

PIN	Signal
1	+5V
2	BRIGHT
3	GND

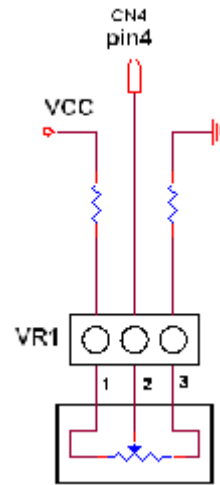

Variation Resistor

(Recommended:

4.7KΩ, >1/16W)

2.4.10 USB connector 4&5/ 6&7 (CN5/CN6)

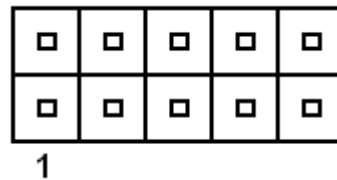
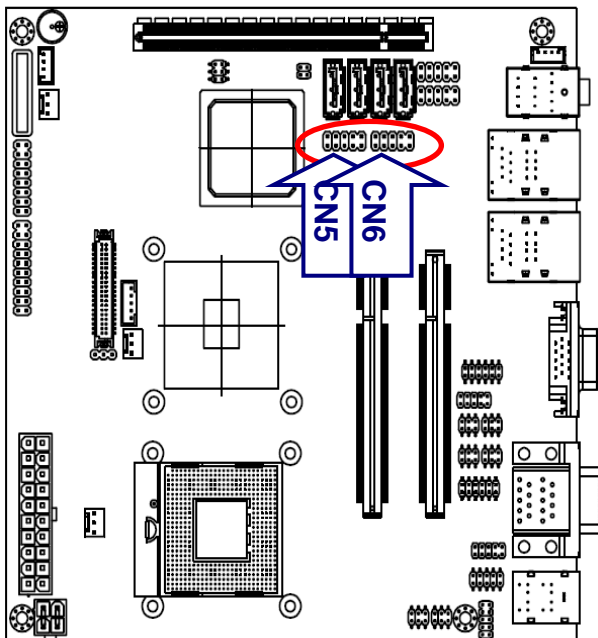

Signal	PIN	PIN	Signal
+5V	1	2	GND
N_P4/6	3	4	GND
P_P4/6	5	6	P_P5/7
GND	7	8	N_P5/7
GND	9	10	+5V

2.4.11 Front Audio connector (CN7)

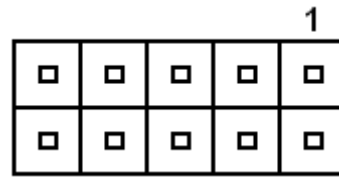
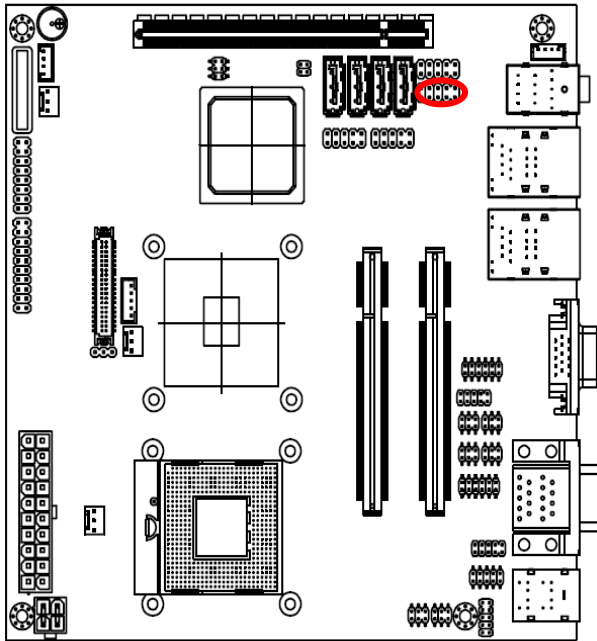

Signal	PIN	PIN	Signal
MIC_L	1	2	GND
MIC_R	3	4	+3.3V
LIN_R	5	6	MIC_JD
FRONT-IO-JD	7	8	NC
LIN_L	9	10	LIN_JD

2.4.12 Side Audio connector (CN8)

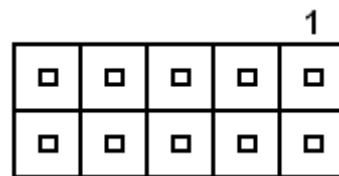
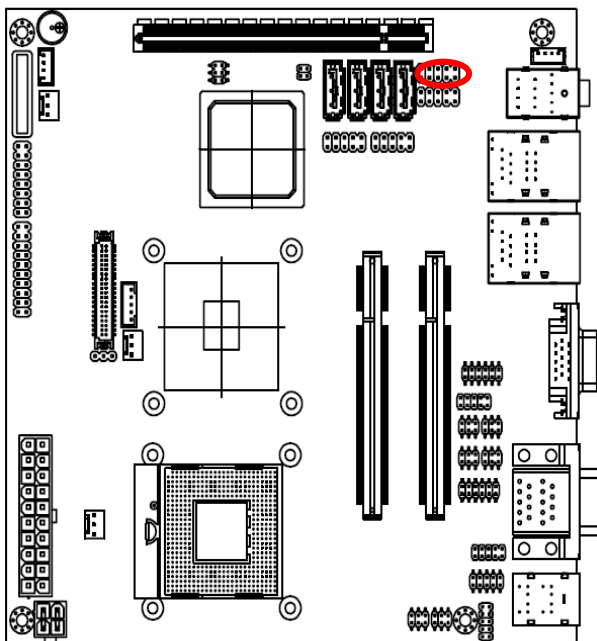

Signal	PIN	PIN	Signal
LFE_OUT	1	2	GND
CEN_OUT	3	4	CEN_JD
SURR_ROUT	5	6	SIDE_R
SURR_JD	7	8	SIDE_JD
SURR_LOUT	9	10	SIDE_L

EMX-GM45E

2.4.13 Serial port 3/4/5/6 connector (CN11/ CN9/ CN10/ CN21)

CN9

CN10/ CN11/ CN21

Signal	PIN	PIN	Signal
DCD	1	2	RxD
TxD	3	4	DTR
GND	5	6	DSR
RTS	7	8	CTS
RI	9	10	NC

2.4.14 CD-in connector (CN17)

Signal	PIN
GND	1
CD_L	2
GND	3
CD_R	4

2.4.15 SPI connector (CN20)

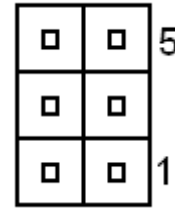
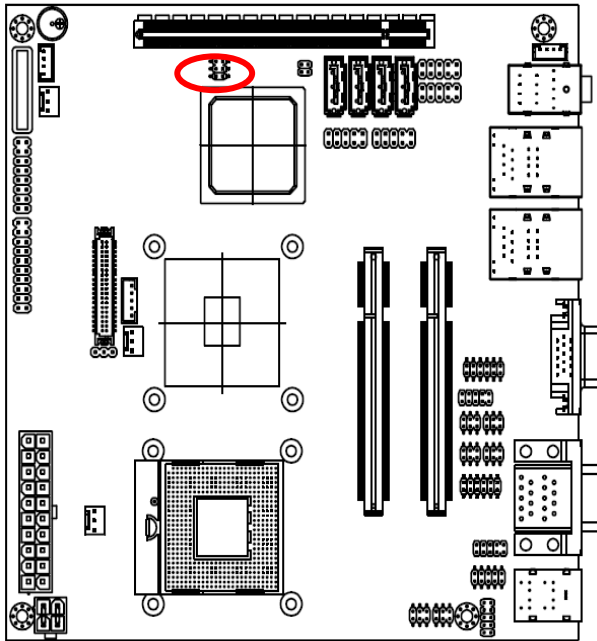

Signal	PIN	PIN	Signal
SPI_SI	6	5	SPI_SO_R
SPI_CLK	4	3	SPI_CS#0
GND	2	1	+3.3V

2.4.16 Speaker out connector (CN23)

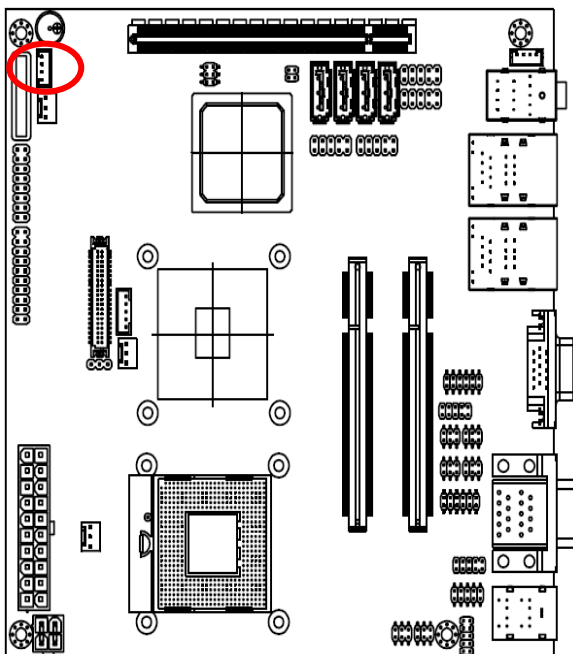

Signal	PIN
AMP_OUT_RP	4
AMP_OUT_RN	3
AMP_OUT_LN	2
AMP_OUT_LP	1

EMX-GM45E

2.4.17 General purpose I/O connector (DIO1)

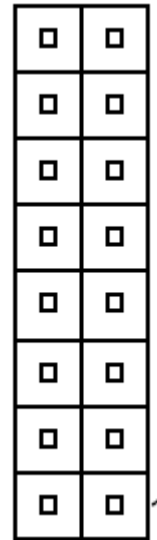
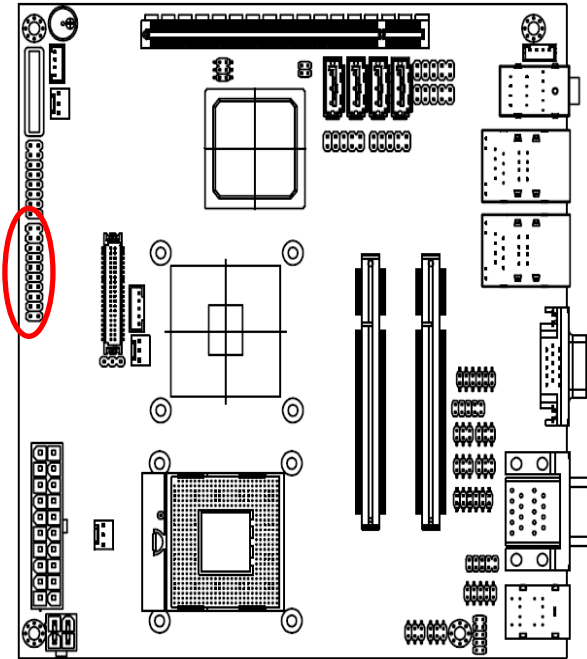

Signal	PIN	PIN	Signal
VCC	20	19	GND
SMB_DATA	18	17	SMB_CLK
DO7	16	15	DI7
DO6	14	13	DI6
DO5	12	11	DI5
DO4	10	9	DI4
DO3	8	7	DI3
DO2	6	5	DI2
DO1	4	3	DI1
DO0	2	1	DI0

2.4.18 CPU fan/ System fan/ AUX fan connector (FAN1/ FAN2/ FAN3)

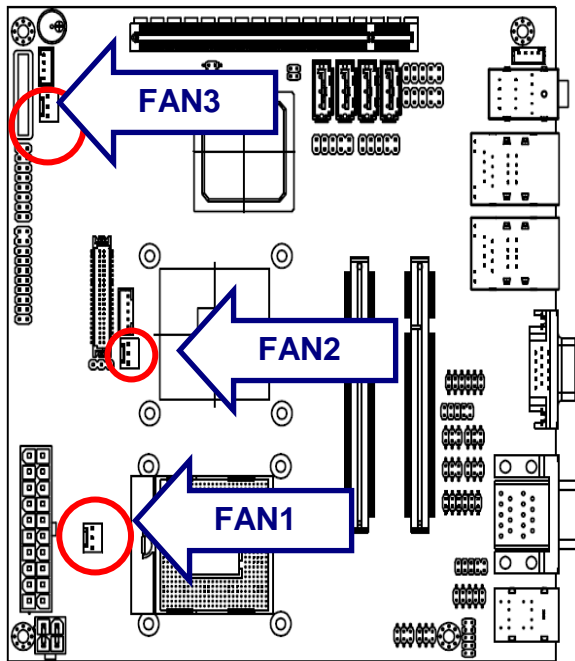

FAN1/ FAN2/ FAN3

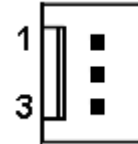

Signal	PIN
GND	1
+12V	2
CPUFANIN/ SYSFANIN/ AUXFANIN	3

EMX-GM45E

2.4.19 LVDS connector (LVDS1)

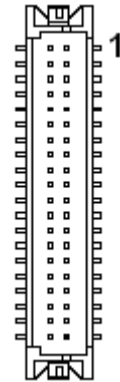
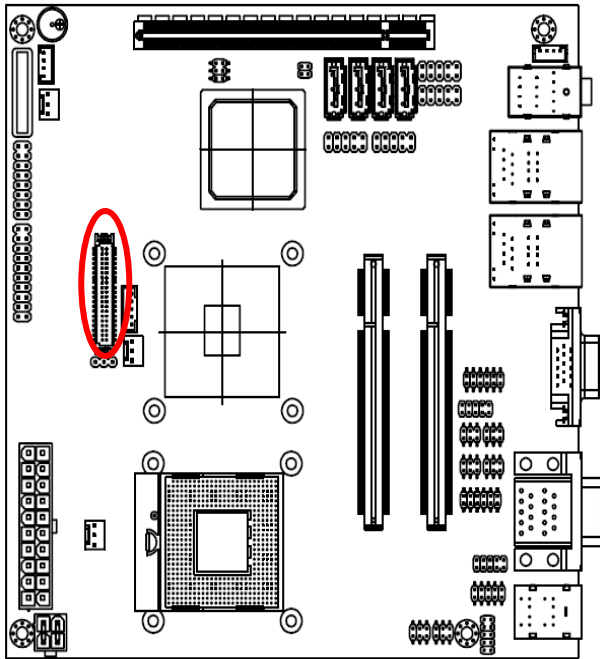

Signal	PIN	PIN	Signal
+5V	2	1	+3.3V
+5V	4	3	+3.3V
SPDATA	6	5	SPCLK
GND	8	7	GND
YA0P	10	9	YA1P
YA0M	12	11	YA1M
GND	14	13	GND
YA2P	16	15	YA3P
YA2M	18	17	YA3M
GND	20	19	GND
YA4P	22	21	YA5P
YA4M	24	23	YA5M
GND	26	25	GND
YA6P	28	27	YA7P
YA6M	30	29	YA7M
GND	32	31	GND
CLK1P	34	33	CLK2P
CLK1M	36	35	CLK2M
GND	38	37	GND
NC	40	39	NC

2.4.20 ATX 12V power connector (PWR1)

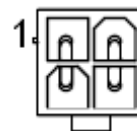
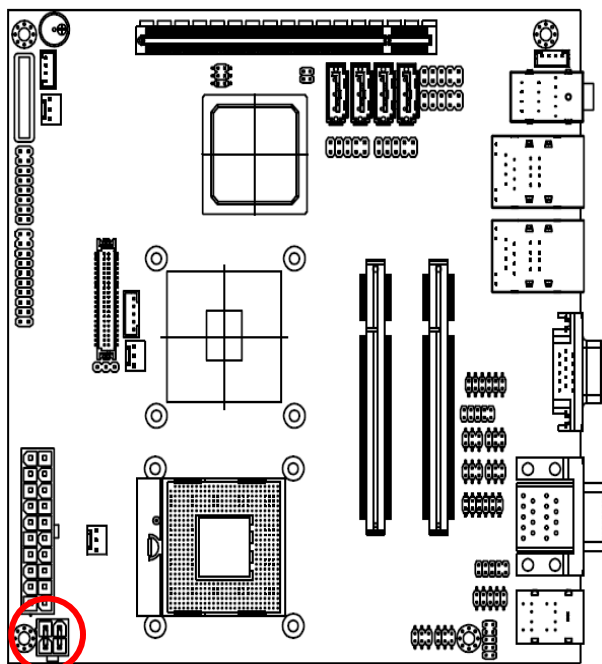

Signal	PIN	PIN	Signal
GND	1	2	GND
+12V	3	4	+12V

2.4.21 ATX power connector (PWR2)

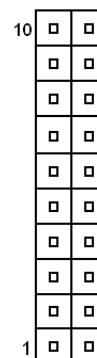
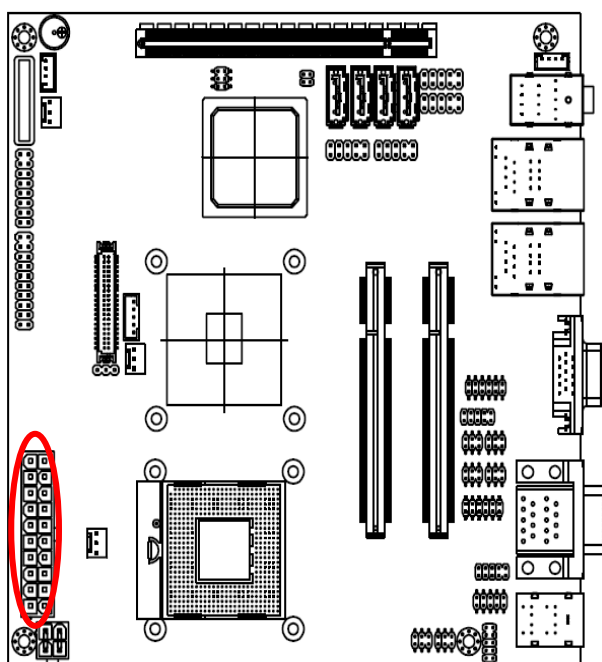

Signal	PIN	PIN	Signal
+12V	10	20	+5V
AUX5V	9	19	+5V
PWROK	8	18	+5V
GND	7	17	GND
+5V	6	16	GND
GND	5	15	GND
+5V	4	14	PSON#
GND	3	13	GND
+3.3V	2	12	-12V
+3.3V	1	11	+3.3V

3. BIOS Setup

3.1 Starting Setup

The AwardBIOS™ is immediately activated when you first power on the computer. The BIOS reads the system information contained in the CMOS and begins the process of checking out the system and configuring it. When it finishes, the BIOS will seek an operating system on one of the disks and then launch and turn control over to the operating system.

While the BIOS is in control, the Setup program can be activated in one of two ways:

By pressing immediately after switching the system on, or

By pressing the key when the following message appears briefly at the bottom of the screen during the POST (Power On Self Test).

Press DEL to enter SETUP

If the message disappears before you respond and you still wish to enter Setup, restart the system to try again by turning it OFF then ON or pressing the "RESET" button on the system case. You may also restart by simultaneously pressing <Ctrl>, <Alt>, and <Delete> keys. If you do not press the keys at the correct time and the system does not boot, an error message will be displayed and you will again be asked to.

Press F1 to Continue, DEL to enter SETUP

3.2 Using Setup

In general, you use the arrow keys to highlight items, press <Enter> to select, use the PageUp and PageDown keys to change entries, press <F1> for help and press <Esc> to quit. The following table provides more detail about how to navigate in the Setup program using the keyboard.

Button	Description
↑	Move to previous item
↓	Move to next item
←	Move to the item in the left hand
→	Move to the item in the right hand
Esc key	Main Menu -- Quit and not save changes into CMOS Status Page Setup Menu and Option Page Setup Menu -- Exit current page and return to Main Menu
PgUp key	Increase the numeric value or make changes
PgDn key	Decrease the numeric value or make changes
+ key	Increase the numeric value or make changes
- key	Decrease the numeric value or make changes
F1 key	General help, only for Status Page Setup Menu and Option Page Setup Menu
(Shift) F2 key	Change color from total 16 colors. F2 to select color forward, (Shift) F2 to select color backward
F3 key	Calendar, only for Status Page Setup Menu
F4 key	Reserved
F5 key	Restore the previous CMOS value from CMOS, only for Option Page Setup Menu
F6 key	Load the default CMOS value from BIOS default table, only for Option Page Setup Menu
F7 key	Load the default
F8 key	Reserved
F9 key	Reserved
F10 key	Save all the CMOS changes, only for Main Menu

- **Navigating Through The Menu Bar**

Use the left and right arrow keys to choose the menu you want to be in.



Note: Some of the navigation keys differ from one screen to another.

- **To Display a Sub Menu**

Use the arrow keys to move the cursor to the sub menu you want. Then press <Enter>. A “>” pointer marks all sub menus.

3.3 Getting Help

Press F1 to pop up a small help window that describes the appropriate keys to use and the possible selections for the highlighted item. To exit the Help Window press <Esc> or the F1 key again.

3.4 In Case of Problems

If, after making and saving system changes with Setup, you discover that your computer no longer is able to boot, the AwardBIOS™ supports an override to the CMOS settings which resets your system to its defaults.

The best advice is to only alter settings which you thoroughly understand. To this end, we strongly recommend that you avoid making any changes to the chipset defaults. These defaults have been carefully chosen by both Award and your systems manufacturer to provide the absolute maximum performance and reliability. Even a seemingly small change to the chipset setup has the potential for causing you to use the override.

3.5 Main Menu

Once you enter the AwardBIOS™ CMOS Setup Utility, the Main Menu will appear on the screen. The Main Menu allows you to select from several setup functions and two exit choices. Use the arrow keys to select among the items and press <Enter> to accept and enter the sub-menu.

Note that a brief description of each highlighted selection appears at the bottom of the screen.

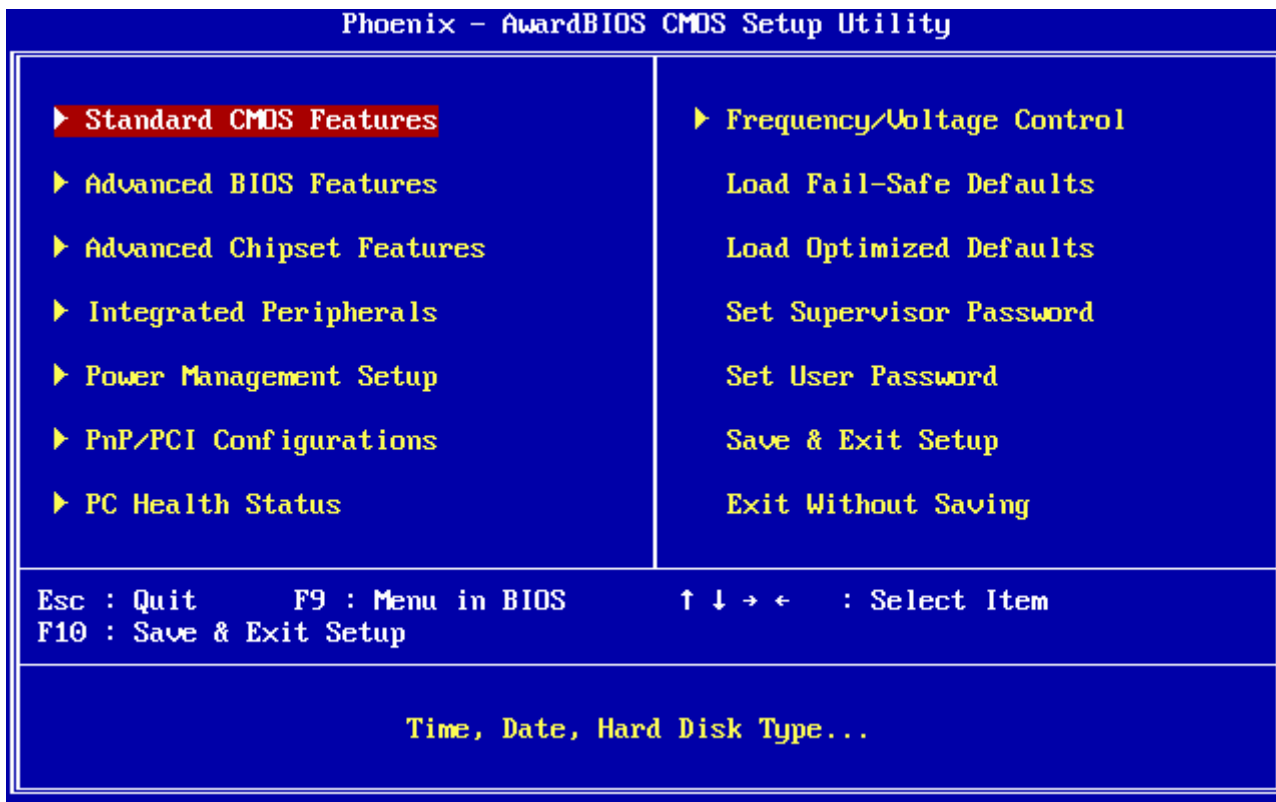

Note: The BIOS setup screens shown in this chapter are for reference purposes only, and may not exactly match what you see on your screen. Visit the Avalue website (www.avalue.com.tw) to download the latest product and BIOS information.

3.5.1 Standard CMOS Features

The items in Standard CMOS Setup Menu are divided into few categories. Each category includes no, one or more than one setup items. Use the arrow keys to highlight the item and then use the <PgUp> or <PgDn> keys to select the value you want in each item.

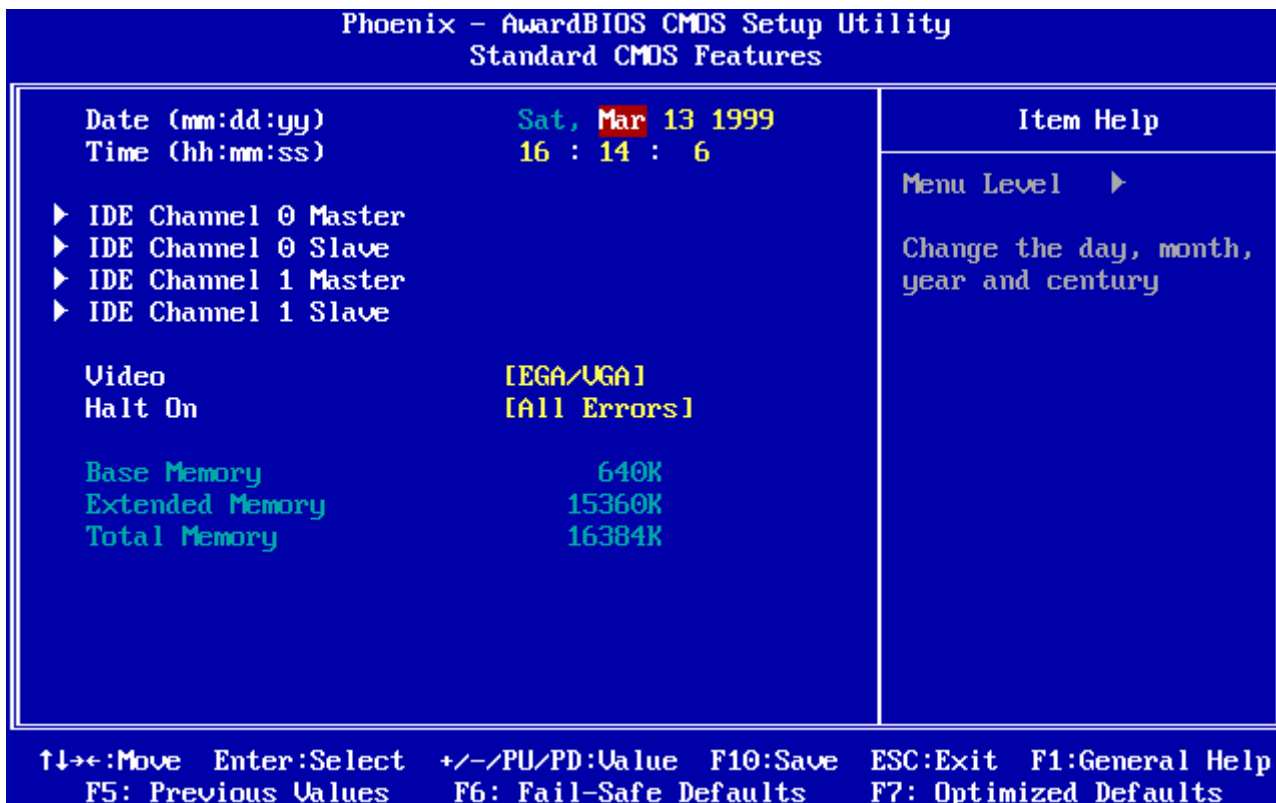

3.5.1.1 Main Menu Selection

This reference table shows the selections that you may make on the Main Menu.

Item	Options	Description
Time	HH : MM : SS	Set the system time
IDE Channel 0 Master IDE Channel 0 Slave IDE Channel 1 Master IDE Channel 1 Slave	Options are in 3.5.1.2	Press <Enter> to enter the sub menu of detailed options
Video	EGA/VGA CGA 40 CGA 80 MONO	Select the default video device
Halt On	All Errors No Errors All, but Keyboard	Select the situation in which you want the BIOS to stop the POST process and notify you

EMX-GM45E

3.5.1.2 IDE Adapter Setup

The IDE adapters control the hard disk drive. Use a separate sub menu to configure each hard disk drive. The below table will shows the IDE primary master sub menu.

Item	Options	Description
IDE HDD Auto-detection	Press Enter	Press Enter to auto-detect the HDD on this channel. If detection is successful, it fills the remaining fields on this menu.
IDE Channel 0 Master IDE Channel 0 Slave IDE Channel 1 Master IDE Channel 1 Slave	None Auto Manual	Selecting 'manual' lets you set the remaining fields on this screen. Selects the type of fixed disk. "User Type" will let you select the number of cylinders, heads, etc. Note: PRECOMP=65535 means NONE !
Access Mode	CHS, LBA Large, Auto	Choose the access mode for this hard disk
The following options are selectable only if the 'IDE Channel ...' item is set to 'Manual'		
Cylinder	Min = 0 Max = 65535	Set the number of cylinders for this hard disk.
Head	Min = 0 Max = 255	Set the number of read/write heads
Precomp	Min = 0 Max = 65535	**** Warning: Setting a value of 65535 means no hard disk
Landing zone	Min = 0 Max = 65535	****
Sector	Min = 0 Max = 255	Number of sectors per track

3.5.1 Advanced BIOS Features

This section allows you to configure your system for basic operation. You have the opportunity to select the system's default speed, boot-up sequence, keyboard operation, shadowing and security.

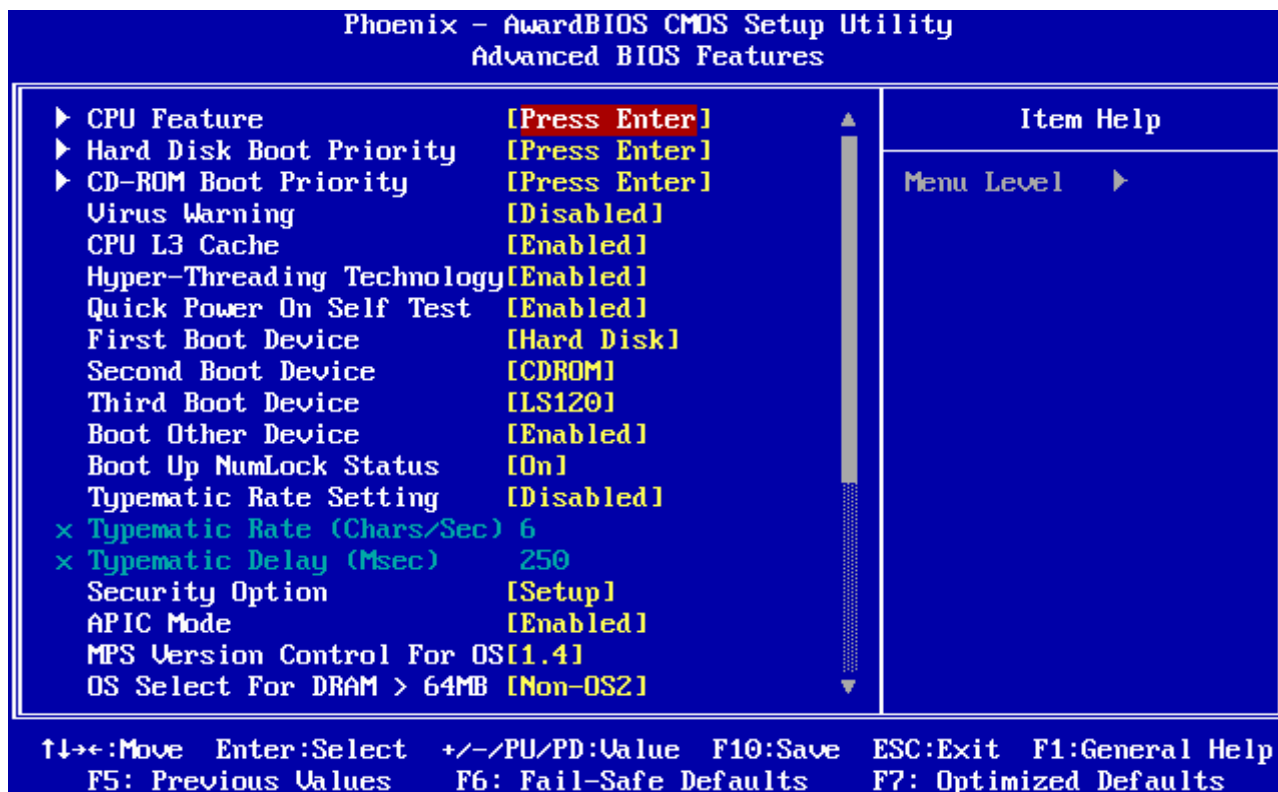

EMX-GM45E

3.5.2.1 CPU Feature

This item allows you to setup the CPU thermal management function.

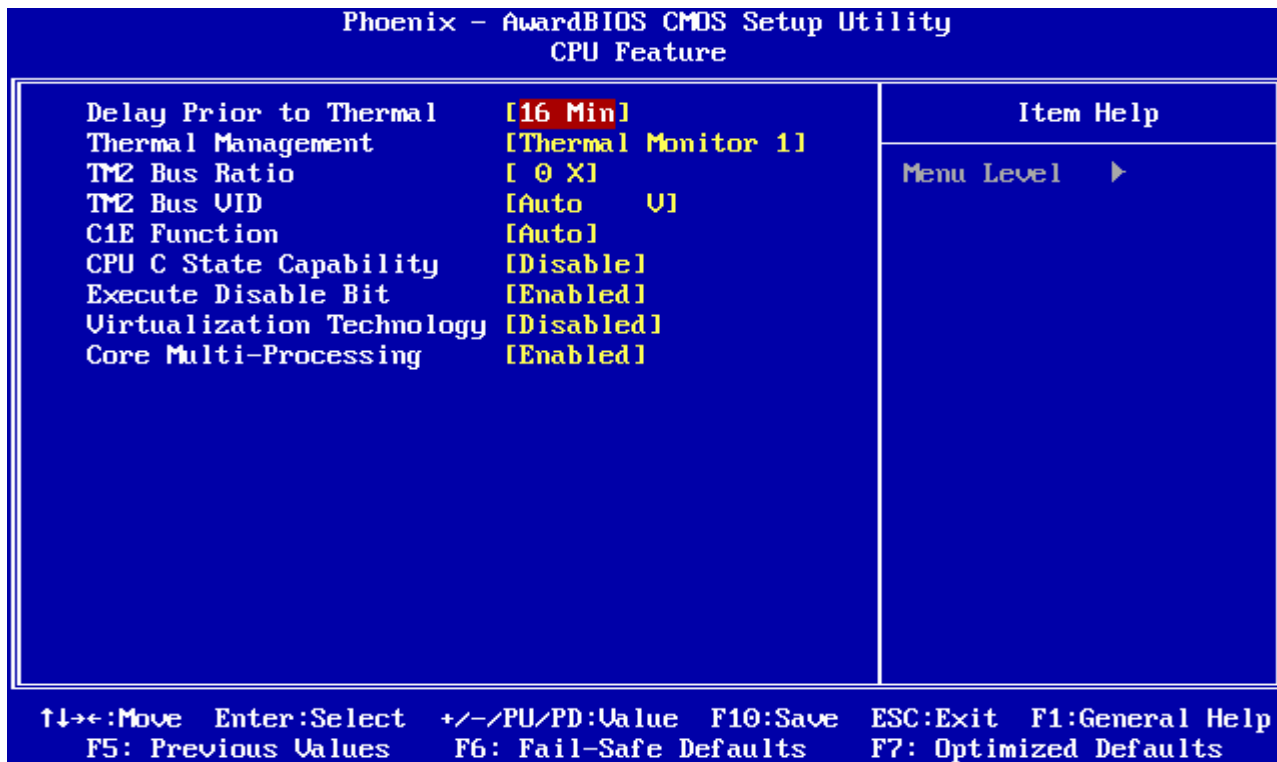

Item	Options	Description
Delay Prior to Thermal	4, 8, 16, 32 Min	Allow the Thermal Monitor to be activated of certain minutes in automatic mode after the system boots.
Thermal Management	Thermal Monitor 1 Thermal Monitor 2	Allow to choose the thermal management method of the monitor.
TM2 Bus Ratio	0~255	Represents the frequency. Bus ratio of the throttled performance state that will be initiated when the on-die sensor goes from not hot to hot.
TM2 Bus VID	0.700 ~ 1.708	Represents the voltage of the throttled performance state that will be initiated when the on-die sensor goes from not hot to hot.
C1E Function	Auto, Disabled	The C1E function enables the Core 2 Extreme to throttle back to its standard clock rate under light load
CPU C State Capability	Disable, C2, C3, C4, Deep C4, C6	This item helps select CPU C State Capability.
Execute Disable Bit	Enabled, Disabled	It can help prevent certain classes of malicious buffer overflow attacks when combined with a supporting operating system.
Virtualization Technology	Enabled, Disabled	This BIOS feature is used to enable or disable the Intel Virtualization Technology (IVT) extensions that allow multiple operating systems to run simultaneously on the same system.
Core Multi-Processing	Enabled, Disabled	This option determine the Core Multi-Processing mode.

3.5.2.1 Hard Disk Boot Priority

This item allows you to set the boot priority from hard drives installed in the system.

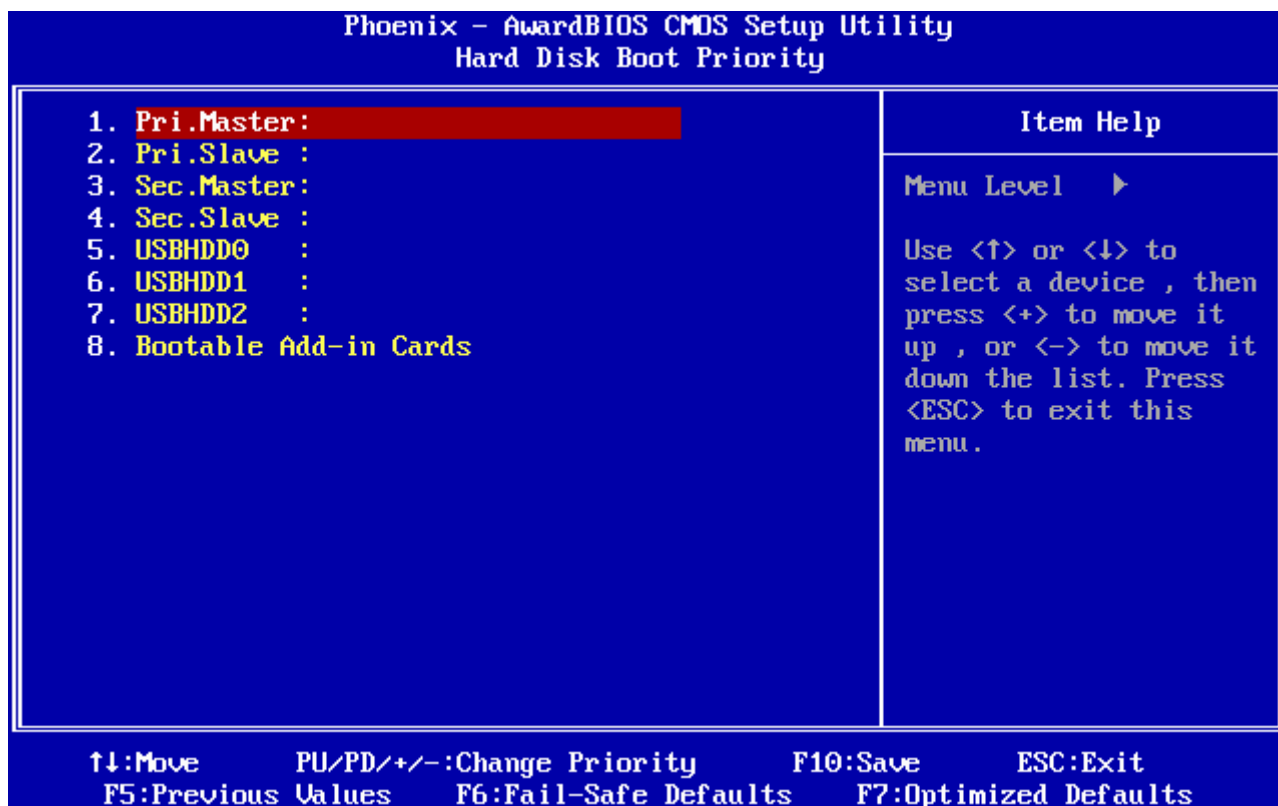

Item	Description
Pri./Sec. Master/Slave	Boot up from IDE Primary/Secondary Master/Slave Hard Disk
USBHDD 0/1/2	Boot up from 1st/2nd/3rd USB Hard Disk
Bootable Add-in Cards	Boot up from other Add-In Card Hard Disk Device.

3.5.2.2 CD-ROM Boot Priority

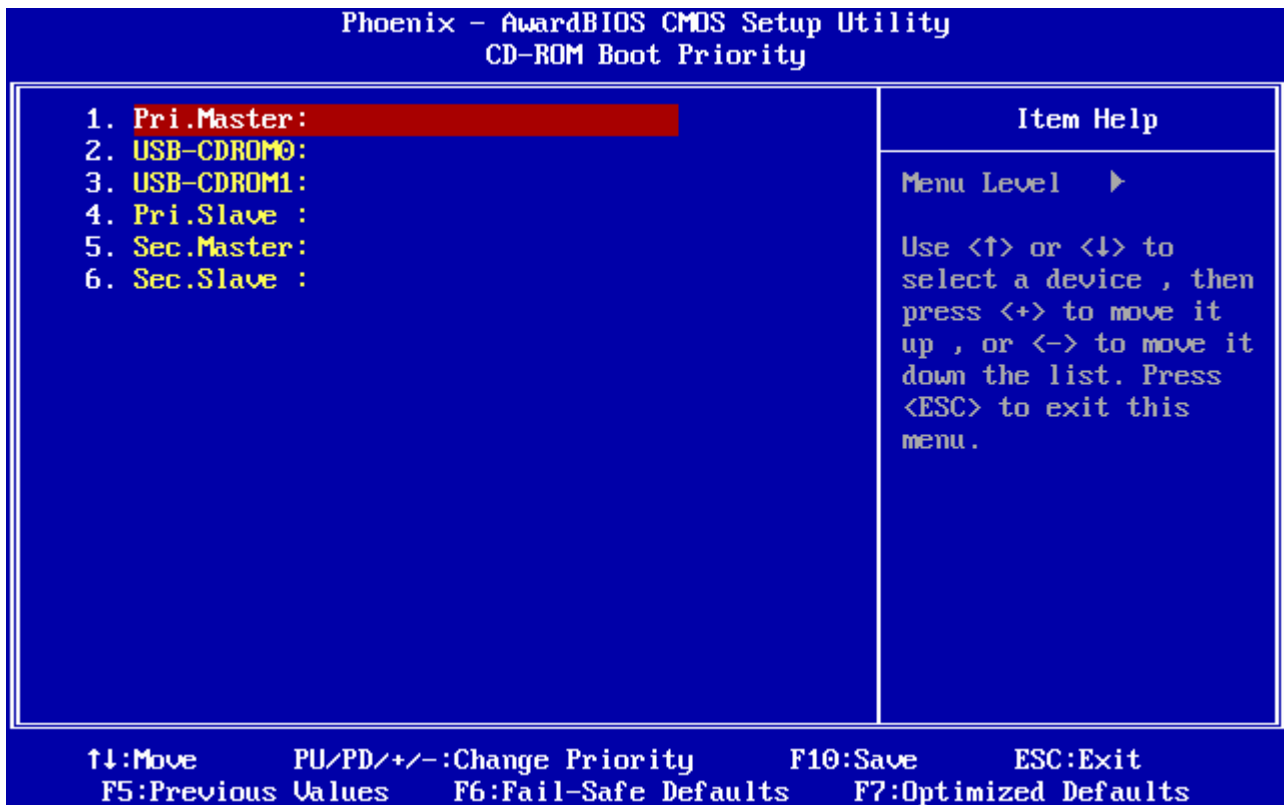

This item allows you to set the boot priority from inserted CD-ROMs.

Item	Description
Pri./Sec. Master/Slave	Boot up from Primary/Secondary Master/Slave CD-ROM
USB-CDROM0/1	Boot up from 1st/2nd CD-ROM

3.5.2.3 Virus Warning

Allows you to choose the VIRUS Warning feature for IDE Hard Disk boot sector protection. If this function is enabled and someone attempt to write data into this area, BIOS will show a warning message on screen and alarm beep.

Item	Description
Enabled	Activates automatically when the system boots up causing a warning message to appear when anything attempts to access the boot sector or hard disk partition table.
Disabled	No warning message will appear when anything attempts to access the boot sector or hard disk partition table.

3.5.2.4 CPU L1 & L2 & L3 Cache

The item allows you to speed up memory access. However, it depends on CPU design.

Item	Description
Enabled	Enable cache
Disabled	Disable cache

3.5.2.5 Hyper-Threading Technology

The item allows you to enable HT Technology. However, it depends on CPU design.

Item	Description
Enabled	Enable cache
Disabled	Disable cache

3.5.2.6 Quick Power On Self Test

This category speeds up Power On Self Test (POST) after you power up the computer. If it is set to Enable, BIOS will shorten or skip some check items during POST.

Item	Description
Enabled	Enable quick POST
Disabled	Normal POST

3.5.2.7 First/Second/Third/Other Boot Device

The BIOS attempts to load the operating system from the devices in the sequence selected in these items.

Item	Description
LS120	LS120 Device
Hard Disk	Hard Disk Device
CDROM	CDROM Device
ZIP100	ZIP-100 Device
USB-FDD	USB Floppy Device
USB-ZIP	USB ZIP Device
USB-CDROM	USB CDROM Device
LAN	Network Device
Disabled	Disabled any boot device

3.5.2.8 Boot Up NumLock Status

Select power on state for NumLock.

Item	Description
On	Enable NumLock
Off	Disable NumLock

3.5.2.9 Typematic Rate Setting

This feature enables you to control the keystroke repeat rate when you depress a key continuously. When enabled, you can manually adjust the settings using the two typematic controls (Typematic Rate and Typematic Delay). If disabled, the BIOS will use the default setting.

Item	Description
Enabled	Enable typematic rate/delay setting
Disabled	Disable typematic rate/delay setting

3.5.2.10 Typematic Rate (Chars/Sec)

This is the rate at which the keyboard will repeat the keystroke if you press it continuously. This setting will only work if Typematic Rate Setting is enabled.

Options: 6, 8, 10, 12, 15, 20, 24, 30

EMX-GM45E

3.5.2.11 Typematic Delay (Msec)

This is the delay, in milliseconds, before the keyboard automatically repeats the keystroke that you have pressed continuously. This setting will only work if Typematic Rate Setting is enabled.

Options: 250, 500, 750, 1000

3.5.2.12 Security Option

Select whether the password is required every time the system boots or only when you enter setup.

Item	Description
System	The system will not boot and access to Setup will be denied if the correct password is not entered at the prompt.
Setup	The system will boot, but access to Setup will be denied if the correct password is not entered at the prompt.



Note: To disable security, select PASSWORD SETTING at Main Menu and then you will be asked to enter password. Do not type anything and just press <Enter>, it will disable security. Once the security is disabled, the system will boot and you can enter Setup freely.

3.5.2.13 APIC Mode

The BIOS supports versions 1.4 of the Intel multiprocessor specification. When enabled, The MPS Version 1.4 Control for OS can be activated.

Options: Enabled/Disabled.

3.5.2.14 MPS Version Control For OS

This feature is only applicable to multiprocessor board as it specifies the version of the Multi-Processor Specification (MPS) that the board will use.

Options: 1.4, 1.1.

3.5.2.15 OS Select for DRAM > 64MB

Select the operating system that is running with greater than 64MB of RAM on the system.

Item	Description
Non-OS2	Disable OS for over 64 MB DRAM
OS2	Enable OS for over 64 MB DRAM

3.5.2.16 Report No FDD For WIN95

The original Windows95 requires the presence of a floppy. Unless the BIOS tells it to disregard the absence of the drive, it will generate an error message. For other operating systems as Win98 etc this field is without relevance.

Item	Description
No	Don't generate error message
Yes	Generate error message

3.5.2.17 Small Logo (EPA) Show

This item allows you enabled/disabled the small EPA logo show on screen at the POST step.

Item	Description
Enabled	EPA Logo show is enabled
Disabled	EPA Logo show is disabled

EMX-GM45E

3.5.3 Advanced Chipset Features

This section allows you to configure the system based on the specific features of the installed chipset. This chipset manages bus speeds and access to system memory resources, such as DRAM and the external cache. It also coordinates communications between the conventional ISA bus and the PCI bus. It must be stated that these items should never need to be altered. The default settings have been chosen because they provide the best operating conditions for your system. The only time you might consider making any changes would be if you discovered that data was being lost while using your system.

The first chipset settings deal with CPU access to dynamic random access memory (DRAM). The default timings have been carefully chosen and should only be altered if data is being lost. Such a scenario might well occur if your system had mixed speed DRAM chips installed so that greater delays may be required to preserve the integrity of the data held in the slower memory chips.

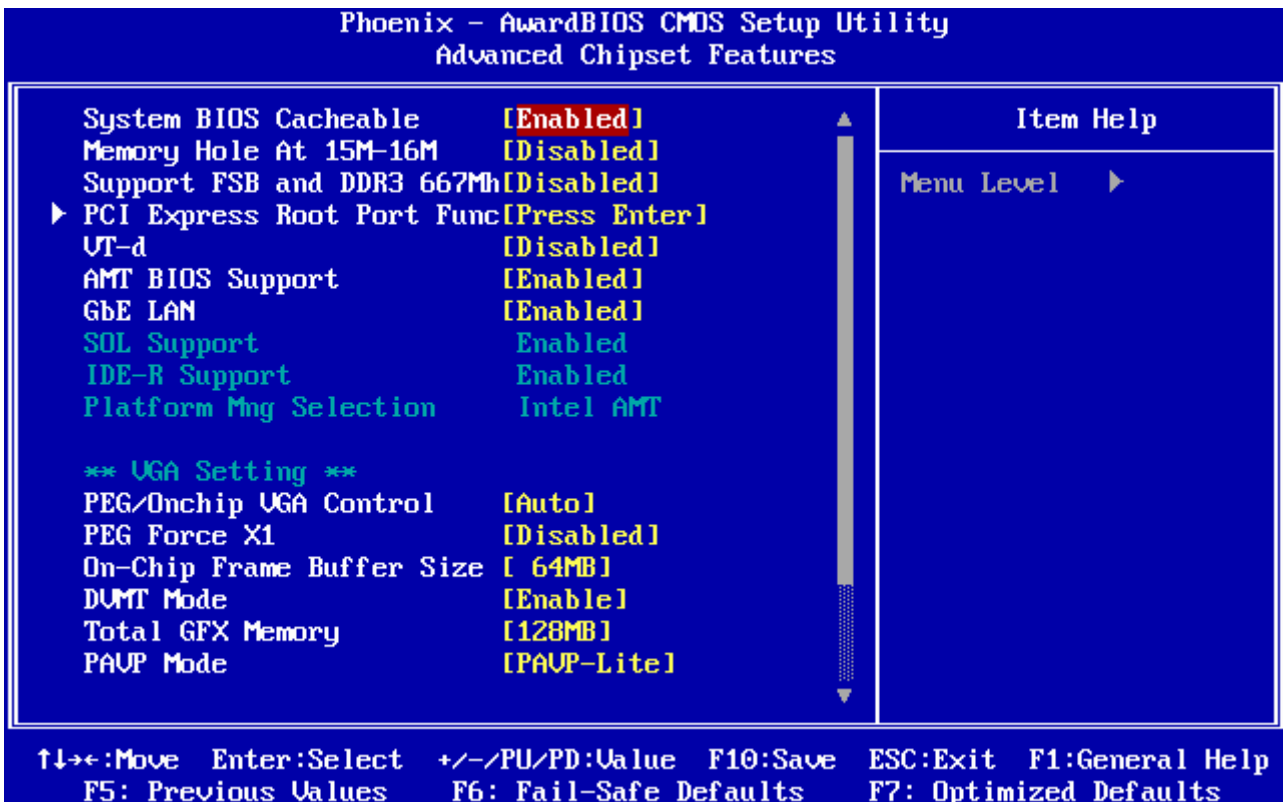

3.5.3.1 System BIOS Cacheable

Enabling this feature allows the caching of the motherboard BIOS ROM from F0000h to FFFFFh by the processor's Level 2 cache. This greatly speeds up accesses to the BIOS.

Options: Disabled, Enabled

3.5.3.2 Memory Hole At 15M-16M

This item controls the time delay (in clock cycles - CLKs) that passes before the SDRAM starts to carry out a read command after receiving it. This also determines the number of CLKs for the completion of the first part of a burst transfer. In other words, the lower the latency, the faster the transaction.

Options: Disabled, Enabled

3.5.3.3 Support FSB and DDR3 667Mh

This option allows you to insert a delay between the RAS (**Row Address Strobe**) and CAS (**Column Address Strobe**) signals. This delay occurs when the SDRAM is written to, read from or refreshed. Naturally, reducing the delay improves the performance of the SDRAM while increasing it reduces performance.

Options: Disabled, Enabled

3.5.3.4 PCI Express Root Port Func

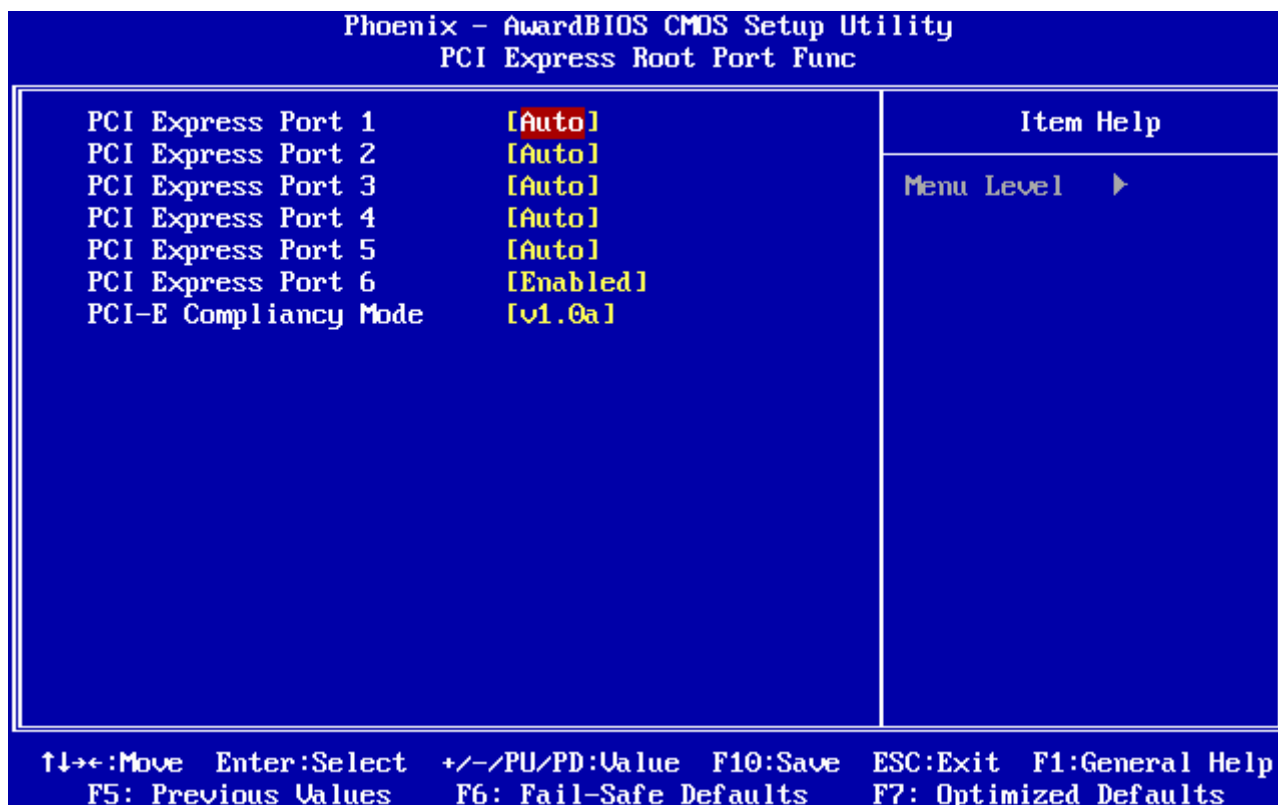

EMX-GM45E

For PCI Express root ports, the assignment of a function number to a root port is not fixed. This item allows you to re-assign the function numbers on a port to port basis. You can disable/hide any root port.

Options: Auto, Enabled, Disabled.

3.5.3.5 VT-d

It allows controlling the memory bank's minimum row active time (tRAS). This constitutes the time when a row is activated until the time the same row can be deactivated. If the tRAS period is too long, it can reduce performance by unnecessarily delaying the deactivation of active rows. Reducing the tRAS period allows the active row to be deactivated earlier. If the tRAS period is too short, there may not be enough time to complete a burst transfer. This reduces performance and data may be lost or corrupted.

Options: Disabled, Enabled

3.5.3.6 AMT BIOS support

This item allows setting AMT BIOS support mode.

Options: Enabled, Disabled.

3.5.3.7 GbE LAN

This item allows setting GbE LAN mode.

Options: Enabled, Disabled.

3.5.3.8 VGA Setting

Item	Options	Description
PEG/ Onchip VGA Control	Onchip VGA PEG Port Auto	It allows controlling the system memory frequency. The memory frequency will either be equal to or less than the processor system bus frequency.
PEG Force X1	Disabled, Enabled	This BIOS feature allows you to convert a PCI Express X16 slot into a PCI Express X1 slot. When enabled, the PCI Express X16 slot will be forced to run in the PCI Express X1 mode. When disabled, the PCI Express X16 slot will be allowed to run in its normal PCI Express X16 mode.
On-Chip Frame Buffer Size	32 MB, 64 MB, 128 MB	This item is to select the amount of system memory that will be utilized as internal graphics device memory.
DVMT Mode	Disabled, Enabled	This feature allows you to select the Dynamic Video Memory Technology (DVMT) operating mode.
Total GFX Memory	128 MB, 256 MB, MAX	
PAVP Mode	Disable, PAVP-Lite, PAVP-High	

3.5.3.9 VGA Boot Device Setting

Item	Options	Description
Boot Display	VBIOS Default CRT LFP AUTO	This feature allows you to select the display device when you boot up the system.

EMX-GM45E

3.5.4 Integrated Peripherals

Use this menu to specify your settings for integrated peripherals.

Phoenix – AwardBIOS CMOS Setup Utility		Item Help
Integrated Peripherals		Menu Level ▶
▶ OnChip IDE Device	[Press Enter]	
▶ Onboard Device	[Press Enter]	
▶ SuperIO Device	[Press Enter]	
▶ Watch Dog Timer Select	[Disabled]	
▶ USB Device Setting	[Press Enter]	

↑↓←→:Move Enter:Select +/-/PU/PD:Value F10:Save ESC:Exit F1:General Help
 F5: Previous Values F6: Fail-Safe Defaults F7: Optimized Defaults

3.5.4.1 OnChip IDE Device

Phoenix – AwardBIOS CMOS Setup Utility		Item Help
OnChip IDE Device		Menu Level ▶
IDE HDD Block Mode	[Enabled]	
IDE DMA transfer access	[Enabled]	
IDE Primary Master PIO	[Auto]	
IDE Primary Slave PIO	[Auto]	
IDE Primary Master UDMA	[Auto]	
IDE Primary Slave UDMA	[Auto]	
On-Chip Secondary PCI IDE	[Enabled]	
IDE Secondary Master PIO	[Auto]	
IDE Secondary Slave PIO	[Auto]	
IDE Secondary Master UDMA	[Auto]	
IDE Secondary Slave UDMA	[Auto]	
LEGACY Mode Support	[Disabled]	

If your IDE hard drive supports block mode select Enabled for automatic detection of the optimal number of block read/writes per sector the drive can support

↑↓←→:Move Enter:Select +/-/PU/PD:Value F10:Save ESC:Exit F1:General Help
 F5: Previous Values F6: Fail-Safe Defaults F7: Optimized Defaults

The chipset contains a PCI IDE interface with support for one IDE channel and two SATA channels. Select Enabled to activate the primary IDE interface. Select Disabled to deactivate this interface.

Item	Options	Description
IDE HDD Block Mode	Enabled Disabled	Speeds up HDD access by transferring data from multiple sectors at once instead of using the old single sector transfer mode if the HDD supports block transfers and configure the proper block transfer settings for it. Up to 64KB of data can be transferred per interrupt with IDE HDD Block Mode enabled. (Virtually all HDDs now support block transfers.)
IDE DMA transfer access	Enabled Disabled	It allows you to enable or disable DMA (Direct Memory Access) support for all IDE devices. If you disable this BIOS feature, the BIOS will disable DMA transfers for all IDE drives. They will revert to PIO mode transfers. If you enable this BIOS feature, the BIOS will enable DMA transfers for all IDE drives. The proper DMA mode will be detected at boot-up. If the drive does not support DMA transfers, then it will use PIO mode instead.
On-Chip Primary/Secondary PCI IDE	Enabled Disabled	The integrated peripheral controller contains an IDE interface with support for two IDE channels. It allows you to activate each channel separately.
IDE Primary Master PIO IDE Primary Slave PIO IDE Secondary Master PIO IDE Secondary Slave PIO	Auto Mode 0 Mode 1 Mode 2 Mode 3 Mode 4	The IDE PIO (Programmed Input/Output) fields let you set a PIO mode (0-4) for each of the four IDE devices that the onboard IDE interface supports. Modes 0 through 4 provide successively increased performance. In Auto mode, the system automatically determines the best mode for each device.
IDE Primary Master UDMA IDE Primary Slave UDMA IDE Secondary Master UDMA IDE Secondary Slave UDMA	Auto Disabled	Ultra DMA implementation is possible only if your IDE hard drive supports it and the operating environment includes a DMA driver (Windows 95 OSR2 or a third-party IDE bus master driver). If the hard drive and the system software both support Ultra DMA, select Auto to enable BIOS support.

3.5.4.1.1 LEGACY Mode Support

Computing, legacy mode is a state in which a computer system, component, or software application behaves in a way different from its standard operation in order to support older software, data, or expected behavior. It differs from backward compatibility in that an item in this state will often sacrifice newer features or performance, or be unable to access data or run programs it normally could, in order to provide continued access to older data or functionality. Sometimes it can allow newer technologies that replaced the old to emulate them when running older operating systems

EMX-GM45E

3.5.4.2 Onboard Device

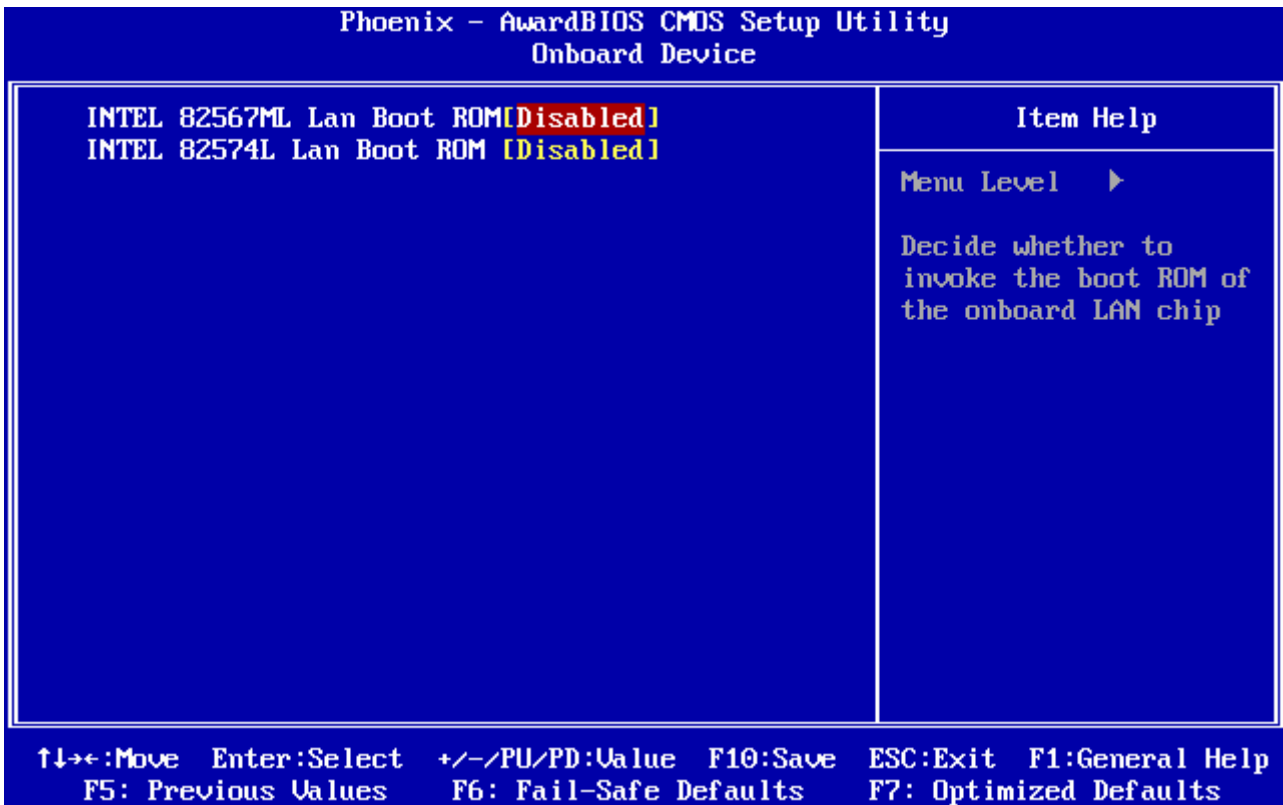

Item	Options	Description
Intel 82567ML Lan Boot ROM	Enabled Disabled	Enable or Disable Intel 82567ML Lan Boot ROM
Intel 82574L Lan Boot ROM	Enabled Disabled	Enable or Disable Intel 82574L Lan Boot ROM

3.5.4.3 Super IO Device

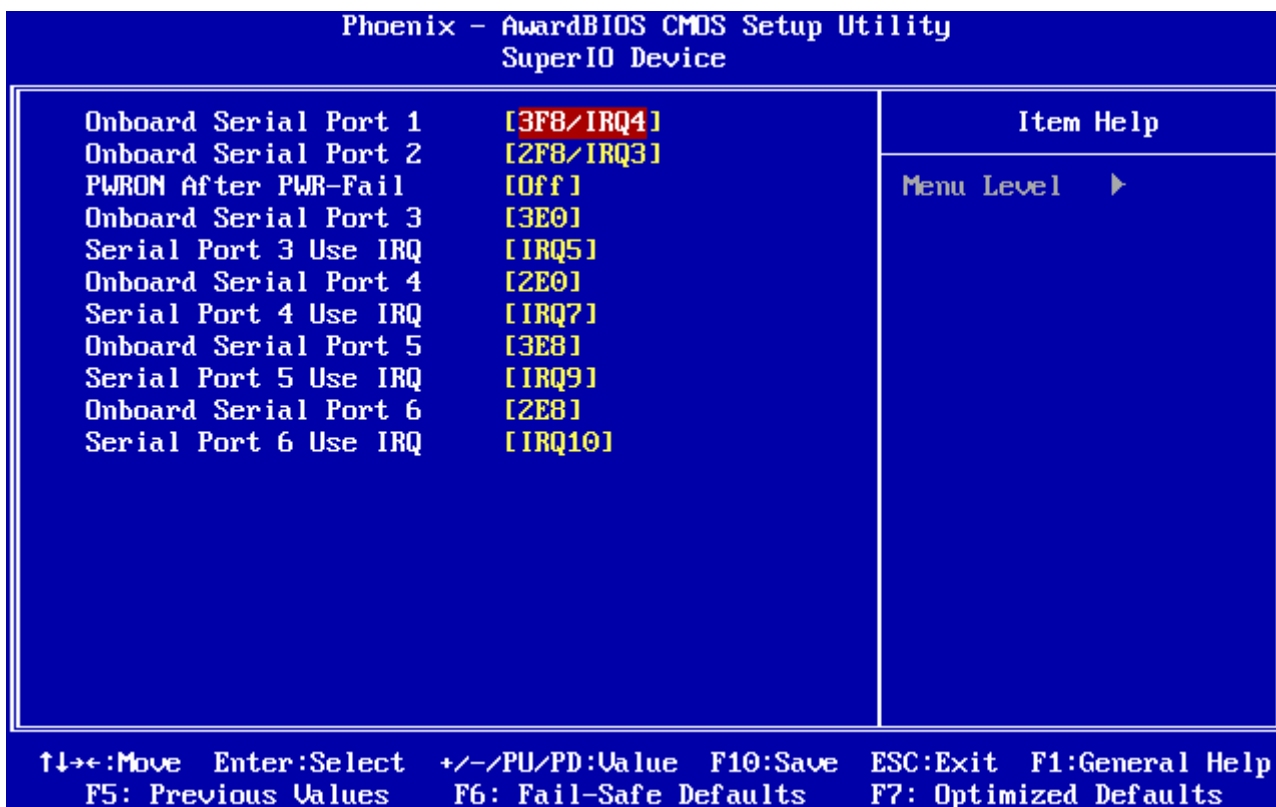

Item	Options	Description
Onboard Serial Port 1 Onboard Serial Port 2	Disabled, 3F8/IRQ4 2F8/IRQ3, 3E8/IRQ4 2E8/IRQ3, Auto	Select an address and corresponding interrupt for the first and second serial ports.
PWRON After PWR-Fail	On / Off / Former-Sts	This BIOS feature allows you to set the PC to automatically start itself up after a power failure. When set to On , the PC will automatically start up when power is restored. When set to Off , the PC will remain powered off even when power is restored.
Onboard Serial Port 3 Onboard Serial Port 4 Onboard Serial Port 5 Onboard Serial Port 6	Disabled, 3E0, 2E0, 3E8, 2E8	Select an address and corresponding interrupt for the third to sixth serial ports.
Serial Port 3 Use IRQ Serial Port 4 Use IRQ Serial Port 5 Use IRQ Serial Port 6 Use IRQ	IRQ3, IRQ4,IRQ5,IRQ7,IRQ9 ,IRQ10,IRQ11	Select an address and corresponding interrupt for the third to sixth serial ports.

EMX-GM45E

3.5.4.4 Watch Dog Timer

This option will determine watch dog timer.

Options: Disabled, 10, 20, 30, 40 Sec, 1, 2, 4 Min.

3.5.4.5 USB Device Setting

Phoenix - AwardBIOS CMOS Setup Utility
USB Device Setting

USB 1.0 Controller	[Enabled]	Item Help
USB 2.0 Controller	[Enabled]	
USB Operation Mode	[High Speed]	Menu Level ▶
USB Keyboard Function	[Enabled]	[Enable] or [Disable]
USB Mouse Function	[Enabled]	Universal Host
USB Storage Function	[Enabled]	Controller Interface
*** USB Mass Storage Device Boot Setting ***		for Universal Serial
UFDDA	USB Floppy	Bus.
UFDBB	USB Floppy	
No Device	[Auto mode]	
No Device	[Auto mode]	
No Device	[Auto mode]	
No Device	[Auto mode]	
No Device	[Auto mode]	
No Device	[Auto mode]	
No Device	[Auto mode]	
No Device	[Auto mode]	
No Device	[Auto mode]	

↑↓←→: Move Enter: Select +/-/PU/PD: Value F10: Save ESC: Exit F1: General Help
F5: Previous Values F6: Fail-Safe Defaults F7: Optimized Defaults

Item	Options	Description
USB 1.0 Controller	Disabled Enabled	This item enables you to use the onboard USB 1.0 controller to communicate with your USB devices
USB 2.0 Controller	Disabled Enabled	This item enables you to use the onboard USB 2.0 controller to communicate with your USB devices
USB Operation Mode	Full/Low Speed High Speed	This item allows you to select the USB mode.
USB Keyboard Function	Disabled Enabled	This BIOS feature determines if support for the USB keyboard should be provided by the operating system or the BIOS.
USB Mouse Function	Disabled Enabled	This BIOS feature determines if support for the USB mouse should be provided by the operating system or the BIOS.
USB Storage Function	Disabled Enabled	This BIOS feature determines if support for the USB Storage should be provided by the operating system or the BIOS.

3.5.5 Power Management Setup

The Power Management Setup allows you to configure you system to most effectively save energy while operating in a manner consistent with your own style of computer use.

Phoenix - AwardBIOS CMDS Setup Utility
Power Management Setup

<ul style="list-style-type: none"> ▶ PCI Express PM Function [Press Enter] ACPI Function [Enabled] ACPI Suspend Type [S3(STR)] Run UGABIOS if S3 Resume [Auto] Power Management [Min Saving] Video Off Method [DPMS] Video Off In Suspend [Yes] Suspend Type [Stop Grant] MODEM Use IRQ [3] Suspend Mode 1 Hour HDD Power Down 15 Min Soft-Off by PWR-BTIN [Instant-Off] Power On by Ring [Enabled] Resume by Alarm [Disabled] × Date(of Month) Alarm 0 × Time(hh:mm:ss) Alarm 0 : 0 : 0 *** Reload Global Timer Events *** Primary IDE 0 [Disabled] 	<table border="1" style="width: 100%; border-collapse: collapse;"> <tr> <th style="text-align: center;">Item Help</th> </tr> <tr> <td style="padding: 5px;">Menu Level ▶</td> </tr> </table>	Item Help	Menu Level ▶
Item Help			
Menu Level ▶			

↑↓←→:Move Enter:Select +/-/PU/PD:Ualue F10:Save ESC:Exit F1:General Help
 F5: Previous Values F6: Fail-Safe Defaults F7: Optimized Defaults

3.5.5.1 PCI Express PM Function

Phoenix - AwardBIOS CMDS Setup Utility
PCI Express PM Function

<ul style="list-style-type: none"> PEG Port ASPM [Disabled] Root Port ASPM [Disabled] PCI Express PME [Enabled] DMI Port ASPM [Disabled] 	<table border="1" style="width: 100%; border-collapse: collapse;"> <tr> <th style="text-align: center;">Item Help</th> </tr> <tr> <td style="padding: 5px;">Menu Level ▶</td> </tr> </table>	Item Help	Menu Level ▶
Item Help			
Menu Level ▶			

↑↓←→:Move Enter:Select +/-/PU/PD:Ualue F10:Save ESC:Exit F1:General Help
 F5: Previous Values F6: Fail-Safe Defaults F7: Optimized Defaults

EMX-GM45E

This item allows you to enable/disable the PCI Express PME Function.

Options: Enabled, Disabled.

3.5.5.2 ACPI Function

This item allows you to enable/disable the ACPI function.

Options: Enabled, Disabled.

3.5.5.3 ACPI Suspend Type

This item will set which ACPI suspend type will be used.

Options: S1(POS), S3(STR).S1&S3.

3.5.5.4 Run VGABIOS if S3 Resume

There are 3 modes for you to decide to operate VGABIOS or not when the ACPI suspend type is S3.

Options: Auto, Yes, No.

3.5.5.5 Power Management

This category allows you to select the type (or degree) of power saving and is directly related to the following modes:

Item	Description
User Defined	Allows you to set each mode individually. When not disabled, each of the ranges are from 1 min. to 1 hr. except for HDD Power Down which ranges from 1 min. to 15 min. and disable.
Min. Saving	Minimum power management, HDD Power Down = 15 Min,
Max. Saving	Maximum power management, HDD Power Down =1 Min,

3.5.5.6 Video Off Method

This determines the manner in which the monitor is blanked.

Options: Blank Screen, V/H SYNC+Blank, DPMS.

3.5.5.7 Video Off In Suspend

This determines the manner in which the monitor is blanked.

Options: No, Yes.

3.5.5.8 Suspend Type

This function allows to select Suspend type.

Options: Stop Grant, PwrOn Suspend.

3.5.5.9 MODEM Use IRQ

This determines the IRQ in which the MODEM can use.

Options: NA, 3, 4, 5, 7, 9, 10, 11.

3.5.5.10 Suspended Mode

It specifies the length of time of system inactivity while in full power on state before the computer enters suspend mode and motivates the enable 'Wake Up Events In Doze & Standby' / 'PM Events'.

Options: Disabled, 1, 2, 4, 8, 12, 20, 30, 40 mins, 1 hr.

3.5.5.11 HDD Power Down

When enable and after the set time of system inactivity, the hard disk drive will be powered down while all other devices remain active.

Options: Disabled, 1 ~ 15 mins.

3.5.5.12 Soft-Off by PWR-BTTN

Pressing the power button for more than 4 seconds forces the system to enter the Soft-Off state when the system has "hung".(Only could working on ATX Power supply)

Options: Delay 4 Sec, Instant-Off.

3.5.5.13 Power On By Ring

This determines whether the system boot up if there's an incoming call from the Modem.

Options: Enable, Disabled.

3.5.5.14 Resume by Alarm

This function sets date and time for your computer to boot up.

Options: Enabled, Disabled.

3.5.5.15 Date<of Month>/Time<hh:mm:ss> Alarm

After enabling "Resume By Alarm", set the specific date/hour/minute/second specified in these fields.

Options:: Alarm Date: 01-31, Every Day / Alarm Hour: 00-23 /

Alarm Minute: 00-59/ Alarm Second: 00-59

3.5.5.16 Primary/Secondary IDE 0/1, FDD,COM,LPT PORT, PCI PIRQ[A-D]#

Reload Global Timer events are I/O events whose occurrence can prevent the system from entering a power saving mode or can awake the system from such a mode. In effect ,the system remain alert for anything which occurs to a device which is configured as Enabled ,even when the system is in a power down mode.

Options: Enabled, Disabled.

EMX-GM45E

3.5.6 PnP / PCI Configuration

This section describes configuring the PCI bus system. PCI, or **P**ersonal **C**omputer **I**nterconnect, is a system which allows I/O devices to operate at speeds nearing the speed the CPU itself uses when communicating with its own special components. This section covers some very technical items and it is strongly recommended that only experienced users should make any changes to the default settings.

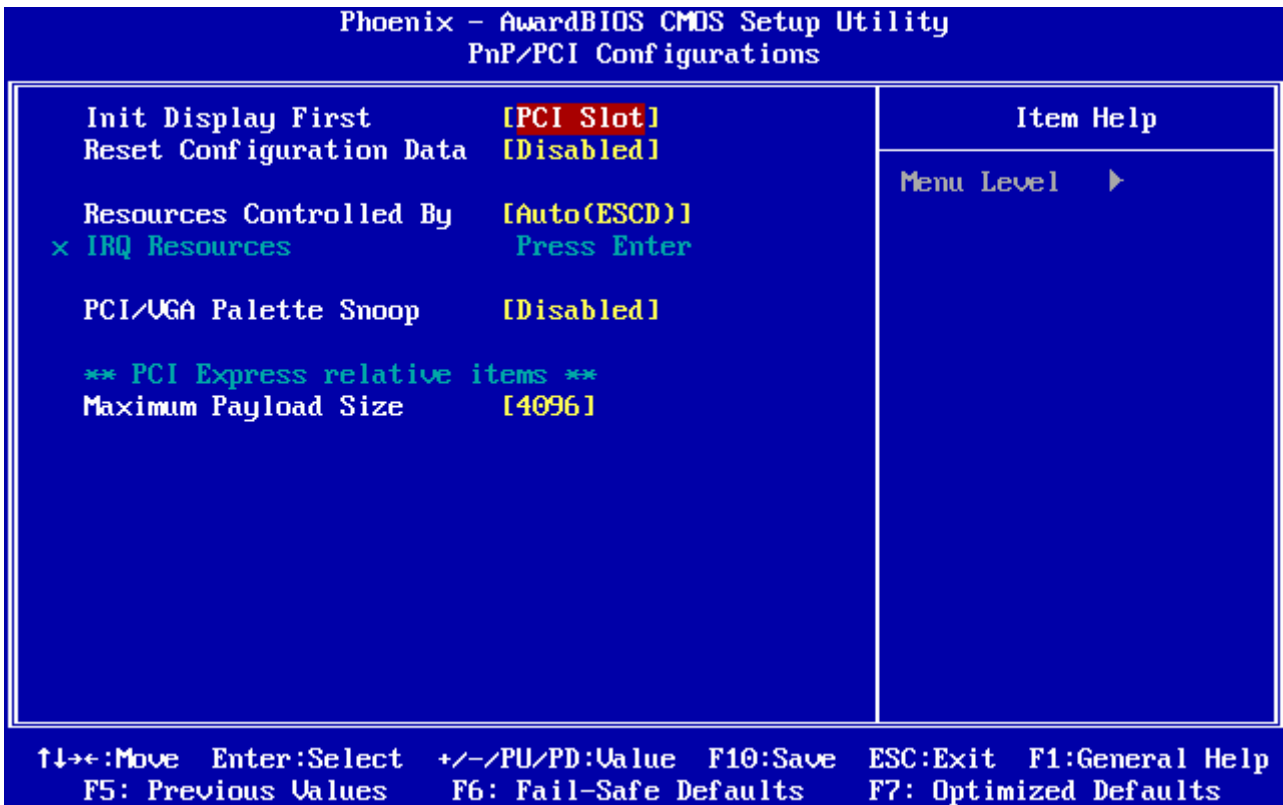

3.5.6.1 Init Display First

It allows you to select whether to boot the system using the PCI graphics card. This is particularly important if you have PCI graphics cards but only one monitor.

Options:: PCI Slot, Onboard, PCIEx.

3.5.6.2 Reset Configuration Data

Normally, you leave this field Disabled. Select Enabled to reset Extended System Configuration Data (ESCD) when you exit Setup if you have installed a new add-on and the system reconfiguration has caused such a serious conflict that the operating system cannot boot.

Options:: Enabled, Disabled.

3.5.6.3 Resources Controlled By

The Award Plug and Play BIOS has the capacity to automatically configure all of the boot and Plug and Play compatible devices. However, this capability means absolutely nothing unless you are using a Plug and Play operating system such as Windows®95. If you set this field to “manual” choose specific resources by going into each of the sub menu that follows this field (a sub menu is preceded by a “>”).

Options: Auto(ESCD), Manual.

3.5.6.4 PCI / VGA Palette Snoop

Leave this field at Disabled.

Options: Enabled, Disabled.

3.5.6.5 Maximum Payload Size

This setting defines the maximum payload size.

Options: 128, 256, 512, 1024, 2048, 4096.

3.5.7 PC Health Status

This section shows the status of your CPU, Fan & System.

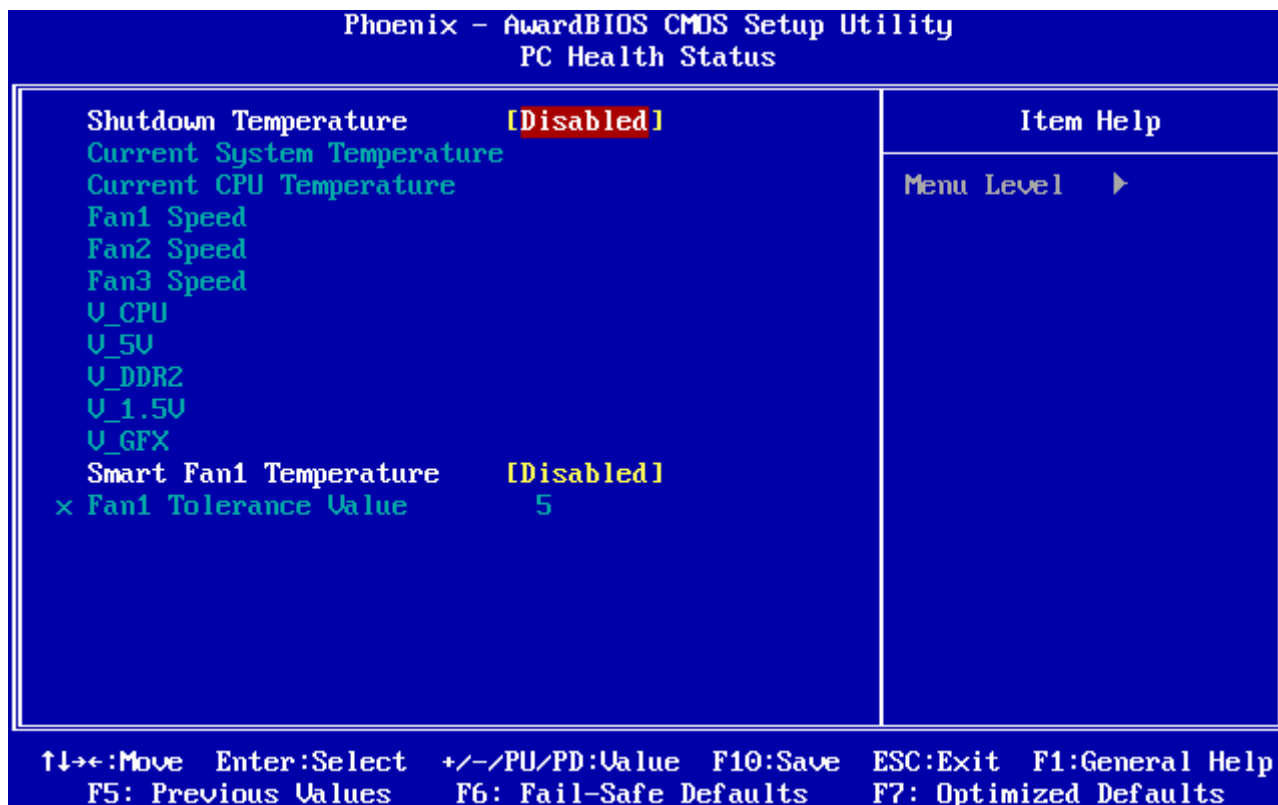

EMX-GM45E

3.5.5 Load Fail-Safe Defaults

Use this menu to load the BIOS default values for the minimal/stable performance for your system to operate.

Press <Y> to load the BIOS default values for the most stable, minimal-performance system operations.

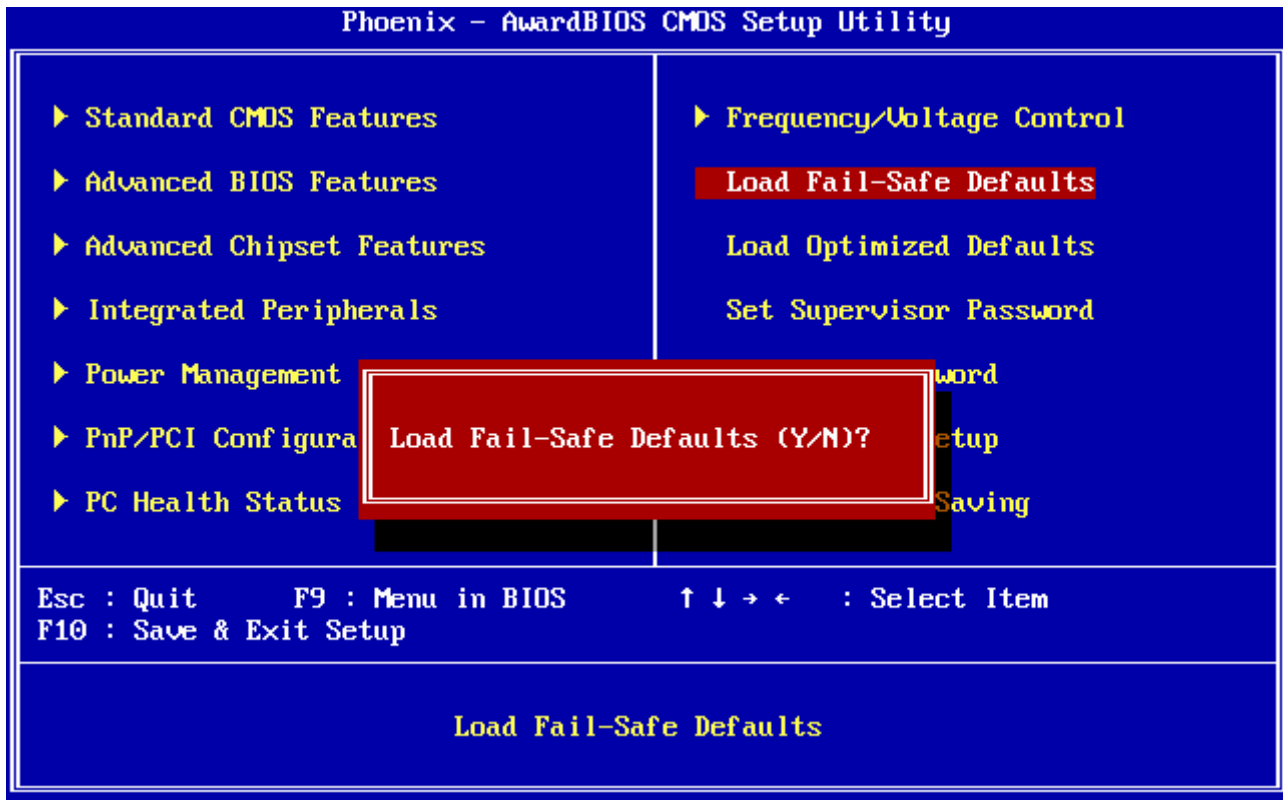

3.5.6 Load Optimized Defaults

Use this menu to load the BIOS default values that are factory settings for optimal performance system operations. While Award has designed the custom BIOS to maximize performance, the factory has the right to change these defaults to meet their needs.

Press <Y> to load the default values setting for optimal performance system operations.

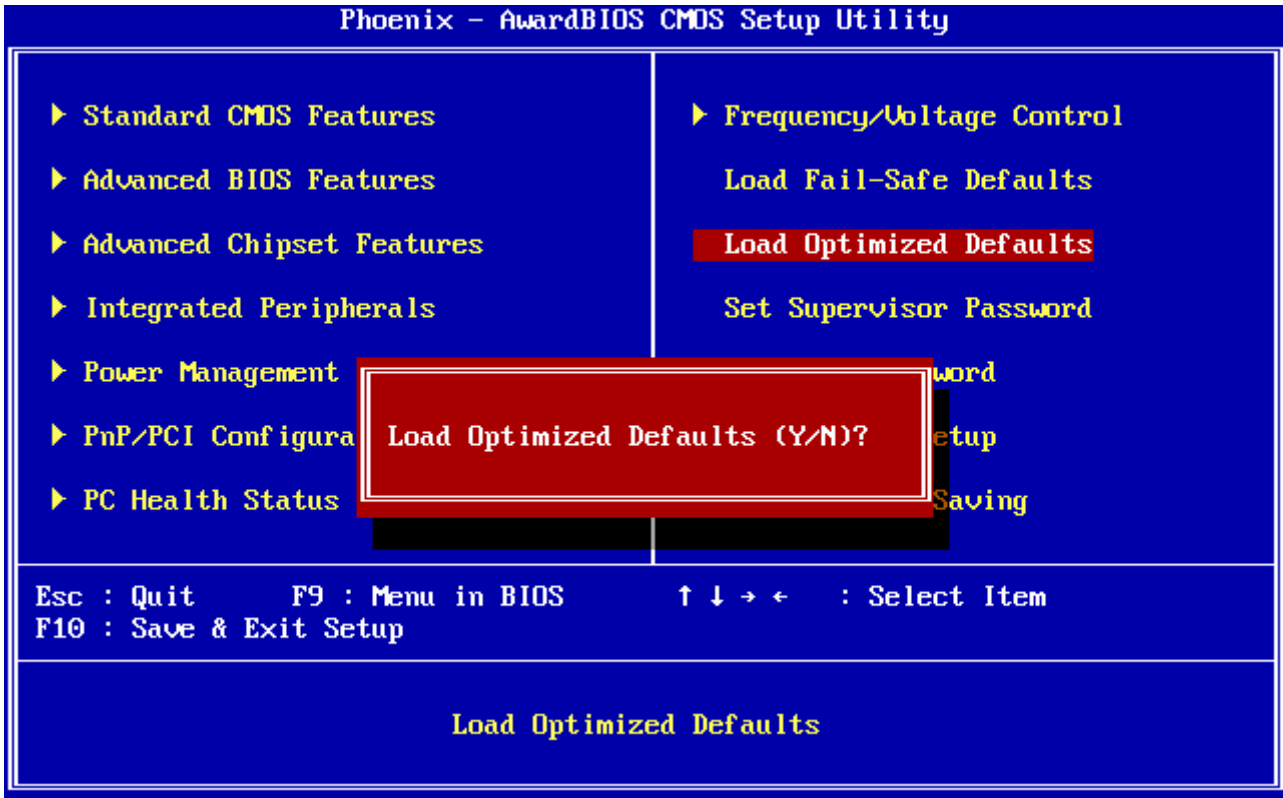

3.5.7 Set Supervisor / User Password

You can set either supervisor or user password, or both of them.

Supervisor Password: able to enter/change the options of setup menus.

EMX-GM45E

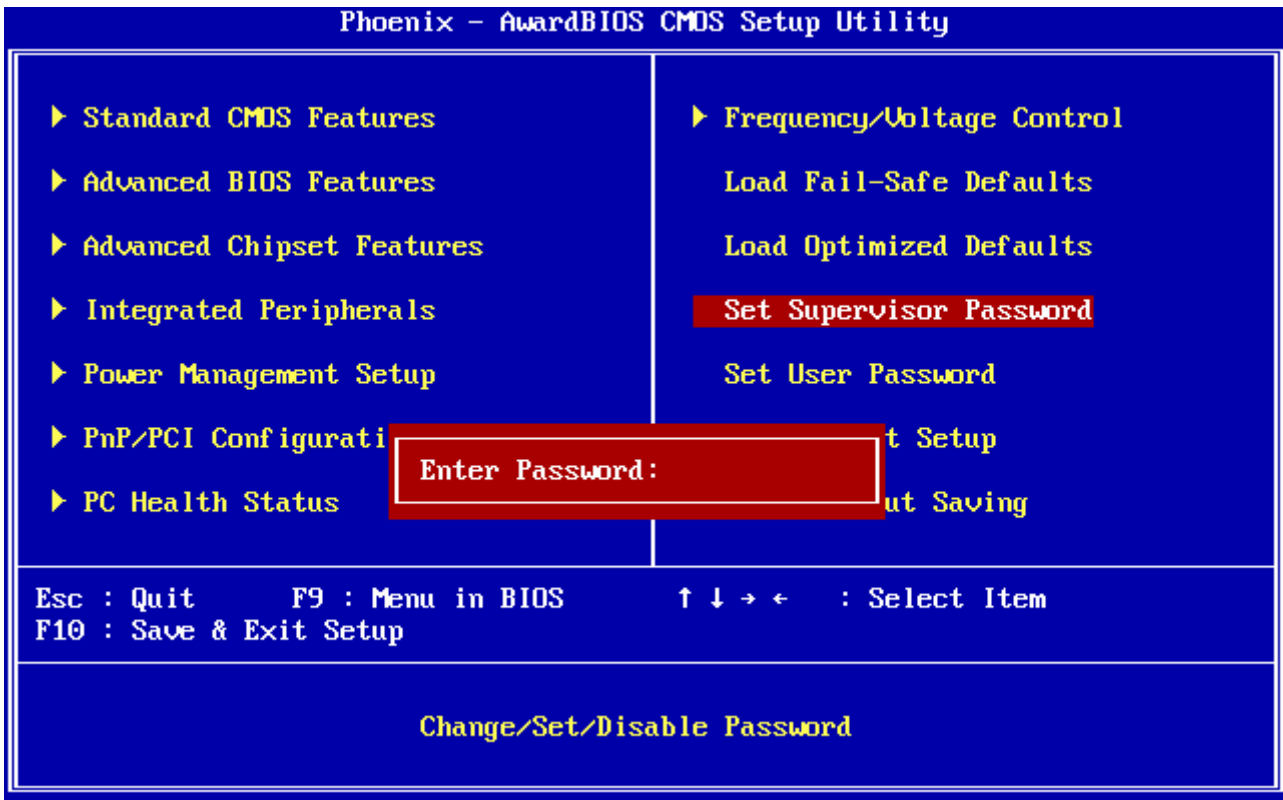

Supervisor Password

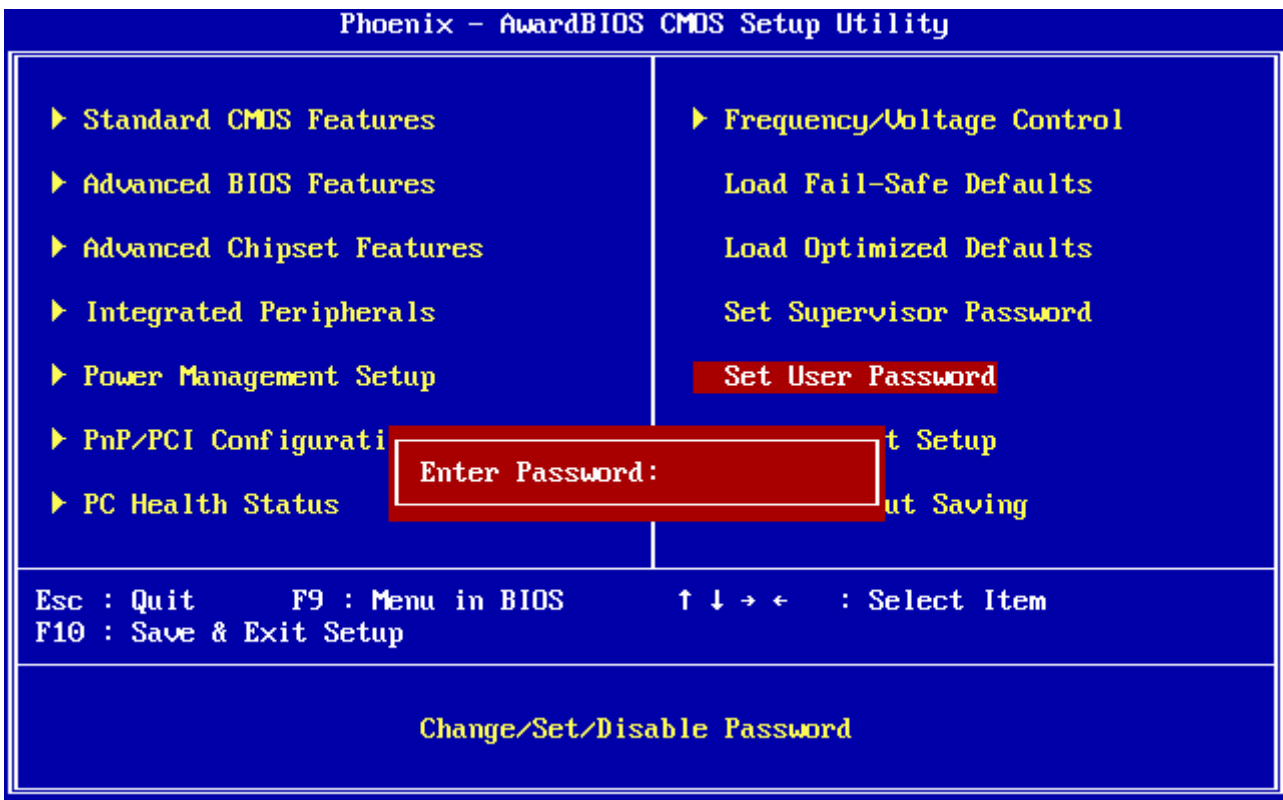

User Password: able to enter but no right to change the options of setup menus.

Type the password, up to eight characters in length, and press <Enter>. The password typed now will clear any previously entered password from CMOS memory. You will be asked to confirm the password. Type the password again and press <Enter>. You may also

press <Esc> to abort the selection and not enter a password. To disable a password, just press <Enter> when you are prompted to enter the password. A message will confirm the password will be disabled. Once the password is disabled, the system will boot and you can enter Setup freely.

PASSWORD DISABLED.

When a password has been enabled, you will be prompted to enter it every time you try to enter Setup. This prevents an unauthorized person from changing any part of your system configuration. Additionally, when a password is enabled, you can also require the BIOS to request a password every time your system is rebooted. This would prevent unauthorized use of your computer. You determine when the password is required within the BIOS Features Setup Menu and its Security option (see Section 3). If the Security option is set to "System", the password will be required both at boot and at entry to Setup. If set to "Setup", prompting only occurs when trying to enter Setup

3.5.8 Save & Exit Setup

Save CMOS value changes to CMOS and exit setup.

Enter <Y> to store the selection made in the menus in CMOS, a special section in memory that stays on after turning the system off. The BIOS configures the system according to the Setup selection stored in CMOS when boot the computer next time.

The system is restarted after saving the values.

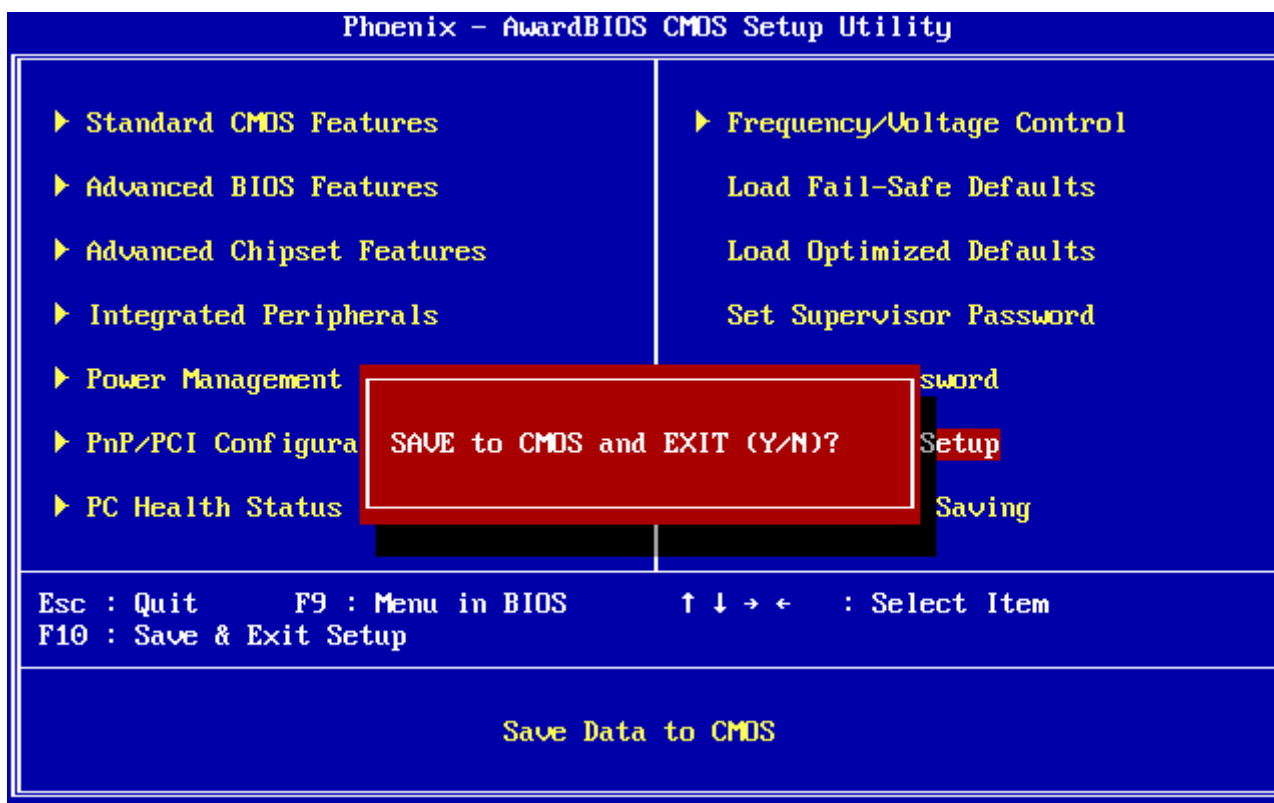

EMX-GM45E

3.5.9 Exit Without Save

Abandon all CMOS value changes and exit setup, and the system is restarted after exiting.

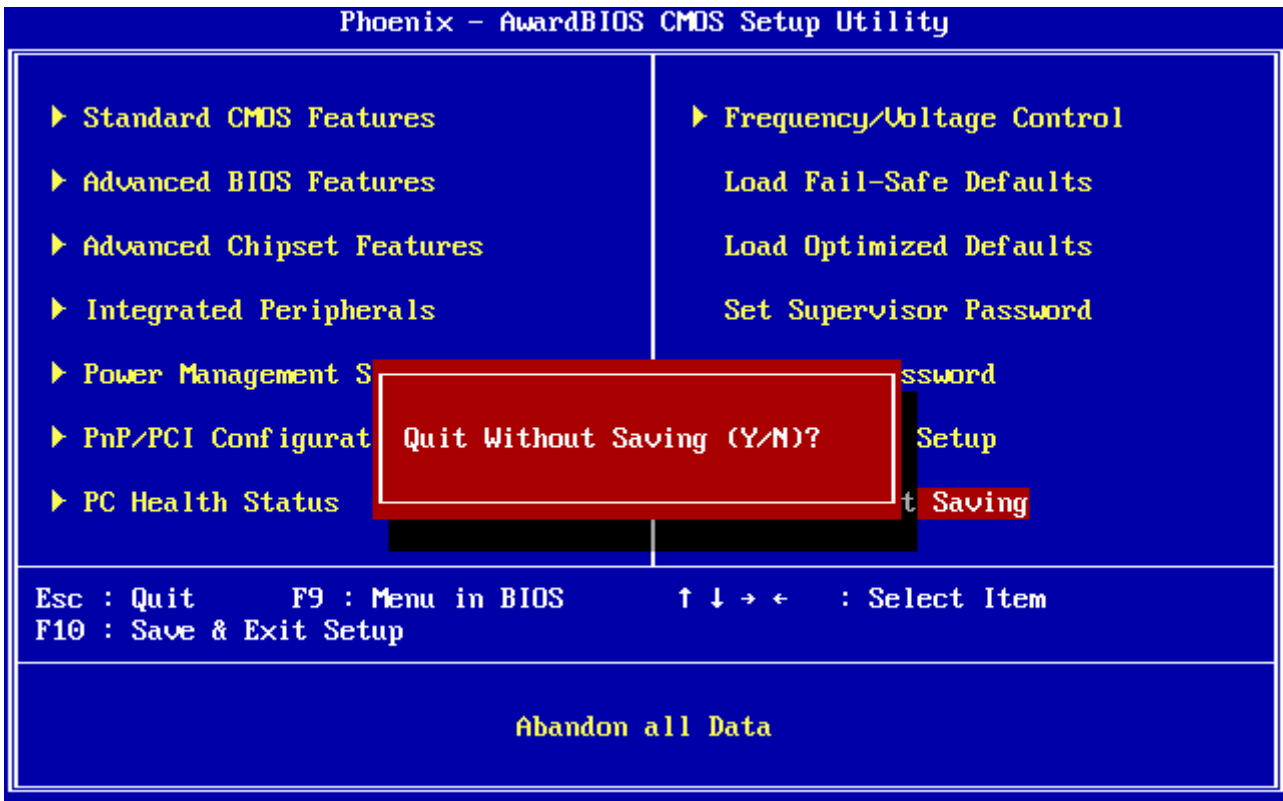

4. Mechanical Drawing



EMX-GM45E

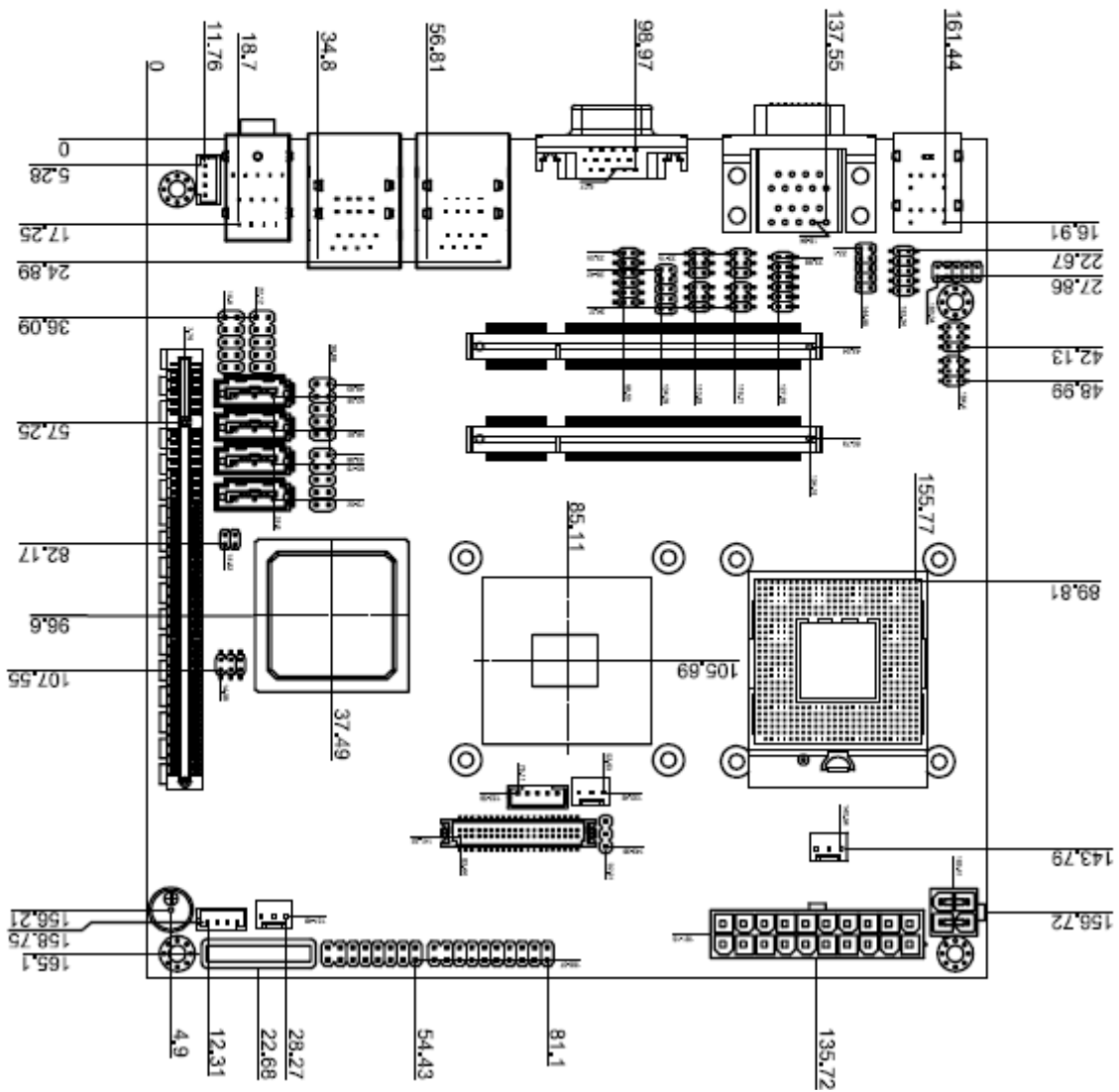
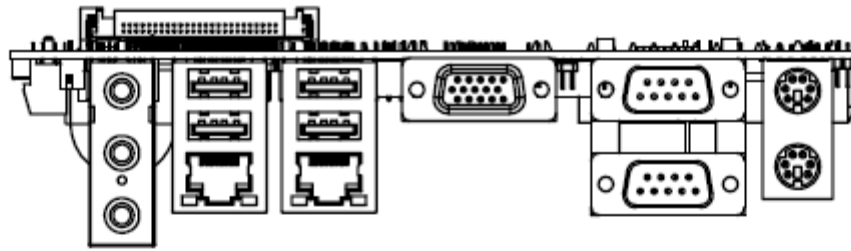

Unit: mm

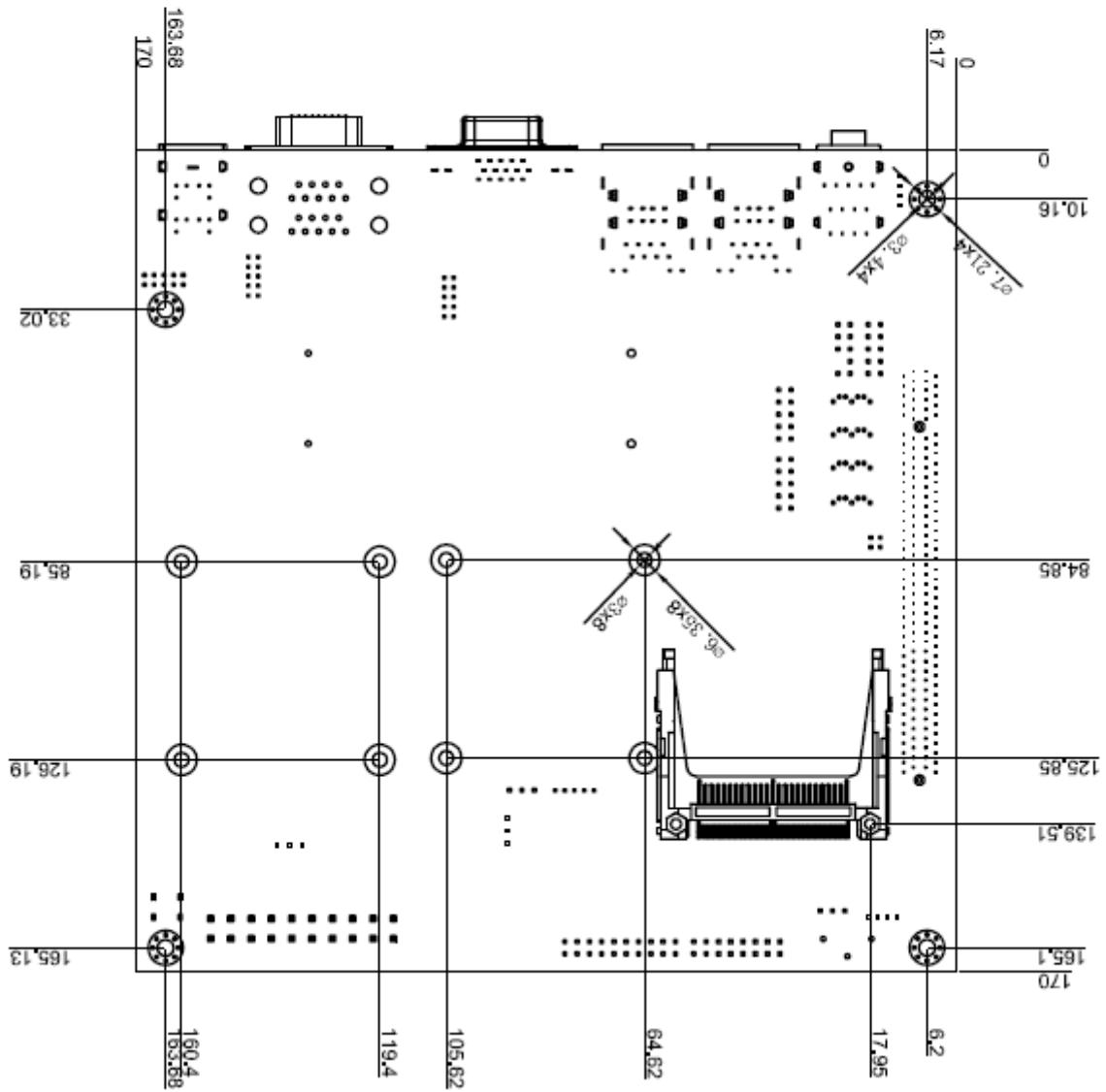

Unit: mm

