

ECM-QM87R/ ECM-QM87

Intel® 4th Generation Core™ Processor 3.5" Micro Module
with Intel® Lynx Point Chipset

User's manual

1st Ed – 12 December 2014

FCC Statement



THIS DEVICE COMPLIES WITH PART 15 FCC RULES. OPERATION IS SUBJECT TO THE FOLLOWING TWO CONDITIONS:

(1) THIS DEVICE MAY NOT CAUSE HARMFUL INTERFERENCE.

(2) THIS DEVICE MUST ACCEPT ANY INTERFERENCE RECEIVED INCLUDING INTERFERENCE THAT MAY CAUSE UNDESIRE OPERATION.

THIS EQUIPMENT HAS BEEN TESTED AND FOUND TO COMPLY WITH THE LIMITS FOR A CLASS "A" DIGITAL DEVICE, PURSUANT TO PART 15 OF THE FCC RULES.

THESE LIMITS ARE DESIGNED TO PROVIDE REASONABLE PROTECTION AGAINST HARMFUL INTERFERENCE WHEN THE EQUIPMENT IS OPERATED IN A COMMERCIAL ENVIRONMENT. THIS EQUIPMENT GENERATES, USES, AND CAN RADIATE RADIO FREQUENCY ENERGY AND, IF NOT INSTALLED AND USED IN ACCORDANCE WITH THE INSTRUCTION MANUAL, MAY CAUSE HARMFUL INTERFERENCE TO RADIO COMMUNICATIONS.

OPERATION OF THIS EQUIPMENT IN A RESIDENTIAL AREA IS LIKELY TO CAUSE HARMFUL INTERFERENCE IN WHICH CASE THE USER WILL BE REQUIRED TO CORRECT THE INTERFERENCE AT HIS OWN EXPENSE.

Notice

This guide is designed for experienced users to setup the system within the shortest time. For detailed information, please always refer to the electronic user's manual.

Copyright Notice

Copyright © 2014 Avalue Technology Inc., ALL RIGHTS RESERVED.

No part of this document may be reproduced, copied, translated, or transmitted in any form or by any means, electronic or mechanical, for any purpose, without the prior written permission of the original manufacturer.

Trademark Acknowledgement

Brand and product names are trademarks or registered trademarks of their respective owners.

Disclaimer

Avalue Technology Inc. reserves the right to make changes, without notice, to any product, including circuits and/or software described or contained in this manual in order to improve design and/or performance. Avalue Technology assumes no responsibility or liability for the use of the described product(s), conveys no license or title under any patent, copyright, or masks work rights to these products, and makes no representations or warranties that

these products are free from patent, copyright, or mask work right infringement, unless otherwise specified. Applications that are described in this manual are for illustration purposes only. Avalue Technology Inc. makes no representation or warranty that such application will be suitable for the specified use without further testing or modification.

Life Support Policy

Avalue Technology's PRODUCTS ARE NOT FOR USE AS CRITICAL COMPONENTS IN LIFE SUPPORT DEVICES OR SYSTEMS WITHOUT THE PRIOR WRITTEN APPROVAL OF Avalue Technology Inc.

As used herein:

1. Life support devices or systems are devices or systems which, (a) are intended for surgical implant into body, or (b) support or sustain life and whose failure to perform, when properly used in accordance with instructions for use provided in the labeling, can be reasonably expected to result in significant injury to the user.
2. A critical component is any component of a life support device or system whose failure to perform can be reasonably expected to cause the failure of the life support device or system, or to affect its safety or effectiveness.

A Message to the Customer

Avalue Customer Services

Each and every Avalue's product is built to the most exacting specifications to ensure reliable performance in the harsh and demanding conditions typical of industrial environments. Whether your new Avalue device is destined for the laboratory or the factory floor, you can be assured that your product will provide the reliability and ease of operation for which the name Avalue has come to be known.

Your satisfaction is our primary concern. Here is a guide to Avalue's customer services. To ensure you get the full benefit of our services, please follow the instructions below carefully.

Technical Support

We want you to get the maximum performance from your products. So if you run into technical difficulties, we are here to help. For the most frequently asked questions, you can easily find answers in your product documentation. These answers are normally a lot more detailed than the ones we can give over the phone. So please consult the user's manual first.

To receive the latest version of the user's manual; please visit our Web site at:

<http://www.avalue.com.tw/>

ECM-QM87R/ ECM-QM87

Product Warranty

Avalue warrants to you, the original purchaser, that each of its products will be free from defects in materials and workmanship for two years from the date of purchase.

This warranty does not apply to any products which have been repaired or altered by persons other than repair personnel authorized by Avalue, or which have been subject to misuse, abuse, accident or improper installation. Avalue assumes no liability under the terms of this warranty as a consequence of such events. Because of Avalue's high quality-control standards and rigorous testing, most of our customers never need to use our repair service. If any of Avalue's products is defective, it will be repaired or replaced at no charge during the warranty period. For out-of-warranty repairs, you will be billed according to the cost of replacement materials, service time, and freight. Please consult your dealer for more details. If you think you have a defective product, follow these steps:

1. Collect all the information about the problem encountered. (For example, CPU type and speed, Avalue's products model name, hardware & BIOS revision number, other hardware and software used, etc.) Note anything abnormal and list any on-screen messages you get when the problem occurs.
2. Call your dealer and describe the problem. Please have your manual, product, and any helpful information available.
3. If your product is diagnosed as defective, obtain an RMA (return material authorization) number from your dealer. This allows us to process your good return more quickly.
4. Carefully pack the defective product, a complete Repair and Replacement Order Card and a photocopy proof of purchase date (such as your sales receipt) in a shippable container. A product returned without proof of the purchase date is not eligible for warranty service.
5. Write the RMA number visibly on the outside of the package and ship it prepaid to your dealer.

CONTENT

1. Getting Started	8
1.1 Safety Precautions	8
1.2 Packing List	8
1.3 Document Amendment History	9
1.4 Manual Objectives	10
1.5 System Specifications	11
1.6 Architecture Overview – Block Diagram	12
2. Hardware Configuration	13
2.1 Product Overview	14
2.2 Installation Procedure	16
2.2.1 Main Memory	17
2.3 Jumper and Connector List	19
2.4 Setting Jumpers & Connectors	21
2.4.1 Clear CMOS (JBAT1)	21
2.4.2 COM 1 pin 9 signal select (JRI1)	21
2.4.3 AT/ ATX Input power select (JAT1)	22
2.4.4 LCD backlight brightness adjustment (JVR1)	22
2.4.5 5VSB connector in ATX (PWR_SB1)	23
2.4.6 Battery connector (BT1)	23
2.4.7 CPU fan connector (CPU_FAN1)	24
2.4.8 System fan connector (SYS_FAN1)	24
2.4.9 COM 1 RS-422-485 mode (RS422_1)	25
2.4.10 LCD inverter connector (JBKL1)	25
2.4.11 Audio connector (JAUDIO1)	26
2.4.11.1 Signal Description – Audio connector (JAUDIO1)	26
2.4.12 Low pin count connector (JLPC1)	27
2.4.13 Serial port 2 connector (COM2)	27
2.4.14 General purpose I/O connector (JDIO1)	28
2.4.15 Miscellaneous setting connector (JFP1)	28
2.4.16 SPI connector (JSPI1)	29
2.4.17 Power connector (PWR1)	29
2.4.18 SATA power connector (SATA_PWR1)	30
2.4.19 EC Debug connector (CN2)	30
2.4.20 LVDS connector (JLVDS1)	31
2.4.21 On-board box header for USB3.0 (JUSB3/4)	32
2.4.22 On-board box header for USB3.0 (JUSB5/6)	32

ECM-QM87R/ ECM-QM87

2.4.23	On-board box header for USB2.0 (JUSB7/8)	33
2.4.24	PS/2 keyboard & mouse connector (JKB/ MS1)	33
2.5	Audio / USB Daughter Board User's Guide	34
2.5.1	Jumper and Connector Layout	34
2.5.2	Jumper and Connector List	34
2.5.3	Setting Jumper and Connector.....	35
3.	BIOS Setup	36
3.1	Introduction.....	37
3.2	Starting Setup.....	37
3.3	Using Setup	38
3.4	Getting Help.....	39
3.5	In Case of Problems	39
3.6	BIOS setup	40
3.6.1	Main Menu.....	40
3.6.1.1	System Language.....	41
3.6.1.2	System Date	41
3.6.1.3	System Time.....	41
3.6.2	Advanced Menu.....	41
3.6.2.1	APCI Settings	42
3.6.2.2	S5 RTC Wake Settings.....	43
3.6.2.3	CPU Configuration.....	43
3.6.2.4	SATA Configuration	45
3.6.2.5	Intel(R) Rapid Start Technology	46
3.6.2.6	PCH-FW Configuration.....	47
3.6.2.6.1	Firmware Update Configuration.....	47
3.6.2.7	AMT Configuration.....	48
3.6.2.8	USB Configuration	49
3.6.2.9	Hardware Monitor	50
3.6.2.10	Super IO Configuration.....	51
3.6.2.10.1	Serial Port 1 Configuration	51
3.6.2.10.2	Serial Port 2 Configuration	52
3.6.2.11	Network Stack.....	53
3.6.2.12	Intel RC Drivers Version Detail.....	54
3.6.3	Chipset.....	54
3.6.3.1	PCH-IO Configuration.....	55
3.6.3.1.1	PCI Express Configuration	55
3.6.3.1.1.1	PCI Express Root Port 1	56
3.6.3.1.2	USB Configuration	57
3.6.3.1.3	PCH Azalia Configuration	57
3.6.3.2	System Agent (SA) Configuration	58

3.6.3.2.1	Graphics Configuration	58
3.6.3.2.1.1	LCD Control	59
3.6.3.2.2	Memory Configuration.....	61
3.6.4	Boot.....	61
3.6.4.1	CSM parameters.....	62
3.6.5	Security	63
3.6.6	Save and exit	64
3.6.6.1	Save Changes and Exit	64
3.6.6.2	Discard Changes and Reset	64
4.	Drivers Installation.....	65
4.1	Install Chipset Driver (For Intel QM87)	66
4.2	Install ME Driver (For Intel QM87)	67
4.3	Install USB 3.0 Driver (For Intel QM87)	68
4.4	Install VGA Driver (For Intel QM87).....	69
4.5	Install Audio Driver (For Realtek ALC892).....	70
4.6	Install Ethernet Driver (For Intel I217LM and I210AT)	71
5.	Mechanical Drawing	72

1. Getting Started

1.1 Safety Precautions

Warning!



Always completely disconnect the power cord from your chassis whenever you work with the hardware. Do not make connections while the power is on. Sensitive electronic components can be damaged by sudden power surges. Only experienced electronics personnel should open the PC chassis.

Caution!



Always ground yourself to remove any static charge before touching the CPU card. Modern electronic devices are very sensitive to static electric charges. As a safety precaution, use a grounding wrist strap at all times. Place all electronic components in a static-dissipative surface or static-shielded bag when they are not in the chassis.

1.2 Packing List

Before you begin installing your single board, please make sure that the following materials have been shipped:

- 1 x 3.5" ECM-QM87R/ ECM-QM87 Micro Module
- 1 x AUX-056 daughter board
- 1 x DVD-ROM contains the followings:
 - User's Manual (this manual in PDF file)
 - Ethernet driver and utilities
 - VGA drivers and utilities
 - Audio drivers and utilities
- 1 x Cable set contains the followings:
 - 1 x Audio cable (12pin,2.0 pitch)
 - 1 x USB 2.0 cable (10P/2.0mm-10P/2.0mm)
 - 1 x USB 3.0 cable ((20P/2.0mm-20P/2.0mm)
 - 1 x Serial ATA cable (7-pin, standard)
 - 1 x Wire SATA power cable (15-pin,4P/2.5mm)
 - 1 x Flat cable 9P(M)-PHD 10P/2.0mm)
- 3M foam (VHB-4622 10mm*20mm*1.1mm)

1.3 Document Amendment History

Revision	Date	Comment
1 st	December 2014	Initial Release

1.4 Manual Objectives

This manual describes in detail the Avalue Technology ECM-QM87R/ ECM-QM87 Single Board.

We have tried to include as much information as possible but we have not duplicated information that is provided in the standard IBM Technical References, unless it proved to be necessary to aid in the understanding of this board.

We strongly recommend that you study this manual carefully before attempting to interface with ECM-QM87R/ ECM-QM87 series or change the standard configurations. Whilst all the necessary information is available in this manual we would recommend that unless you are confident, you contact your supplier for guidance.

Please be aware that it is possible to create configurations within the CMOS RAM that make booting impossible. If this should happen, clear the CMOS settings, (see the description of the Jumper Settings for details).

If you have any suggestions or find any errors concerning this manual and want to inform us of these, please contact our Customer Service department with the relevant details.

1.5 System Specifications

System	
CPU	Intel® Haswell Processor
BIOS	AMI uEFI BIOS, 128 Mbit SPI Flash ROM
System Chipset	Intel® QM87
I/O Chip	EC(IT8518E)
System Memory	One 204-pin DDR3L SODIMM Socket Supports Up to 8GB DDR3L 1333/ 1600 SDRAM
Watchdog Timer	H/W Reset, 1sec. – 65535sec./min. 1sec. or 1min. step
H/W Status Monitor	CPU & system temperature monitoring Voltages monitoring
Expansion	1 x mini-PCIe (mSATA supported)
Display	
Chipset	Intel® QM87
Resolution	VGA Mode: 1920 x 1200 @ 60Hz HDMI Mode: 1920 x 1200 @ 60Hz LVDS Mode: 1920 x 1080 @ 60Hz
Audio	
Chipset	Realtek ALC892 HD codec
Audio Interface	Mic-in, Line-in, Line-out
Mechanical & Environmental	
Power Requirement	+12V
Power Type	AT/ATX
ACPI	Single power ATX Support S0, S1, S3, S4, S5 ACPI 3.0 Compliant
Operating Temp.	0°C ~ 60°C
Storage Temp.	-40°C ~ 75°C
Operating Humidity	0%~90% relative humidity, non-condensing
Size (L x W)	5.7" x 4" (146mm x 101mm)
Weight	0.44lbs (0.2kg)

1.6 Architecture Overview – Block Diagram

The following block diagram shows the architecture and main components of ECM-QM87R/ ECM-QM87.

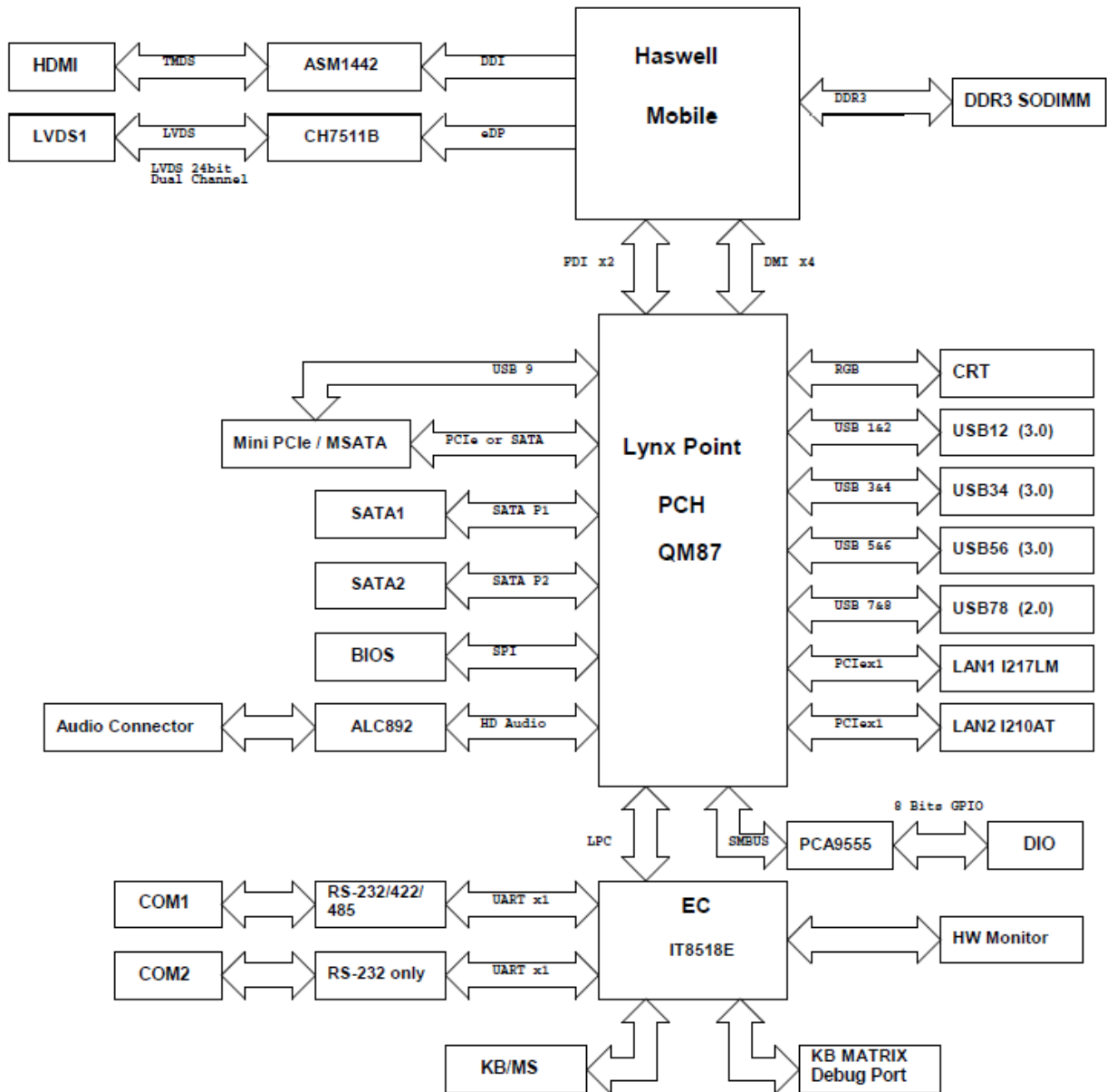

2. Hardware Configuration

2.1 Product Overview

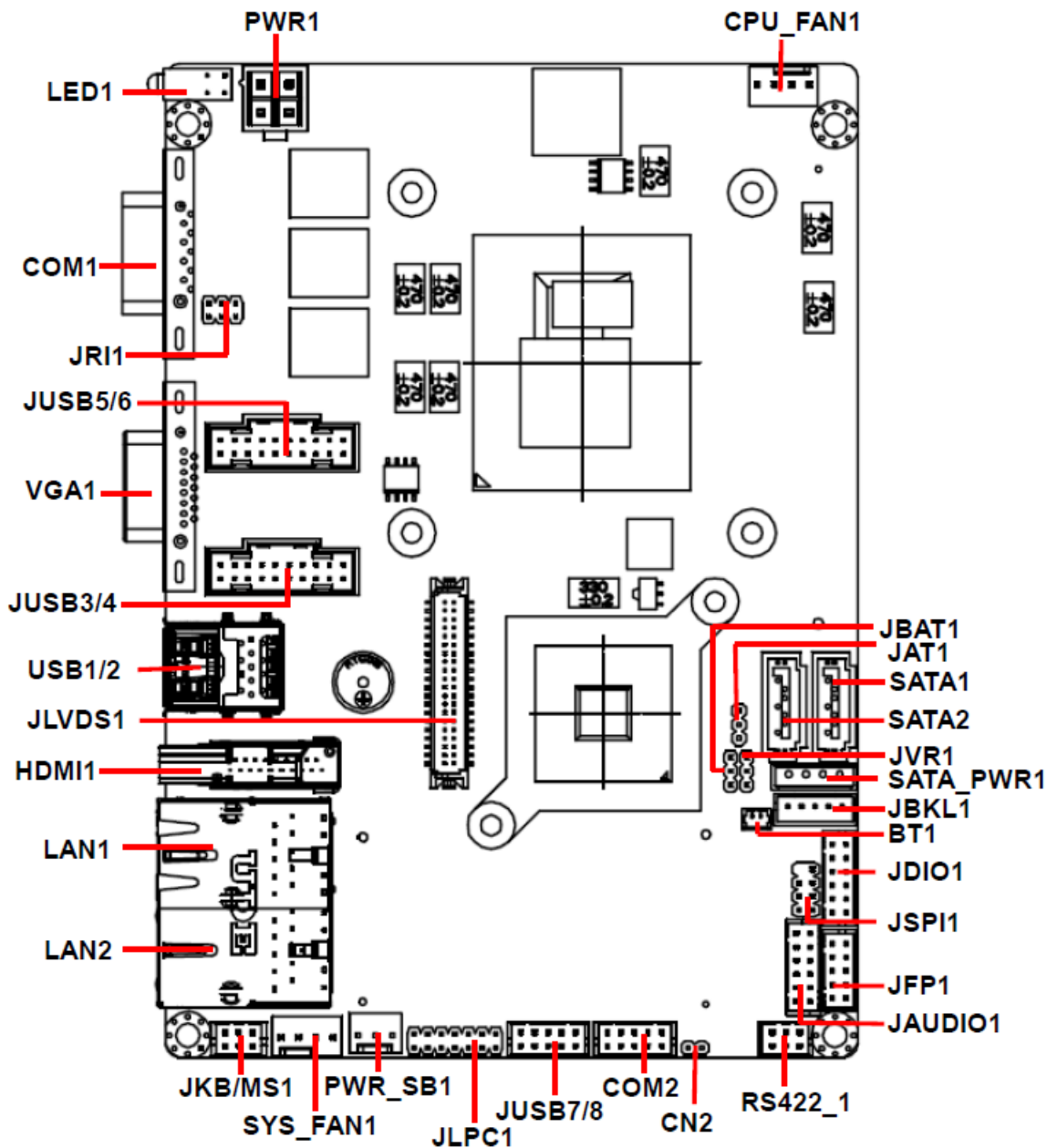

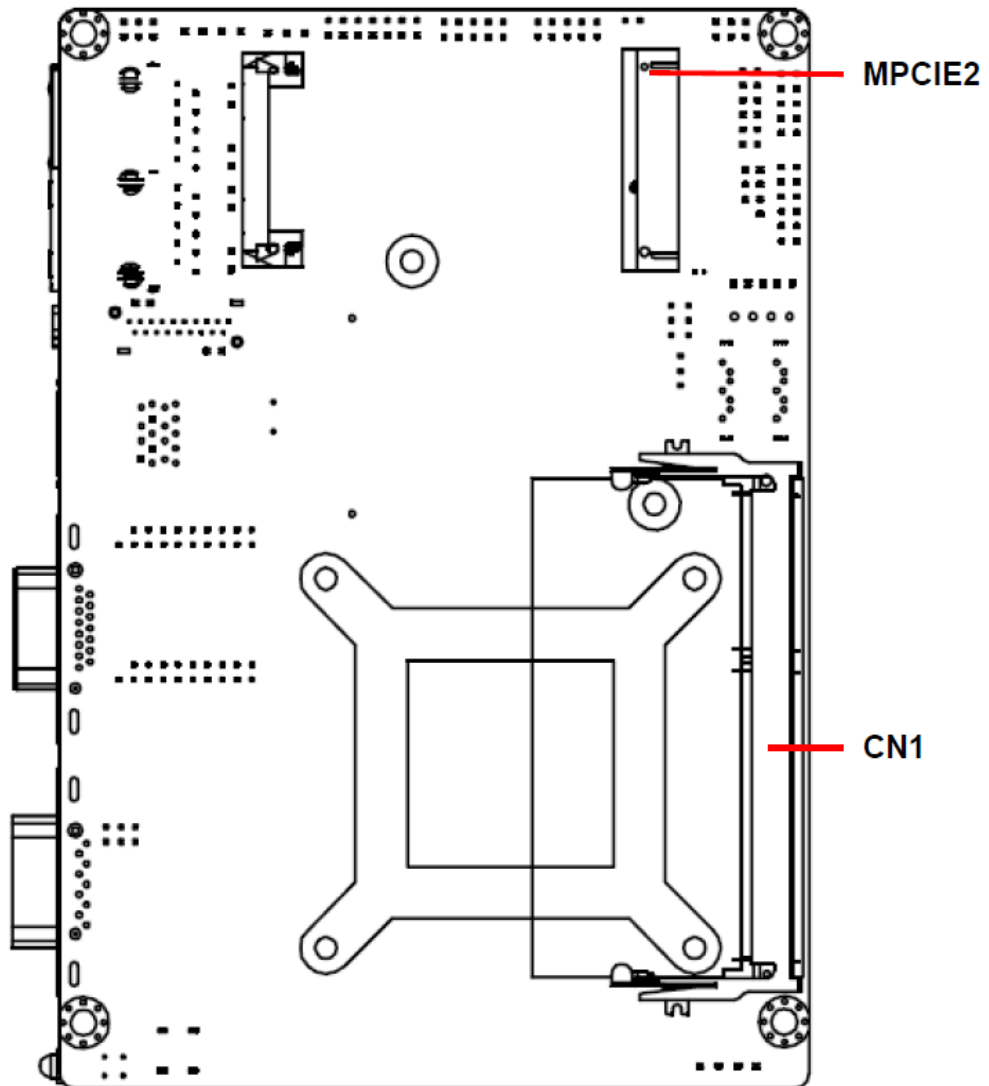

2.2 Installation Procedure

This chapter explains you the instructions of how to setup your system.

1. Turn off the power supply.
2. Insert the SODIMM module (be careful with the orientation).
3. Insert all external cables for hard disk, floppy, keyboard, mouse, USB etc. except for flat panel. A CRT monitor must be connected in order to change CMOS settings to support flat panel.
4. Connect power supply to the board via the ATXPWR.
5. Turn on the power.
6. Enter the BIOS setup by pressing the delete key during boot up. Use the “LOAD BIOS DEFAULTS” feature. The **Integrated Peripheral Setup** and the **Standard CMOS Setup** Window must be entered and configured correctly to match the particular system configuration.
7. If TFT panel display is to be utilized, make sure the panel voltage is correctly set before connecting the display cable and turning on the power.



Note: Make sure the heat sink and the CPU top surface are in total contact to avoid CPU overheating problem that would cause the system to hang or unstable

2.2.1 Main Memory

ECM-QM87R/ ECM-QM87 provides one 204-pin DDR3L SODIMM socket, supports up to 8GB DDR3L 1333/1600 SDRAM.

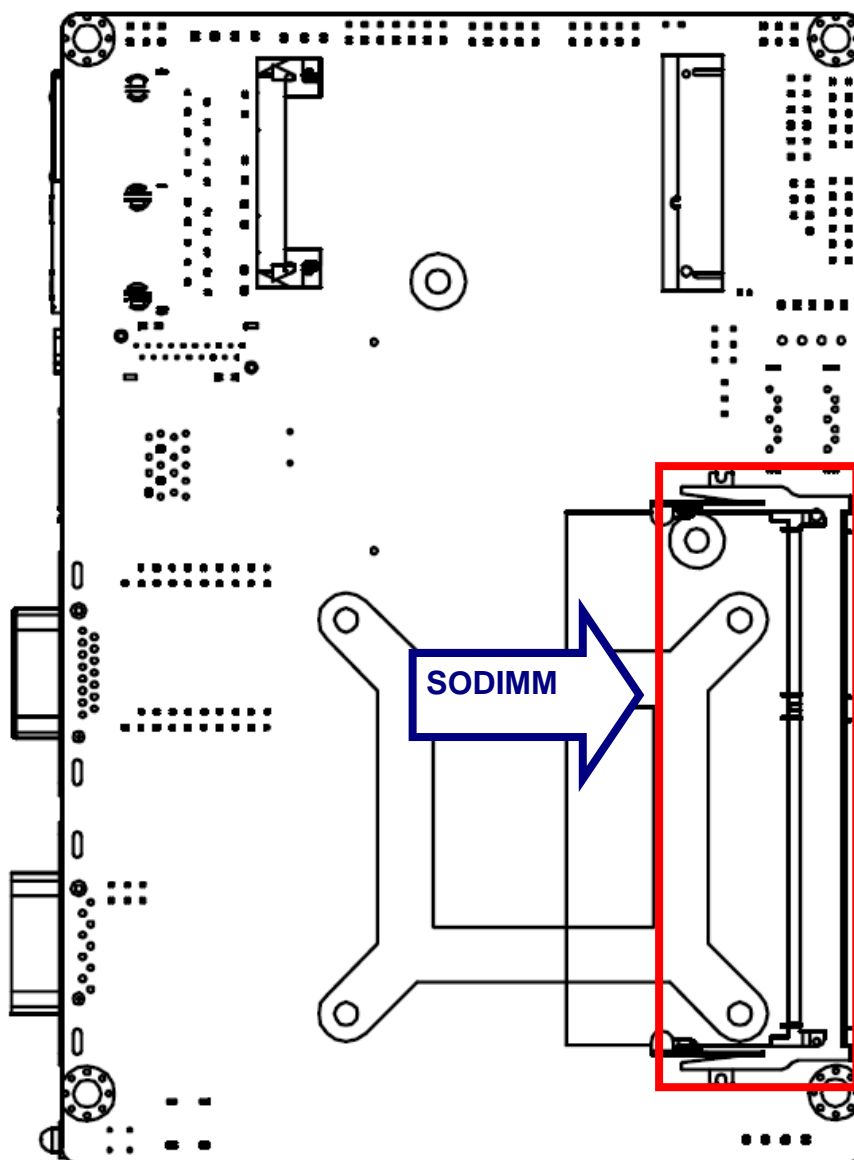

(Rear side)



Make sure to unplug the power supply before adding or removing SODIMMs or other system components. Failure to do so may cause severe damage to both the board and the components.

- Locate the SODIMM socket on the board.
- Hold two edges of the SODIMM module carefully. Keep away of touching its connectors.
- Align the notch key on the module with the rib on the slot.

ECM-QM87R/ ECM-QM87

- Firmly press the modules into the socket automatically snaps into the mounting notch. Do not force the SODIMM module in with extra force as the SODIMM module only fit in one direction.

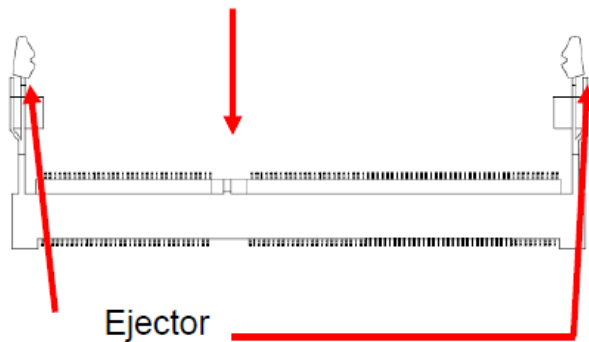
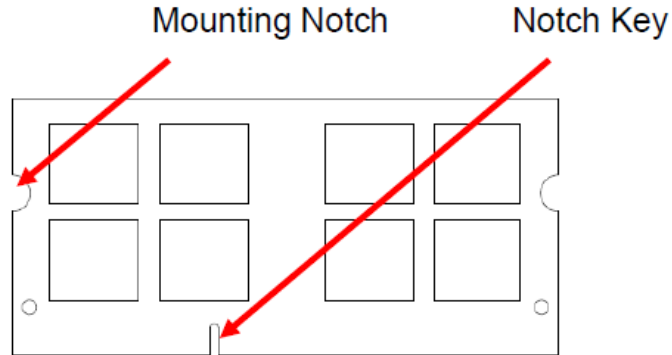

204-pin DDR3 SODIMM

- To remove the SODIMM modules, push the two ejector tabs on the slot outward simultaneously, and then pull out the SODIMM module.



Note:

- (1) Please do not change any DDR3 SDRAM parameter in BIOS setup to increase your system's performance without acquiring technical information in advance.
- (2) Static electricity can damage the electronic components of the computer or optional boards. Before starting these procedures, ensure that you are discharged of static electricity by touching a grounded metal object briefly.

2.3 Jumper and Connector List

You can configure your board to match the needs of your application by setting jumpers. A jumper is the simplest kind of electric switch.

It consists of two metal pins and a small metal clip (often protected by a plastic cover) that slides over the pins to connect them. To “close” a jumper you connect the pins with the clip. To “open” a jumper you remove the clip. Sometimes a jumper will have three pins, labeled 1, 2, and 3. In this case, you would connect either two pins.

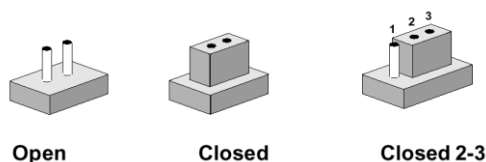

The jumper settings are schematically depicted in this manual as follows:



A pair of needle-nose pliers may be helpful when working with jumpers.

Connectors on the board are linked to external devices such as hard disk drives, a keyboard, or floppy drives. In addition, the board has a number of jumpers that allow you to configure your system to suit your application.

If you have any doubts about the best hardware configuration for your application, contact your local distributor or sales representative before you make any changes.

The following tables list the function of each of the board's jumpers and connectors.

Jumpers

Label	Function	Note
JBAT1	Clear CMOS	3 x 1 header, pitch 2.00 mm
JRI1	COM 1 pin 9 signal select	3 x 2 header, pitch 2.00 mm
JAT1	AT/ ATX Input power select	3 x 1 header, pitch 2.00 mm
JVR1	LCD backlight brightness adjustment	3 x 1 header, pitch 2.00 mm

Connectors

Label	Function	Note
BT1	Battery connector	2 x 1 wafer, pitch 1.25 mm
CPU_FAN1	CPU fan connector	4 x 1 wafer, pitch 2.54 mm
HDMI1	HDMI connector	
RS422_1	COM 1 RS-422-485 mode	3 x 2 wafer, pitch 2.00 mm
JAUDIO1	Audio connector	6 x 2 wafer, pitch 2.00 mm
JBKL1	LCD inverter connector	5 x 1 wafer, pitch 2.00 mm
COM1	Serial port 1 connector	D-sub 9-pin, male
COM2	Serial port 2 connector	5 x 2 wafer, pitch 2.00 mm
JDIO1	General purpose I/O connector	6 x 2 wafer, pitch 2.00 mm
JFP1	Miscellaneous setting connector	5 x 2 wafer, pitch 2.00 mm
JLPC1	Low pin count interface	7 x 2 header, pitch 2.00 mm
JLVDS1	LVDS connector	20 x 2 header, pitch 1.25 mm
JSPI1	SPI connector	4 x 2 header, pitch 2.00 mm
USB1/2	On-board connector for USB3.0	
JUSB3/4	On-board box header for USB3.0	10 x 2 wafer, pitch 2.00 mm
JUSB5/6	On-board box header for USB3.0	10 x 2 wafer, pitch 2.00 mm
JUSB7/8	On-board box header for USB2.0	5 x 2 wafer, pitch 2.00 mm
CN2	EC Debug connector	2 x 1 header, pitch 2.00 mm
LAN1/LAN2	RJ-45 Ethernet connector	
LED1	LED connector	
PWR_SB1	5VSB connector in ATX	3 x 1 wafer, pitch 2.54 mm
PWR1	Power connector	2 x 2 wafer, pitch 4.20 mm
JKB/MS1	PS/2 keyboard & mouse connector	2 x 3 wafer, pitch 2.00 mm
SATA_PWR1	SATA power connector	1 x 4 wafer, pitch 2.50 mm
SATA1	Serial ATA connector 1	
SATA2	Serial ATA connector 2	
SYS_FAN1	System fan connector	4 x 1 wafer, pitch 2.54 mm
VGA1	VGA connector	D-sub 15-pin, female
MPCIE2	Mini-PCI connector	
CN1	DDR3 SODIMM connector	

2.4 Setting Jumpers & Connectors

2.4.1 Clear CMOS (JBAT1)

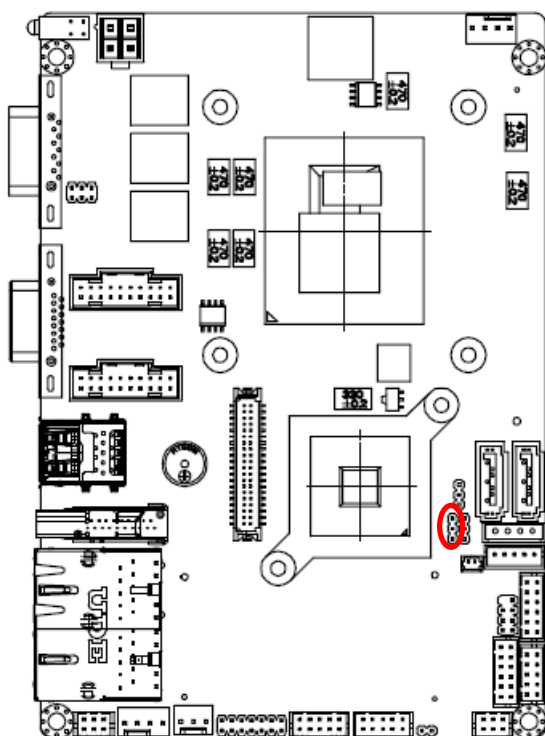

Protect*

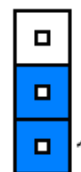

Clear CMOS

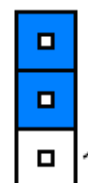

* Default

2.4.2 COM 1 pin 9 signal select (JRI1)

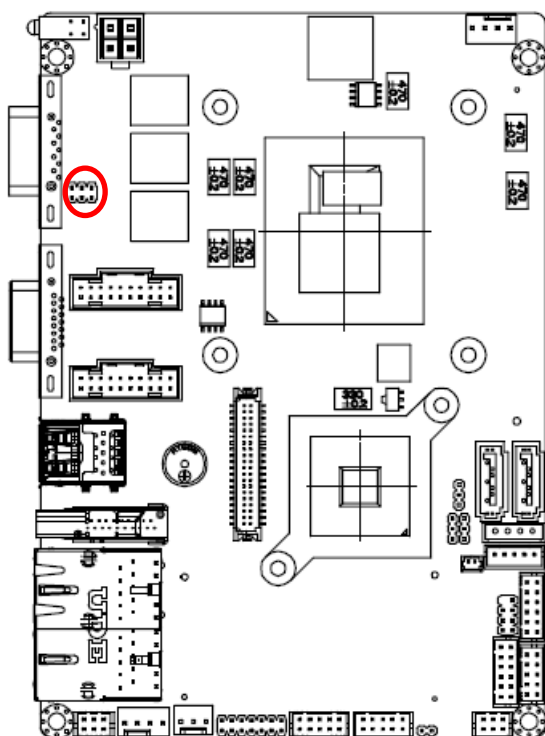

Ring*

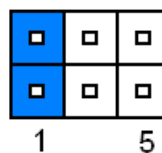

+5V

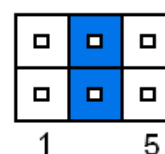

+12V

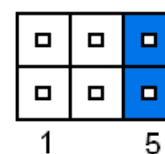

* Default

ECM-QM87R/ ECM-QM87

2.4.3 AT/ ATX Input power select (JAT1)

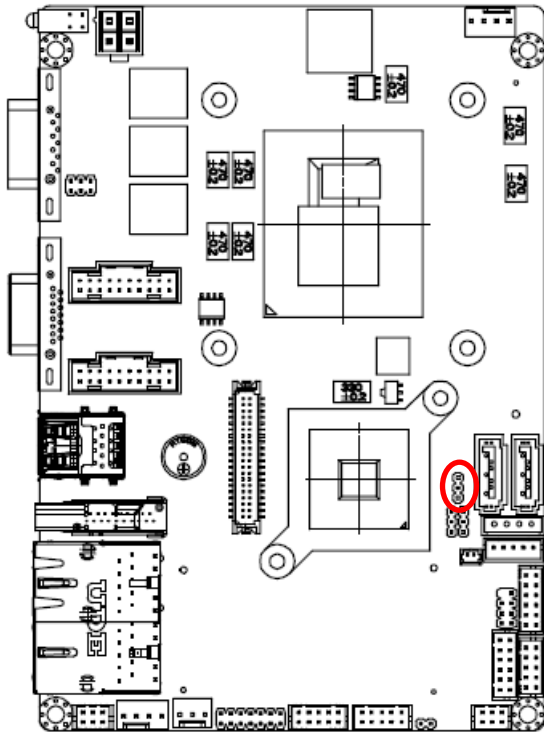

AT*

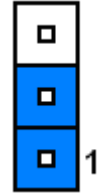

ATX

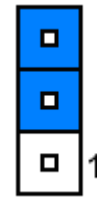

* Default

2.4.4 LCD backlight brightness adjustment (JVR1)

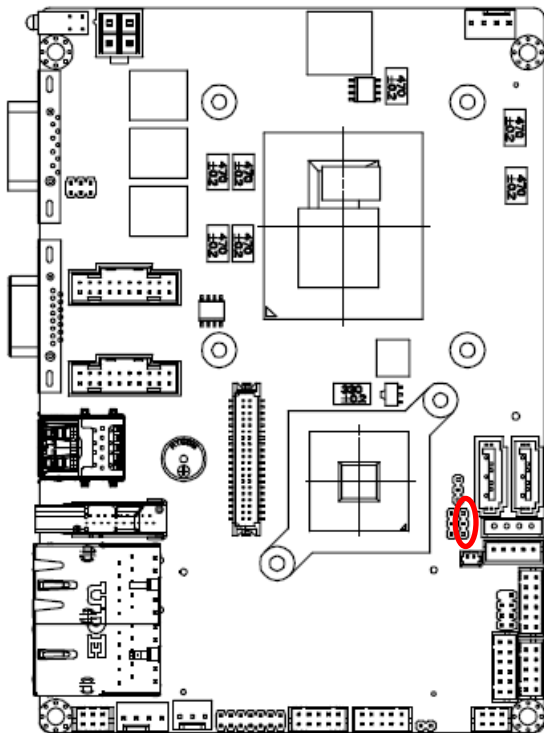

PWM Mode*

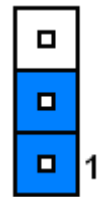

DC Mode

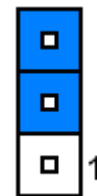

* Default

2.4.5 5VSB connector in ATX (PWR_SB1)

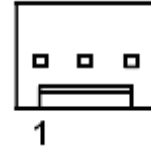
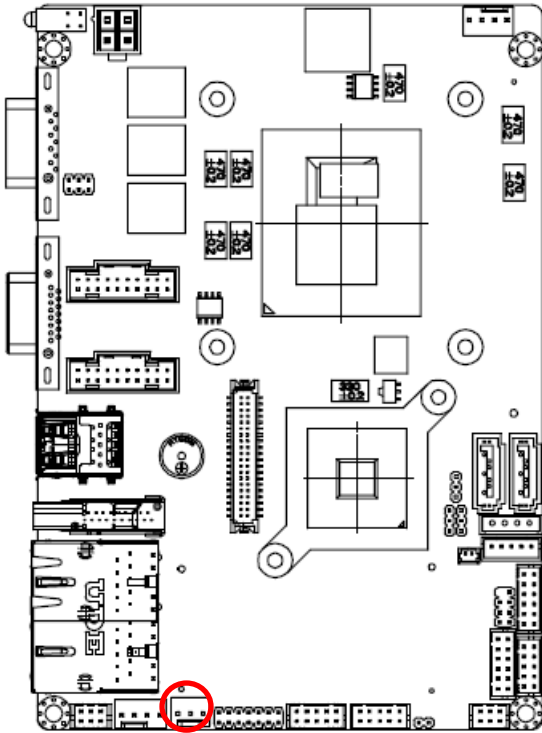

Signal	PIN
PSON_ATX#	1
GND	2
+ATX5VSB	3

2.4.6 Battery connector (BT1)

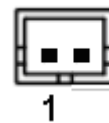
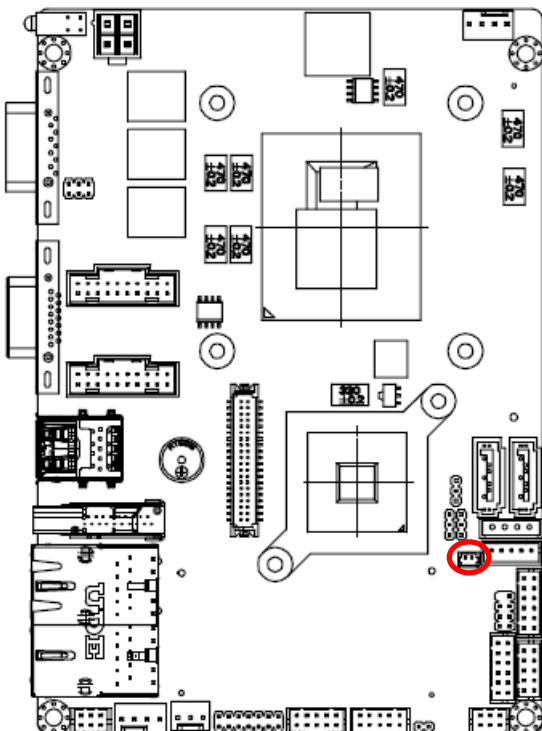

Signal	PIN
+3.3V	1
GND	2

2.4.7 CPU fan connector (CPU_FAN1)

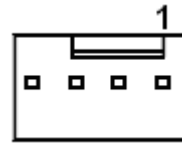
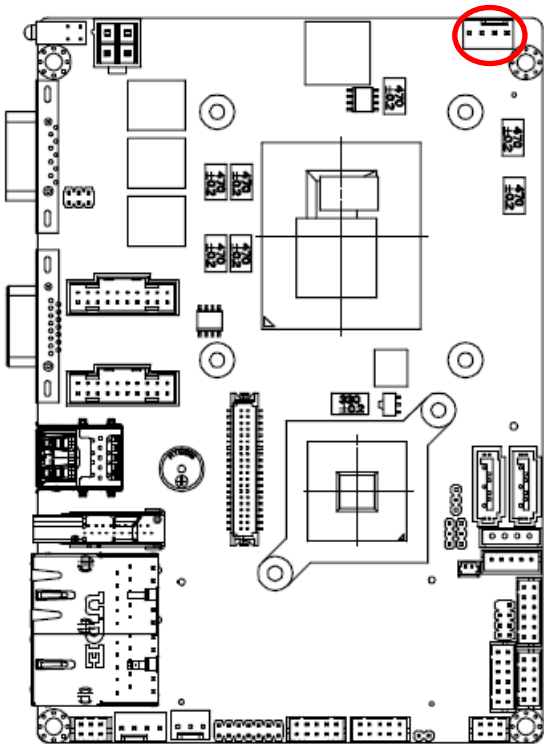

Signal	PIN
GND	1
+12V	2
Tachometer0	3
FAN_PWM0	4

2.4.8 System fan connector (SYS_FAN1)

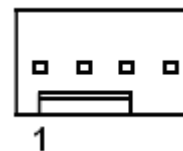
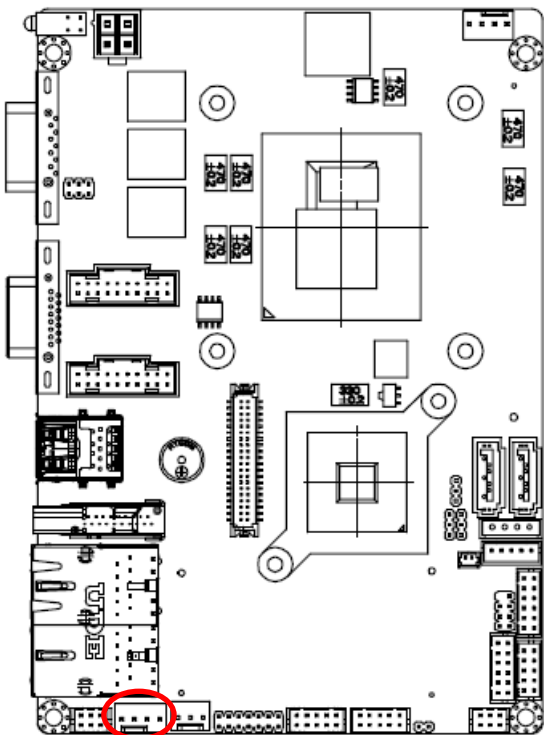

Signal	PIN
GND	1
+12V	2
Tachometer1	3
FAN_PWM1	4

2.4.9 COM 1 RS-422-485 mode (RS422_1)

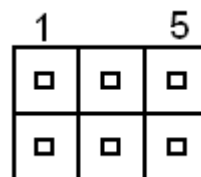
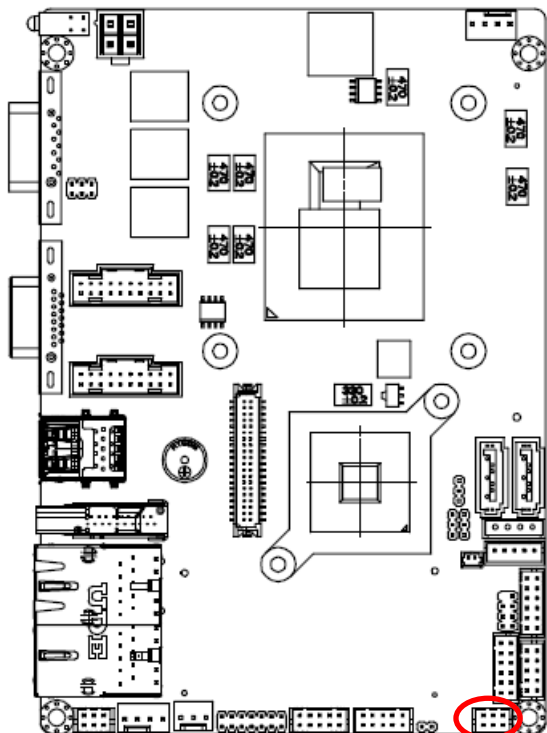

Signal	PIN	PIN	Signal
485_422TX1-	2	1	422RX1-
485_422TX1+	4	3	422RX1+
+5V	6	5	GND

Note:

J422/485 is available after modify the mode of COM1 in BIOS setting

2.4.10 LCD inverter connector (JBKL1)

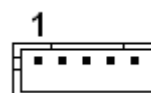
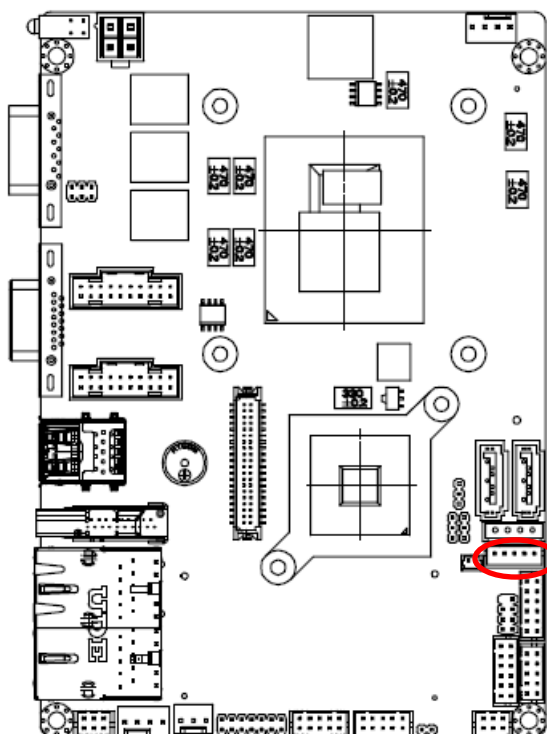

Signal	PIN
+12V	1
GND	2
BKLEN	3
VBRIGHT	4
+5V	5

ECM-QM87R/ ECM-QM87

2.4.11 Audio connector (JAUDIO1)

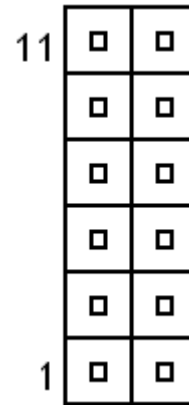
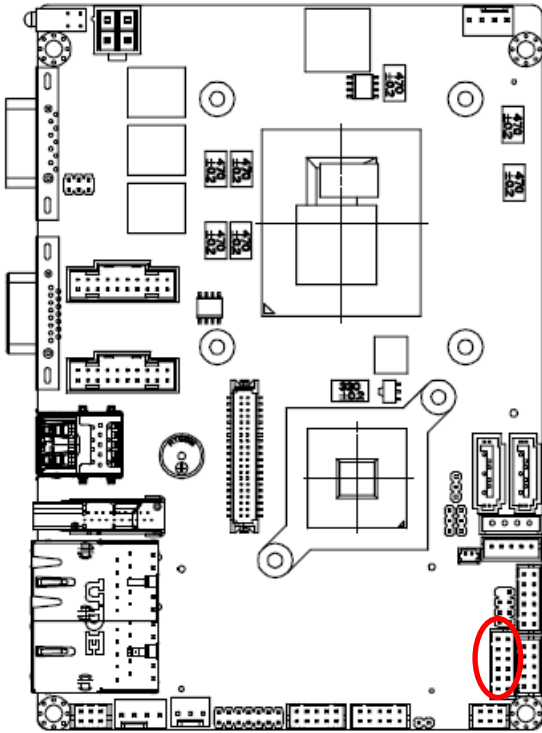

Signal	PIN	PIN	Signal
GND	11	12	MIC1-JD
LINE1-JD	9	10	FRONT-JD
MIC1-L-IN	7	8	MIC1-R-IN
LINE1-L-IN	5	6	LINE1-R-IN
GND	3	4	GND
FRONT-L-OUT	1	2	FRONT-R-OUT

2.4.11.1 Signal Description – Audio connector (JAUDIO1)

Signal	Signal Description
LINE1_JD	AUDIO IN (LINE_RIN/LIN)sense pin
FRONT_JD	AUDIO Out(ROUT/LOUT) sense pin
MIC1_JD	MIC IN (MIC_RIN/LIN) sense pin

2.4.12 Low pin count connector (JLPC1)

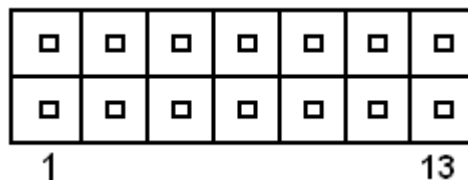
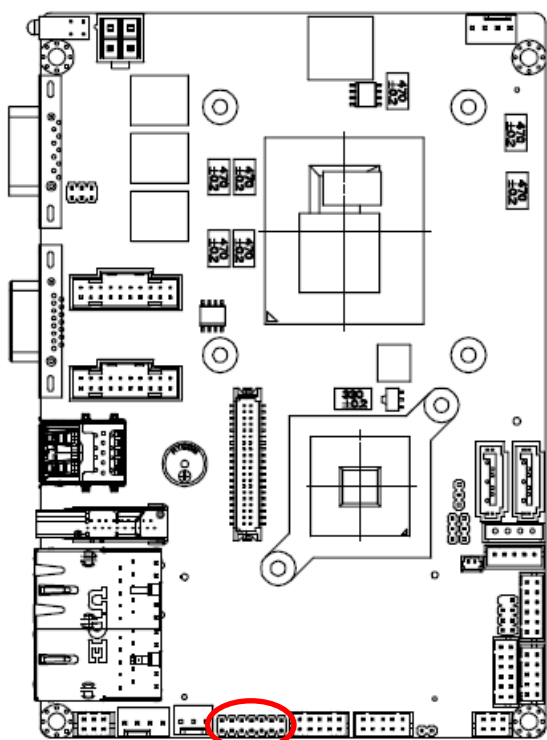

Signal	PIN	PIN	Signal
LPC_AD0	1	2	+3.3V
LPC_AD1	3	4	LPC_RESET#
LPC_AD2	5	6	LPC_LFRAME#
LPC_AD3	7	8	CLK_PCI_LPC
SERIRQ	9	10	GND
+V5S	11	12	GND
+V5A	13	14	LPC_LDRQ0#

2.4.13 Serial port 2 connector (COM2)

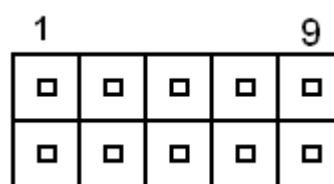
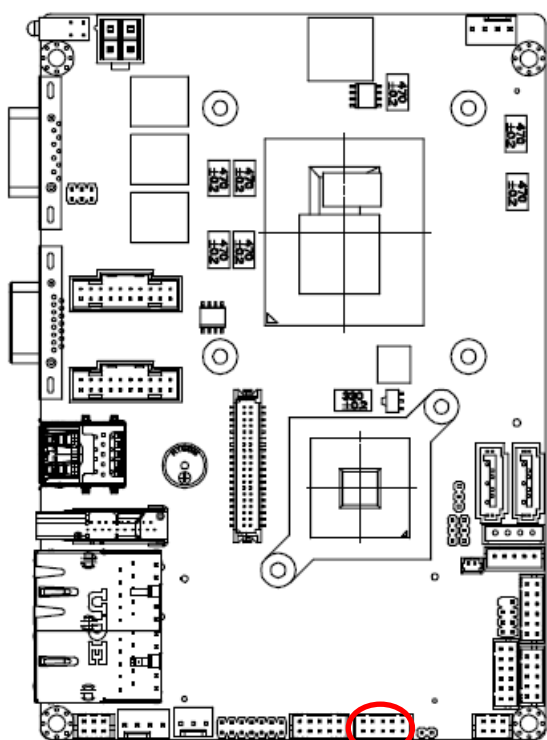

Signal	PIN	PIN	Signal
NDCDB#	1	2	NRXDB
NTXDB	3	4	NDTRB#
GND	5	6	NDSRB#
NRTSB#	7	8	NCTSB#
NRIB#	9	10	NC

ECM-QM87R/ ECM-QM87

2.4.14 General purpose I/O connector (JDIO1)

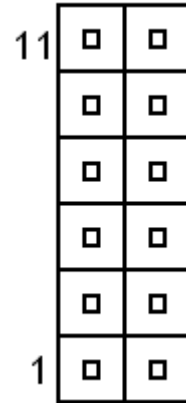
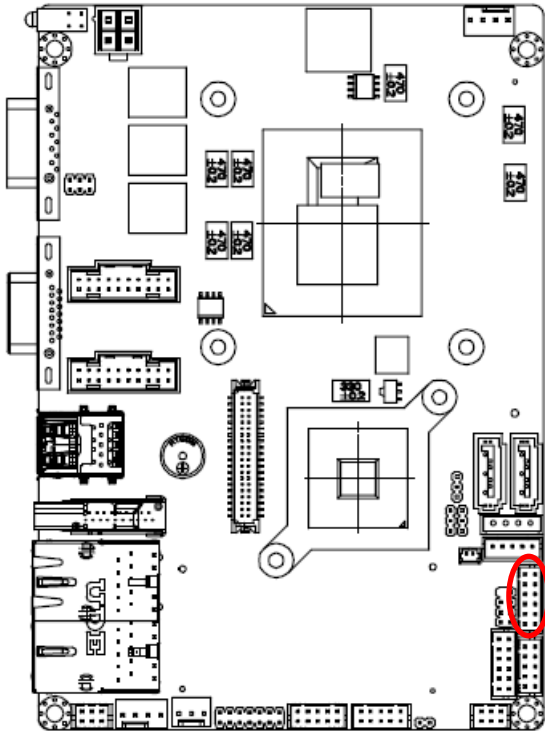

Signal	PIN	PIN	Signal
+5V	11	12	GND
SMB_DATA_9555	9	10	SMB_CLK_9555
DIO_GP13	7	8	DIO_GP23
DIO_GP12	5	6	DIO_GP22
DIO_GP11	3	4	DIO_GP21
DIO_GP10	1	2	DIO_GP20

2.4.15 Miscellaneous setting connector (JFP1)

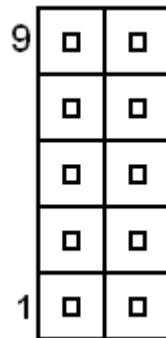
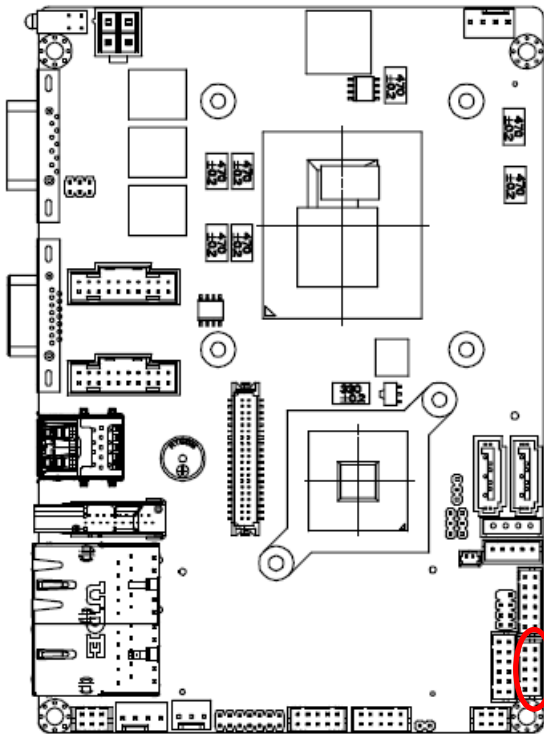

Signal	PIN
PWBT	1
	2
RST#	3
	4
PWR-LED-	5
PWR-LED+	6
HDD-LED+	7
HDD-LED-	8
COPEN#	9
	10

2.4.16 SPI connector (JSPI1)

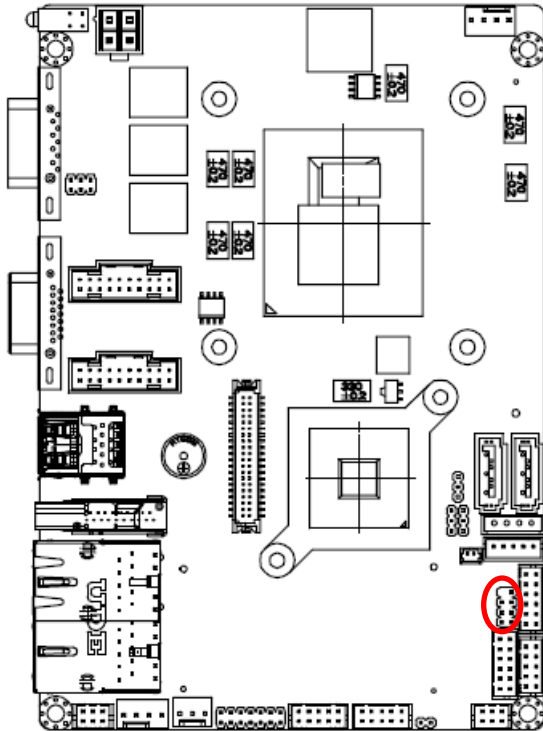

Signal	PIN	PIN	Signal
		7	HOLD#
SPI_SI	6	5	SPI_SO
SPI_CLK	4	3	SPI_CS0#
GND	2	1	+3.3V

2.4.17 Power connector (PWR1)

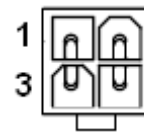
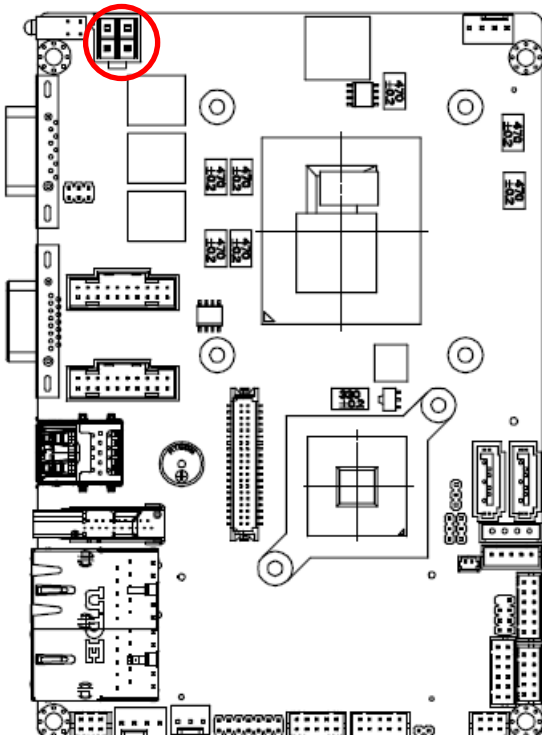

Signal	PIN	PIN	Signal
GND	1	2	GND
+12V	3	4	+12V

ECM-QM87R/ ECM-QM87

2.4.18 SATA power connector (SATA_PWR1)

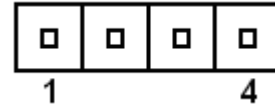
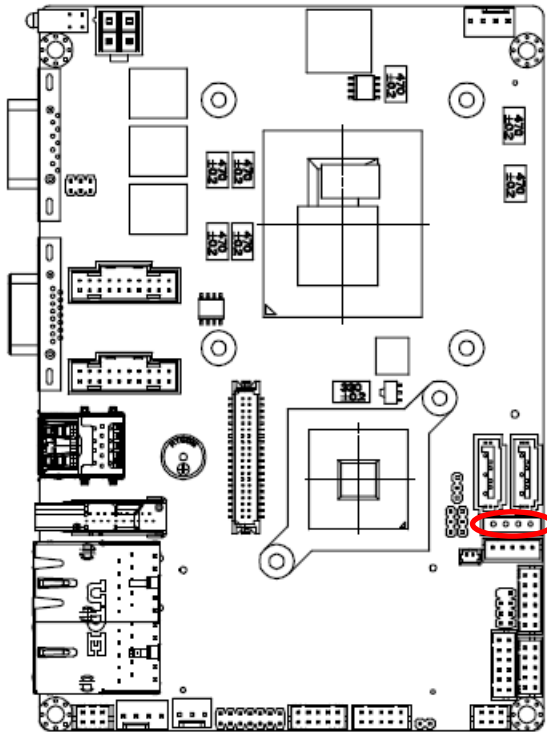

Signal	PIN
GND	1
GND	2
+5V	3
+5V	4

2.4.19 EC Debug connector (CN2)

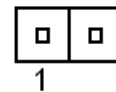
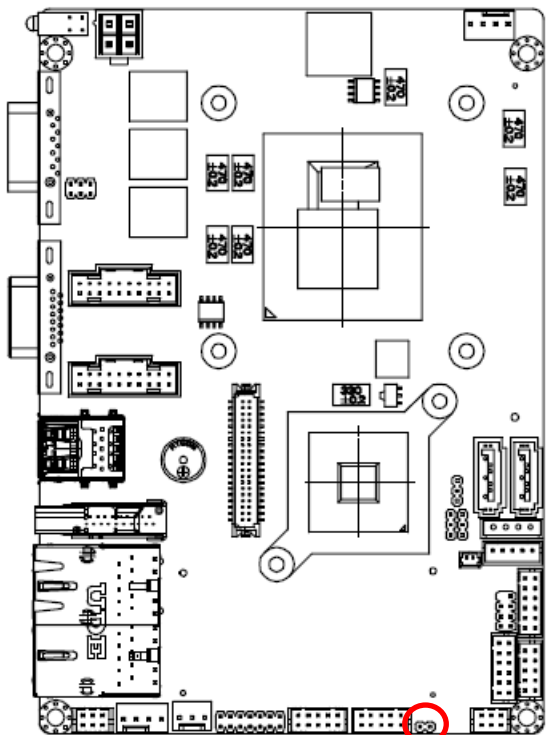

Signal	PIN
EC_SMCLK_DEBUG	1
EC_SMDAT_DEBUG	2

2.4.20 LVDS connector (JLVDS1)

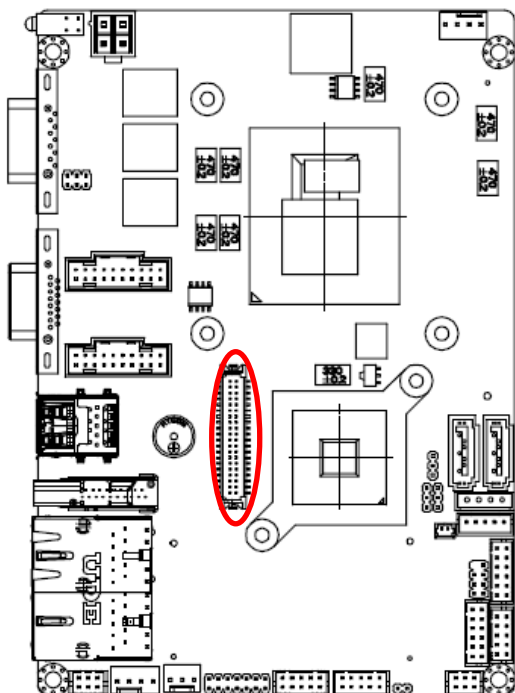

Signal	PIN	PIN	Signal
+12V	39	40	+12V
GND	37	38	GND
LVDS_CLK2_N	35	36	LVDS_CLK1_N
LVDS_CLK2_P	33	34	LVDS_CLK1_P
GND	31	32	GND
LVDS_DATA7_N	29	30	LVDS_DATA6_N
LVDS_DATA7_P	27	28	LVDS_DATA6_P
GND	25	26	GND
LVDS_DATA5_N	23	24	LVDS_DATA4_N
LVDS_DATA5_P	21	22	LVDS_DATA4_P
GND	19	20	GND
LVDS_DATA3_N	17	18	LVDS_DATA2_N
LVDS_DATA3_P	15	16	LVDS_DATA2_P
GND	13	14	GND
LVDS_DATA1_N	11	12	LVDS_DATA0_N
LVDS_DATA1_P	9	10	LVDS_DATA0_P
GND	7	8	GND
NC	5	6	NC
+3.3V	3	4	+5V
+3.3V	1	2	+5V

ECM-QM87R/ ECM-QM87

2.4.21 On-board box header for USB3.0 (JUSB3/4)

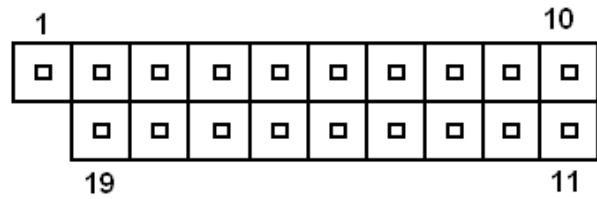
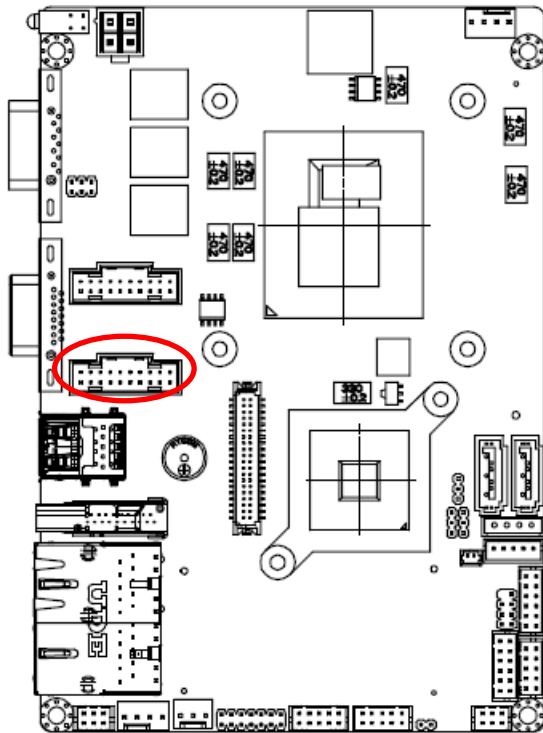

Signal	PIN	PIN	Signal
USBVCC2	1		
USB3_RXN3_L	2	19	USBVCC3
USB3_RXP3_L	3	18	USB3_RXN4_L
GND	4	17	USB3_RXP4_L
USB3_TXN3_L	5	16	GND
USB3_TXP3_L	6	15	USB3_TXN4_L
GND	7	14	USB3_TXP4_L
USB_PN_Z_4	8	13	GND
USB_PP_Z_4	9	12	USB_PN_Z_6
NC	10	11	USB_PP_Z_6

2.4.22 On-board box header for USB3.0 (JUSB5/6)

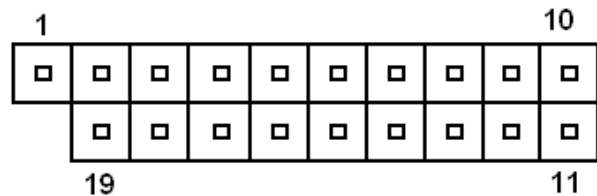
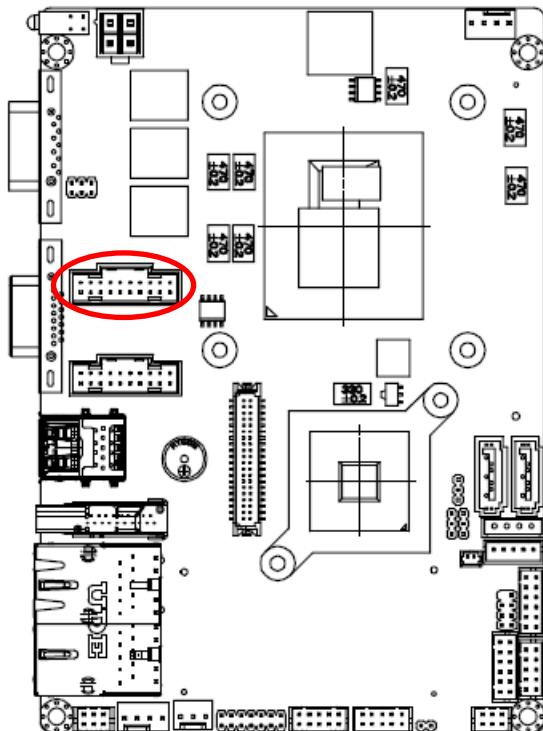

Signal	PIN	PIN	Signal
USBVCC4	1		
USB3_RXN5_L	2	19	USBVCC5
USB3_RXP5_L	3	18	USB3_RXN6_L
GND	4	17	USB3_RXP6_L
USB3_TXN5_L	5	16	GND
USB3_TXP5_L	6	15	USB3_TXN6_L
GND	7	14	USB3_TXP6_L
USB_PN_Z_8	8	13	GND
USB_PP_Z_8	9	12	USB_PN_Z_10
NC	10	11	USB_PP_Z_10

2.4.23 On-board box header for USB2.0 (JUSB7/8)

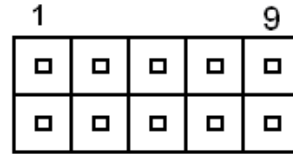
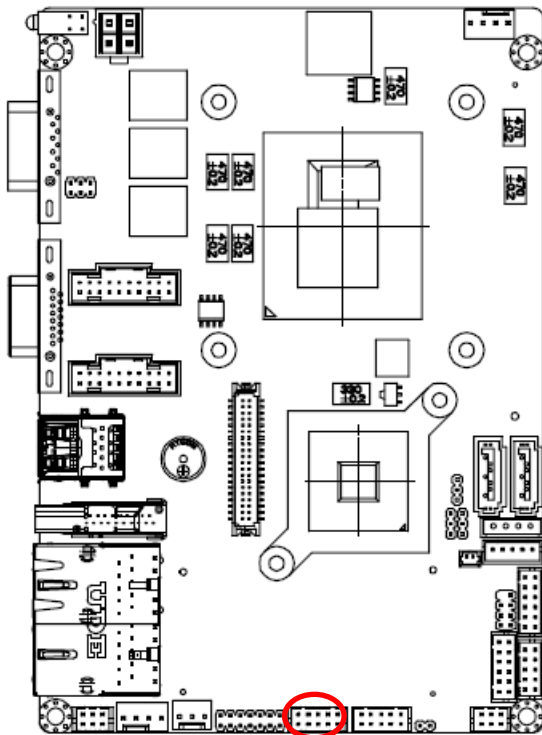

Signal	PIN	PIN	Signal
USBVCC6	1	2	USBVCC6
USB_PN_Z_12	3	4	USB_PN_Z_13
USB_PP_Z_12	5	6	USB_PP_Z_13
GND	7	8	GND
GND	9	10	GND

2.4.24 PS/2 keyboard & mouse connector (JKB/ MS1)

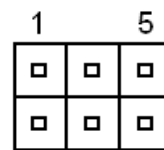
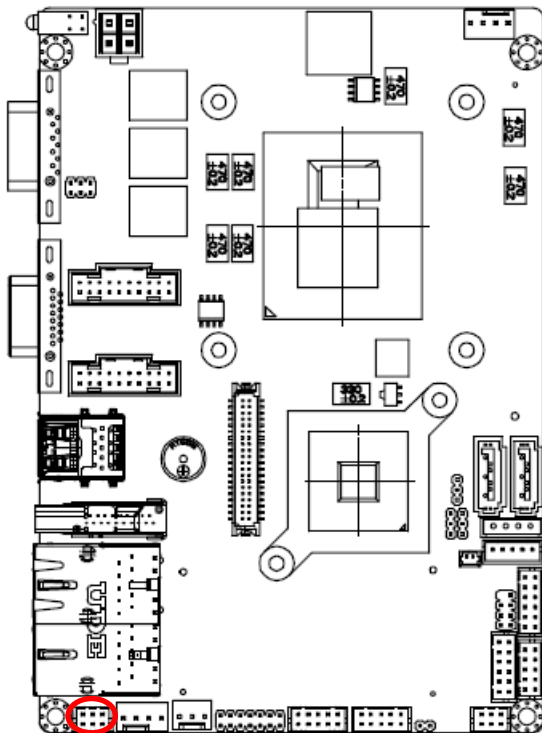

Signal	PIN	PIN	Signal
KBCK	1	2	KBDT
KBVCC	3	4	GND
MSCK	5	6	MSDT

2.5 Audio / USB Daughter Board User's Guide

2.5.1 Jumper and Connector Layout

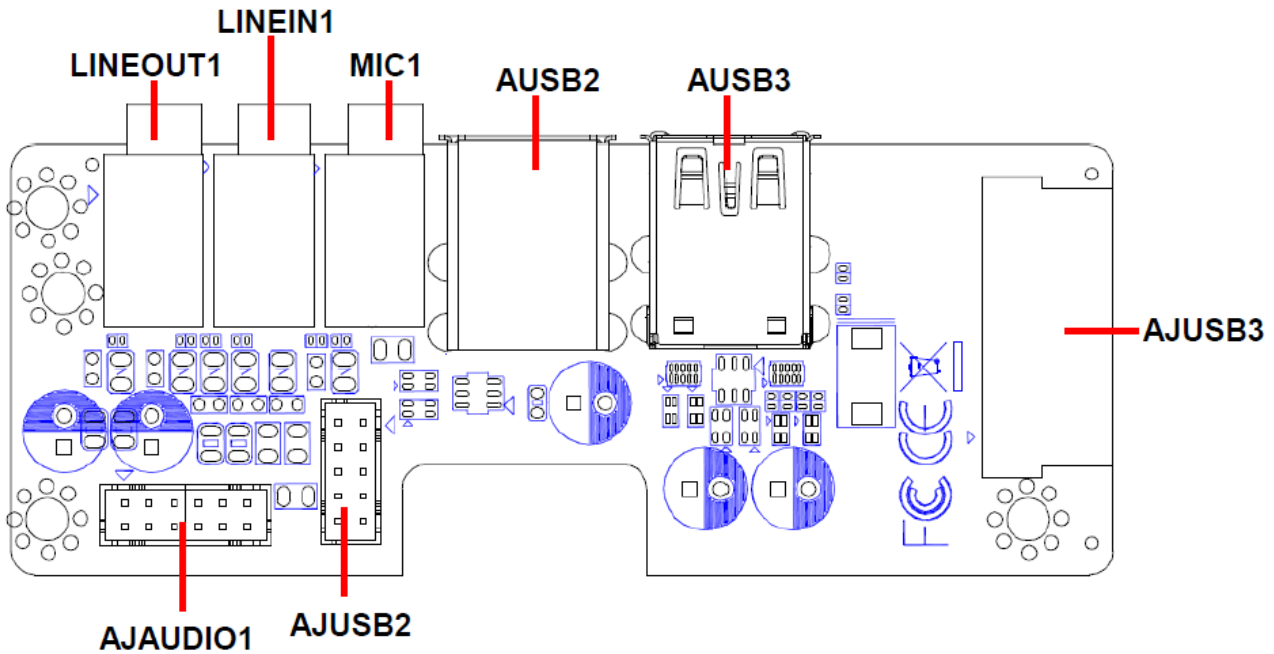

2.5.2 Jumper and Connector List

Connectors

Label	Function	Note
AUSB2	USB connector 2.0	
AUSB3	USB connector 3.0	
MIC1	Mic in connector	Phone Jack
LINEOUT1	Line out connector	Phone Jack
LINEIN1	Line in connector	Phone Jack
AJAUDIO1	Audio connector	6 x 2 header, pitch 2.00mm
AJUSB2	2.00mm USB connector	5 x 2 header, pitch 2.00mm
AJUSB3	2.00mm USB connector	10 x 2 header, pitch 2.00mm

2.5.3 Setting Jumper and Connector

Audio Connector (AJAUDIO1)

Signal	PIN	PIN	Signal
AFRONT1-L-OUT	1	2	AFRONT1-R-OUT
GND	3	4	GND
ALINE1-L-IN	5	6	ALINE1-R-IN
AMIC1-L-IN	7	8	AMIC1-R-IN
ALINE1-JD	9	10	AFRONT1-JD
GND	11	12	AMIC1-JD

2.00mm USB Connector (AJUSB2)

Signal	PIN	PIN	Signal
USB2VCC	1	2	USB2VCC
AUSB_PN2	3	4	AUSB_PN1
AUSB_PP2	5	6	AUSB_PP1
GND	7	8	GND
GND	9	10	GND

2.00mm USB Connector (AJUSB3)

Signal	PIN	PIN	Signal
AUSBVCC2	1		
AUSB3_RXN1_L	2	19	AUSBVCC3
AUSB3_RXP1_L	3	18	AUSB3_RXN2_L
GND	4	17	AUSB3_RXP2_L
AUSB3_TXN1_L	5	16	GND
AUSB3_TXP1_L	6	15	AUSB3_TXN2_L
GND	7	14	AUSB3_TXP2_L
AUSB_PN3	8	13	GND
AUSB_PP3	9	12	AUSB_PN4
NC	10	11	AUSB_PP4

3. BIOS Setup

3.1 Introduction

The BIOS setup program allows users to modify the basic system configuration. In this following chapter will describe how to access the BIOS setup program and the configuration options that may be changed.

3.2 Starting Setup

The AMI BIOS™ is immediately activated when you first power on the computer. The BIOS reads the system information contained in the NVRAM and begins the process of checking out the system and configuring it. When it finishes, the BIOS will seek an operating system on one of the disks and then launch and turn control over to the operating system.

While the BIOS is in control, the Setup program can be activated in one of two ways:

By pressing or <F2> immediately after switching the system on, or

By pressing the or <F2> key when the following message appears briefly at the bottom of the screen during the POST (Power On Self Test).

Press or <F2> to enter SETUP

If the message disappears before you respond and you still wish to enter Setup, restart the system to try again by turning it OFF then ON or pressing the "RESET" button on the system case. You may also restart by simultaneously pressing <Ctrl>, <Alt>, and <Delete> keys. Remove all storage can also enter the BIOS Setup Utility.

3.3 Using Setup

In general, you use the arrow keys to highlight items, press <Enter> to select, use the PageUp and PageDown keys to change entries, press <F1> for help and press <Esc> to quit. The following table provides more detail about how to navigate in the Setup program using the keyboard.

Button	Description
↑	Move to previous item
↓	Move to next item
←	Move to the item in the left hand
→	Move to the item in the right hand
Esc key	Main Menu -- Quit and not save changes into NVRAM Status Page Setup Menu and Option Page Setup Menu -- Exit current page and return to Main Menu
+ key	Increase the numeric value or make changes
- key	Decrease the numeric value or make changes
F1 key	General help, only for Status Page Setup Menu and Option Page Setup Menu
F2 key	Previous Values.
F3 key	Optimized defaults
F4 key	Save & Exit Setup

- **Navigating Through The Menu Bar**

Use the left and right arrow keys to choose the menu you want to be in.



Note: Some of the navigation keys differ from one screen to another.

- **To Display a Sub Menu**

Use the arrow keys to move the cursor to the sub menu you want. Then press <Enter>. A “>” pointer marks all sub menus.

3.4 Getting Help

Press F1 to pop up a small help window that describes the appropriate keys to use and the possible selections for the highlighted item. To exit the Help Window press <Esc> or the F1 key again.

3.5 In Case of Problems

If, after making and saving system changes with Setup, you discover that your computer no longer is able to boot, the AMI BIOS supports an override to the NVRAM settings which resets your system to its defaults.

The best advice is to only alter settings which you thoroughly understand. To this end, we strongly recommend that you avoid making any changes to the chipset defaults. These defaults have been carefully chosen by both BIOS Vendor and your systems manufacturer to provide the absolute maximum performance and reliability. Even a seemingly small change to the chipset setup has the potential for causing you to use the override.

3.6 BIOS setup

Once you enter the Aptio Setup Utility, the Main Menu will appear on the screen. The Main Menu allows you to select from several setup functions and exit choices. Use the arrow keys to select among the items and press <Enter> to accept and enter the sub-menu.

3.6.1 Main Menu

This section allows you to record some basic hardware configurations in your computer and set the system clock.

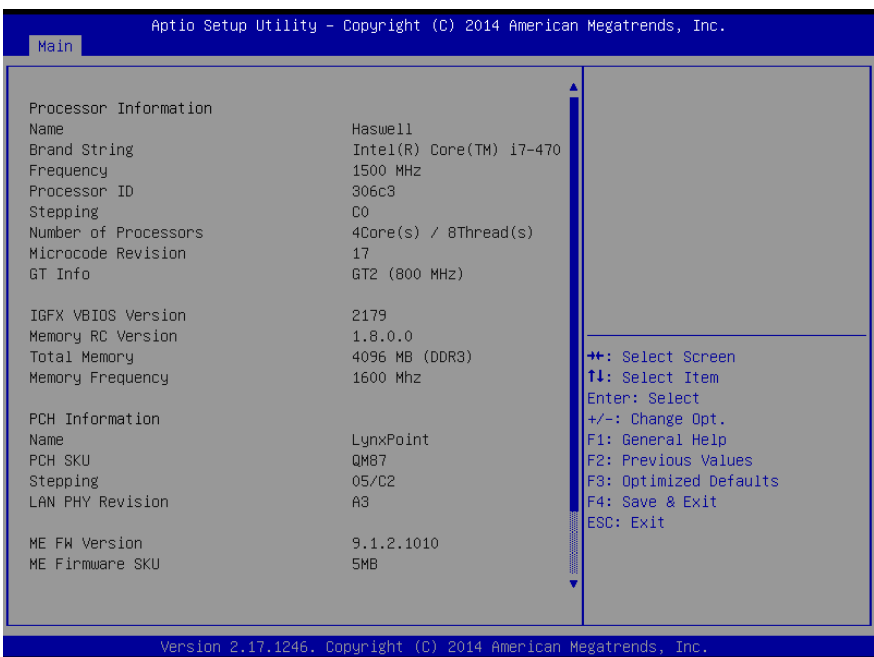

3.6.1.1 System Language

This option allows choosing the system default language.

3.6.1.2 System Date

Use the system date option to set the system date. Manually enter the day, month and year.

3.6.1.3 System Time

Use the system time option to set the system time. Manually enter the hours, minutes and seconds.



Note: The BIOS setup screens shown in this chapter are for reference purposes only, and may not exactly match what you see on your screen.

Visit the Avalue website (www.avalue.com.tw) to download the latest product and BIOS information.

3.6.2 Advanced Menu

This section allows you to configure your CPU and other system devices for basic operation through the following sub-menus.

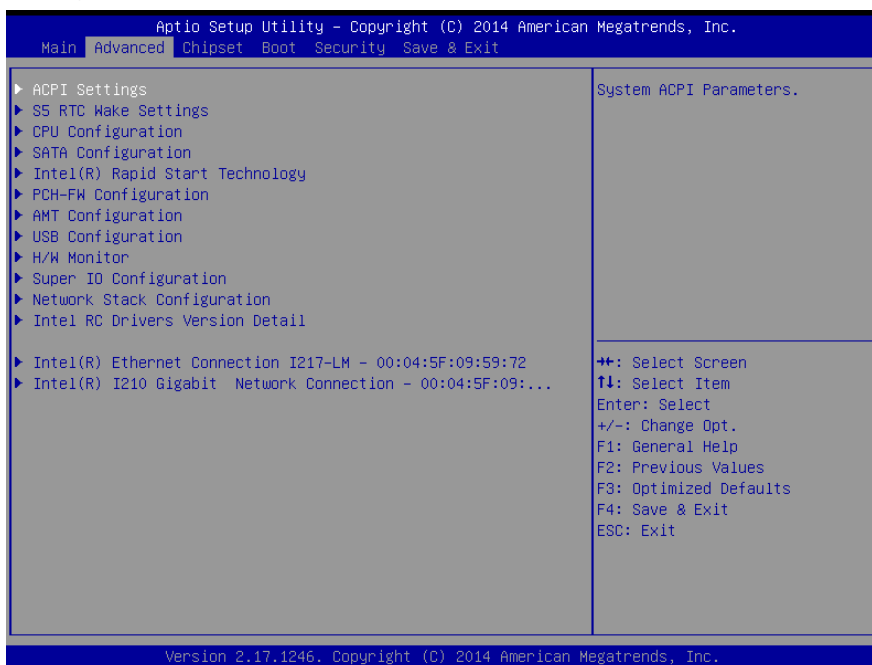

ECM-QM87R/ ECM-QM87

3.6.2.1 APCI Settings

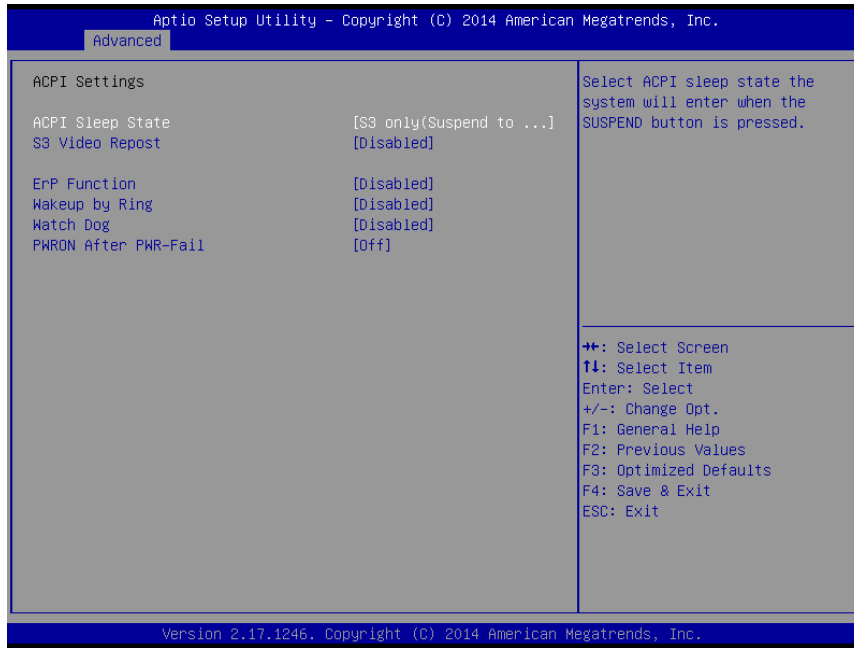

Item	Options	Description
ACPI Sleep State	Suspend Disabled S3 only(Suspend to RAM)[Default]	Select ACPI sleep state the system will enter when the SUSPEND button is pressed.
S3 Video Repost	Disabled[Default] Enabled	Enable or Disable S3 Video Repost.
ErP Function	Disabled[Default] Enabled	Enable or Disable Erp.
Wakeup by Ring	Disabled[Default] Enabled	Wakeup by Ring from S1~S5.
Watch Dog	Disabled[Default] 30 sec 40 sec 50 sec 1 min 2 min 10 min 30 min	Select WatchDog.
PWRON After PWR-Fail	Off[Default] On Former-Sts	Select PWRON After PWR-Fail.

3.6.2.2 S5 RTC Wake Settings



Item	Options	Description
Wake system with Fixed Time	Disabled[Default], Enabled	Enable or disable System wake on alarm event. When enabled, System will wake on the hr:min::sec specified.

3.6.2.3 CPU Configuration

Use the CPU configuration menu to view detailed CPU specification and configure the CPU.

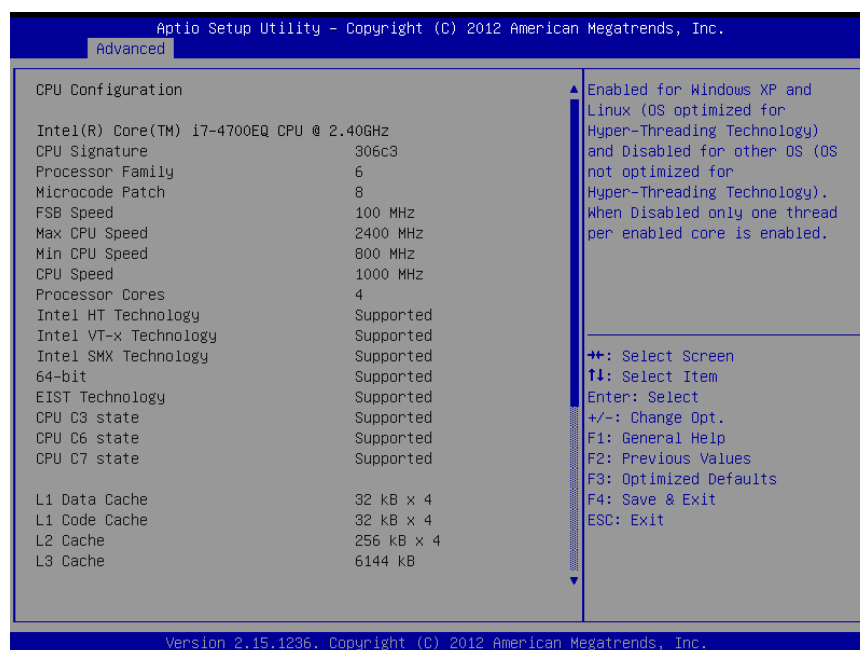

ECM-QM87R/ ECM-QM87

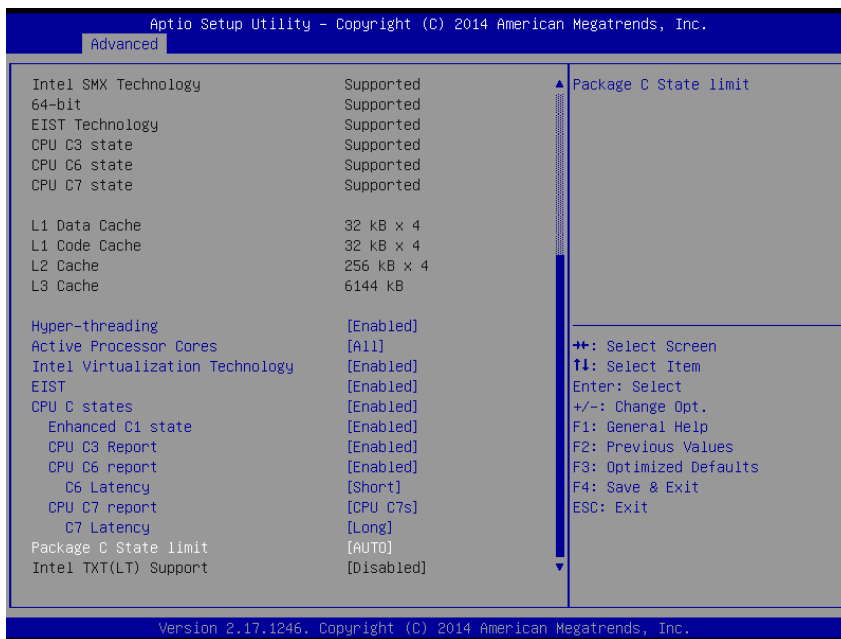

Item	Options	Description
Hyper-threading	Disabled, Enabled[Default]	Enable for Windows XP and Linux (OS optimized for Hyper-Threading Technology) and Disabled for other OS (OS not optimized for Hyper-Threading Technology). When Disabled only one thread per enabled core is enabled.
Active Processor Cores	All[Default], 1 2 3	Number of cores to enable in each processor package.
Intel Virtualization Technology	Disabled, Enabled[Default]	When enabled, a VMM can utilize the additional hardware capabilities provided by Vanderpool Technology.
EIST	Disabled, Enabled[Default]	Enable/Disable Intel SpeedStep.
CPU C states	Disabled, Enabled[Default]	Enable or disable CPU C states.
Enhanced C1 state	Disabled, Enabled[Default]	Enhanced C1 state.
CPU C3 Report	Disabled, Enabled[Default]	Enable/Disable CPU C3 report to OS.
CPU C6 Report	Disabled, Enabled[Default]	Enable/Disable CPU C6 report to OS.
C6 Latency	Short[Default] Long	Configure Short/Long latency for C6.

CPU C7 Report	Disabled, CPU C7 CPU C7s[Default]	Enable/Disable CPU C7 report to OS.
C7 Latency	Short Long[Default]	Configure Short/Long latency for C7.
Package C State limit	C0/C1 C2 C3 C6 C7 C7s AUTO[Default]	Package C State limit.
Intel TXT(LT) Support	Disabled[Default], Enabled	Enable or Disable Intel® TXT(LT) support.

3.6.2.4 SATA Configuration

It allows you to select the operation mode for SATA controller.

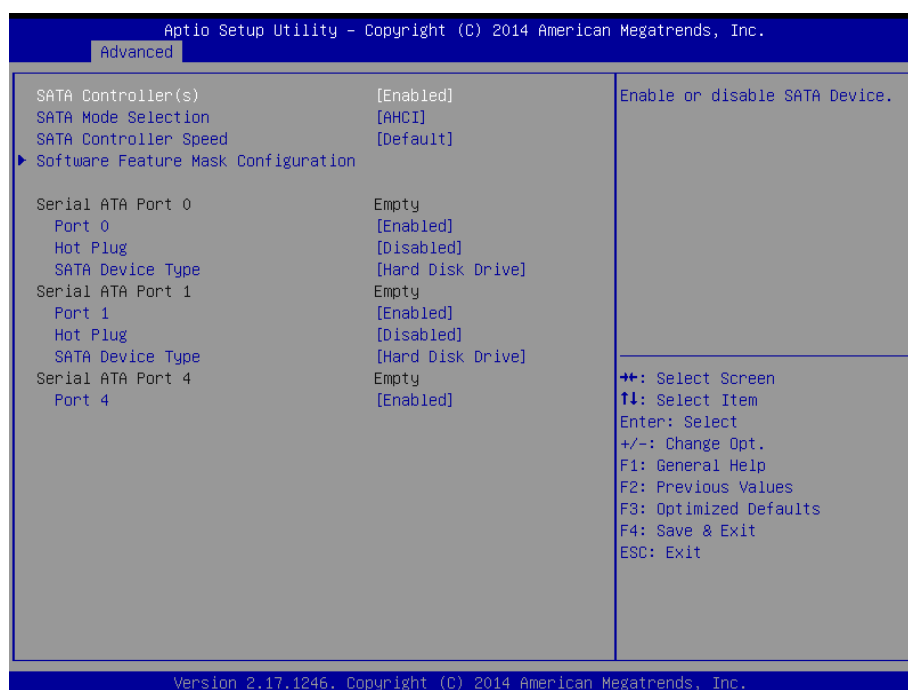

Item	Options	Description
SATA Controller(s)	Enabled[Default] Disabled	Enable or disable SATA Device.
SATA Mode Selection	IDE AHCI[Default] RAID	Determines how SATA controller(s) operate.
SATA Controller Speed	Disabled[Default] Gen1 Gen2 Gen3	Indicates the maximum speed the SATA controller can support.

ECM-QM87R/ ECM-QM87

Software Feature Mask Configuration	RAID OROM/RST driver will refer to the SWFM configuration to enable or disable the storage features.	
Port 0/1/4	Enabled[Default] Disabled	Enable or Disable SATA Port.
Hot Plug	Disable[Default], Enable	Designates this port as Hot Pluggable.
SATA Device Type	Hard Disk Drive[Default] Solid State Drive	Identify the SATA port is connected to Solid State Drive or Hard Disk Drive.

3.6.2.5 Intel(R) Rapid Start Technology



Item	Options	Description
Intel® Rapid Start Technology	Disabled[Default], Enabled	Enable or disable Intel® Rapid Start Technology.

3.6.2.6 PCH-FW Configuration



Item	Options	Description
MDES BIOS Status Code	Disabled[Default] Enabled	Enable/Disable MDES BIOS Status Code.
Firmware Update Configuration	Configure Management Engine Technology Parameters.	

3.6.2.6.1 Firmware Update Configuration

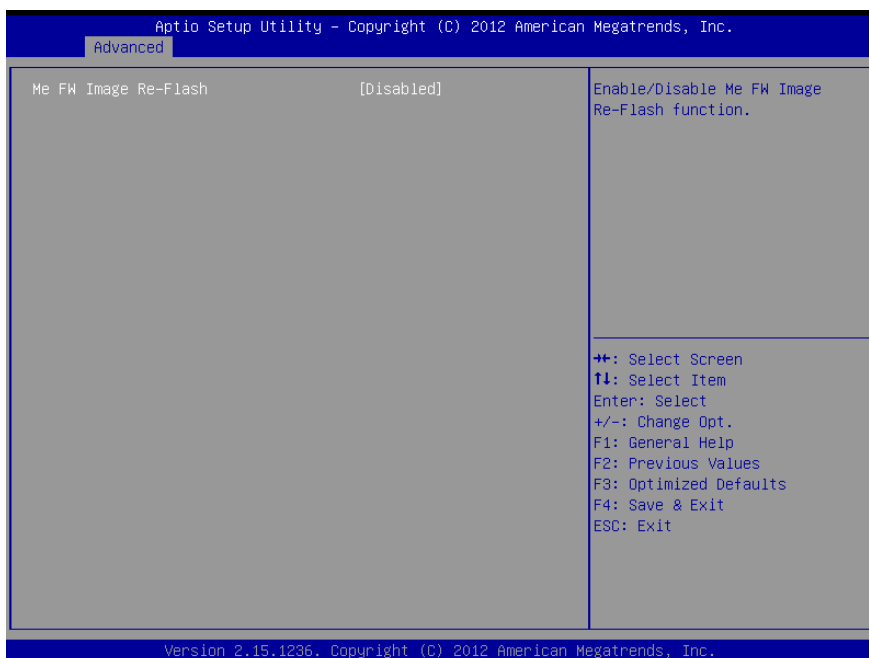

Item	Options	Description
Me FW Image Re-Flash	Disabled[Default] Enabled	Enable/Disable Me FW Image Re-Flash function.

ECM-QM87R/ ECM-QM87

3.6.2.7 AMT Configuration

Intel AMT allows hardware-based remote management, security, power-management, and remote-configuration features.

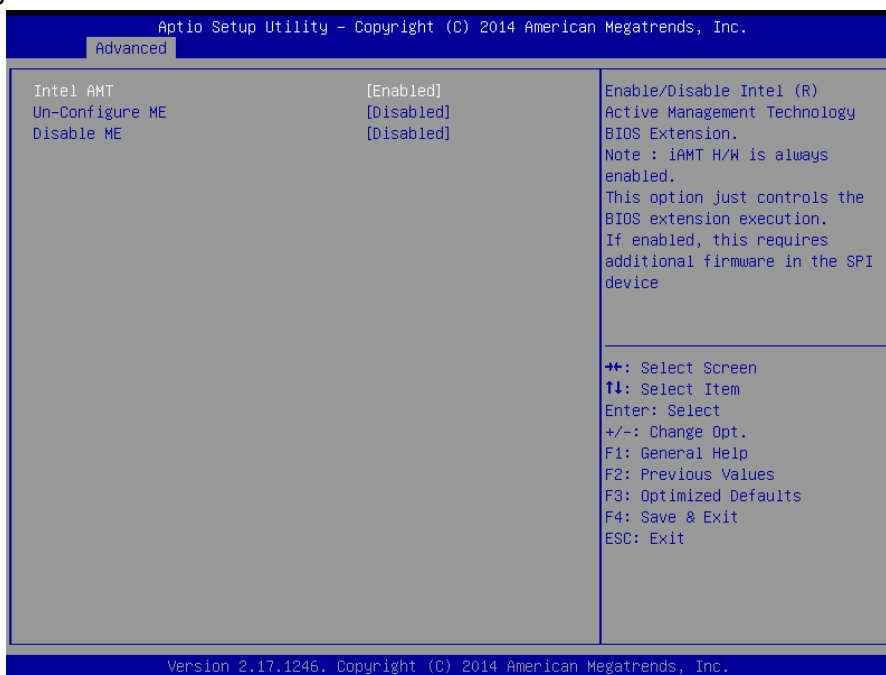

Item	Options	Description
Intel AMT	Enabled[Default] Disabled	Enable/Disable Intel © Active Management Technology BIOS Extension. Note: iAMT H/W is always enabled. This option just controls the BIOS extension execution. If enabled, this requires additional firmware in the SPI device
Un-Configure ME	OEMFLag Bit 15: Un-Configure ME without password	
Disable ME	Enabled[Default] Disabled	Set ME to Soft Temporary Disabled.

3.6.2.8 USB Configuration

The USB Configuration menu helps read USB information and configures USB settings.

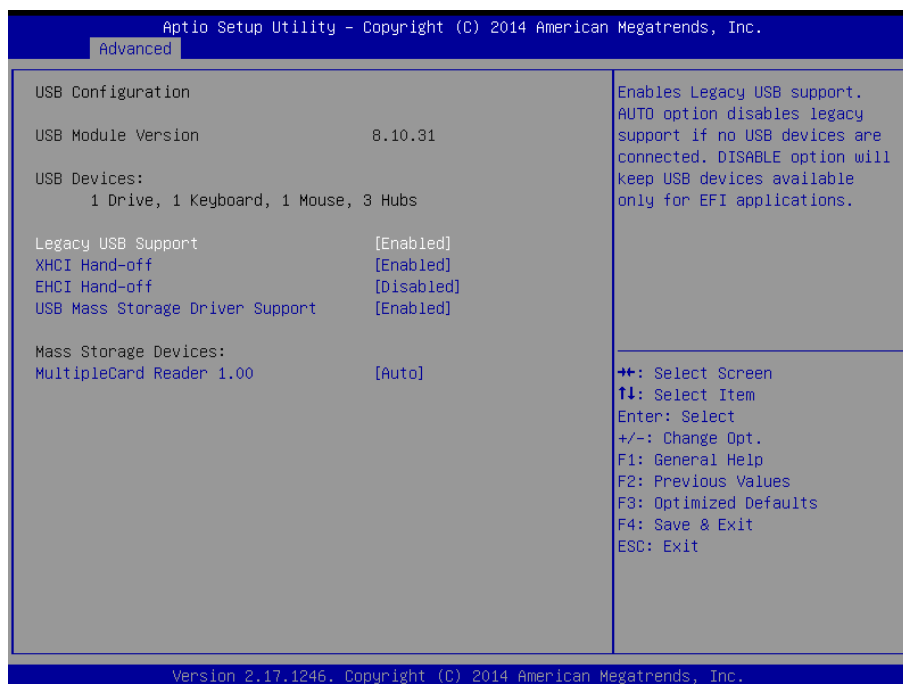

Item	Options	Description
Legacy USB Support	Enabled[Default] Disabled Auto	Enables Legacy USB support. AUTO option disables legacy support if no USB devices are connected. DISABLE option will keep USB devices available only for EFI applications.
XHCI Hand-off	Enabled[Default] Disabled	This is a workaround for OSeW without XHCI hand-off support. The XHCI ownership change should be claimed by XHCI driver.
EHCI Hand-off	Enabled Disabled[Default]	This is a workaround for OSeS without EHCI hand-off support. The EHCI ownership change should be claimed by EHCI driver.
USB Mass Storage Driver Support	Enabled[Default] Disabled	Enable/Disable USB Mass Storage Driver Support.

ECM-QM87R/ ECM-QM87

3.6.2.9 Hardware Monitor

Displays system health status



Item	Description
Smart Fan Function	Enable or Disable Smart Fan.

The following system temperature, fan speed and voltage are monitored.

Temperature:

- System Temperature
- CPU Thermistor Temperature

Fan Speed:

- System Fan Speed
- CPU Fan speed

Voltage:

- VCORE
- +12V
- +5V
- +5VSB
- AVCC
- 3VCC
- VSB3
- VBAT

3.6.2.10 Super IO Configuration

You can use this item to set up or change the Super IO configuration for serial ports. Please refer to 3.6.2.10.1 and 3.6.2.10.2 for more information.



Item	Description
Serial Port 1 Configuration	Set Parameters of Serial Port 1 (COMA).
Serial Port 2 Configuration	Set Parameters of Serial Port 2 (COMB).

3.6.2.10.1 Serial Port 1 Configuration

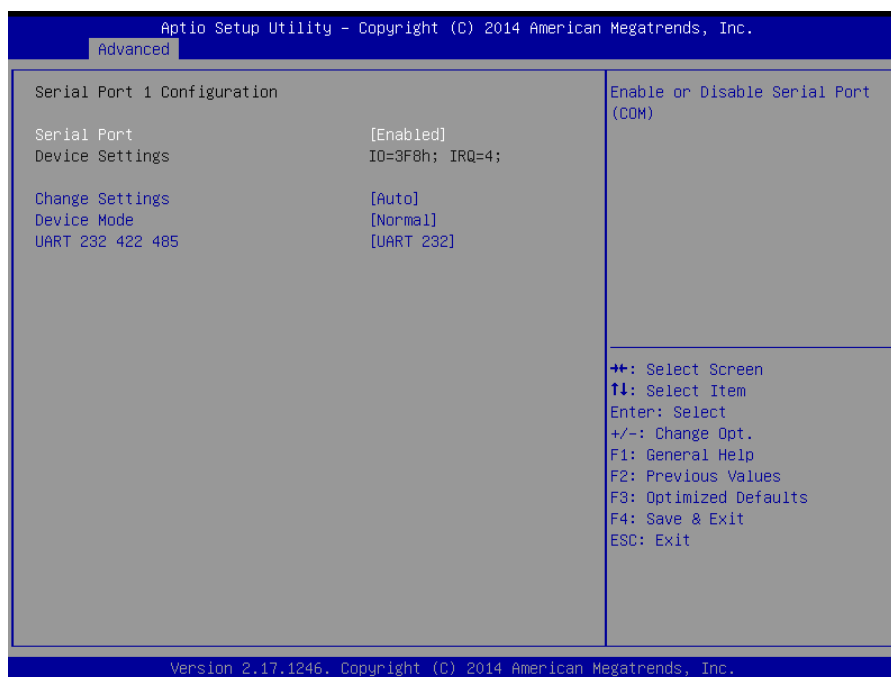

ECM-QM87R/ ECM-QM87

Item	Option	Description
Serial Port	Enabled, Disabled[Default]	Enable or Disable Serial Port (COM).
Change Settings	Auto[Default] IO=3F8h; IRQ=4, IO=3F8h; IRQ=3,4,5,6,7,9,10,11,12 IO=2F8h; IRQ=3,4,5,6,7,9,10,11,12 IO=3E8h; IRQ=3,4,5,6,7,9,10,11,12 IO=2E8h; IRQ=3,4,5,6,7,9,10,11,12	Select an optimal setting for Super IO device.
Device Mode	Normal[Default] High Speed	Change the Serial Port mode. Select <High Speed> or <Normal mode> mode.
UART 232 422 485	UART 232[Default], UART 422, UART 485	Change the Serial Port as RS232/ 422/ 485

3.6.2.10.2 Serial Port 2 Configuration

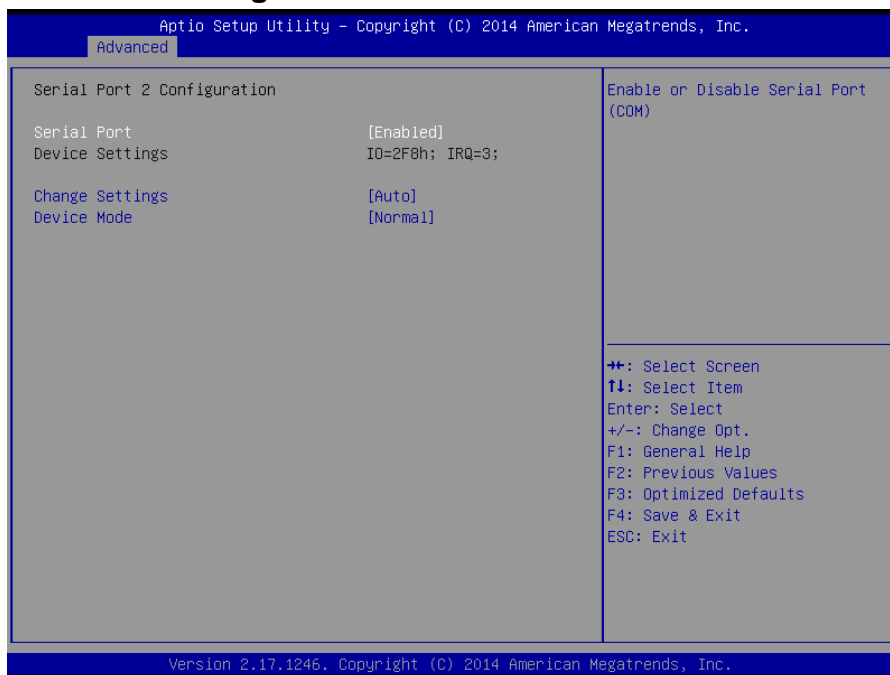

Item	Option	Description
Serial Port	Enabled, Disabled[Default]	Enable or Disable Serial Port (COM).
Change Settings	Auto[Default] IO=2F8h; IRQ=3 IO=3F8h; IRQ=3,4,5,6,7,9,10,11,12 IO=2F8h; IRQ=3,4,5,6,7,9,10,11,12 IO=3E8h; IRQ=3,4,5,6,7,9,10,11,12 IO=2E8h; IRQ=3,4,5,6,7,9,10,11,12	Select an optimal setting for super IO device.
Device Mode	Normal[Default] High Speed	Change the Serial Port mode. Select <High Speed> or <Normal mode> mode.

3.6.2.11 Network Stack

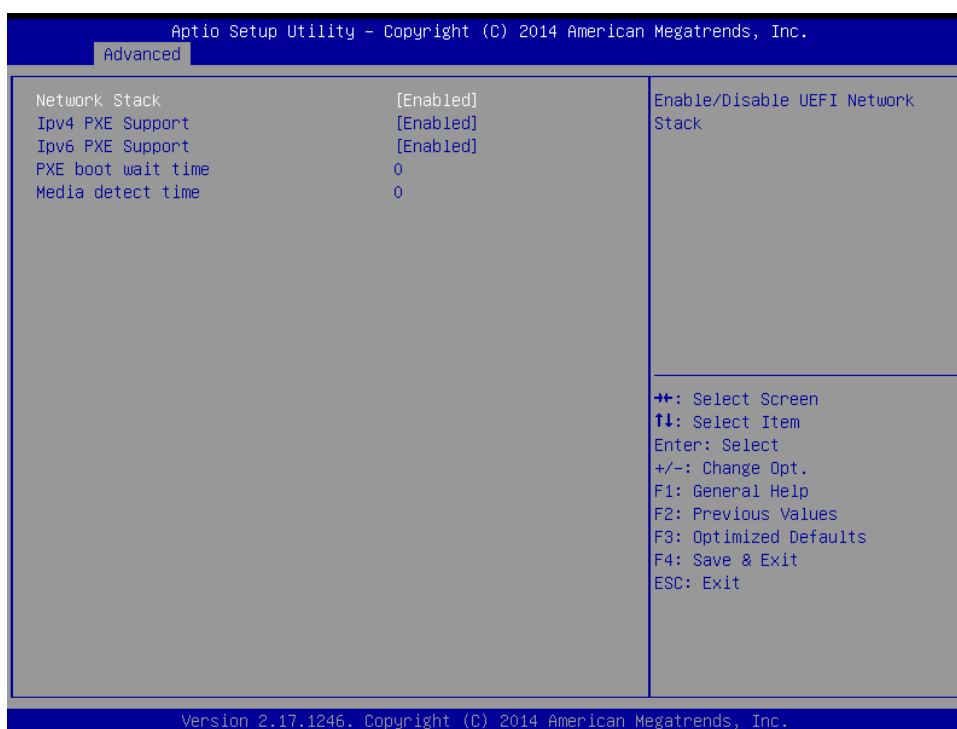
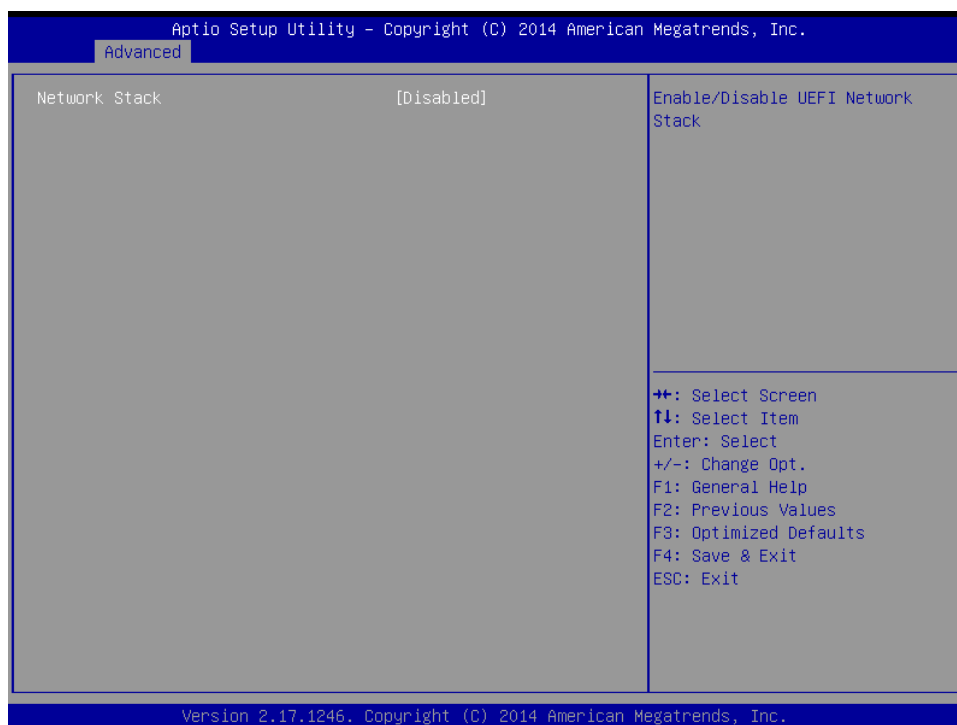

Item	Option	Description
Network stack	Enabled Disabled[Default]	Enable/Disable UEFI network stack.
Ipv4/6 PXE Support	Enabled Disabled[Default]	Enable Ipv4/6 PXE Boot Support. If disabled IPV4/6 PXE boot option will not

ECM-QM87R/ ECM-QM87

		be created.
PXE boot wait time	0[Default] 5	Wait time to press ESC key to abort the PXE boot.
Media detect time	0[Default] 50	Enable/Disable UEFI network stack.

3.6.2.12 Intel RC Drivers Version Detail

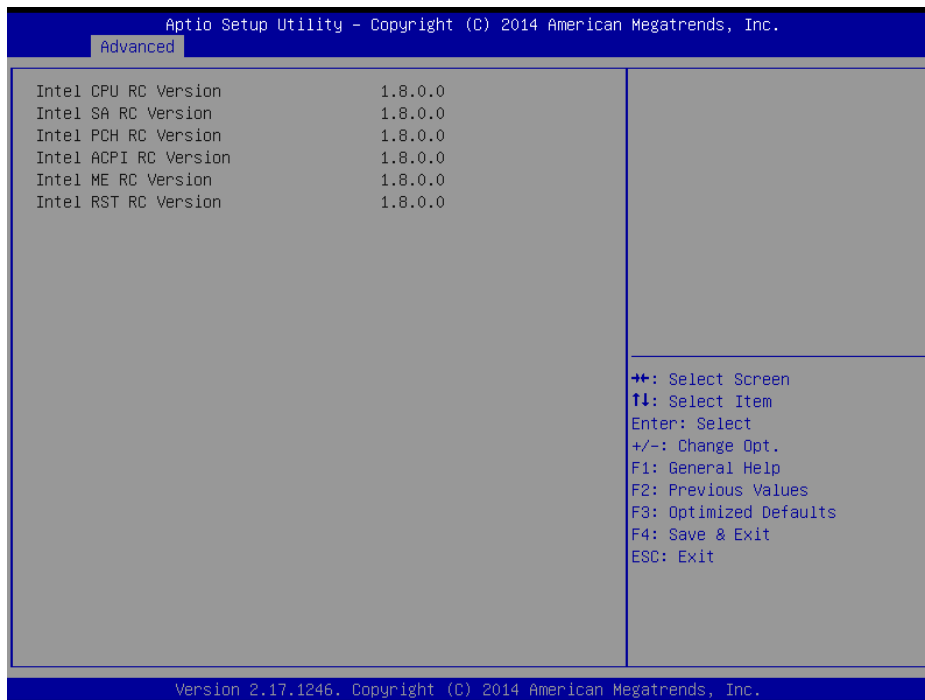

3.6.3 Chipset

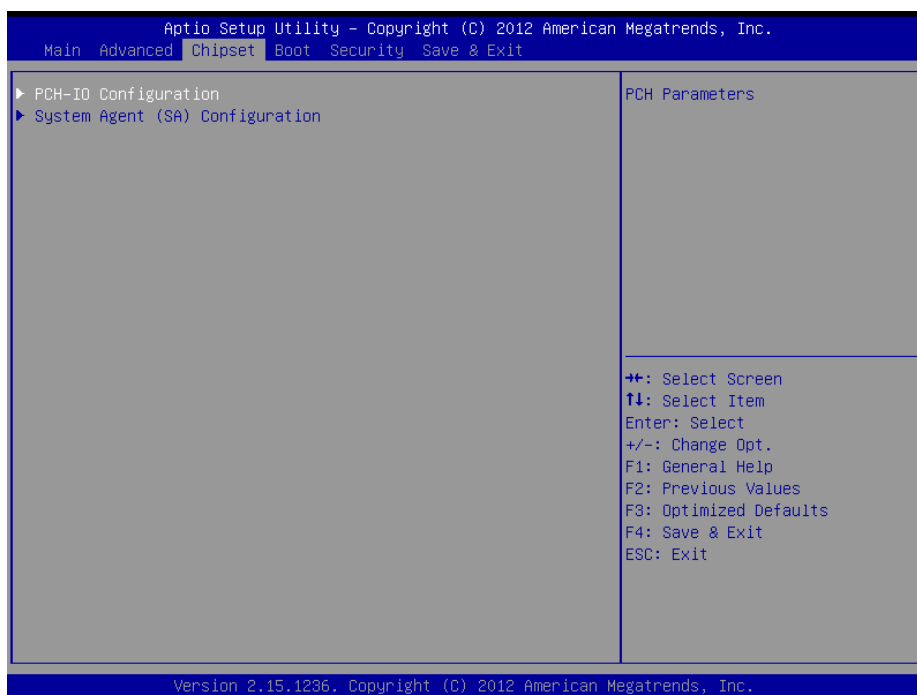

3.6.3.1 PCH-IO Configuration



Item	Option	Description
PCI Express Configuration	PCI Express Configuration settings.	
USB Configuration	USB Configuration settings.	
PCH Azalia Configuration	PCH Azalia Configuration settings.	
PCH LAN Controller	Disabled Enabled[Default]	Enable or disable onboard NIC.
SLP_S4 Assertion Width	Disabled 1-2 Seconds 2-3 Seconds 3-4 Seconds 4-5 Seconds[Default]	Select a minimum assertion width of the SLP_S4# signal.

3.6.3.1.1 PCI Express Configuration

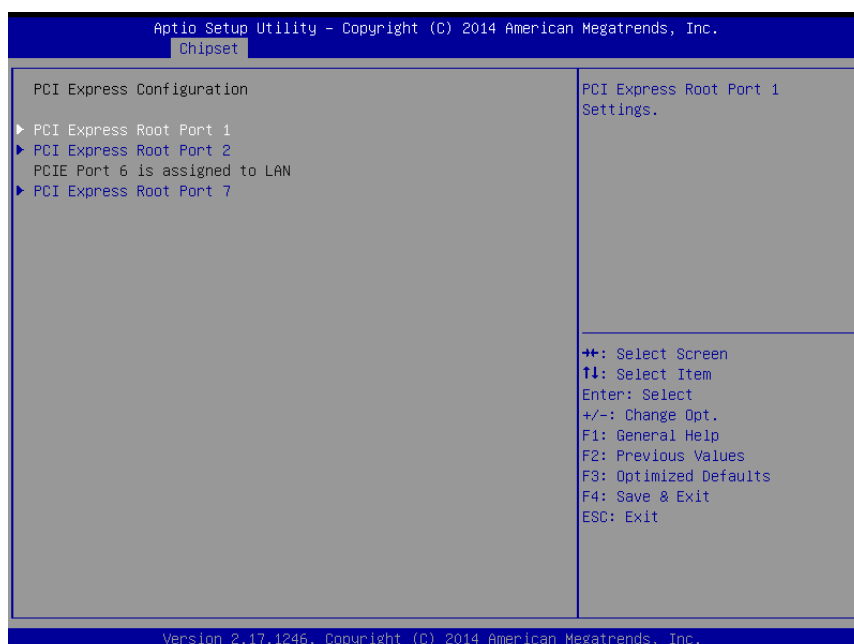

ECM-QM87R/ ECM-QM87

Item	Option	Description
PCI Express Root Port 1	PCI Express Root Port 1 Settings.	
PCI Express Root Port 2	PCI Express Root Port 2 Settings.	
PCI Express Root Port 7	PCI Express Root Port 7 Settings.	
PCH LAN Controller	Enabled[Default] Disabled	Enable or disable onboard NIC.
SLP_S4 Assertion Width	Disabled 1-2 Seconds 2-3 Seconds 3-4 Seconds, 4-5 Seconds[Default]	Select a minimum assertion width of SLEP_S4# signal.

3.6.3.1.1.1 PCI Express Root Port 1

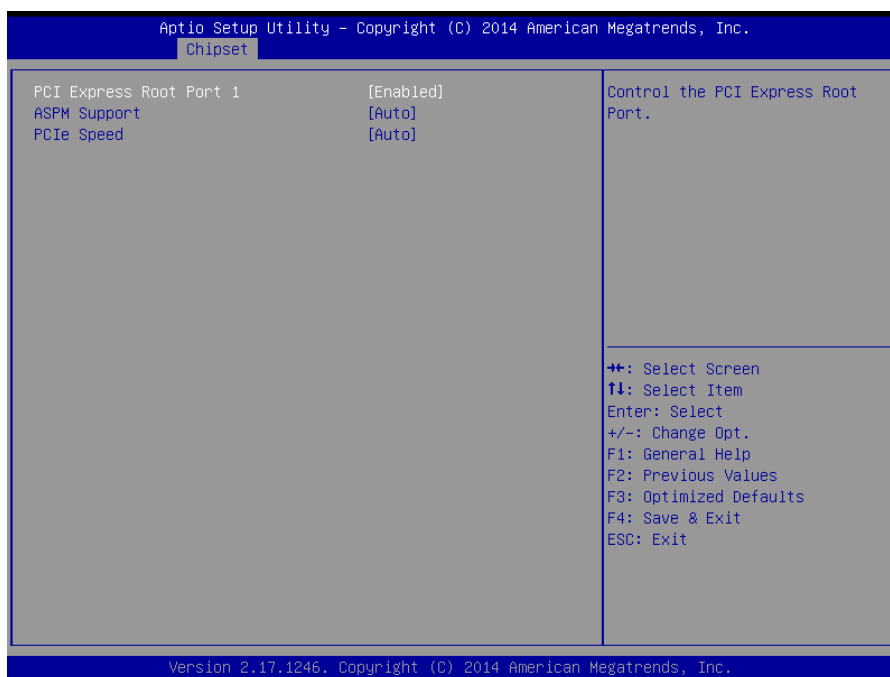

Item	Option	Description
PCI Express Root Port 1/2/7	Disabled Enabled[Default]	Control the PCI Express Root Port.
ASPM Support	Disabled L0s L1 L0sL1 Auto[Default]	Set the ASPM Level: Force L0s-Force all links to L0s State: AUTO-BIOS auto configure: DISABLE-Disables ASPM.
PCIe Speed	Auto[Default] Gen1 Gen2	Select PCI Express port speed.

3.6.3.1.2 USB Configuration



Item	Option	Description
xHCI Mode	Smart Auto[Default] Disabled	Mode of operation of xHCI controller.
USB Ports Per-Port Disable Control	Disabled[Default] Enabled	Control each of the USB ports (0~13) disabling.

3.6.3.1.3 PCH Azalia Configuration



ECM-QM87R/ ECM-QM87

Item	Option	Description
Azalia	Disabled Enabled Auto[Default]	Control Detection of the Azalia device. Deisabled = Azalia will be unconditionally disabled Enabled = Azalia will be unconditionally Enabled Auto = Azalia will be enabled if present, disabled otherwise.

3.6.3.2 System Agent (SA) Configuration

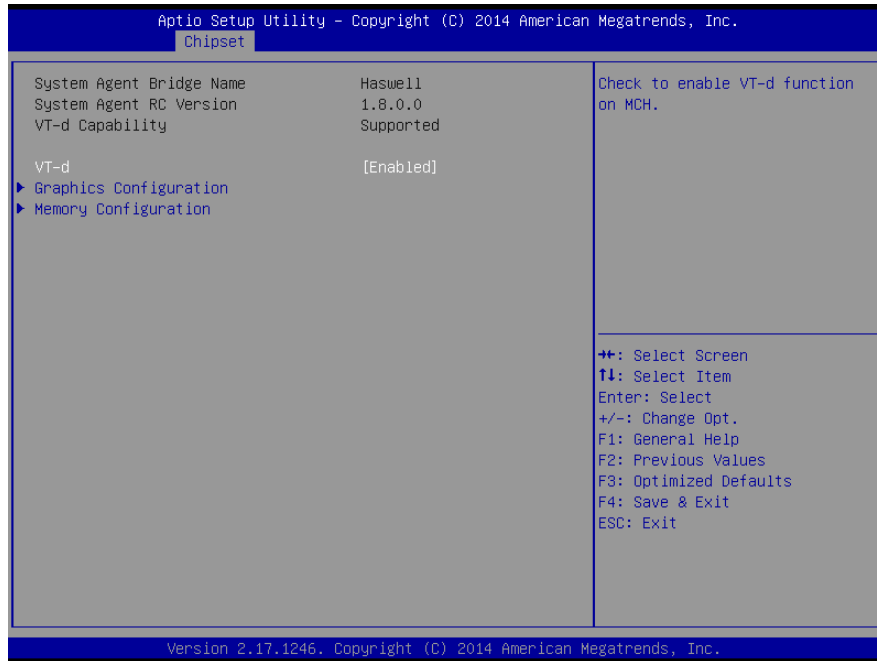

3.6.3.2.1 Graphics Configuration

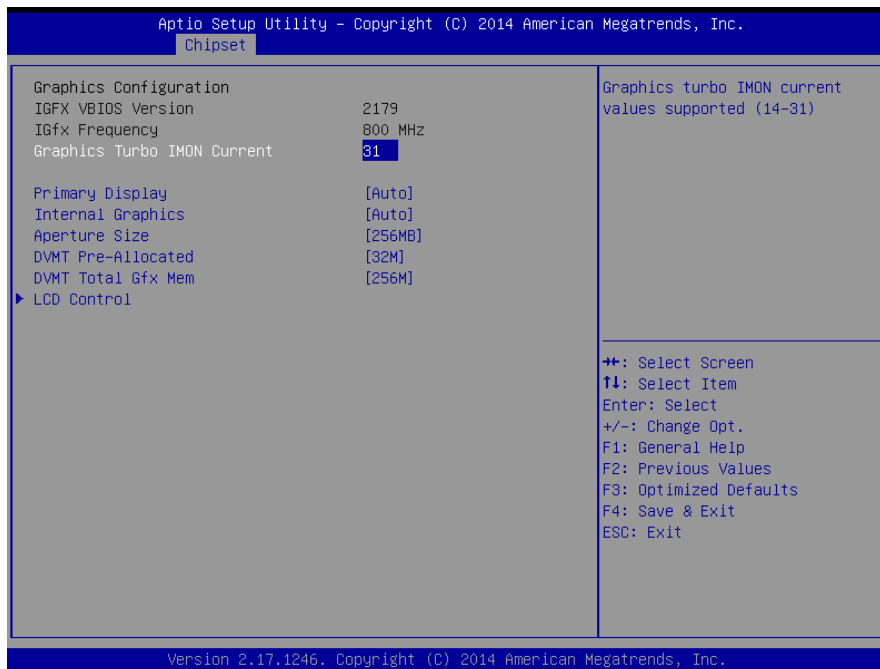

Item	Option	Description
Graphics Turbo IMON Current	14 ~31[Default]	Graphics turbo IMON current values supported (14 -31).

Primary Display	Auto[Default] IGFX PCIE	Select which of Auto/IGFX/PCIE Graphics device should be Primary Display.
Internal Graphics	Auto[Default] Disabled Enabled	Keep IGD enabled based on the setup options.
Aperture Size	[128MB] [256MB] [Default] [512MB]	Select the Aperture Size
DVMT Pre-Allocated	[32M] [Default] [64M] [96M] [128M] [160M] [192M] [224M] [256M] [288M] [320M] [352M] [384M] [416M] [448M] [480M] [512M] [1024M]	Select DVMT 5.0 Pre-Allocated (Fixed) Graphics Memory size used by the Internal Graphics Device.
DVMT Total Gfx Mem	[128M] [256M] [Default] [MAX]	Select DVMT5.0 Total Graphic Memory size used by the Internal Graphics Device.
LCD Control	LCD Control	

3.6.3.2.1.1 LCD Control

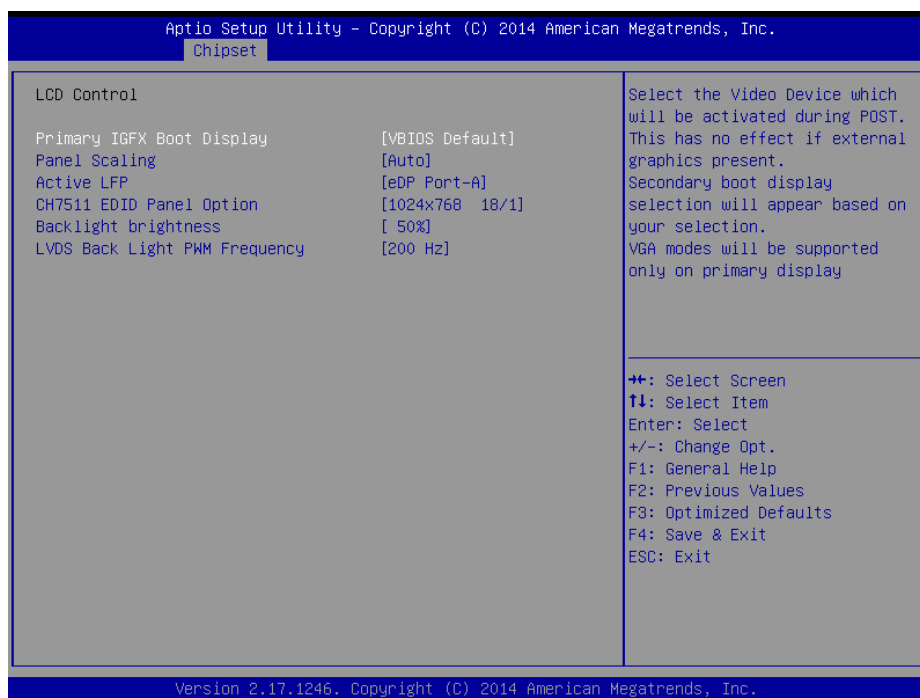

Item	Option	Description
Primary IGFX Boot Display	VBIOS Default[Default] CRT HDMI LVDS	Select the Video Device which will be activated during POST. This has no effect if external graphics present. Secondary boot display selection will appear based on your selection. VGA modes will be supported only on primary display.

ECM-QM87R/ ECM-QM87

<p>Panel Scaling</p>	<p>Auto[Default] Off Force Scaling</p>	<p>Select the LCD panel scaling option used by the Internal Graphics Device.</p>
<p>Active LFP</p>	<p>No LVDS eDP Port-A[Default]</p>	<p>Select the Active LFP Configuration. No LVDS:VBIOS does not enable LVDS. Int-LVDS. Int-LVDS:BIOS enables LVDS driver by Integrated encoder. SDVO LVDS:VBIOS enables LVDS driver by SDVO encoder. eDP Port-A:LFP Driven by Int-DisplayPort encoder from Port-A. eDP Port-D:LFP Driven by Int-DisplayPort encoder from Port-D9through PCH).</p>
<p>CH7511 EDID Panel Option</p>	<p>1024x768 24/1 800x600 18/1 1024x768 18/1[Default] 1366x768 18/1 1024x600 18/1 1280x800 18/1 1920x1200 24/2 640x480 18/1 800x480 18/1 1920x1080 18/2 1280x1024 24/2 1440x900 18/2 1600x1200 24/2 1366x768 24/1 1920x1080 24/2 1680x1050 24/2</p>	<p>Port-EDP to LVDS(Chrotel7511) Panel EDID Option.</p>
<p>Backlight brightness</p>	<p>0% 25% 50%[Default] 75% 100%</p>	<p>Select LVDS back light PWM duty.</p>
<p>LVDS Back Light PWM Frequency</p>	<p>200 Hz[Default] 300 Hz 400 Hz 500 Hz 700 Hz 1 kHz 2 kHz 3 kHz 5 kHz 10 kHz 20 kHz</p>	<p>Select LVDS back light PWM Frequency.</p>

3.6.3.2.2 Memory Configuration

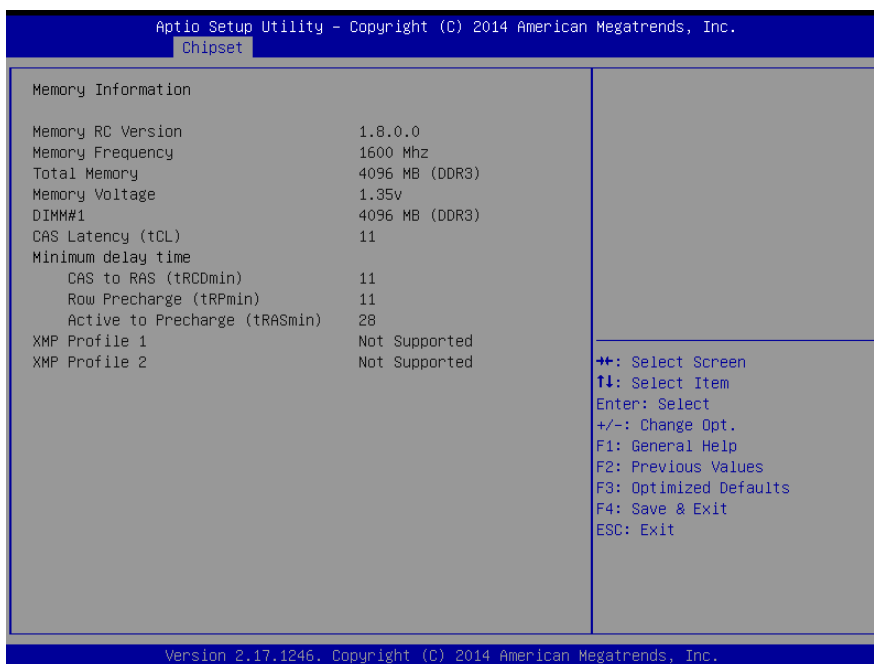

3.6.4 Boot

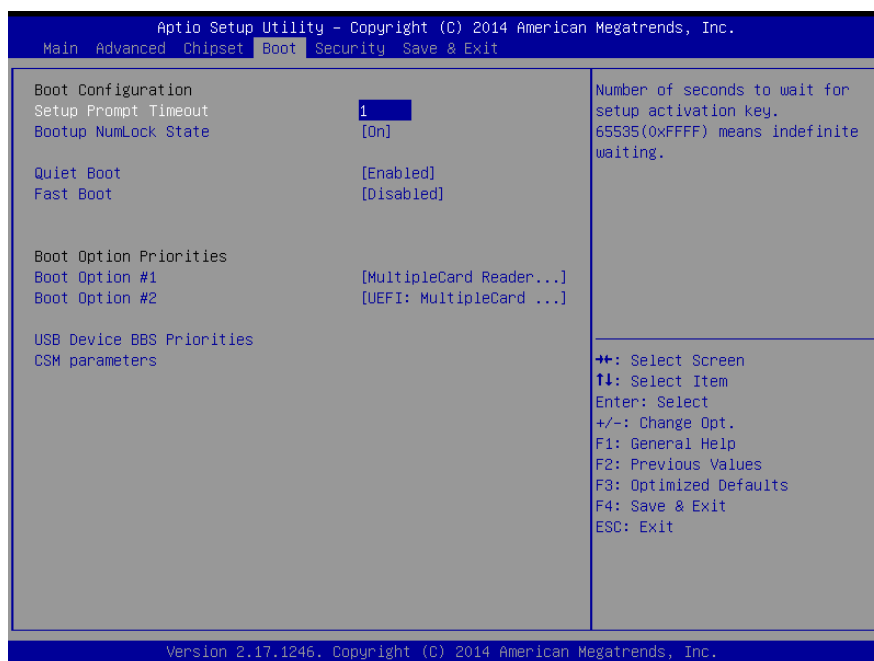

Item	Option	Description
Setup Prompt Timeout	1~ 65535	Number of seconds to wait for setup activation key. 65535(0xFFFF) means indefinite waiting.
Bootup NumLock State	On Off[Default]	Select the Keyboard NumLock state
Quiet Boot	Disabled Enabled[Default]	Enables or disables Quiet Boot option
Fast Boot	Disabled[Default] Enabled	Enables or disables boot with initialization of a minimal set of devices

ECM-QM87R/ ECM-QM87

		required to launch active boot option. Has no effect for BBS boot options.
Boot Option #1	Set the system boot order.	
CSM parameters	OpROM execution, boot options filter, etc.	

3.6.4.1 CSM parameters



Item	Option	Description
Launch CSM	Disabled Enabled[Default]	This option controls if CSM will be launched.
Boot option filter	UEFI and Legacy[Default] Legacy only UEFI only	This option controls what devices system can boot to.
Launch PXE OpROM policy	Do not launch[Default] UEFI only Legacy only	Controls the execution of UEFI and Legacy PXE OpROM.
Launch Storage OpROM policy	Do not launch UEFI only Legacy only[Default]	Controls the execution of UEFI and Legacy Storage OpROM.
Launch Video OpROM policy	Do not launch UEFI only Legacy only[Default]	Controls the execution of UEFI and Legacy Video OpROM.
Other PCI device ROM priority	UEFI OpROM[Default] Legacy OpROM	For PCI devices other than Network, Mass storage or Video defines which OpROM to launch.

3.6.5 Security



- **Administrator Password**

Set setup Administrator Password

- **User Password**

Set User Password

3.6.6 Save and exit

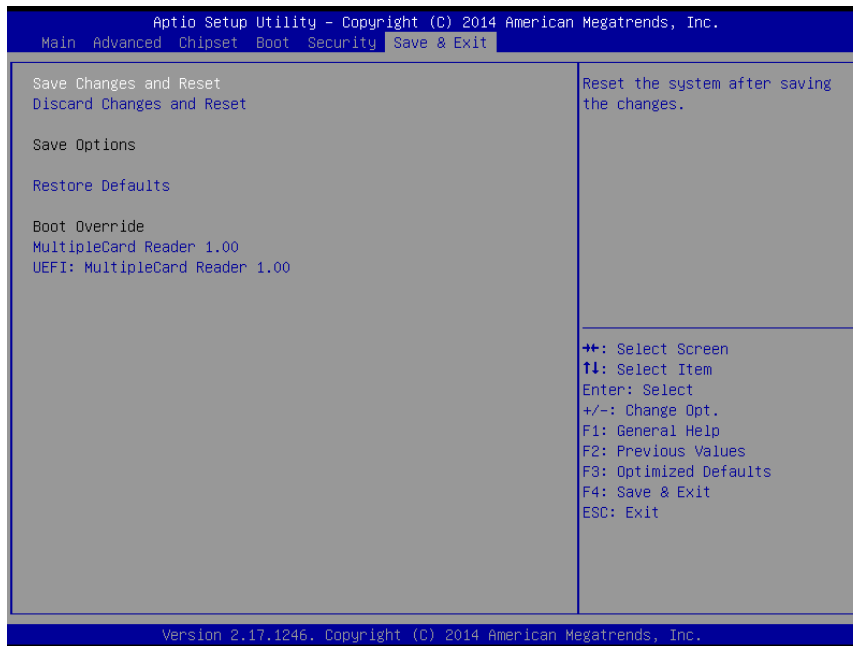

3.6.6.1 Save Changes and Exit

Exit system setup after saving the changes.

3.6.6.2 Discard Changes and Reset

Any changes made to BIOS settings during this session of the BIOS setup program are discarded. The setup program then exits and reboots the controller.

4. Drivers Installation



Note: Installation procedures and screen shots in this section are for your reference and may not be exactly the same as shown on your screen.

4.1 Install Chipset Driver (For Intel QM87)

Insert the Supporting DVD-ROM to DVD-ROM drive, and it should show the index page of Avalue's products automatically. If not, locate Index.htm and choose the product from the menu left, or link to

\\Driver_Chipset\Intel\ECM-QM87_INF.



Note: The installation procedures and screen shots in this section are based on Windows 7 operation system. If the warning message appears while the installation process, click Continue to go on.

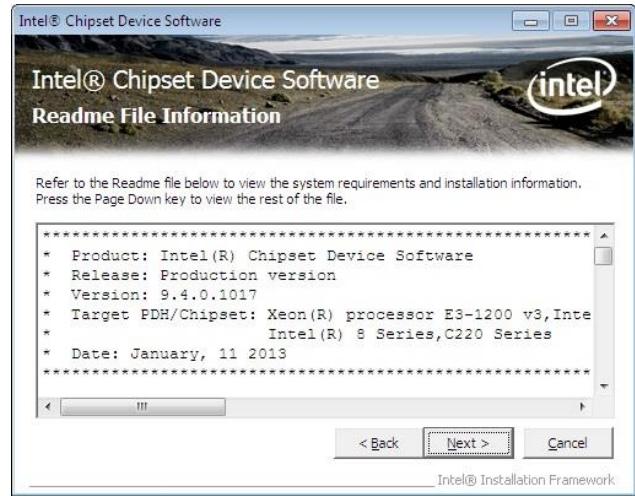

Step 3. Click Next.



Step1. Click Next..



Step 4. Click Next.



Step 2. Click Yes.



Step 5. Click Finish to complete setup.

4.2 Install ME Driver (For Intel QM87)

Insert the Supporting DVD-ROM to DVD-ROM drive, and it should show the index page of Avalue's products automatically. If not, locate Index.htm and choose the product from the menu left, or link to \Utility\ECM-QM87_ME.



Note: The installation procedures and screen shots in this section are based on Windows 7 operation system. If the warning message appears while the installation process, click Continue to go on.

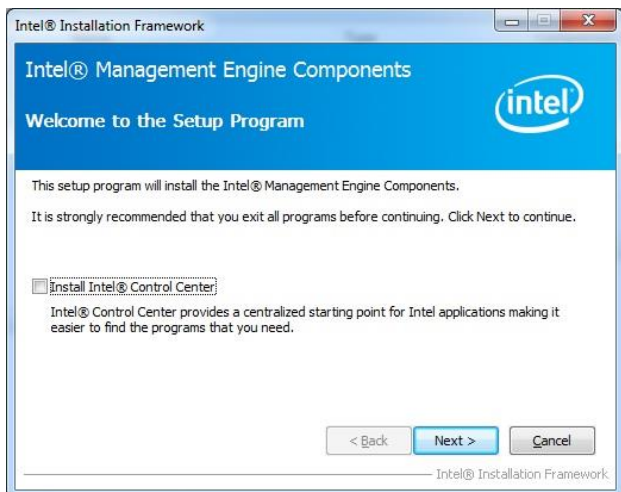

Step1. Click **Next** to start installation.

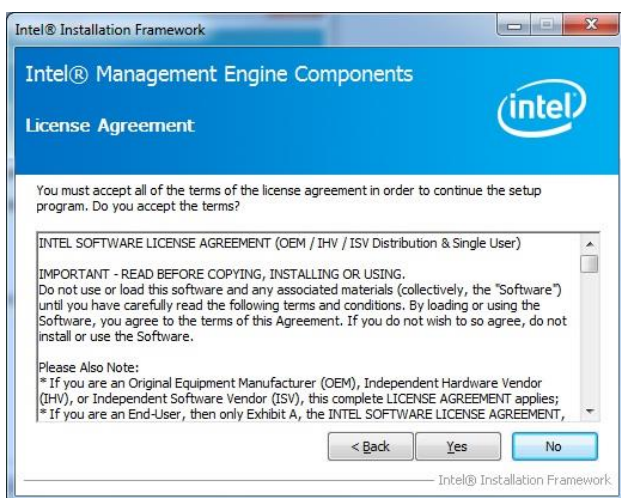

Step 2. Click **Yes** to accept license agreement.

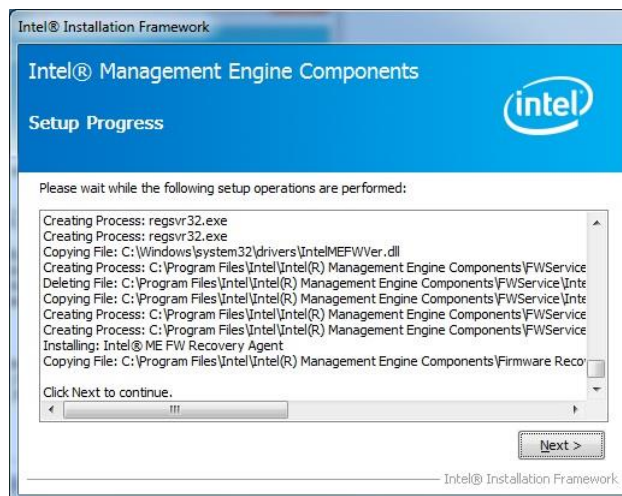

Step 3. Click **Next** to proceed setup.



Step 4. Click **Finish** to complete setup.

4.3 Install USB 3.0 Driver (For Intel QM87)

Insert the Supporting DVD-ROM to DVD-ROM drive, and it should show the index page of Avalue's products automatically. If not, locate Index.htm and choose the product from the menu left, or link to \Utility\ECM-QM87_USB 3.0.



Note: The installation procedures and screen shots in this section are based on Windows 7 operation system. If the warning message appears while the installation process, click Continue to go on.



Step 3. Click **Next** to continue installation.



Step1. Click **Next** to start installation.

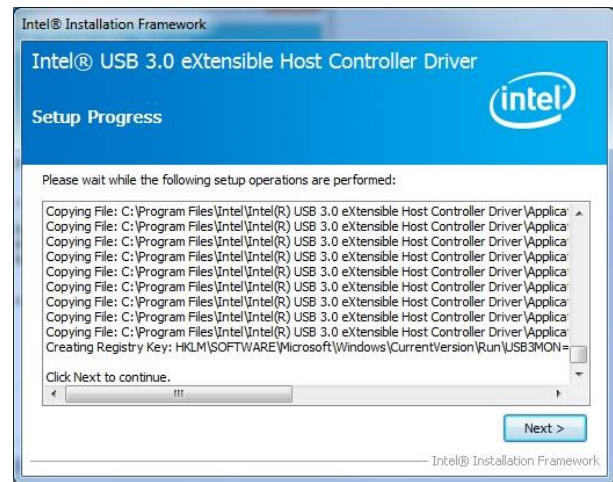

Step 4. Click **Next** to continue installation.

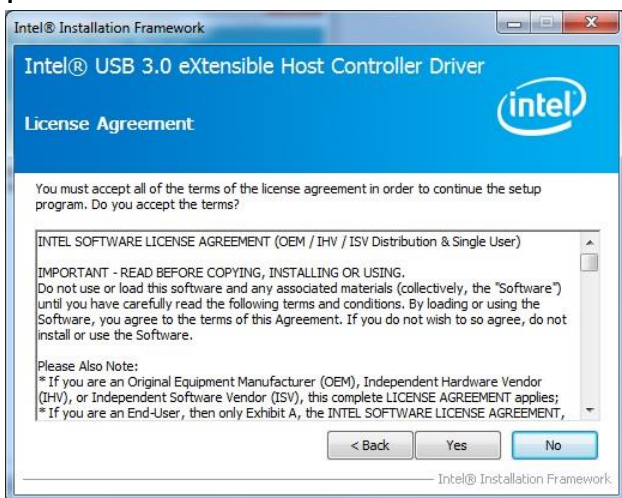

Step 2. Click **Yes**.

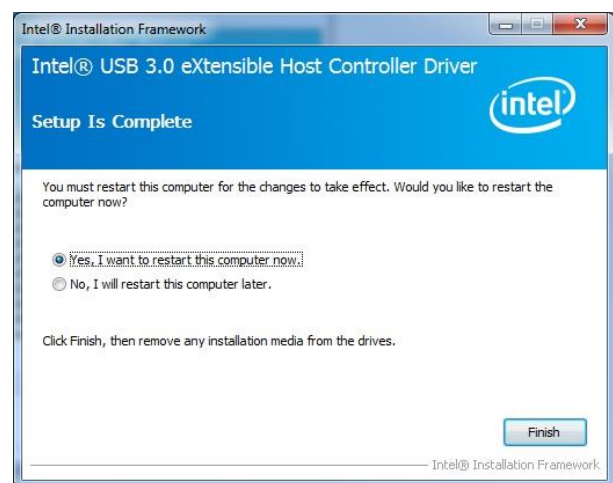

Step 5. Click **Finish** to complete setup.

4.4 Install VGA Driver (For Intel QM87)

Insert the Supporting DVD-ROM to DVD-ROM drive, and it should show the index page of Avalue's products automatically. If not, locate Index.htm and choose the product from the menu left, or link to **VGA\ECM-QM87_VGA**.



Note: The installation procedures and screen shots in this section are based on Windows XP operation system.

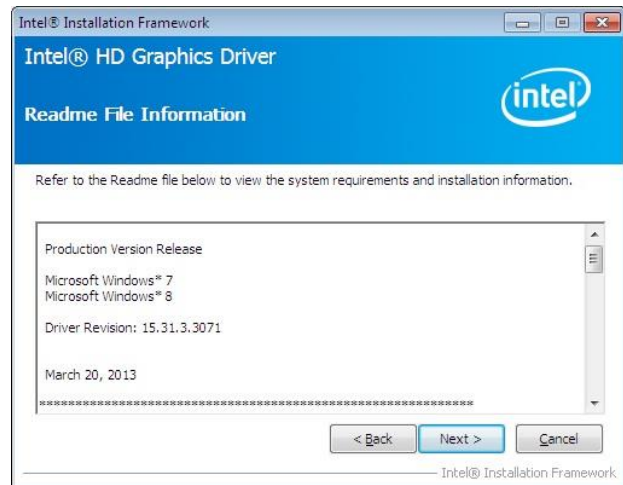

Step 3. Click Next.

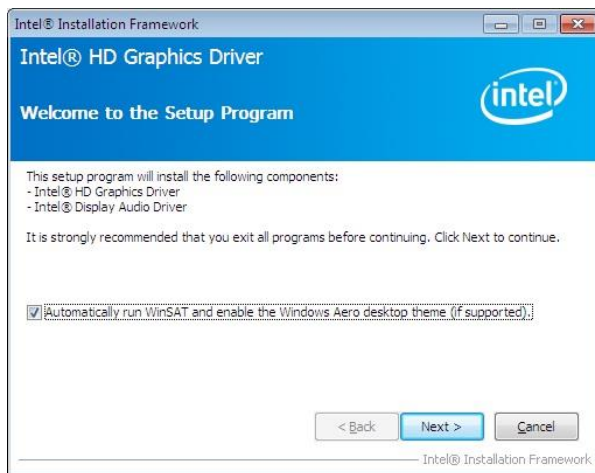

Step 1. Click Next to continue installation.

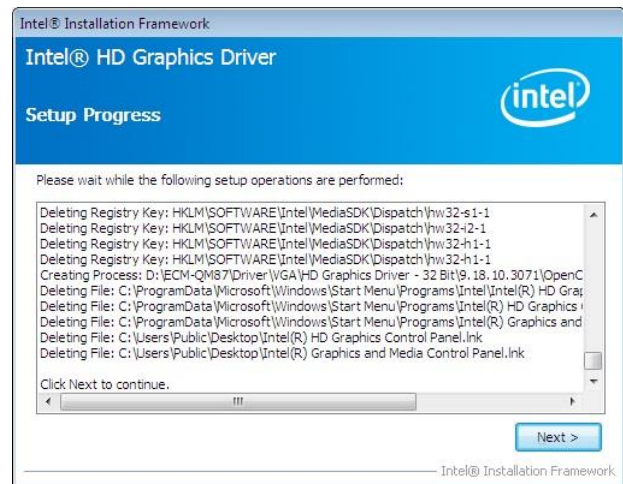

Step 4. Click Next.



Step 2.
Click **Yes** to accept license agreement.

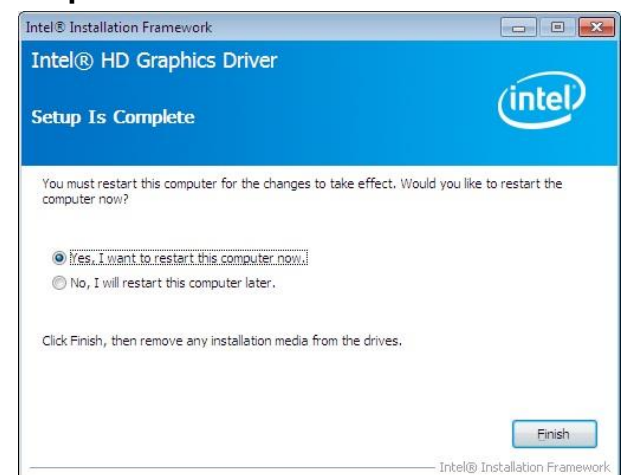

Step 5. Click Finish to complete setup.

4.5 Install Audio Driver (For Realtek ALC892)

Insert the Supporting CD-ROM to CD-ROM drive, and it should show the index page of Avalue's products automatically. If not, locate Index.htm and choose the product from the menu left, or link to **\\Driver_Audio\Realtek\ALC892\ECM-QM87_Audio**.



Note: The installation procedures and screen shots in this section are based on Windows 7 operation system.

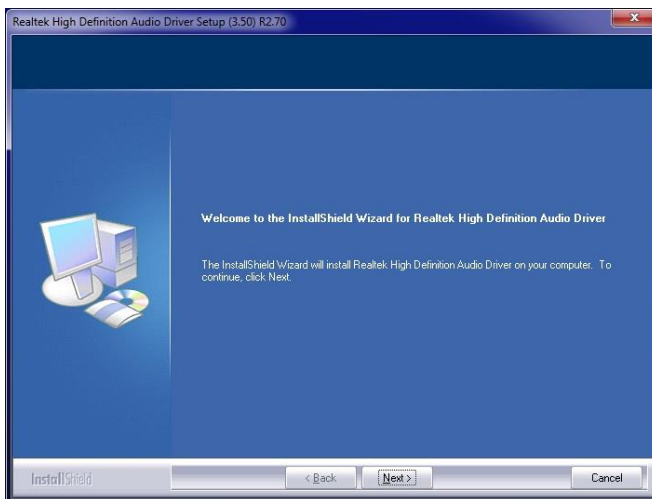

Step 1. Click **Next** to continue setup.

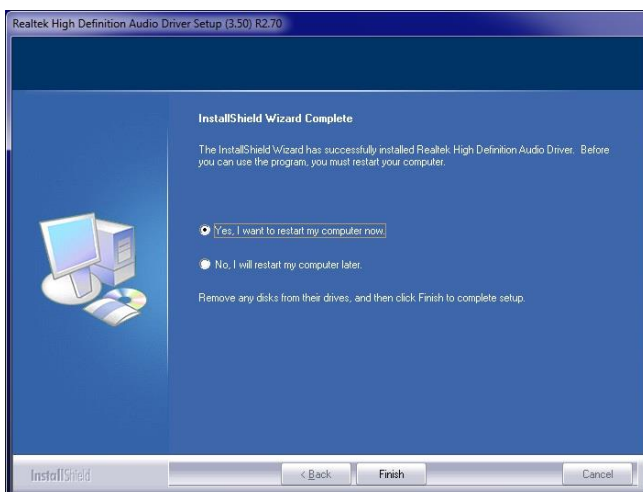

Step 2. Click **Finish** to complete the setup.

4.6 Install Ethernet Driver (For Intel I217LM and I210AT)

Insert the Supporting DVD-ROM to DVD-ROM drive, and it should show the index page of Avalue's products automatically. If not, locate Index.htm and choose the product from the menu left, or link to

\Driver_Gigabit\Intel\ECM-QM87_LAN.



Note: The installation procedures and screen shots in this section are based on Windows 7 operation system.



Step 1. Click **Next**.



Step 2. Click **Next** to accept license agreement.

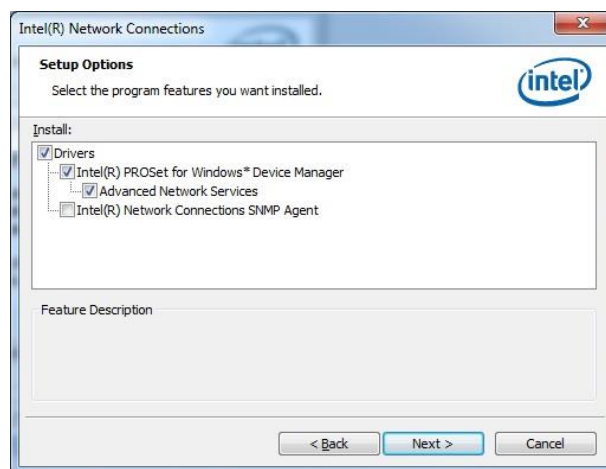

Step 3. Click **Next** after choosing features to install.

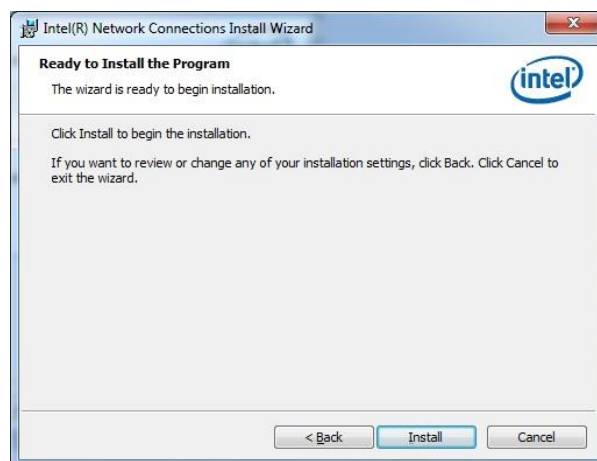

Step 4. Click **Install** to proceed.

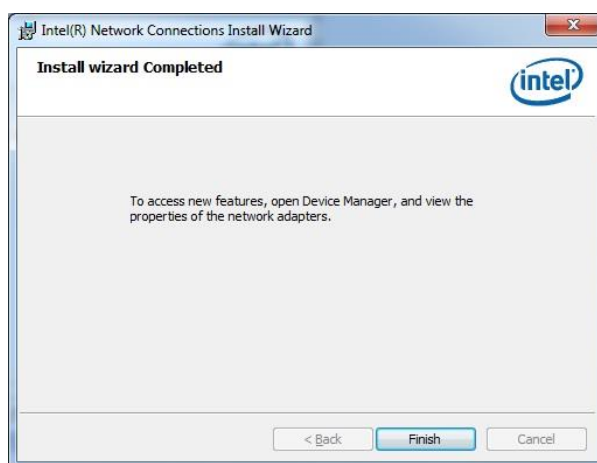

Step 5. Click **Finish** to complete the setup

5. Mechanical Drawing

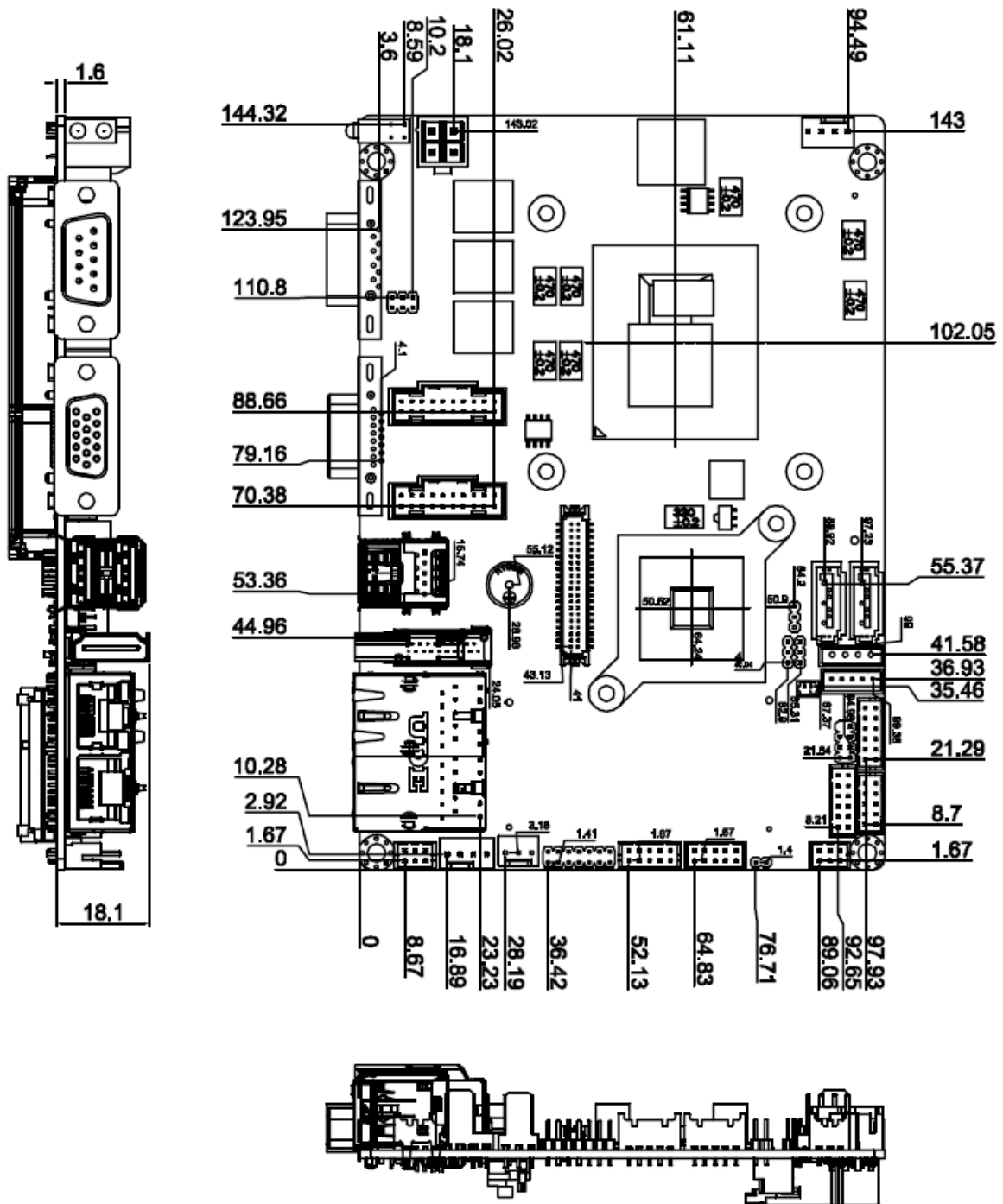

Unit: mm

ECM-QM87R/ ECM-QM87

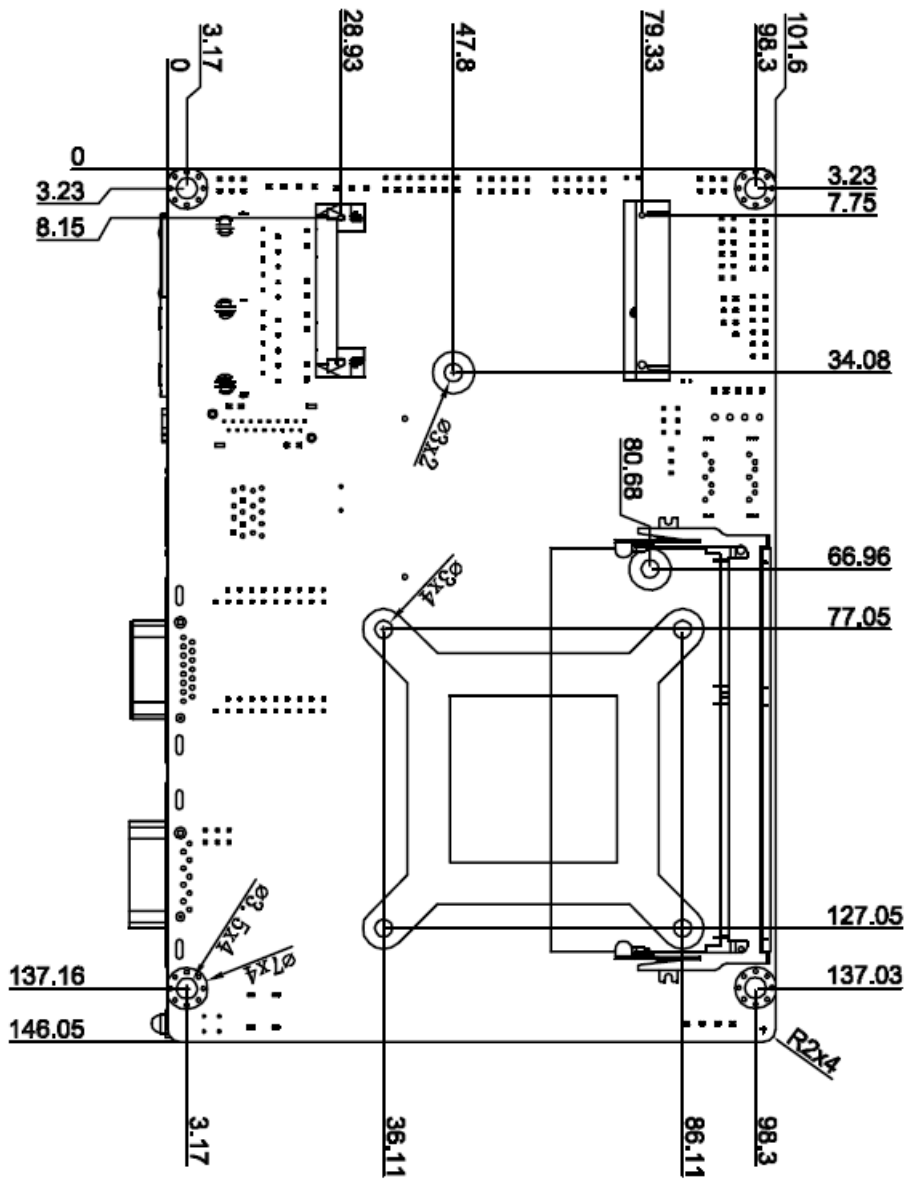

Unit: mm

