

# ECM-PNV

Intel® Atom™ D510 Dual-Core 3.5" Micro Module with Intel® ICH8-M Chipset

## User's Manual



1<sup>st</sup> Ed – 14 July 2010

## FCC Statement



THIS DEVICE COMPLIES WITH PART 15 FCC RULES. OPERATION IS SUBJECT TO THE FOLLOWING TWO CONDITIONS:

(1) THIS DEVICE MAY NOT CAUSE HARMFUL INTERFERENCE.

(2) THIS DEVICE MUST ACCEPT ANY INTERFERENCE RECEIVED INCLUDING INTERFERENCE THAT MAY CAUSE UNDESIRE OPERATION.

THIS EQUIPMENT HAS BEEN TESTED AND FOUND TO COMPLY WITH THE LIMITS FOR A CLASS "A" DIGITAL DEVICE, PURSUANT TO PART 15 OF THE FCC RULES.

THESE LIMITS ARE DESIGNED TO PROVIDE REASONABLE PROTECTION AGAINST HARMFUL INTERFERENCE WHEN THE EQUIPMENT IS OPERATED IN A COMMERCIAL ENVIRONMENT. THIS EQUIPMENT GENERATES, USES, AND CAN RADIATE RADIO FREQUENCY ENERGY AND, IF NOT INSTALLED AND USED IN ACCORDANCE WITH THE INSTRUCTION MANUAL, MAY CAUSE HARMFUL INTERFERENCE TO RADIO COMMUNICATIONS.

OPERATION OF THIS EQUIPMENT IN A RESIDENTIAL AREA IS LIKELY TO CAUSE HARMFUL INTERFERENCE IN WHICH CASE THE USER WILL BE REQUIRED TO CORRECT THE INTERFERENCE AT HIS OWN EXPENSE.

## Notice

This guide is designed for experienced users to setup the system within the shortest time. For detailed information, please always refer to the electronic user's manual.

## Copyright Notice

Copyright © 2010 Avalue Technology Inc., ALL RIGHTS RESERVED.

No part of this document may be reproduced, copied, translated, or transmitted in any form or by any means, electronic or mechanical, for any purpose, without the prior written permission of the original manufacturer.

## Trademark Acknowledgement

Brand and product names are trademarks or registered trademarks of their respective owners.

## Disclaimer

Avalue Technology Inc. reserves the right to make changes, without notice, to any product, including circuits and/or software described or contained in this manual in order to improve design and/or performance. Avalue Technology assumes no responsibility or liability for the use of the described product(s), conveys no license or title under any patent, copyright, or masks work rights to these products, and makes no representations or warranties that these products are free from patent, copyright, or mask work right infringement, unless

otherwise specified. Applications that are described in this manual are for illustration purposes only. Avalue Technology Inc. makes no representation or warranty that such application will be suitable for the specified use without further testing or modification.

### Life Support Policy

Avalue Technology's PRODUCTS ARE NOT FOR USE AS CRITICAL COMPONENTS IN LIFE SUPPORT DEVICES OR SYSTEMS WITHOUT THE PRIOR WRITTEN APPROVAL OF Avalue Technology Inc.

As used herein:

1. Life support devices or systems are devices or systems which, (a) are intended for surgical implant into body, or (b) support or sustain life and whose failure to perform, when properly used in accordance with instructions for use provided in the labeling, can be reasonably expected to result in significant injury to the user.
2. A critical component is any component of a life support device or system whose failure to perform can be reasonably expected to cause the failure of the life support device or system, or to affect its safety or effectiveness.

### A Message to the Customer

#### *Avalue Customer Services*

Each and every Avalue's product is built to the most exacting specifications to ensure reliable performance in the harsh and demanding conditions typical of industrial environments. Whether your new Avalue device is destined for the laboratory or the factory floor, you can be assured that your product will provide the reliability and ease of operation for which the name Avalue has come to be known.

Your satisfaction is our primary concern. Here is a guide to Avalue's customer services. To ensure you get the full benefit of our services, please follow the instructions below carefully.

#### *Technical Support*

We want you to get the maximum performance from your products. So if you run into technical difficulties, we are here to help. For the most frequently asked questions, you can easily find answers in your product documentation. These answers are normally a lot more detailed than the ones we can give over the phone. So please consult the user's manual first.

To receive the latest version of the user's manual; please visit our Web site at:

<http://www.avalue.com.tw/>

## ECM-PNV

If you still cannot find the answer, gather all the information or questions that apply to your problem, and with the product close at hand, call your dealer. Our dealers are well trained and ready to give you the support you need to get the most from your Avalue's products. In fact, most problems reported are minor and are able to be easily solved over the phone. In addition, free technical support is available from Avalue's engineers every business day. We are always ready to give advice on application requirements or specific information on the installation and operation of any of our products. Please do not hesitate to call or e-mail us.

### Headquarters and Branch

#### Avalue Technology Inc.

7F, 228, Lian-cheng Road, Chung Ho City, Taipei, Taiwan

Tel: +886-2-8226-2345

Fax: +886-2-8226-2777

Information: [sales@avalue.com.tw](mailto:sales@avalue.com.tw)

Service: [service@avalue.com.tw](mailto:service@avalue.com.tw)

#### Avalue USA

##### Avalue Technology Inc.

200 Tornillo Way, Suite 210, Tinton Falls,  
NJ 07712

Tel: +1-732-578-0200

Fax: +1-732-578-0250

Information: [sales@avalue-usa.com](mailto:sales@avalue-usa.com)

Service: [support@avalue-usa.com](mailto:support@avalue-usa.com)

#### Avalue Europe

##### Avalue Europe A/S

Moelledalen 22C, 3140

Aalsgaarde, Denmark

Tel: +45-7025-0310

Fax: +45-4975-5026

Information: [sales.europe@avalue.com.tw](mailto:sales.europe@avalue.com.tw)

Service: [service.europe@avalue.com.tw](mailto:service.europe@avalue.com.tw)

#### BCM Advanced Research BCM Advanced Research an Avalue Company

7 Marconi, Irvine, CA92618

Tel: +1-949-470-1888

Fax: +1-949-470-0971

Information: [BCMSales@bcmcom.com](mailto:BCMSales@bcmcom.com)

Web: [www.bcmcom.com](http://www.bcmcom.com)

#### Avalue China

##### Avalue Technology Inc.

Room 805, Building 9, No.99 Tianzhou Rd.,

Caohejing Development Area,

Xuhui District, Shanghai

Tel: +86-21-5169-3609

Fax: +86-21-5445-3266

Information: [sales.china@avalue.com.cn](mailto:sales.china@avalue.com.cn)

Service: [service@avalue.com.tw](mailto:service@avalue.com.tw)

## ***Product Warranty***

Avalue warrants to you, the original purchaser, that each of its products will be free from defects in materials and workmanship for two years from the date of purchase.

This warranty does not apply to any products which have been repaired or altered by persons other than repair personnel authorized by Avalue, or which have been subject to misuse, abuse, accident or improper installation. Avalue assumes no liability under the terms of this warranty as a consequence of such events. Because of Avalue's high quality-control standards and rigorous testing, most of our customers never need to use our repair service. If any of Avalue's products is defective, it will be repaired or replaced at no charge during the warranty period. For out-of-warranty repairs, you will be billed according to the cost of replacement materials, service time, and freight. Please consult your dealer for more details. If you think you have a defective product, follow these steps:

1. Collect all the information about the problem encountered. (For example, CPU type and speed, Avalue's products model name, hardware & BIOS revision number, other hardware and software used, etc.) Note anything abnormal and list any on-screen messages you get when the problem occurs.
2. Call your dealer and describe the problem. Please have your manual, product, and any helpful information available.
3. If your product is diagnosed as defective, obtain an RMA (return material authorization) number from your dealer. This allows us to process your good return more quickly.
4. Carefully pack the defective product, a complete Repair and Replacement Order Card and a photocopy proof of purchase date (such as your sales receipt) in a shippable container. A product returned without proof of the purchase date is not eligible for warranty service.
5. Write the RMA number visibly on the outside of the package and ship it prepaid to your dealer.

# Contents

<b>1. Getting Started</b> .....	<b>10</b>
1.1 Safety Precautions .....	10
1.2 Packing List.....	10
1.3 Document Amendment History .....	11
1.4 Manual Objectives.....	12
1.5 System Specifications .....	13
1.6 Architecture Overview – Block Diagram.....	15
<b>2. Hardware Configuration</b> .....	<b>16</b>
<b>For Rev. A1</b> .....	<b>16</b>
2.1 Product Overview.....	17
2.2 Installation Procedure .....	18
2.2.1 Main Memory.....	19
2.3 Jumper and Connector List.....	21
2.4 Setting Jumpers & Connectors .....	23
2.4.1 Clear CMOS (JBAT).....	23
2.4.2 Serial port 1 pin 9 signal select (JRI1) .....	23
2.4.3 Miscellaneous setting connector (JFP) .....	24
2.4.4 5VSB connector in ATX (PWR_SB).....	24
2.3.4.1 Signal Description –AT/ATX mode & Input power type .....	25
2.4.5 Touch panel mode select (JTOUCH_SEL).....	26
2.4.6 Input power select (POWER_SET) .....	26
2.4.7 Battery connector (BAT).....	27
2.4.8 CPU fan connector (CPU_FAN).....	27
2.4.9 Serial port 1/ 2/ 3 in RS-422/485 mode (J422/485_1/ J422/485_2/ J422/485_3) .....	28
2.4.10 Audio connector (JAUDIO) .....	28
2.4.11 Serial port 2 connector (JCOM2).....	29
2.4.12 Serial port 3/ 4 connector (JCOM3/ JCOM4).....	29
2.4.13 General purpose I/O connector (JDIO).....	30
2.4.14 Touch panel connector (JTOUCH) .....	31
2.4.15 USB connector 2 & 3/ 6 & 7 (JUSB2/ JUSB3).....	31
2.4.16 LVDS connector (JLVDS) .....	32
2.4.17 SATA power connector (S_PWR1).....	32
2.4.18 LCD Inverter Connector (JBKL).....	33
2.4.18.1 Signal Description – LCD Inverter Connector (JBKL) .....	33
2.4.19 LCD backlight brightness adjustment (JVR).....	34
2.4.20 Power connector (PWR).....	34
2.4 Audio / USB Daughter Board User’s Guide.....	35

2.4.1	Jumper and Connector Layout.....	35
2.4.2	Jumper and Connector List.....	35
2.4.3	Setting Jumper and Connector .....	36
<b>3.</b>	<b>Hardware Configuration.....</b>	<b>37</b>
	<b>For Rev. B1.....</b>	<b>37</b>
3.1	Product Overview.....	38
3.2	Installation Procedure .....	39
3.2.1	Main Memory.....	40
3.3	Jumper and Connector List.....	42
3.4	Setting Jumpers & Connectors .....	44
3.4.1	Clear CMOS (JBAT).....	44
3.4.2	Serial port 1 pin 9 signal select (JRI1) .....	44
3.4.3	Touch panel mode select (JTOUCH_SEL).....	45
3.4.4	Input power select (POWER_SET).....	45
3.4.5	Miscellaneous setting connector (JFP).....	46
3.4.6	5VSB connector in ATX (PWR_SB).....	46
3.4.6.1	Signal Description –AT/ ATX mode & Input power type .....	47
3.4.7	Battery connector (BAT).....	48
3.4.8	CPU fan connector (CPU_FAN).....	48
3.4.9	Serial port 1/ 2/ 3 in RS-422/485 mode (J422/485_1/ J422/485_2/ J422/485_3) .....	49
3.4.10	Audio connector (JAUDIO) .....	49
3.4.11	Serial port 2 connector (JCOM2).....	50
3.4.12	Serial port 3/ 4 connector (JCOM3/ JCOM4).....	51
3.4.13	General purpose I/O connector (JDIO).....	52
3.4.14	Touch panel connector (JTOUCH) .....	53
3.4.15	USB connector 2 & 3/ 6 & 7 (JUSB2/ JUSB3).....	53
3.4.16	LVDS connector (HJLVDS1).....	54
3.4.17	LCD Inverter Connector (HJBKL1/ HJBKL2).....	55
3.4.17.1	Signal Description – LCD Inverter Connector (HJBKL1).....	55
3.4.18	LCD backlight brightness adjustment (HJVR) .....	56
3.4.19	Power connector (PWR).....	56
3.4.20	SATA power connector (S_PWR1).....	57
3.5	Audio / USB Daughter Board User's Guide.....	58
3.5.1	Jumper and Connector Layout.....	58
3.5.2	Jumper and Connector List.....	58
3.5.3	Setting Jumper and Connector .....	59
<b>4.</b>	<b>BIOS Setup.....</b>	<b>60</b>
4.1	Introduction .....	61
4.2	Starting Setup .....	61
4.3	Using Setup .....	62

## ECM-PNV

4.4	Getting Help .....	63
4.5	In Case of Problems .....	63
4.6	BIOS setup .....	64
4.6.1	Main Menu .....	64
4.6.1.1	System Date .....	64
4.6.1.2	System Time .....	64
4.6.2	Advanced Menu .....	65
4.6.2.1	CPU Configuration .....	66
4.6.2.2	IDE Configuration .....	67
4.6.2.3	Super IO Configuration .....	68
4.6.2.4	Hardware Health Configuration .....	69
4.6.2.5	ACPI Settings .....	69
4.6.2.5.1	General ACPI Configuration .....	70
4.6.2.5.2	Advanced ACPI Configuration .....	71
4.6.2.5.3	Chipset ACPI Configuration .....	72
4.6.2.6	AHCI Configuration .....	73
4.6.2.6.1	AHCI Port0 .....	74
4.6.2.6.2	AHCI Port1 .....	75
4.6.2.6.3	AHCI Port2 .....	76
4.6.2.7	USB Configuration .....	77
4.6.2.7.1	USB Mass Storage Device Configuration .....	78
4.6.2.8	APM Configuration .....	79
4.6.3	PCI/ PnP .....	80
4.6.4	Boot .....	81
4.6.4.1	Boot settings Configuration .....	82
4.6.4.2	Boot device priority .....	83
4.6.4.3	Hard Disk Drives .....	83
4.6.4.4	Removable Drives .....	84
4.6.5	Security .....	84
4.6.5.1	Change Supervisor/ User Password .....	85
4.6.5.2	Clear User Password .....	86
4.6.5.3	Boot Sector Virus Protection .....	86
4.6.6	Advanced Chipset Settings .....	87
4.6.6.1	North Bridge Configuration .....	88
4.6.6.1.1	Video Function Configuration .....	89
4.6.6.2	South Bridge Configuration .....	91
4.6.7	Exit Options .....	92
4.6.7.1	Save changes and exit .....	92
4.6.7.2	Discard Changes and Exit .....	93
4.6.7.3	Discard Changes .....	93



4.6.7.4	Load Optimal Default.....	94
4.6.7.5	Load Failsafe Defaults.....	94
<b>5.</b>	<b>Drivers Installation.....</b>	<b>95</b>
5.1	Install Display Driver (For Intel QM57).....	96
5.2	Install Audio Driver (For Realtek ALC888).....	97
5.3	Install Ethernet Driver (For Intel 82574L).....	98
<b>6.</b>	<b>Mechanical Drawing .....</b>	<b>100</b>
<b>7.</b>	<b>Mechanical Drawing .....</b>	<b>103</b>

# 1. Getting Started

## 1.1 Safety Precautions

### Warning!



Always completely disconnect the power cord from your chassis whenever you work with the hardware. Do not make connections while the power is on. Sensitive electronic components can be damaged by sudden power surges. Only experienced electronics personnel should open the PC chassis.

### Caution!



Always ground yourself to remove any static charge before touching the CPU card. Modern electronic devices are very sensitive to static electric charges. As a safety precaution, use a grounding wrist strap at all times. Place all electronic components in a static-dissipative surface or static-shielded bag when they are not in the chassis.

## 1.2 Packing List

Before you begin installing your single board, please make sure that the following materials have been shipped:

- 1 x 3.5" ECM-PNV Micro Module
- 1 x Quick Installation Guide for ECM-PNV
- 1 x AUX-032 daughter board
- 1 x DVD-ROM contains the followings:
  - User's Manual (this manual in PDF file)
  - Ethernet driver and utilities
  - VGA drivers and utilities
  - Audio drivers and utilities
- 1 x Cable set contains the followings:
  - 1 x Audio cable (12pin, 2.0mm pitch)
  - 2 x USB cable (10P/2.54mm-10P/2.0mm)
  - 1 x Serial ATA cable (7-pin, standard)
  - 1 x Serial ATA cable (15-pin, 2P/2.0mm)
- 1 x CPU & North Bridge Cooler



---

If any of the above items is damaged or missing, contact your retailer.

---

### 1.3 Document Amendment History

Revision	Date	Comment
1 <sup>st</sup>	July 2010	Initial Release

### 1.4 Manual Objectives

This manual describes in detail the Avalue Technology ECM-PNV Single Board.

We have tried to include as much information as possible but we have not duplicated information that is provided in the standard IBM Technical References, unless it proved to be necessary to aid in the understanding of this board.

We strongly recommend that you study this manual carefully before attempting to interface with ECM-PNV series or change the standard configurations. Whilst all the necessary information is available in this manual we would recommend that unless you are confident, you contact your supplier for guidance.



Please be aware that it is possible to create configurations within the CMOS RAM that make booting impossible. If this should happen, clear the CMOS settings, (see the description of the Jumper Settings for details).

If you have any suggestions or find any errors concerning this manual and want to inform us of these, please contact our Customer Service department with the relevant details.

## 1.5 System Specifications

System	
CPU	Intel® Atom™ D510 Dual-Core 1.66GHz CPU or D410/ N450 1.66GHz CPU (Optional)
FSB	533/ 667 MHz
BIOS	AMI 8Mbit Flash BIOS
System Chipset	Intel® ICH8-M
I/O Chip	ITE 8712F-KX
System Memory	One 200-pin SODIMM Supports Up to 2GB DDR2 667 SDRAM
SSD	One CompactFlash Type I/II Socket
Watchdog Timer	Reset: 1sec. ~ 65535min. and 1sec. or 1min./step
Expansion	1 x Mini PCIe Card
I/O	
MIO	2 x SATA, 4 x RS-232, 2 x RS-422/ 485, 1 x KB & Mouse (Optional)
USB	6 x USB 2.0
DIO	16-bit General Purpose I/O for DI and DO
Display	
Chipset	Intel® Pineview Integrated, GMA3150 @ 400MHz (PNV D510/ D410) Intel® Pineview Integrated, GMA500 @ 200MHz (PNV N450)
Resolution	VGA Mode : Up to 2048 x 1536 @ 60Hz (PNV D510/D410) VGA Mode : Up to 1400 x 1050 @ 60Hz (PNV N450)
Multiple Display	CRT + LVDS
LCD Interface	Signal 18-bit LVDS for Rev. A1 Dual-channel 24-bit LVDS Via Daughter Board for Rev. B1
Audio	
Chipset	Intel® ICH8-M
AC97 Codec	Realtek ALC888 Supports 5.1-CH HD Audio
Audio Interface	Mic-in, Line-in, Line-out

## ECM-PNV

<b>Ethernet</b> 	
<b>LAN</b>	Dual Intel® 82574L Gigabit Ethernet
<b>Ethernet Interface</b>	1000 Base-Tx Gigabit Ethernet Compatible
<b>Mechanical &amp; Environmental</b> 	
<b>Power Requirement</b>	+12V ~ +28V
<b>Power Type</b>	Single Power AT/ ATX
<b>Operation Temperature</b>	0 ~ 60°C (32 ~ 140°F)
<b>Operating Humidity</b>	0% ~ 90% Relative Humidity, Non-condensing
<b>Size ( L x W )</b>	5.7" x 4" (146mm x 101mm)
<b>Weight</b>	0.44lbs (0.2kg)

## 1.6 Architecture Overview – Block Diagram

The following block diagram shows the architecture and main components of ECM-PNV.

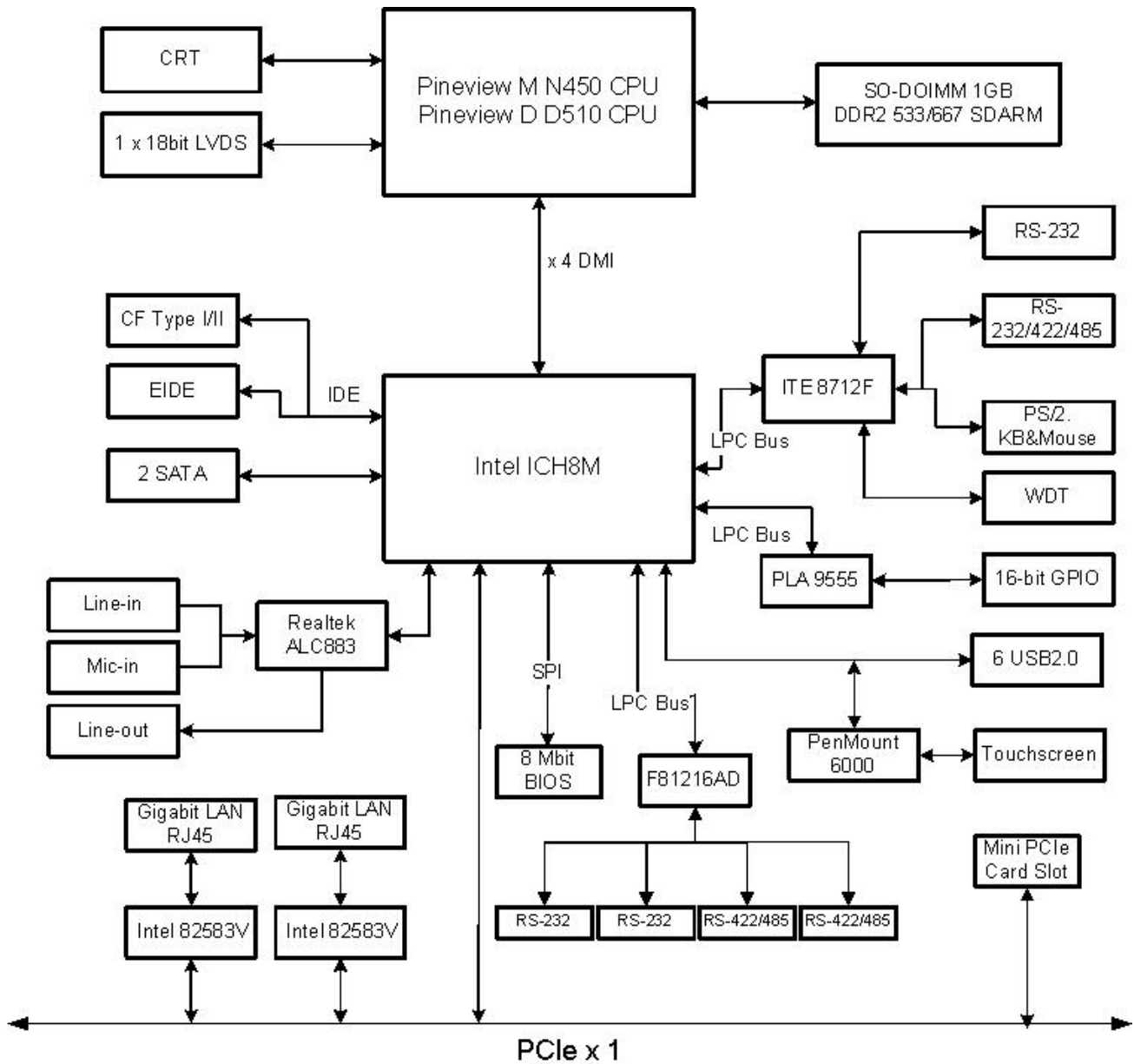

# 2. Hardware Configuration

For Rev. A1





## 2.1 Product Overview

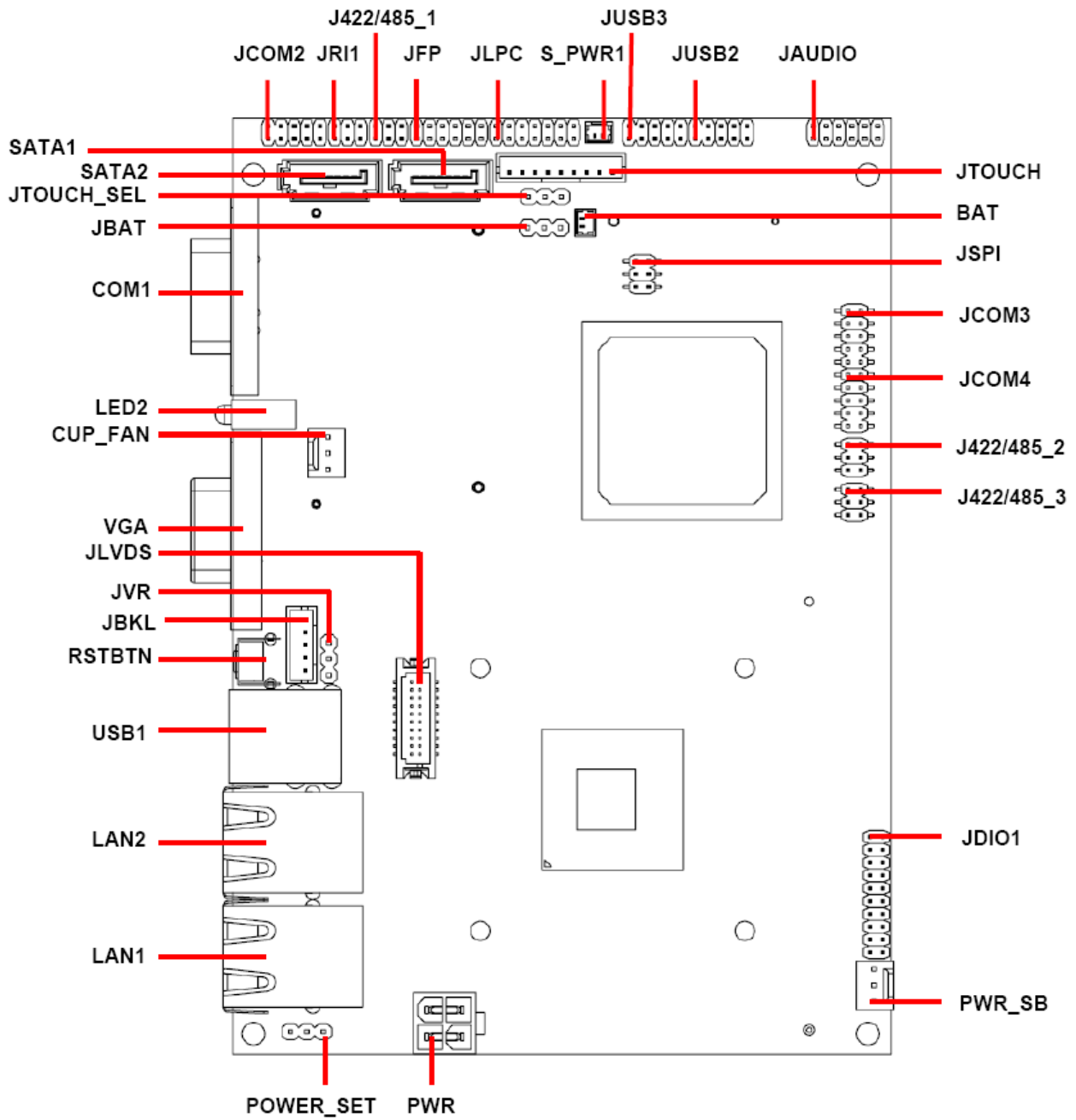

## 2.2 Installation Procedure

This chapter explains you the instructions of how to setup your system.

1. Turn off the power supply.
2. Insert the SODIMM module (be careful with the orientation).
3. Insert all external cables for hard disk, floppy, keyboard, mouse, USB etc. except for flat panel. A CRT monitor must be connected in order to change CMOS settings to support flat panel.
4. Connect power supply to the board via the ATXPWR.
5. Turn on the power.
6. Enter the BIOS setup by pressing the delete key during boot up. Use the "LOAD BIOS DEFAULTS" feature. The **Integrated Peripheral Setup** and the **Standard CMOS Setup** Window must be entered and configured correctly to match the particular system configuration.
7. If TFT panel display is to be utilized, make sure the panel voltage is correctly set before connecting the display cable and turning on the power.



**Note:** Make sure the heat sink and the CPU top surface are in total contact to avoid CPU overheating problem that would cause the system to hang or unstable

### 2.2.1 Main Memory

ECM-PNV provides one 200-pin SODIMM socket support up to DDR2 667 SDRAM. The total maximum memory size is 2GB.

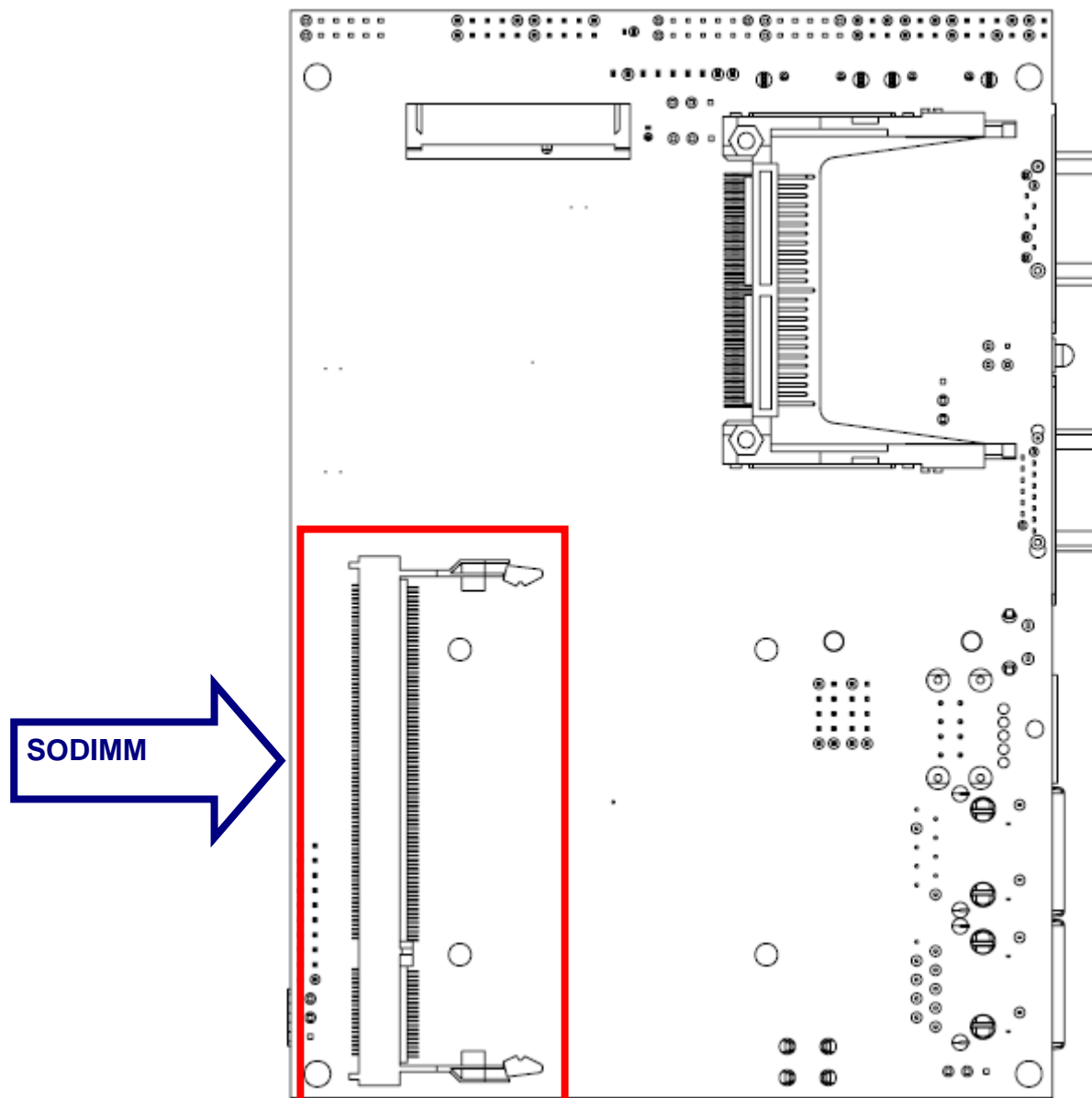

(Rear side)



Make sure to unplug the power supply before adding or removing SODIMMs or other system components. Failure to do so may cause severe damage to both the board and the components.

- Locate the SODIMM socket on the board.
- Hold two edges of the SODIMM module carefully. Keep away of touching its connectors.

## ECM-PNV

- Align the notch key on the module with the rib on the slot.
- Firmly press the modules into the socket automatically snaps into the mounting notch. Do not force the SODIMM module in with extra force as the SODIMM module only fit in one direction.

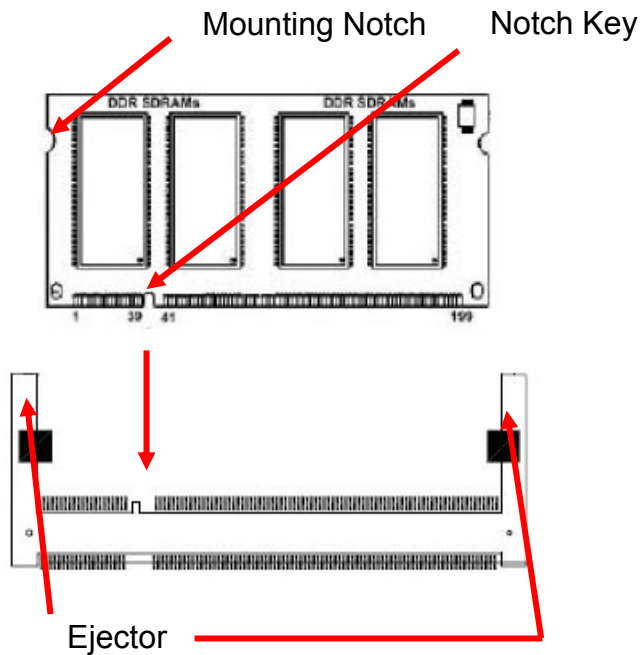

### 200-pin DDR2 SODIMM

- To remove the SODIMM modules, push the two ejector tabs on the slot outward simultaneously, and then pull out the SODIMM module.



#### Note:

- (1) Please do not change any DDR3 SDRAM parameter in BIOS setup to increase your system's performance without acquiring technical information in advance.
- (2) Static electricity can damage the electronic components of the computer or optional boards. Before starting these procedures, ensure that you are discharged of static electricity by touching a grounded metal object briefly.

## 2.3 Jumper and Connector List

You can configure your board to match the needs of your application by setting jumpers. A jumper is the simplest kind of electric switch.

It consists of two metal pins and a small metal clip (often protected by a plastic cover) that slides over the pins to connect them. To “close” a jumper you connect the pins with the clip. To “open” a jumper you remove the clip. Sometimes a jumper will have three pins, labeled 1, 2, and 3. In this case, you would connect either two pins.

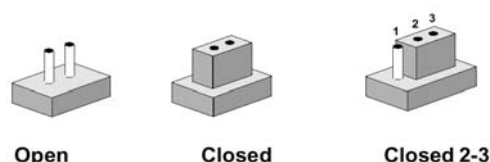

The jumper settings are schematically depicted in this manual as follows:



A pair of needle-nose pliers may be helpful when working with jumpers.

Connectors on the board are linked to external devices such as hard disk drives, a keyboard, or floppy drives. In addition, the board has a number of jumpers that allow you to configure your system to suit your application.

If you have any doubts about the best hardware configuration for your application, contact your local distributor or sales representative before you make any changes.

The following tables list the function of each of the board's jumpers and connectors.

### Jumpers

Label	Function	Note
<b>JBAT</b>	Clear CMOS	3 x 1 header, pitch 2.54 mm
<b>JFP</b>	Miscellaneous setting connector	6 x 2 header, pitch 2.0 mm
<b>JRI1</b>	Serial port 1 pin 9 signal select	3 x 2 header, pitch 2.0 mm
<b>JTOUCH_SEL</b>	Touch panel mode select	3 x 1 header, pitch 2.54 mm
<b>POWER_SET</b>	Input power select	3 x 1 header, pitch 2.54 mm

## Connectors

Label	Function	Note
<b>BAT</b>	Battery connector	2 x 1 wafer, pitch 1.25 mm
<b>COM1</b>	Serial port 1 connector	D-sub 9-pin, male
<b>CPU_FAN</b>	CPU fan connector	3 x 1 wafer, pitch 2.54 mm
<b>J422/485_1</b>	Serial port 1 in RS-422/485 mode	3 x 2 header, pitch 2.0 mm
<b>J422/485_2</b>	Serial port 2 in RS-422/485 mode	3 x 2 header, pitch 2.0 mm
<b>J422/485_3</b>	Serial port 3 in RS-422/485 mode	3 x 2 header, pitch 2.0 mm
<b>JTOUCH</b>	Touch panel connector	9 x 1 header, pitch 2.0 mm
<b>JAUDIO</b>	Audio connector	6 x 2 header, pitch 2.0 mm
<b>JCOM2</b>	Serial port 2 connector	5 x 2 header, pitch 2.0 mm
<b>JCOM3</b>	Serial port 3 connector	5 x 2 header, pitch 2.0 mm
<b>JCOM4</b>	Serial port 4 connector	5 x 2 header, pitch 2.0 mm
<b>JDIO</b>	General purpose I/O connector	10 x 2 header, pitch 2.0 mm
<b>JLPC</b>	(Reserved for debug)	7 x 2 header, pitch 2.0 mm
<b>JUSB2</b>	USB connector 2 & 3	5 x 2 header, pitch 2.0 mm
<b>JUSB3</b>	USB connector 6 & 7	5 x 2 header, pitch 2.0 mm
<b>JLVDS</b>	LVDS connector	2 x 10 header, pitch 1.25mm
<b>JVR</b>	LCD backlight brightness adjustment	3 x 1 header, pitch 2.54mm
<b>JBKL</b>	LCD inverter connector	5 x 1 wafer, pitch 2.0mm
<b>LAN1</b>	RJ-45 Ethernet connector	
<b>LAN2</b>	RJ-45 Ethernet connector	
<b>LED2</b>	LED connector	
<b>PWR</b>	Power connector	2 x 2 wafer, pitch 4.2 mm
<b>PWR_SB</b>	5VSB connector in ATX	3 x 1 wafer, pitch 2.54 mm
<b>S_PWR1</b>	SATA power connector	2 x 1 wafer, pitch 2.0 mm
<b>SATA1</b>	Serial ATA connector 1	
<b>SATA2</b>	Serial ATA connector 2	
<b>RSTBTN</b>	Reset button	
<b>USB1</b>	USB connector 0 & 1	Double Deck
<b>VGA</b>	VGA connector	D-sub 15-pin, female

## 2.4 Setting Jumpers & Connectors

### 2.4.1 Clear CMOS (JBAT)

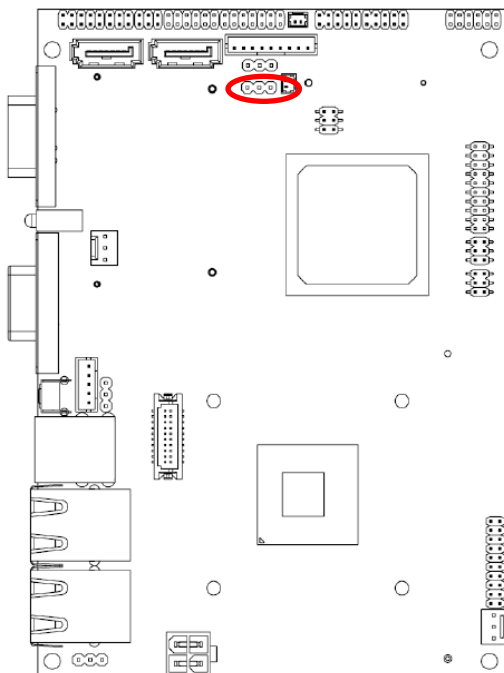

Protect\*

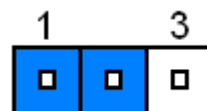

Clear CMOS

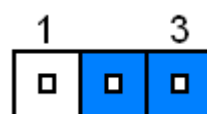

\* Default

### 2.4.2 Serial port 1 pin 9 signal select (JRI1)

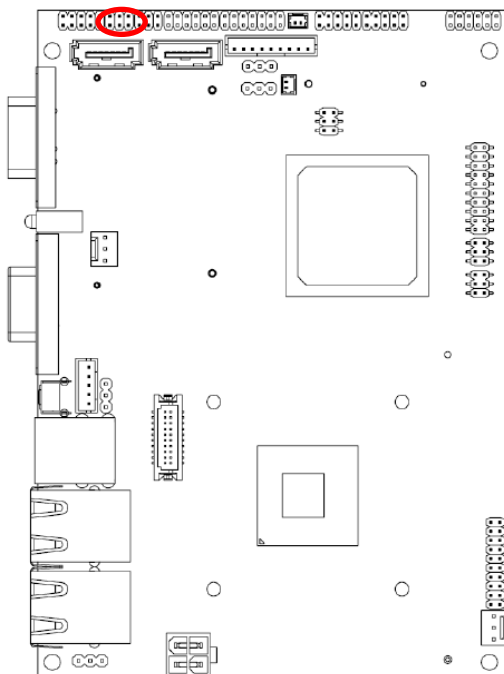

Ring\*

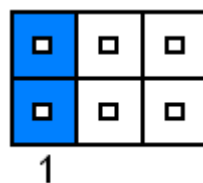

+5V

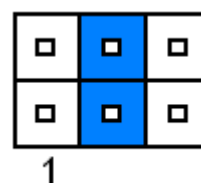

+12V

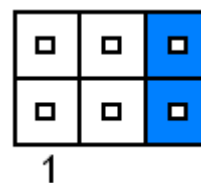

\* Default

## ECM-PNV

### 2.4.3 Miscellaneous setting connector (JFP)

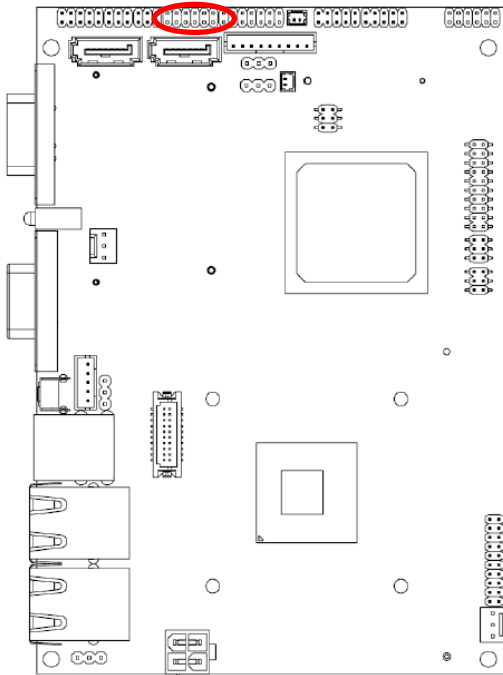

\* Default

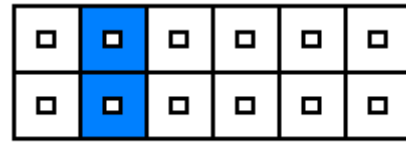

Signal	PIN	
PWBT	1	
	2	
PWR MSEL	3	
	4	
PWR-LED	+	5
	-	6
HDD-LED	-	7
	+	8
CF SEL	9	
	Short Slave	10
COPEN#	11	
	12	

### 2.4.4 5VSB connector in ATX (PWR\_SB)

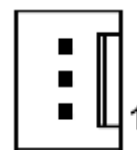
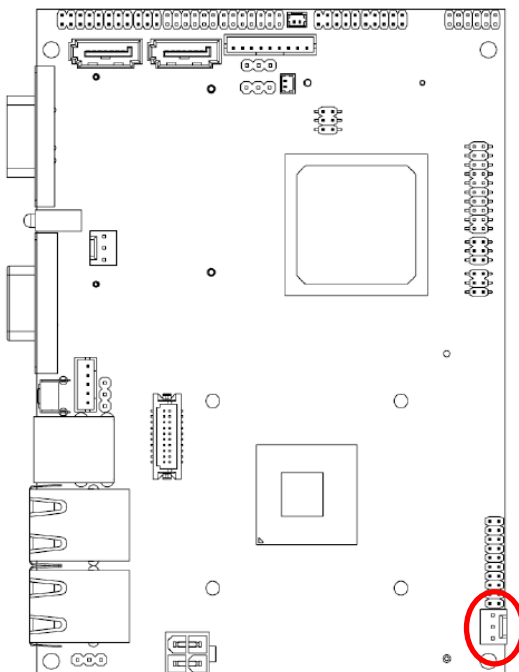

Signal	PIN
ATX5VSB	3
GND	2
PSON	1

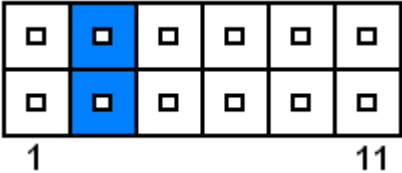
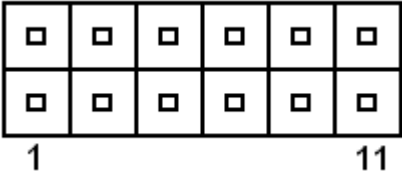
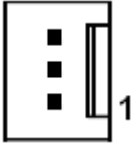
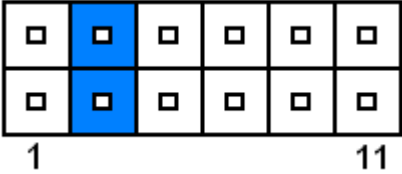
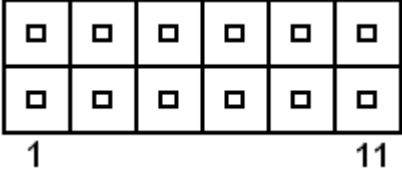

2.3.4.1 Signal Description –AT/ATX mode & Input power type

Input power type	Power-ON Mode	Description
<p>AT Type</p>	<p><b>AT Mode</b> (PWR MSEL)</p> 	<p>Use AT type power input, and set the board in AT mode.</p>
	<p><b>ATX Mode</b> (PWR MSEL)</p> 	<p>Use AT type power input, and set the board in ATX mode.</p>
<p>ATX Type (PWR_SB)</p> 	<p><b>AT Mode</b> (PWR MSEL)</p> 	<p>Use ATX type power input, and set the board in AT mode.</p>
	<p><b>ATX Mode</b> (PWR MSEL)</p> 	<p>Use ATX type power input, and set the board in ATX mode.</p>

# ECM-PNV

## 2.4.5 Touch panel mode select (JTOUCH\_SEL)

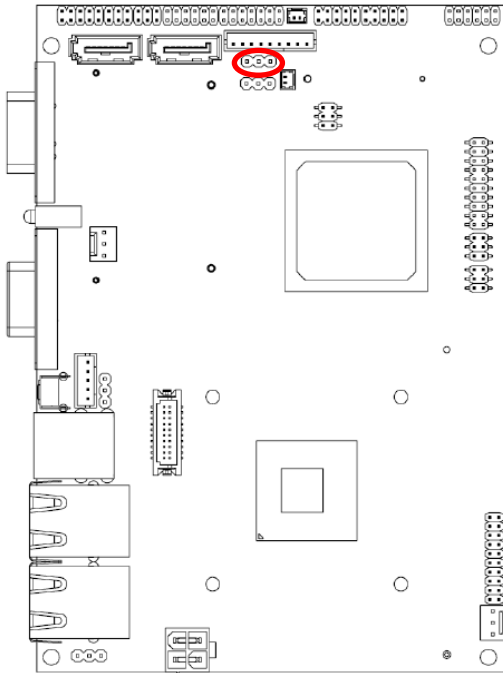

4/ 8W

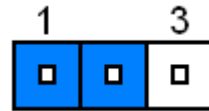

5W\*

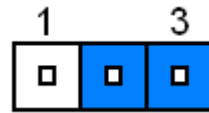

\* Default

## 2.4.6 Input power select (POWER\_SET)

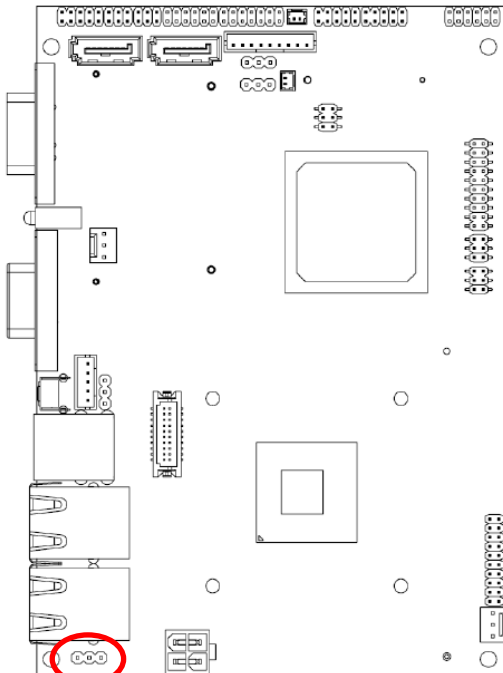

15V~24V Input

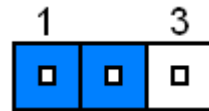

14V~12V Input\*

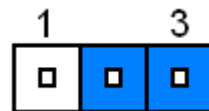

\* Default

### 2.4.7 Battery connector (BAT)

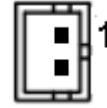
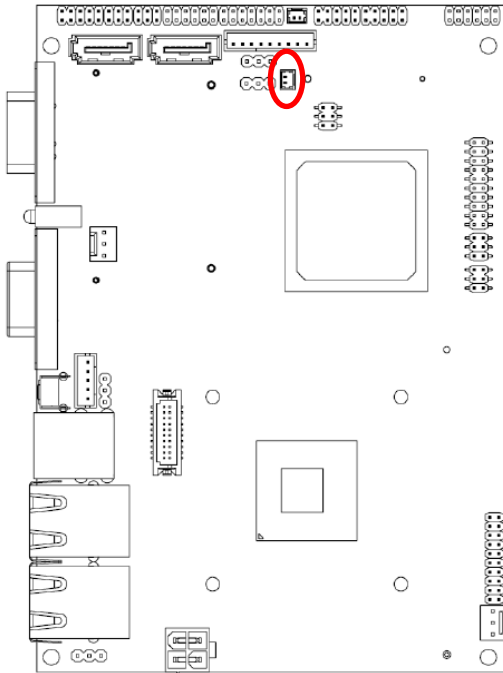

Signal	PIN
BAT	1
GND	2

### 2.4.8 CPU fan connector (CPU\_FAN)

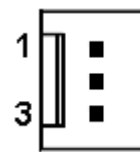
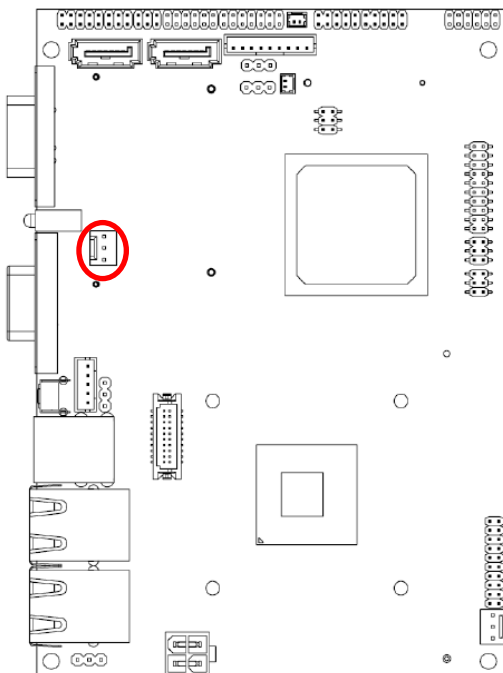

Signal	PIN
GND	1
+12V	2
FAN_TAC1	3

## ECM-PNV

### 2.4.9 Serial port 1/ 2/ 3 in RS-422/485 mode (J422/485\_1/ J422/485\_2/ J422/485\_3)

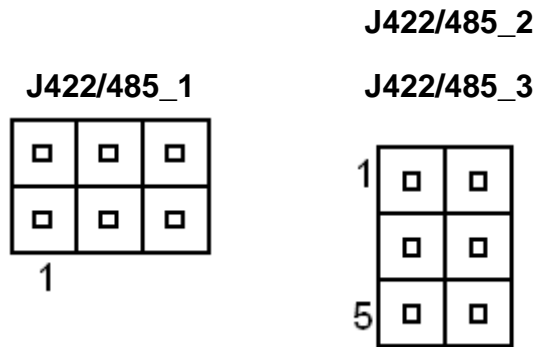
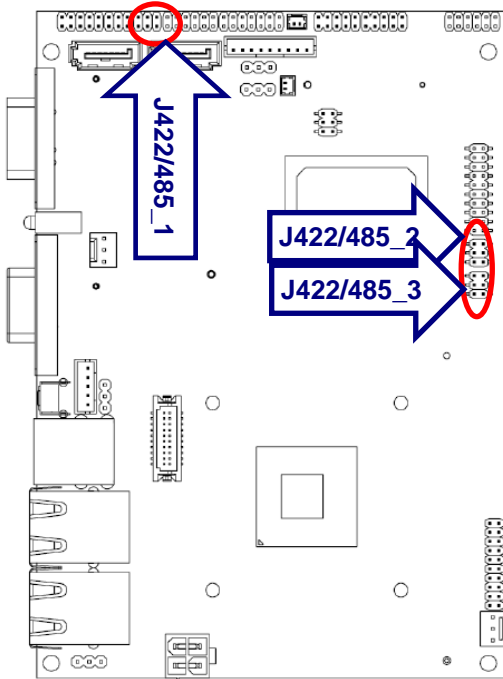

Signal	PIN	PIN	Signal
TX-	1	2	RX-
TX+	3	4	RX+
+5V	5	6	GND



Note:

J422/485 is available after modifying the mode of COM2 in BIOS setting.

### 2.4.10 Audio connector (JAUDIO)

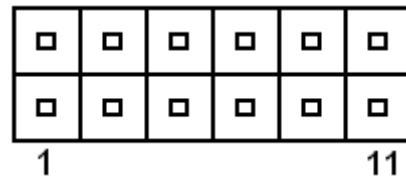
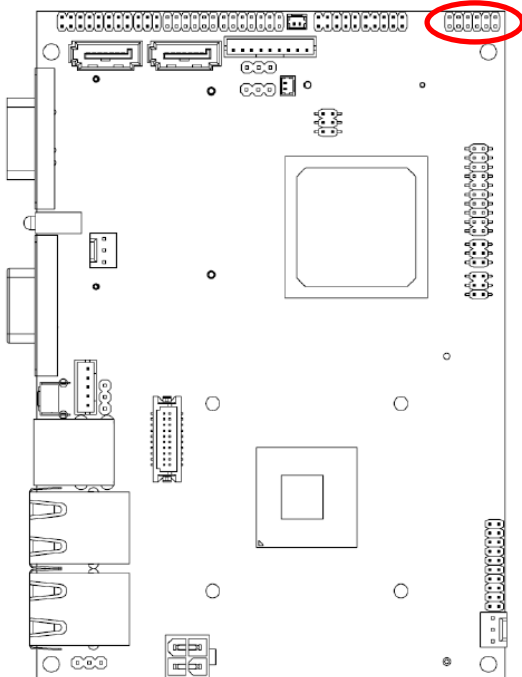

Signal	PIN	PIN	Signal
LINEOUT_R	1	2	LINEOUT_L
GND	3	4	GND
LINEIN_R	5	6	LINEIN_L
MIC-R	7	8	MIC-L
FRONT-JD	9	10	LINE1-JD
MIC1-JD	11	12	GND

### 2.4.11 Serial port 2 connector (JCOM2)

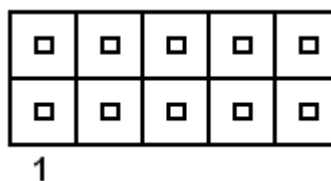
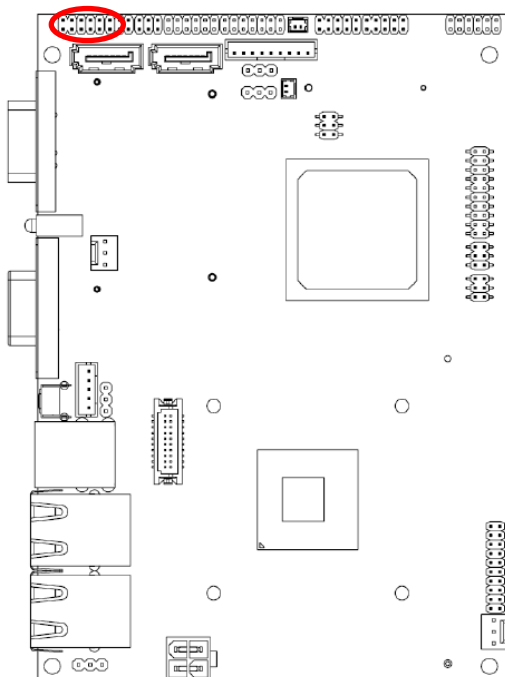

Signal	PIN	PIN	Signal
DCD	1	2	RxD
TxD	3	4	DTR
GND	5	6	DSR
RTS	7	8	CTS
RI	9	10	NC

### 2.4.12 Serial port 3/ 4 connector (JCOM3/ JCOM4)

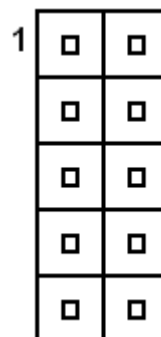
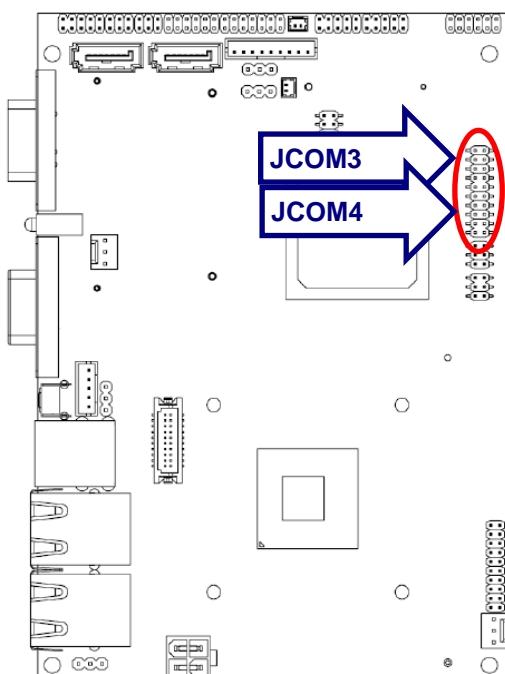

Signal	PIN	PIN	Signal
DCD	1	2	RxD
TxD	3	4	DTR
GND	5	6	DSR
RTS	7	8	CTS
RI	9	10	NC

# ECM-PNV

## 2.4.13 General purpose I/O connector (JDIO)

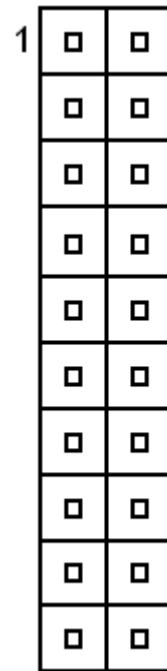
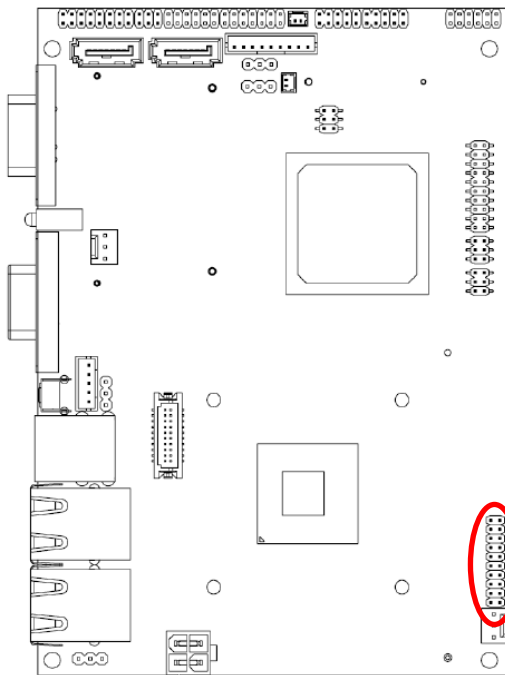

Signal	PIN	PIN	Signal
DIO0	1	2	DIO10
DIO1	3	4	DIO11
DIO2	5	6	DIO12
DIO3	7	8	DIO13
DIO4	9	10	DIO14
DIO5	11	12	DIO15
DIO6	13	14	DIO16
DIO7	15	16	DIO17
SMB_CLK	17	18	SMB_DATA
GND	19	20	+5V

### 2.4.14 Touch panel connector (JTOUCH)

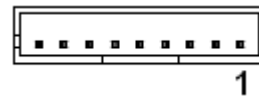
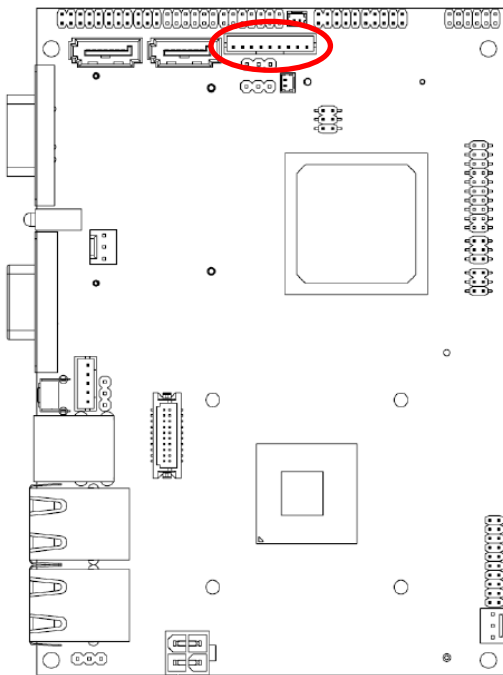

PIN	4-WIRE	5-WIRE	8-WIRE
1	N/A	N/A	Right Sense
2	N/A	N/A	Left Sense
3	N/A	N/A	Bottom Sense
4	N/A	Sense	Top Sense
5	Right	LR	Right Excite
6	Left	LL	Left Excite
7	Bottom	UR	Bottom Excite
8	Top	UL	Top Excite
9	GND	GND	GND

### 2.4.15 USB connector 2 & 3/ 6 & 7 (JUSB2/ JUSB3)

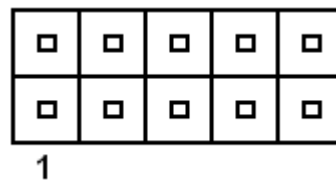
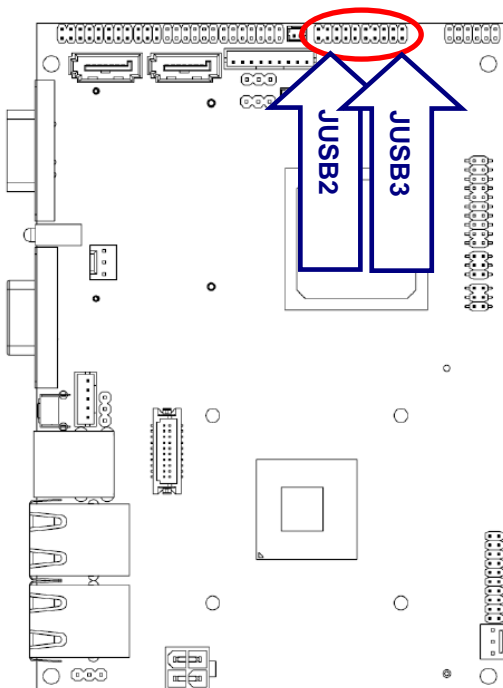

Signal	PIN	PIN	Signal
+5V	1	2	GND
N3/ N7	3	4	GND
P3/ P7	5	6	P2/ P6
GND	7	8	N2/ N6
GND	9	10	+5V

## ECM-PNV

### 2.4.16 LVDS connector (JLVDS)

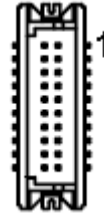
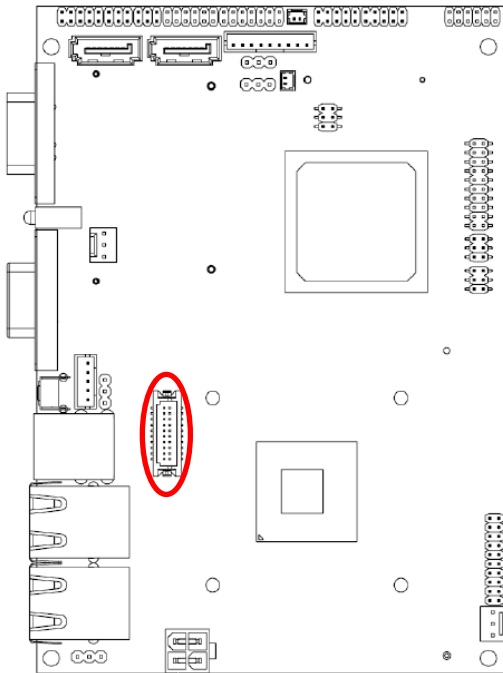

Signal	PIN	PIN	Signal
GND	2	1	GND
LVDS_0-	4	3	LVDS_0+
LVDS_1-	6	5	LVDS_1+
LVDS_2-	8	7	LVDS_2+
NC	10	9	NC
LVDS_CLK-	12	11	LVDS_CLK+
GND	14	13	GND
I_SCL	16	15	I_SDA
+5V	18	17	+3.3V
+5V	20	19	+3.3V

### 2.4.17 SATA power connector (S\_PWR1)

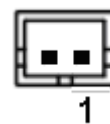
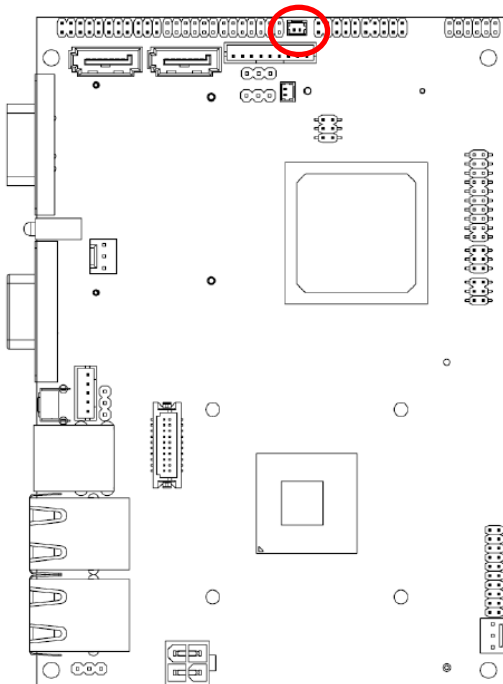

Signal	PIN
SATA_PWR	2
GND	1



#### Note:

SATA\_PWR is +5V for SATA DOM uses.



## 2.4.18 LCD Inverter Connector (JBKL)

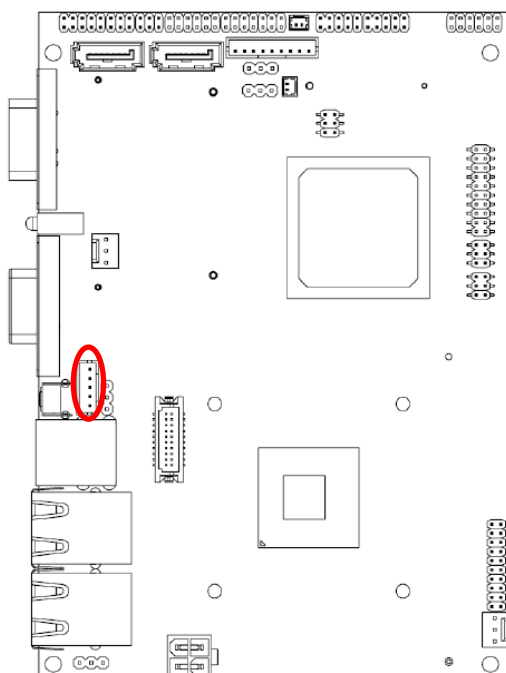

Signal	PIN
+12V	1
GND	2
BLK_ON	3
BRIGHT	4
+5V	5



**Note:**

For inverters with adjustable Backlight function, it is possible to control the LCD brightness through the VR signal controlled by JVR. Please see the JVR section for detailed circuitry information.

### 2.4.18.1 Signal Description – LCD Inverter Connector (JBKL)

Signal	Signal Description
BRIGHT	Vadj = 0.75V ~ 4.25V (Recommended: 4.7KΩ, >1/16W)
BKL_ON	LCD backlight ON/OFF control signal

# ECM-PNV

## 2.4.19 LCD backlight brightness adjustment (JVR)

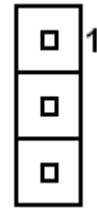
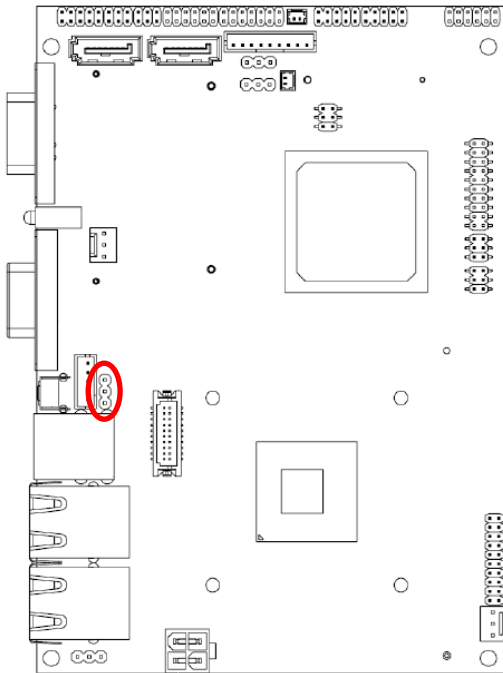

Signal	PIN
+5V	1
BRIGHT	2
GND	3

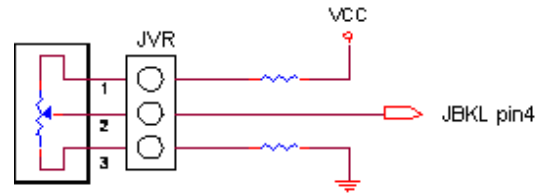

Variation Resistor

(Recommended: 4.7KΩ, >1/16W)

## 2.4.20 Power connector (PWR)

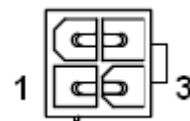
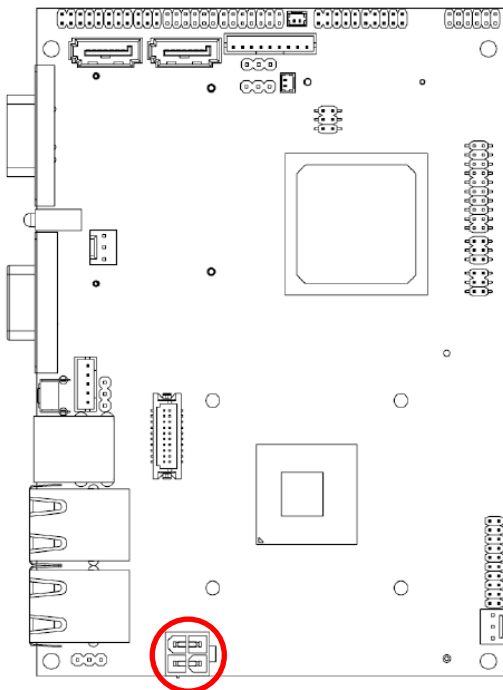

Signal	PIN	PIN	Signal
GND	2	4	VIN
GND	1	3	VIN

## 2.4 Audio / USB Daughter Board User's Guide

### 2.4.1 Jumper and Connector Layout

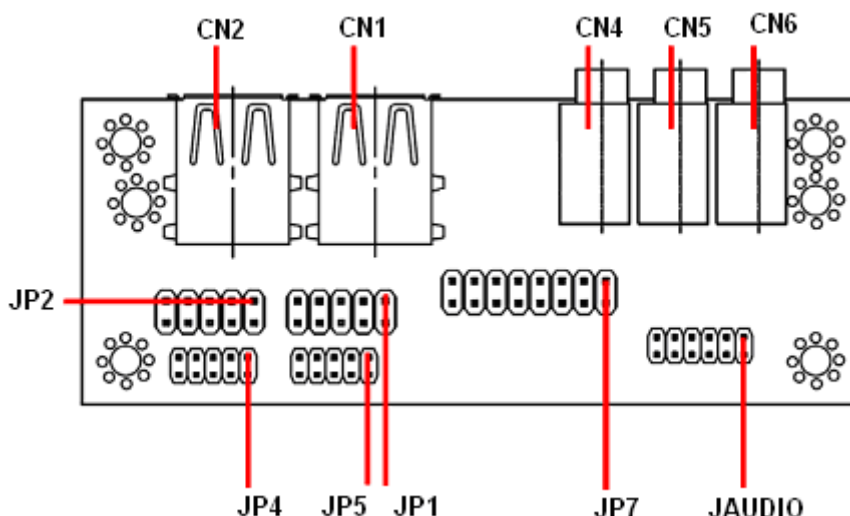

### 2.4.2 Jumper and Connector List

#### Connectors

Label	Function	Note
CN1, CN2	USB connector	
CN4	Line out connector	Phone Jack
CN5	Line in connector	Phone Jack
CN6	Mic in connector	Phone Jack
JAUDIO	Audio connector	6 x 2 header, pitch 2.0mm
JP1	2.54mm USB connector	5 x 2 header, pitch 2.54mm
JP2	2.54mm USB connector	5 x 2 header, pitch 2.54mm
JP4	2.0mm USB connector	5 x 2 header, pitch 2.0mm
JP5	2.0mm USB connector	5 x 2 header, pitch 2.0mm
JP7	TV / Audio connector	8 x 2 header, pitch 2.54mm

## ECM-PNV

### 2.4.3 Setting Jumper and Connector

#### Audio Connector (JAUDIO)

Signal	PIN	PIN	Signal
OUTR	1	2	OUTL
GND	3	4	GND
INR1	5	6	INL1
MICIN1	7	8	AREF
FRONT-JD1	9	10	LINE1-JD1
MIC1-JD1	11	12	GND

#### 2.54mm USB Connector (JP1)

Signal	PIN	PIN	Signal
+5V	1	2	GND
D1-	3	4	GND
D1+	5	6	D2+
GND	7	8	D2-
GND	9	10	+5V



**Note:** Wrong USB cable configuration with your USB devices might cause your USB devices damaged.

#### 2.54mm USB Connector (JP2)

Signal	PIN	PIN	Signal
+5V	1	2	GND
D3-	3	4	GND
D3+	5	6	D4+
GND	7	8	D4-
GND	9	10	+5V

#### TV / Audio Connector (JP7)

Signal	PIN	PIN	Signal
Mic In	1	2	Mic Bais
GND	3	4	GND
Line out L	5	6	Line out R
SPK L	7	8	SPK R
Line in L	9	10	Line in R
GND	11	12	NC
TVGND	13	14	NC
TVGND	15	16	COMP

#### 2.0mm USB Connector (JP4)

Signal	PIN	PIN	Signal
+5V	1	2	GND
D3-	3	4	GND
D3+	5	6	D4+
GND	7	8	D4-
GND	9	10	+5V

#### 2.0mm USB Connector (JP5)

Signal	PIN	PIN	Signal
+5V	1	2	GND
D1-	3	4	GND
D1+	5	6	D2+
GND	7	8	D2-
GND	9	10	+5V

# 3. Hardware Configuration

For Rev. B1



### 3.1 Product Overview

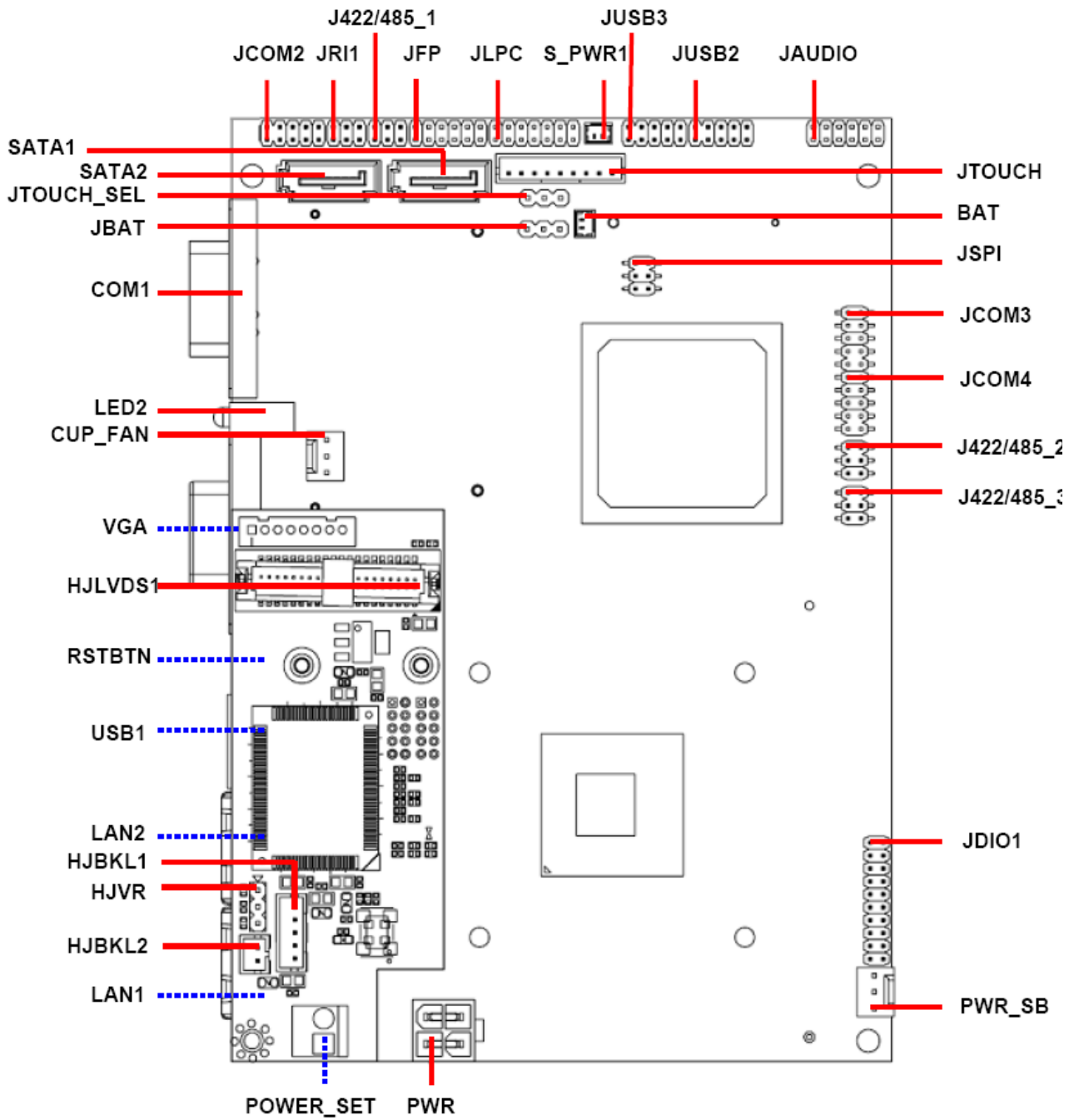

## 3.2 Installation Procedure

This chapter explains you the instructions of how to setup your system.

Turn off the power supply.

- 1 Insert the SODIMM module (be careful with the orientation).
- 2 Insert all external cables for hard disk, floppy, keyboard, mouse, USB etc. except for flat panel. A CRT monitor must be connected in order to change CMOS settings to support flat panel.
- 3 Connect power supply to the board via the ATXPWR.
- 4 Turn on the power.
- 5 Enter the BIOS setup by pressing the delete key during boot up. Use the "LOAD BIOS DEFAULTS" feature. The Integrated Peripheral Setup and the Standard CMOS Setup Window must be entered and configured correctly to match the particular system configuration.
- 6 If TFT panel display is to be utilized, make sure the panel voltage is correctly set before connecting the display cable and turning on the power.



**Note:** Make sure the heat sink and the CPU top surface are in total contact to avoid CPU overheating problem that would cause the system to hang or unstable

## ECM-PNV

### 3.2.1 Main Memory

ECM-PNV provides one 200-pin SODIMM socket support up to DDR2 667 SDRAM. The total maximum memory size is 2GB.

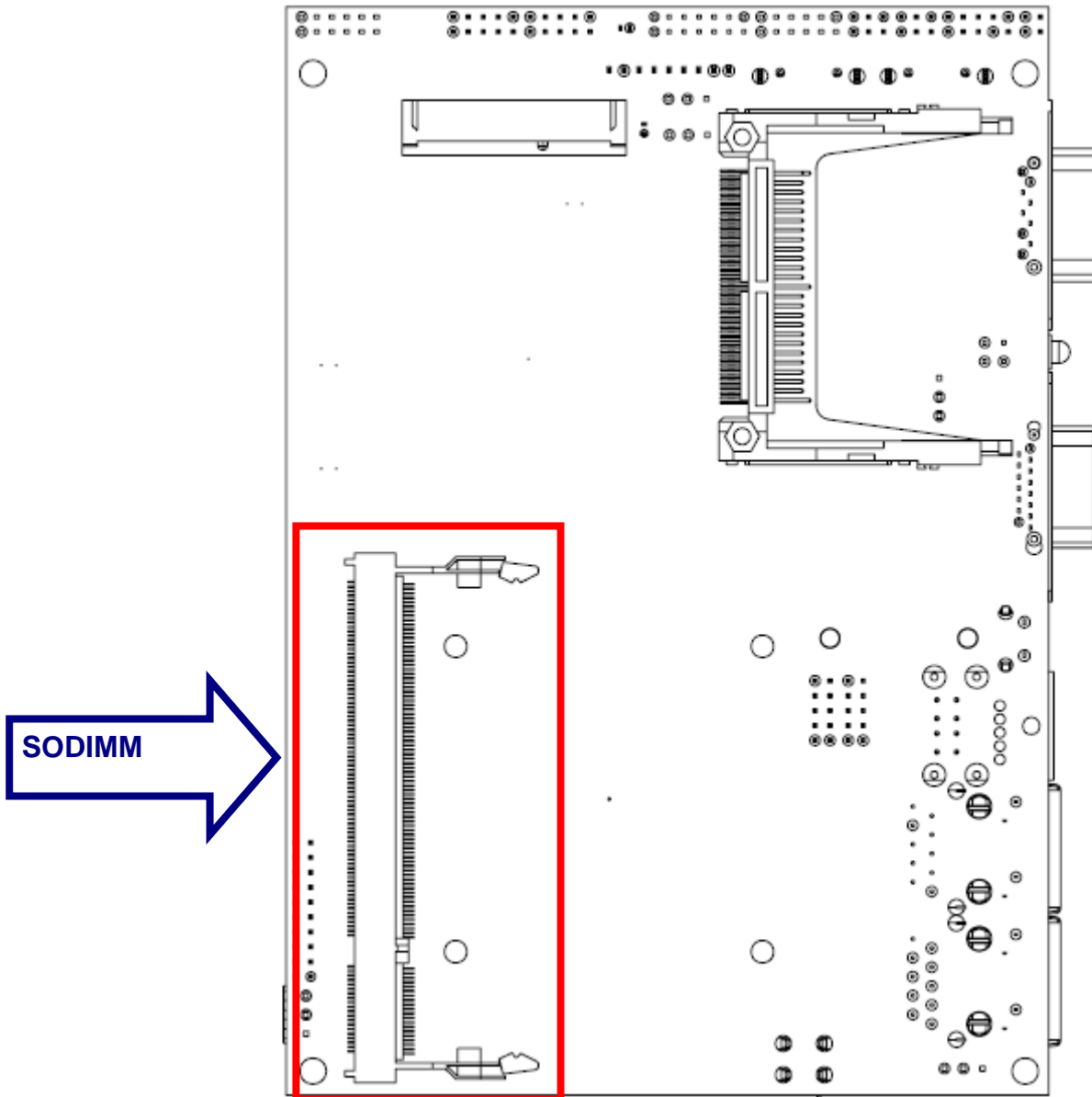

(Rear side)



Make sure to unplug the power supply before adding or removing SODIMMs or other system components. Failure to do so may cause severe damage to both the board and the components.

- Locate the SODIMM socket on the board.
- Hold two edges of the SODIMM module carefully. Keep away of touching its connectors.



- Align the notch key on the module with the rib on the slot.
- Firmly press the modules into the socket automatically snaps into the mounting notch. Do not force the SODIMM module in with extra force as the SODIMM module only fit in one direction.

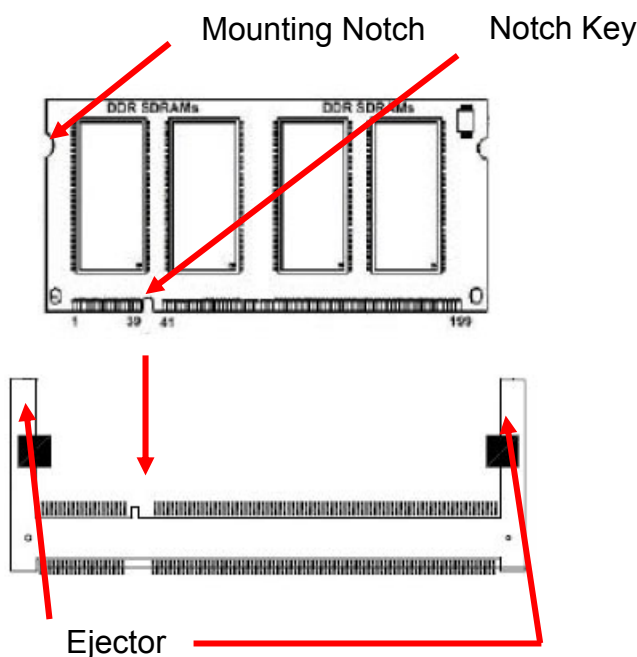

### 200-pin DDR2 SODIMM

- To remove the SODIMM modules, push the two ejector tabs on the slot outward simultaneously, and then pull out the SODIMM module.



#### Note:

- (3) Please do not change any DDR3 SDRAM parameter in BIOS setup to increase your system's performance without acquiring technical information in advance.
- (4) Static electricity can damage the electronic components of the computer or optional boards. Before starting these procedures, ensure that you are discharged of static electricity by touching a grounded metal object briefly.

### 3.3 Jumper and Connector List

You can configure your board to match the needs of your application by setting jumpers. A jumper is the simplest kind of electric switch.

It consists of two metal pins and a small metal clip (often protected by a plastic cover) that slides over the pins to connect them. To “close” a jumper you connect the pins with the clip. To “open” a jumper you remove the clip. Sometimes a jumper will have three pins, labeled 1, 2, and 3. In this case, you would connect either two pins.

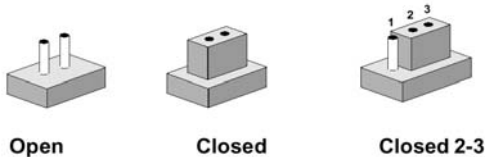

The jumper settings are schematically depicted in this manual as follows:



A pair of needle-nose pliers may be helpful when working with jumpers. Connectors on the board are linked to external devices such as hard disk drives, a keyboard, or floppy drives. In addition, the board has a number of jumpers that allow you to configure your system to suit your application.

If you have any doubts about the best hardware configuration for your application, contact your local distributor or sales representative before you make any changes.

The following tables list the function of each of the board’s jumpers and connectors.

<b>Jumpers</b>		
<b>Label</b>	<b>Function</b>	<b>Note</b>
<b>JBAT</b>	Clear CMOS	3 x 1 header, pitch 2.54 mm
<b>JFP</b>	Miscellaneous setting connector	6 x 2 header, pitch 2.0 mm
<b>JRI1</b>	Serial port 1 pin 9 signal select	3 x 2 header, pitch 2.0 mm
<b>JTOUCH_SEL</b>	Touch panel mode select	3 x 1 header, pitch 2.54 mm
<b>POWER_SET</b>	Input power select	3 x 1 header, pitch 2.54 mm

## Connectors

Label	Function	Note
<b>BAT</b>	Battery connector	2 x 1 wafer, pitch 1.25 mm
<b>COM1</b>	Serial port 1 connector	D-sub 9-pin, male
<b>CPU_FAN</b>	CPU fan connector	3 x 1 wafer, pitch 2.54 mm
<b>J422/485_1</b>	Serial port 1 in RS-422/485 mode	3 x 2 header, pitch 2.0 mm
<b>J422/485_2</b>	Serial port 2 in RS-422/485 mode	3 x 2 header, pitch 2.0 mm
<b>J422/485_3</b>	Serial port 3 in RS-422/485 mode	3 x 2 header, pitch 2.0 mm
<b>JTOUCH</b>	Touch panel connector	9 x 1 header, pitch 2.0 mm
<b>JAUDIO</b>	Audio connector	6 x 2 header, pitch 2.0 mm
<b>JCOM2</b>	Serial port 2 connector	5 x 2 header, pitch 2.0 mm
<b>JCOM3</b>	Serial port 3 connector	5 x 2 header, pitch 2.0 mm
<b>JCOM4</b>	Serial port 4 connector	5 x 2 header, pitch 2.0 mm
<b>JDIO</b>	General purpose I/O connector	10 x 2 header, pitch 2.0 mm
<b>JLPC</b>	(Reserved for debug)	7 x 2 header, pitch 2.0 mm
<b>JUSB2</b>	USB connector 2 & 3	5 x 2 header, pitch 2.0 mm
<b>JUSB3</b>	USB connector 6 & 7	5 x 2 header, pitch 2.0 mm
<b>HJLVDS1</b>	LVDS connector	2 x 20 header, pitch 1.25mm
<b>HJVR</b>	LCD backlight brightness adjustment	3 x 1 header, pitch 2.54mm
<b>HJBKL1</b>	LCD inverter connector	5 x 1 wafer, pitch 2.0mm
<b>HJBKL2</b>	LCD inverter connector	2 x 1 wafer, pitch 2.0mm
<b>LAN1</b>	RJ-45 Ethernet connector	
<b>LAN2</b>	RJ-45 Ethernet connector	
<b>LED2</b>	LED connector	
<b>PWR</b>	Power connector	2 x 2 wafer, pitch 4.2 mm
<b>PWR_SB</b>	5VSB connector in ATX	3 x 1 wafer, pitch 2.54 mm
<b>S_PWR1</b>	SATA power connector	2 x 1 wafer, pitch 2.0 mm
<b>SATA1</b>	Serial ATA connector 1	
<b>SATA2</b>	Serial ATA connector 2	
<b>RSTBTN</b>	Reset button	
<b>USB1</b>	USB connector 0 & 1	Double Deck
<b>VGA</b>	VGA connector	D-sub 15-pin, female

### 3.4 Setting Jumpers & Connectors

#### 3.4.1 Clear CMOS (JBAT)

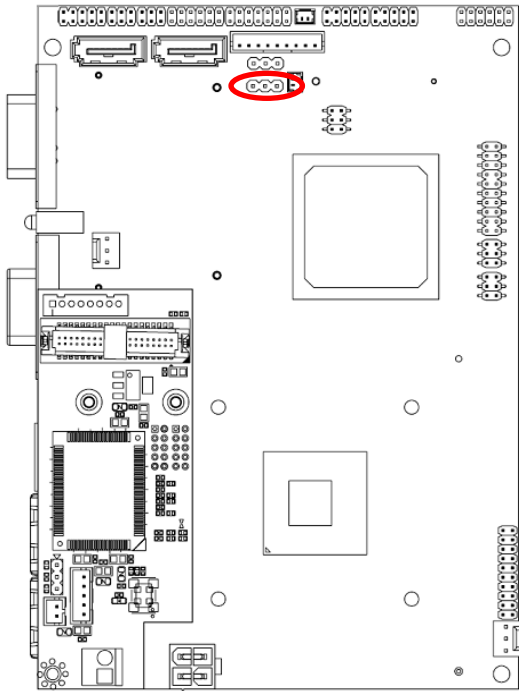

Protect\*

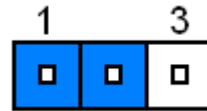

Clear CMOS

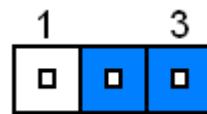

\* Default

#### 3.4.2 Serial port 1 pin 9 signal select (JRI1)

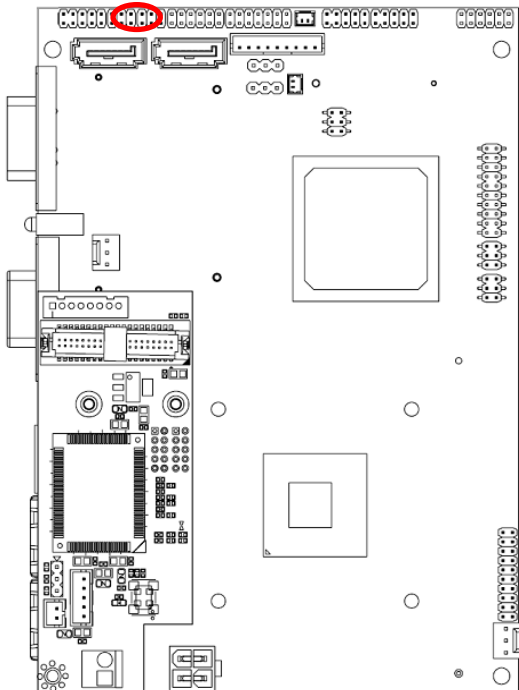

Ring\*

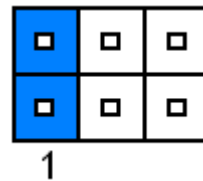

+5V

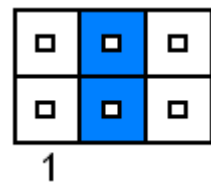

+12V

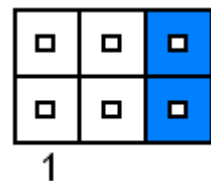

\* Default

### 3.4.3 Touch panel mode select (JTOUCH\_SEL)

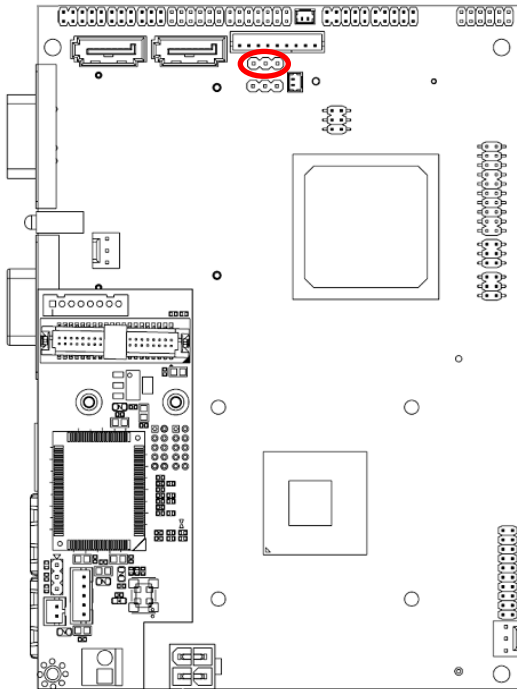

4/ 8W

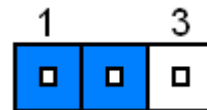

5W\*

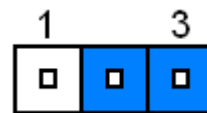

\* Default

### 3.4.4 Input power select (POWER\_SET)

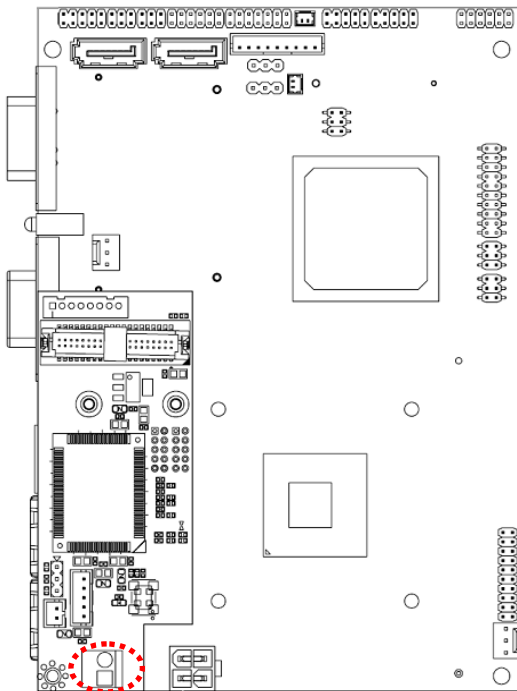

15V~24V Input

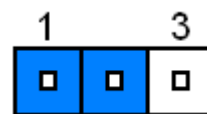

14V~12V Input\*

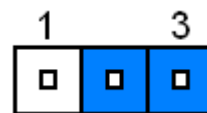

\* Default

# ECM-PNV

## 3.4.5 Miscellaneous setting connector (JFP)

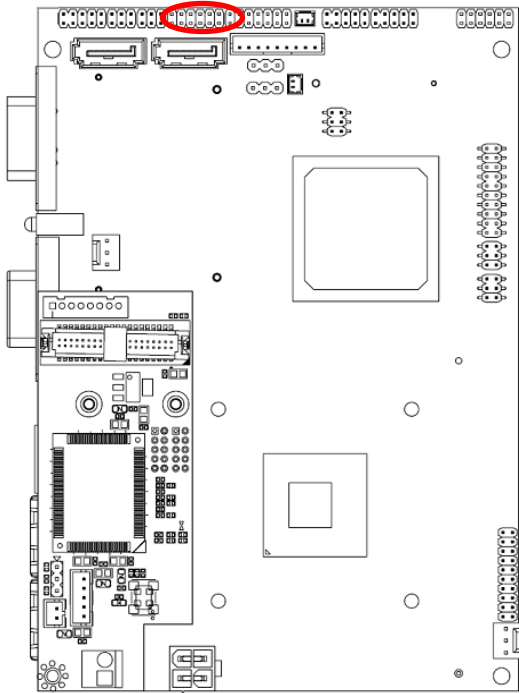

\* Default

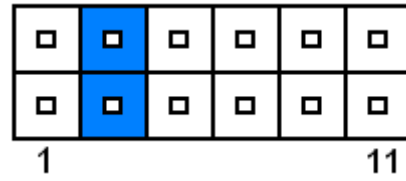

Signal	PIN
PWBT	1
	2
PWR MSEL	3
	4
PWR-LED	+ 5
	- 6
HDD-LED	- 7
	+ 8
CF SEL Short Slave	9
	10
COPEN#	11
	12

## 3.4.6 5VSB connector in ATX (PWR\_SB)

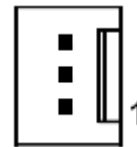
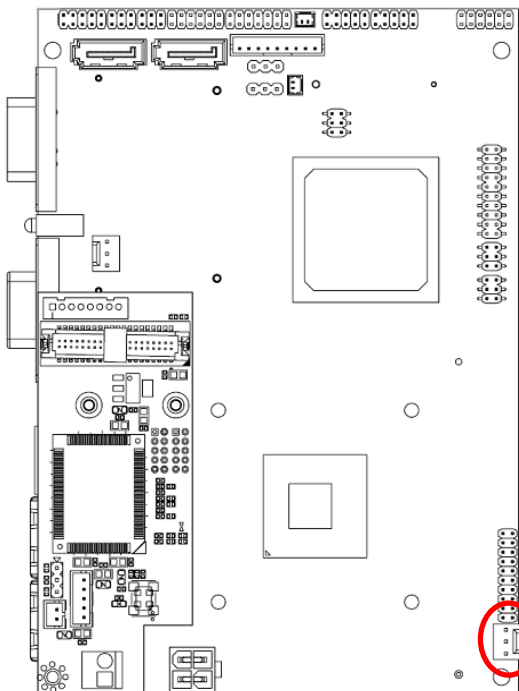

Signal	PIN
ATX5VSB	3
GND	2
PSON	1

3.4.6.1 Signal Description –AT/ ATX mode & Input power type

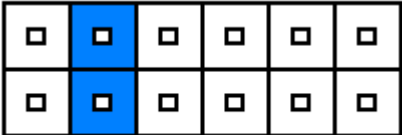
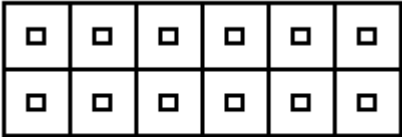
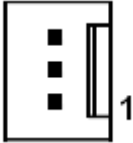
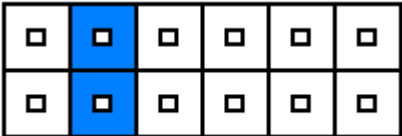
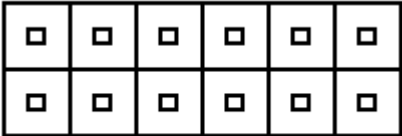
Input power type	Power-ON Mode	Description
<p>AT Type</p>	<p>AT Mode (PWR MSEL)</p>  <p>1 11</p>	<p>Use AT type power input, and set the board in AT mode.</p>
	<p>ATX Mode (PWR MSEL)</p>  <p>1 11</p>	<p>Use AT type power input, and set the board in ATX mode.</p>
<p>ATX Type (PWR_SB)</p> 	<p>AT Mode (PWR MSEL)</p>  <p>1 11</p>	<p>Use ATX type power input, and set the board in AT mode.</p>
	<p>ATX Mode (PWR MSEL)</p>  <p>1 11</p>	<p>Use ATX type power input, and set the board in ATX mode.</p>

# ECM-PNV

## 3.4.7 Battery connector (BAT)

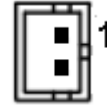
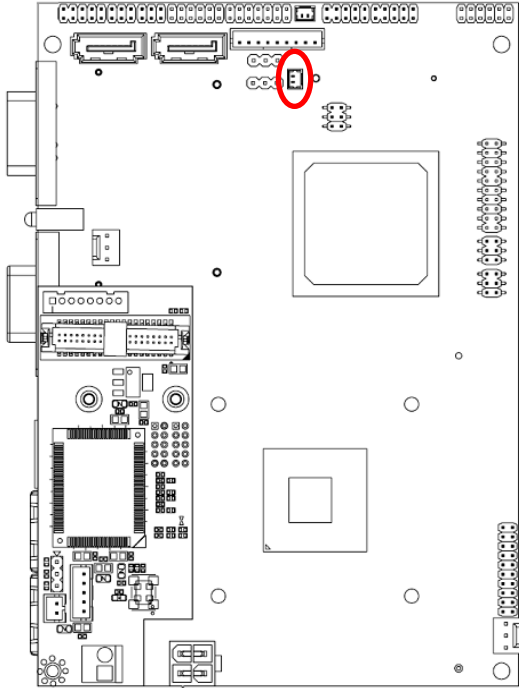

Signal	PIN
BAT	1
GND	2

## 3.4.8 CPU fan connector (CPU\_FAN)

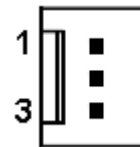
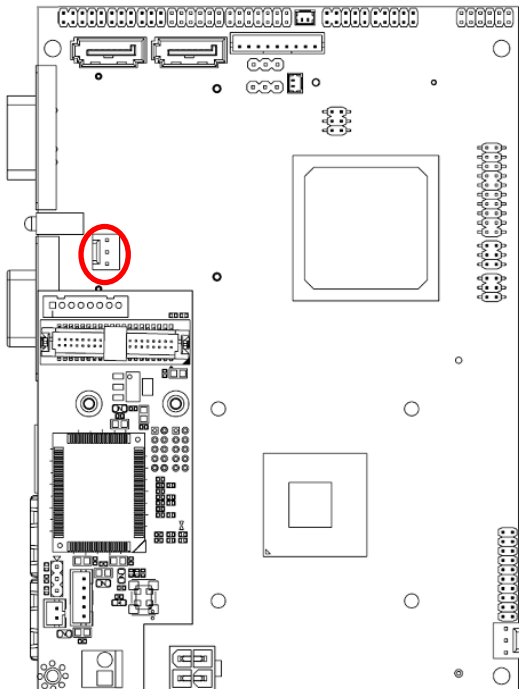

Signal	PIN
GND	1
+12V	2
FAN_TAC1	3



### 3.4.9 Serial port 1/ 2/ 3 in RS-422/485 mode (J422/485\_1/ J422/485\_2/ J422/485\_3)

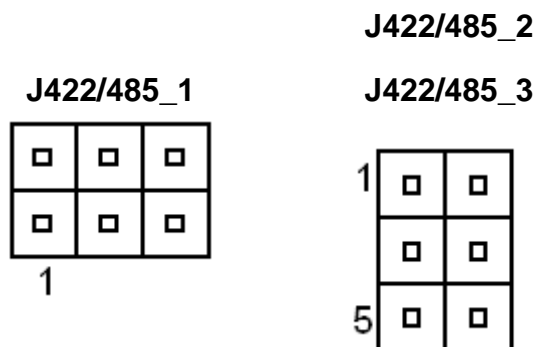
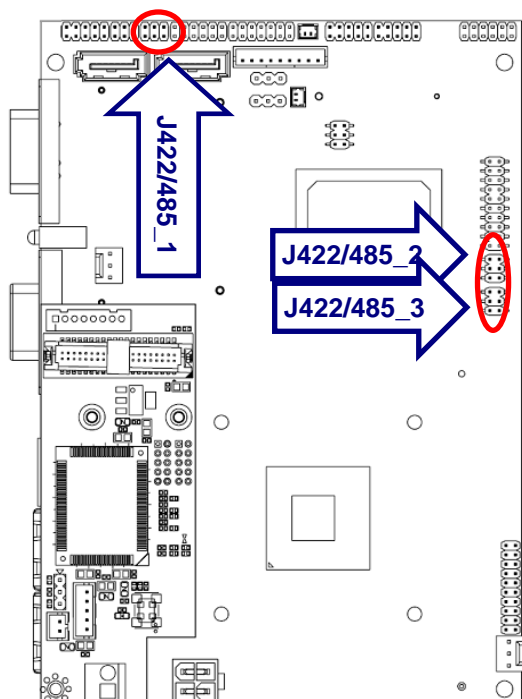

Signal	PIN	PIN	Signal
TX-	1	2	RX-
TX+	3	4	RX+
+5V	5	6	GND



Note:

J422/485 is available after modifying the mode of COM2 in BIOS setting.

### 3.4.10 Audio connector (JAUDIO)

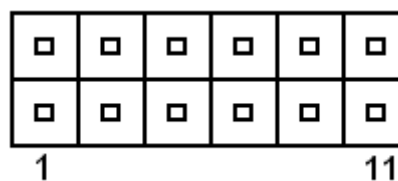
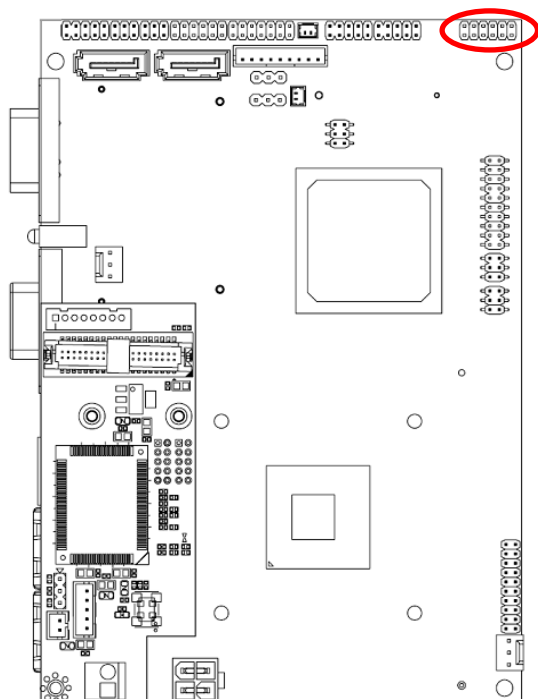

Signal	PIN	PIN	Signal
LINEOUT_R	1	2	LINEOUT_L
GND	3	4	GND
LINEIN_R	5	6	LINEIN_L
MIC-R	7	8	MIC-L
FRONT-JD	9	10	LINE1-JD
MIC1-JD	11	12	GND

# ECM-PNV

## 3.4.11 Serial port 2 connector (JCOM2)

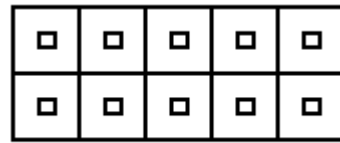
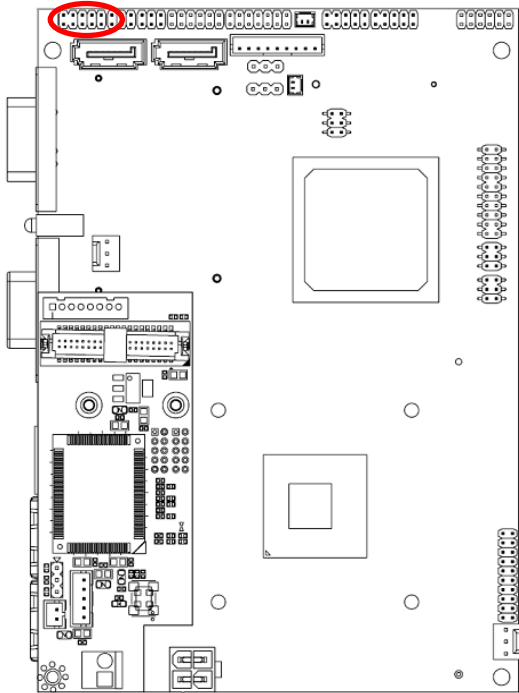

1

Signal	PIN	PIN	Signal
DCD	1	2	RxD
TxD	3	4	DTR
GND	5	6	DSR
RTS	7	8	CTS
RI	9	10	NC

### 3.4.12 Serial port 3/ 4 connector (JCOM3/ JCOM4)

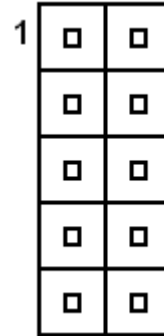
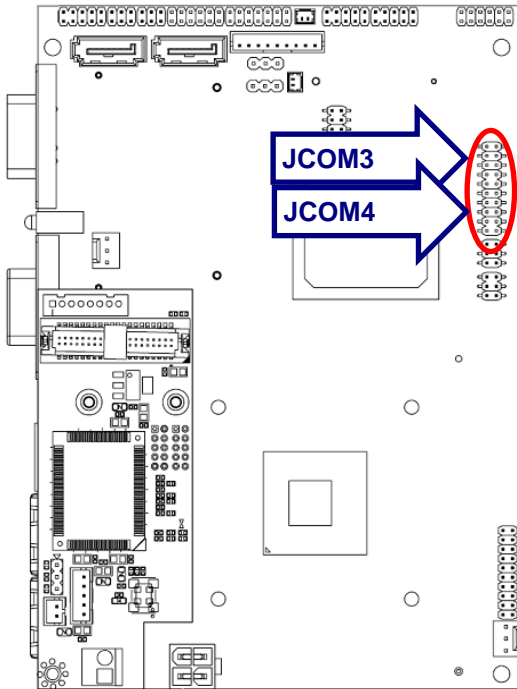

Signal	PIN	PIN	Signal
DCD	1	2	RxD
TxD	3	4	DTR
GND	5	6	DSR
RTS	7	8	CTS
RI	9	10	NC

# ECM-PNV

## 3.4.13 General purpose I/O connector (JDIO)

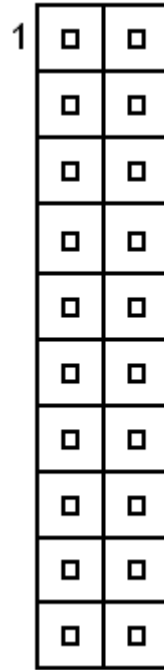
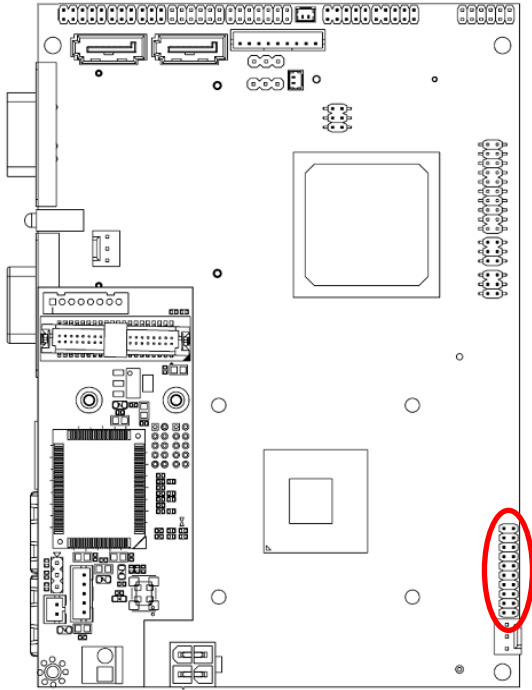

Signal	PIN	PIN	Signal
DIO0	1	2	DIO10
DIO1	3	4	DIO11
DIO2	5	6	DIO12
DIO3	7	8	DIO13
DIO4	9	10	DIO14
DIO5	11	12	DIO15
DIO6	13	14	DIO16
DIO7	15	16	DIO17
SMB_CLK	17	18	SMB_DATA
GND	19	20	+5V

### 3.4.14 Touch panel connector (JTOUCH)

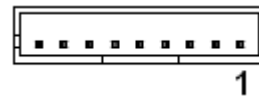
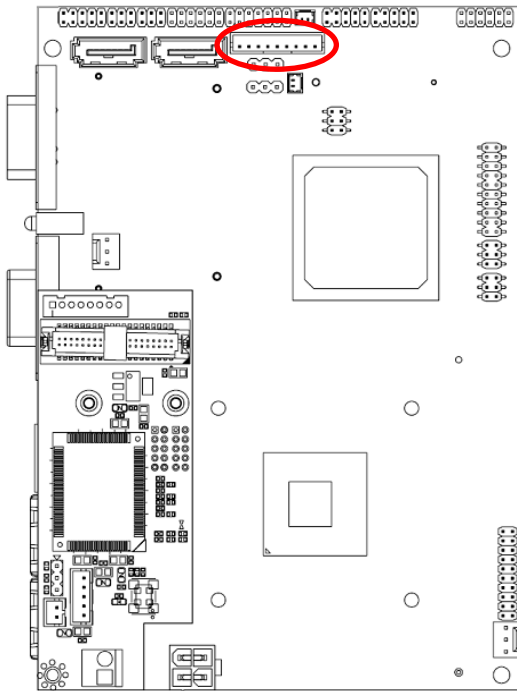

PIN	4-WIRE	5-WIRE	8-WIRE
1	N/A	N/A	Right Sense
2	N/A	N/A	Left Sense
3	N/A	N/A	Bottom Sense
4	N/A	Sense	Top Sense
5	Right	LR	Right Excite
6	Left	LL	Left Excite
7	Bottom	UR	Bottom Excite
8	Top	UL	Top Excite
9	GND	GND	GND

### 3.4.15 USB connector 2 & 3/ 6 & 7 (JUSB2/ JUSB3)

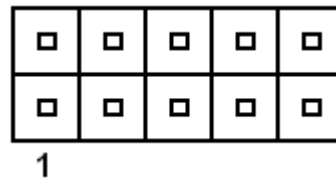
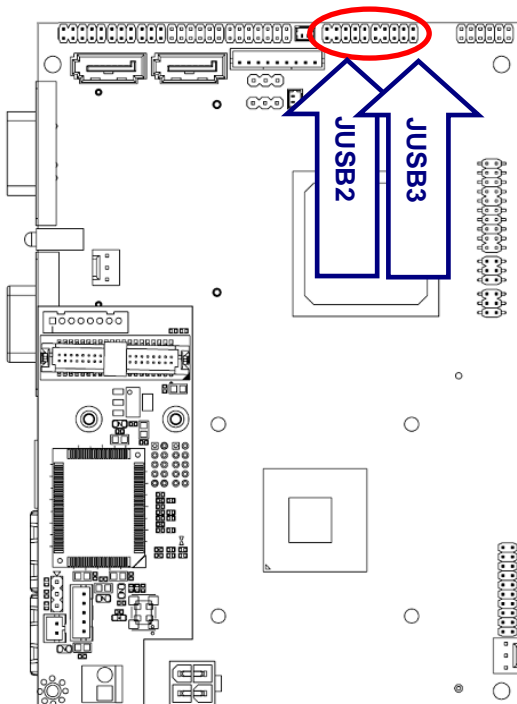

Signal	PIN	PIN	Signal
+5V	1	2	GND
N3/ N7	3	4	GND
P3/ P7	5	6	P2/ P6
GND	7	8	N2/ N6
GND	9	10	+5V

# ECM-PNV

## 3.4.16 LVDS connector (HJLVDS1)

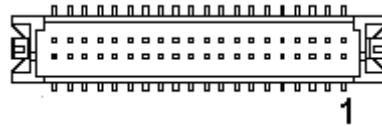
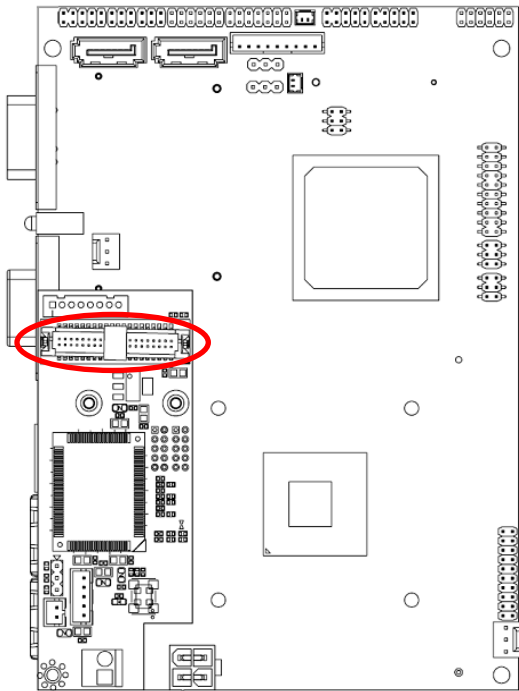

Signal	PIN	PIN	Signal
+5V	2	1	+3.3V
+5V	4	3	+3.3V
SPDATA	6	5	SPCLK
GND	8	7	GND
YA0P	10	9	YA1P
YA0M	12	11	YA1M
GND	14	13	GND
YA2P	16	15	YA3P
YA2M	18	17	YA3M
GND	20	19	GND
YA4P	22	21	YA5P
YA4M	24	23	YA5M
GND	26	25	GND
YA6P	28	27	YA7P
YA6M	30	29	YA7M
GND	32	31	GND
CLK1P	34	33	CLK2P
CLK1M	36	35	CLK2M
GND	38	37	GND
+12V	40	39	+12V

### 3.4.17 LCD Inverter Connector (HJBKL1/ HJBKL2)

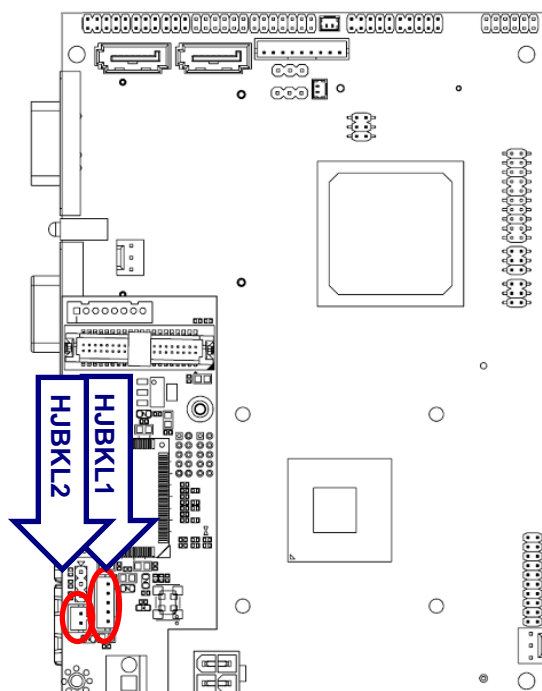

HJBKL1



HJBKL2

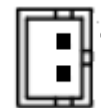

Signal	PIN
+12V	1
GND	2
BLK_ON	3
BRIGHT	4
+5V	5

Signal	PIN
+12V	1
GND	2



**Note:**

For inverters with adjustable Backlight function, it is possible to control the LCD brightness through the VR signal controlled by HJVR. Please see the HJVR section for detailed circuitry information.

#### 3.4.17.1 Signal Description – LCD Inverter Connector (HJBKL1)

Signal	Signal Description
BRIGHT	$V_{adj} = 0.75V \sim 4.25V$ (Recommended: $4.7K\Omega$ , $>1/16W$ )
BKL_ON	LCD backlight ON/OFF control signal

# ECM-PNV

## 3.4.18 LCD backlight brightness adjustment (HJVR)

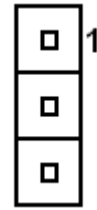
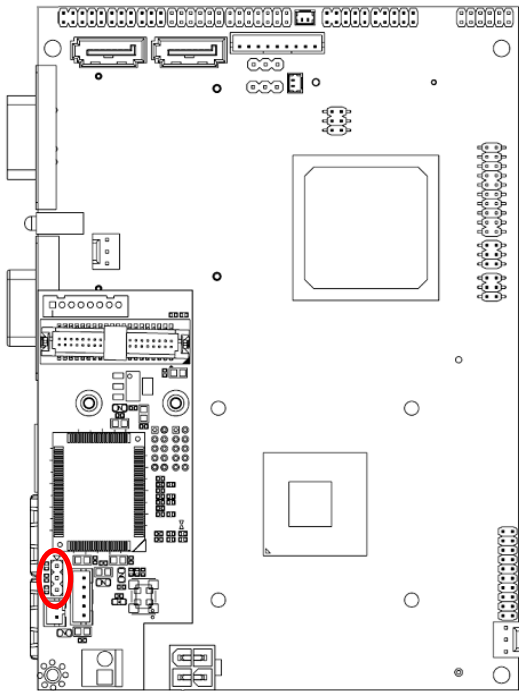

Signal	PIN
+5V	1
BRIGHT	2
GND	3

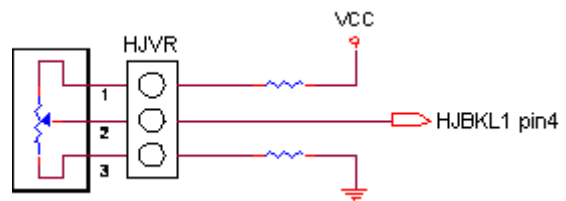

Variation Resistor

(Recommended: 4.7KΩ, >1/16W)

## 3.4.19 Power connector (PWR)

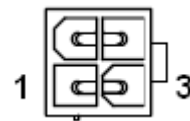
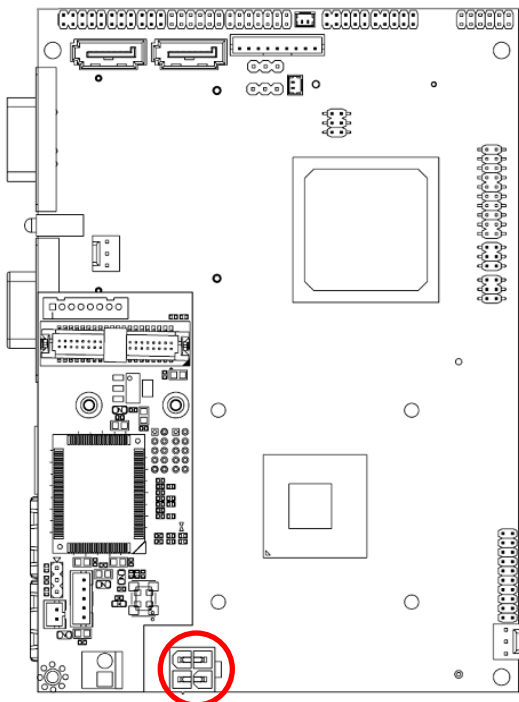

Signal	PIN	PIN	Signal
GND	2	4	VIN
GND	1	3	VIN



### 3.4.20 SATA power connector (S\_PWR1)

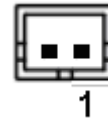
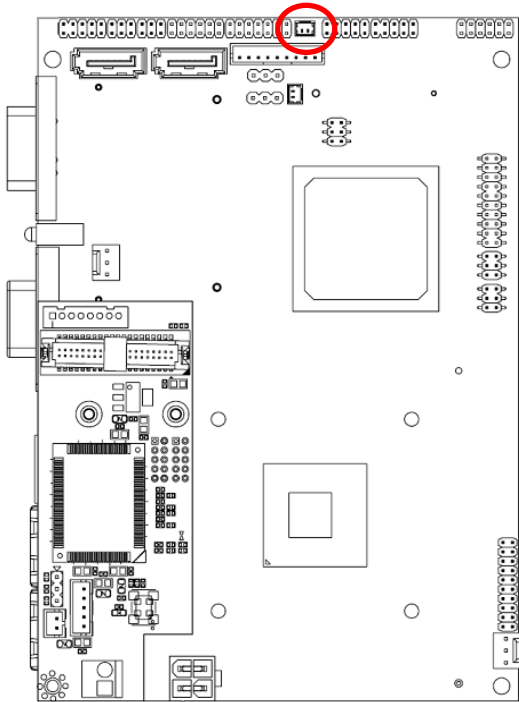

Signal	PIN
SATA_PWR	2
GND	1



**Note:**

SATA\_PWR is +5V for SATA DOM uses.

## 3.5 Audio / USB Daughter Board User's Guide

### 3.5.1 Jumper and Connector Layout

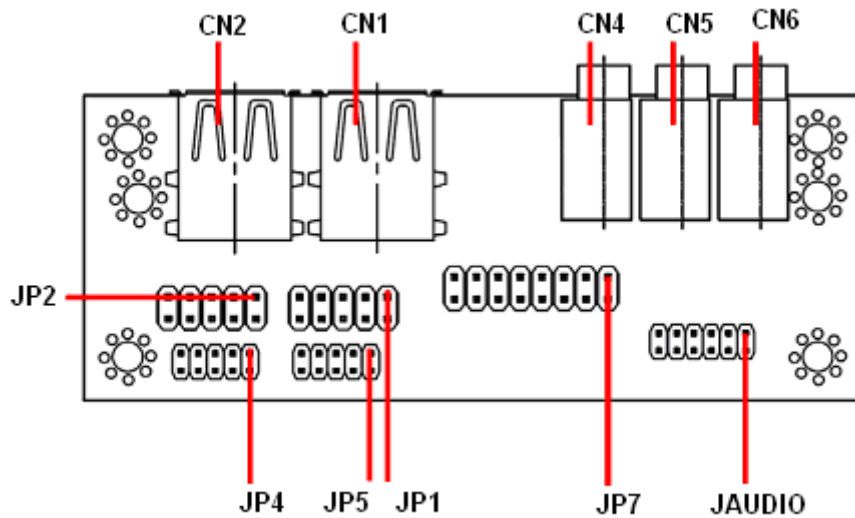

### 3.5.2 Jumper and Connector List

#### Connectors

Label	Function	Note
<b>CN1, CN2</b>	USB connector	
<b>CN4</b>	Line out connector	Phone Jack
<b>CN5</b>	Line in connector	Phone Jack
<b>CN6</b>	Mic in connector	Phone Jack
<b>JAUDIO</b>	Audio connector	6 x 2 header, pitch 2.0mm
<b>JP1</b>	2.54mm USB connector	5 x 2 header, pitch 2.54mm
<b>JP2</b>	2.54mm USB connector	5 x 2 header, pitch 2.54mm
<b>JP4</b>	2.0mm USB connector	5 x 2 header, pitch 2.0mm
<b>JP5</b>	2.0mm USB connector	5 x 2 header, pitch 2.0mm
<b>JP7</b>	TV / Audio connector	8 x 2 header, pitch 2.54mm

## 3.5.3 Setting Jumper and Connector

## Audio Connector (JAUDIO)

Signal	PIN	PIN	Signal
OUTR	1	2	OUTL
GND	3	4	GND
INR1	5	6	INL1
MICIN1	7	8	AREF
FRONT-JD1	9	10	LINE1-JD1
MIC1-JD1	11	12	GND

## 2.54mm USB Connector (JP1)

Signal	PIN	PIN	Signal
+5V	1	2	GND
D1-	3	4	GND
D1+	5	6	D2+
GND	7	8	D2-
GND	9	10	+5V



**Note:** Wrong USB cable configuration with your USB devices might cause your USB devices damaged.

## 2.54mm USB Connector (JP2)

Signal	PIN	PIN	Signal
+5V	1	2	GND
D3-	3	4	GND
D3+	5	6	D4+
GND	7	8	D4-
GND	9	10	+5V

## TV / Audio Connector (JP7)

Signal	PIN	PIN	Signal
Mic In	1	2	Mic Bais
GND	3	4	GND
Line out L	5	6	Line out R
SPK L	7	8	SPK R
Line in L	9	10	Line in R
GND	11	12	NC
TVGND	13	14	NC
TVGND	15	16	COMP

## 2.0mm USB Connector (JP4)

Signal	PIN	PIN	Signal
+5V	1	2	GND
D3-	3	4	GND
D3+	5	6	D4+
GND	7	8	D4-
GND	9	10	+5V

## 2.0mm USB Connector (JP5)

Signal	PIN	PIN	Signal
+5V	1	2	GND
D1-	3	4	GND
D1+	5	6	D2+
GND	7	8	D2-
GND	9	10	+5V

# 4. BIOS Setup



## 4.1 Introduction

The BIOS setup program allows users to modify the basic system configuration. In this following chapter will describe how to access the BIOS setup program and the configuration options that may be changed.

## 4.2 Starting Setup

The AMI BIOS™ is immediately activated when you first power on the computer. The BIOS reads the system information contained in the CMOS and begins the process of checking out the system and configuring it. When it finishes, the BIOS will seek an operating system on one of the disks and then launch and turn control over to the operating system.

While the BIOS is in control, the Setup program can be activated in one of two ways:

By pressing <Del> immediately after switching the system on, or

By pressing the <Del> key when the following message appears briefly at the bottom of the screen during the POST (Power On Self Test).

**Press DEL to enter SETUP**

If the message disappears before you respond and you still wish to enter Setup, restart the system to try again by turning it OFF then ON or pressing the "RESET" button on the system case. You may also restart by simultaneously pressing <Ctrl>, <Alt>, and <Delete> keys. If you do not press the keys at the correct time and the system does not boot, an error message will be displayed and you will again be asked to.

**Press F1 to Continue, DEL to enter SETUP**

### 4.3 Using Setup

In general, you use the arrow keys to highlight items, press <Enter> to select, use the PageUp and PageDown keys to change entries, press <F1> for help and press <Esc> to quit. The following table provides more detail about how to navigate in the Setup program using the keyboard.

Button	Description
↑	Move to previous item
↓	Move to next item
←	Move to the item in the left hand
→	Move to the item in the right hand
Esc key	Main Menu -- Quit and not save changes into CMOS Status Page Setup Menu and Option Page Setup Menu -- Exit current page and return to Main Menu
PgUp key	Increase the numeric value or make changes
PgDn key	Decrease the numeric value or make changes
+ key	Increase the numeric value or make changes
- key	Decrease the numeric value or make changes
F1 key	General help, only for Status Page Setup Menu and Option Page Setup Menu
(Shift) F2 key	Change color from total 16 colors. F2 to select color forward, (Shift) F2 to select color backward
F3 key	Calendar, only for Status Page Setup Menu
F4 key	Reserved
F5 key	Restore the previous CMOS value from CMOS, only for Option Page Setup Menu
F6 key	Load the default CMOS value from BIOS default table, only for Option Page Setup Menu
F7 key	Load the default
F8 key	Reserved
F9 key	Reserved
F10 key	Save all the CMOS changes, only for Main Menu

- **Navigating Through The Menu Bar**

Use the left and right arrow keys to choose the menu you want to be in.



**Note:** Some of the navigation keys differ from one screen to another.

- **To Display a Sub Menu**

Use the arrow keys to move the cursor to the sub menu you want. Then press <Enter>. A “>” pointer marks all sub menus.

## 4.4 Getting Help

Press F1 to pop up a small help window that describes the appropriate keys to use and the possible selections for the highlighted item. To exit the Help Window press <Esc> or the F1 key again.

## 4.5 In Case of Problems

If, after making and saving system changes with Setup, you discover that your computer no longer is able to boot, the AMI BIOS supports an override to the CMOS settings which resets your system to its defaults.

The best advice is to only alter settings which you thoroughly understand. To this end, we strongly recommend that you avoid making any changes to the chipset defaults. These defaults have been carefully chosen by both Award and your systems manufacturer to provide the absolute maximum performance and reliability. Even a seemingly small change to the chipset setup has the potential for causing you to use the override.

## 4.6 BIOS setup

Once you enter the AMI BIOS CMOS Setup Utility, the Main Menu will appear on the screen. The Main Menu allows you to select from several setup functions and exit choices. Use the arrow keys to select among the items and press <Enter> to accept and enter the sub-menu.

### 4.6.1 Main Menu

This section allows you to record some basic hardware configurations in your computer and set the system clock.

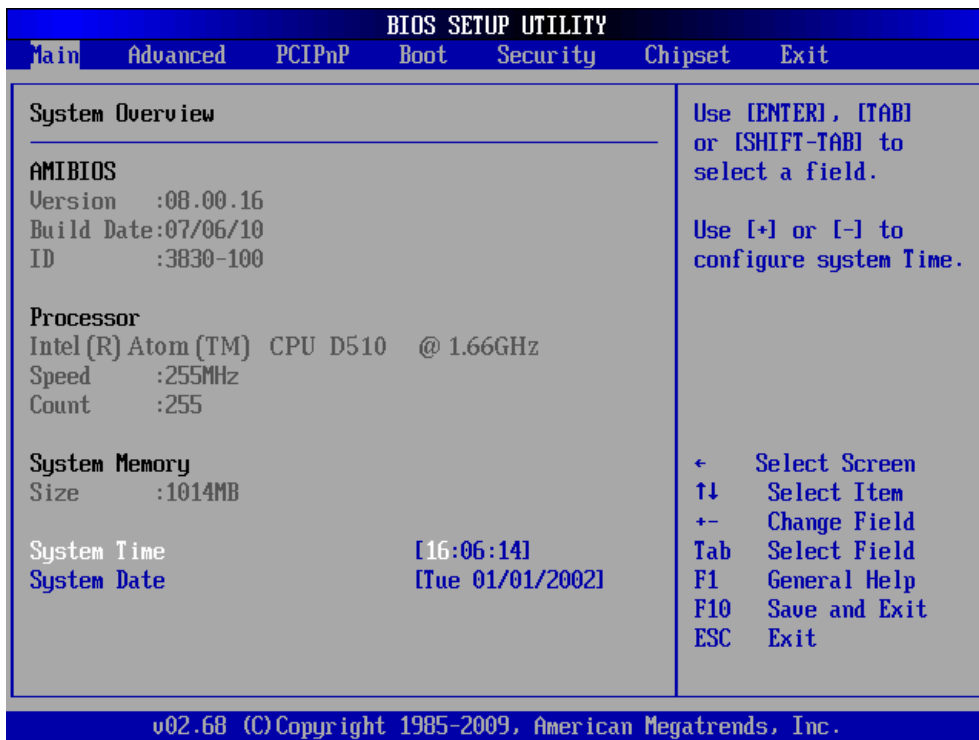

#### 4.6.1.1 System Date

Use the system time option to set the system time. Manually enter the hours, minutes and seconds.

#### 4.6.1.2 System Time

Use the system Date option to set the system date. Manually enter the day, month and year.



**Note:** The BIOS setup screens shown in this chapter are for reference purposes only, and may not exactly match what you see on your screen.

Visit the Avalue website ([www.avalue.com.tw](http://www.avalue.com.tw)) to download the latest product and BIOS information.



## 4.6.2 Advanced Menu

This section allows you to configure your CPU and other system devices for basic operation through the following sub-menus.

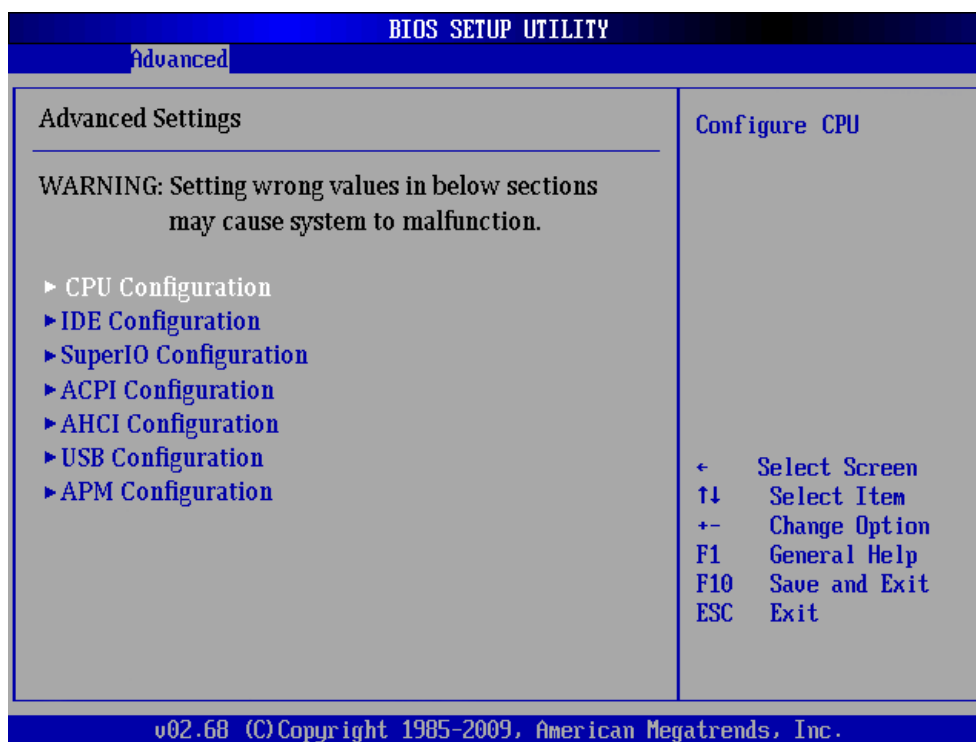

## ECM-PNV

### 4.6.2.1 CPU Configuration

Use the CPU configuration menu to view detailed CPU specification and configure the CPU.

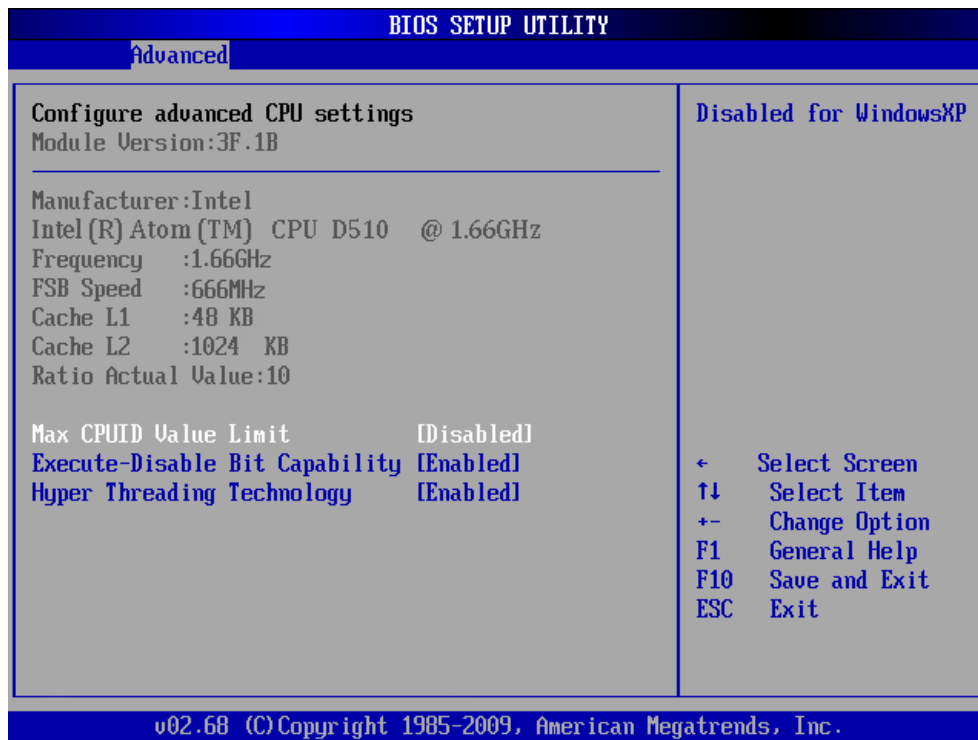

Item	Options	Description
<b>Max CPUID Value Limit</b>	Disabled, Enabled	This item allows you to limit CPUID maximum value.
<b>Execute-Disable Bit Capability</b>	Disabled, Enabled	This item allows you to enable or disable the No-Execution page protection technology.
<b>Hyper Threading Technology</b>	Disabled, Enabled	This item allows you to enable or disable Intel® Hyper Threading technology.

4.6.2.2 IDE Configuration

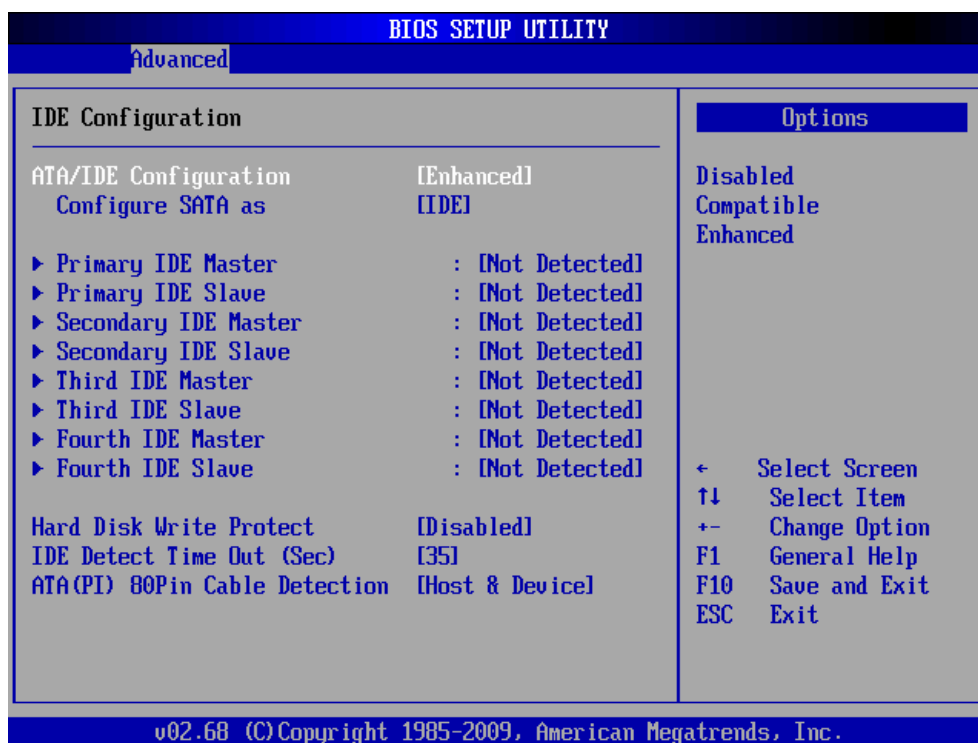

Item	Options	Description
<b>ATA/ IDE Configuration</b>	Disabled, Compatible, Enhanced	This can be configured as Disabled, Compatible or Enhanced.
<b>Configure SATA as</b>	IDE, RAID, AHCI	Use the configure SATA as BIOS option to configure the SATA port as an IDE drive, a SATA drive (AHCI mode) or a SATA drive in a RAID configuration.
<b>Primary/ Secondary/ Third/ Fourth IDE Master</b>	Disabled, Enabled	Use the IDE Master and IDE Slave configuration menu to view both primary and secondary IDE device details and configure the IDE devices connected to the system.
<b>Primary/ Secondary/ Third/ Fourth IDE Slave</b>	Disabled, Enabled	Use the IDE Master and IDE Slave configuration menu to view both primary and secondary IDE device details and configure the IDE devices connected to the system.
<b>Hard Disk Write Protect</b>	Disabled, Enabled	Disable/ Enable device write protection. This will effective only if device is accessed through BIOS.
<b>IDE Detect Time Out (Sec)</b>	0/ 5/ 10/ 15/ 20/ 25/ 30/ 35	This allows you to select the time out value for detecting ATA/ ATAPI devices.

## ECM-PNV

<b>ATA (PI) 80Pin Cable Detection</b>	Host & Device, Host, Device	This item allows you to select ATA cable detection mode.
---------------------------------------	-----------------------------------	--

### 4.6.2.3 Super IO Configuration

You can use this item to set up or change the Super IO configuration for FDD controllers, parallel ports and serial ports.

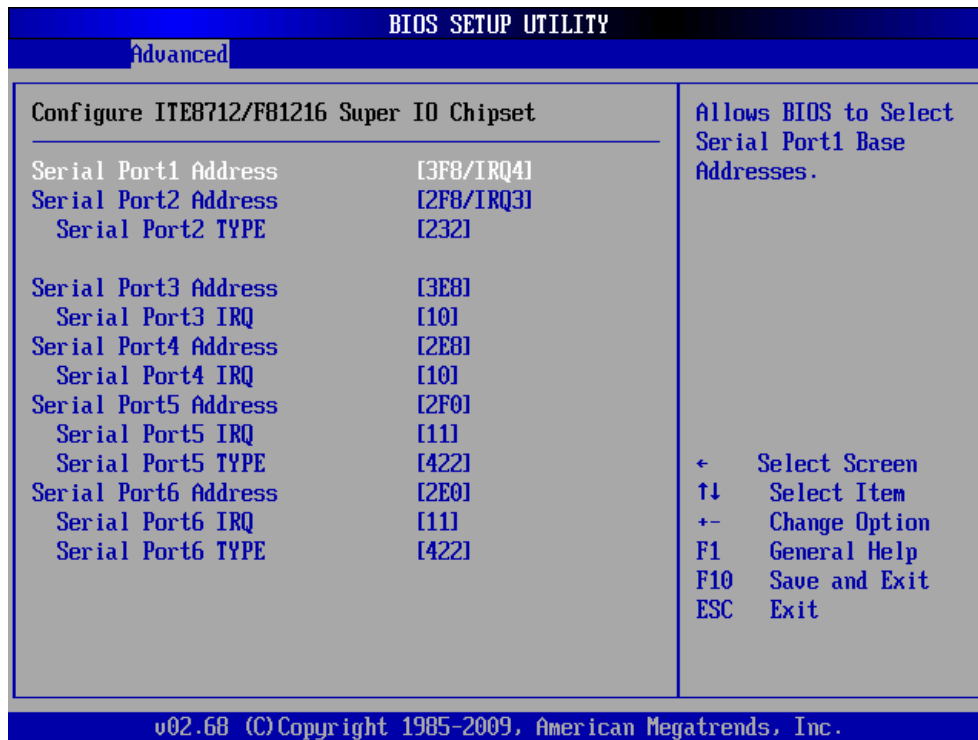

Item	Options	Description
<b>Serial Port 1/ 2/ 3/ 4/ 5/ 6 Address</b>	Disabled, 3F8, 2F8, 3E8, 2E8, 2F0, 2E0	This item allows you select serial port 1 ~ 6 of base addresses.
<b>Serial Port 2/ 5/ 6 Type</b>	422, 485	This item allows you select serial port 2/ 5/ 6 of type.
<b>Serial Port 3/ 4/ 5/ 6 IRQ</b>	4/ 9/ 10/ 11	This item allows you select serial port 3 ~ 6 of IRQ.

#### 4.6.2.4 Hardware Health Configuration

This section allows you to control H/W monitoring.

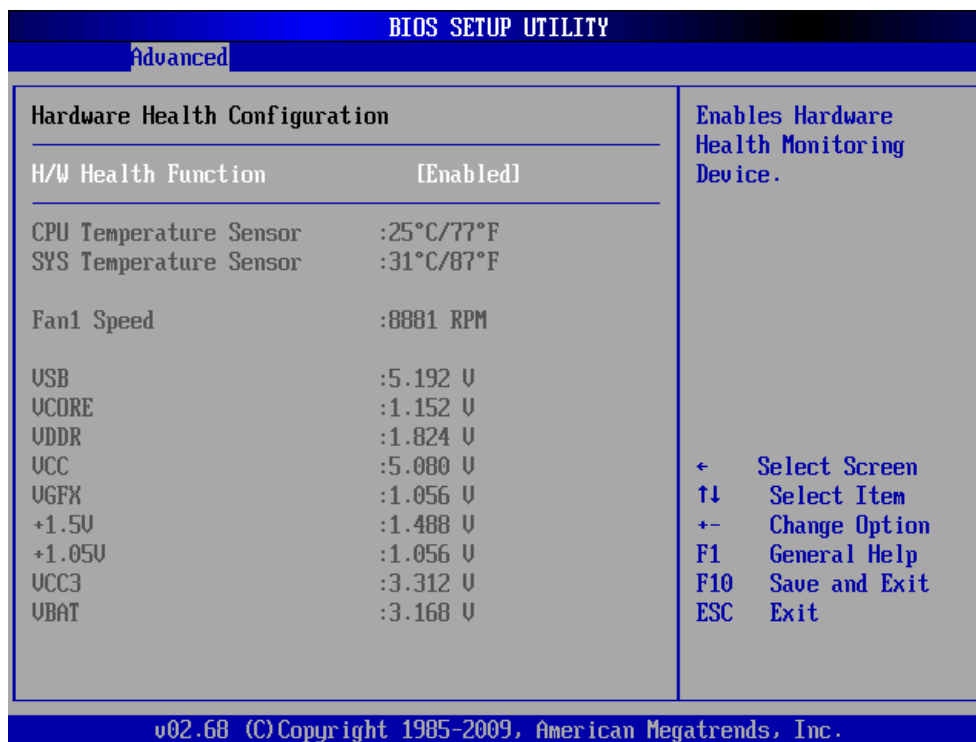

#### 4.6.2.5 ACPI Settings

You can use this item to set up ACPI Configuration. Please refer to 4.5.2.5.1 ~ 4.5.2.5.3 for more details.

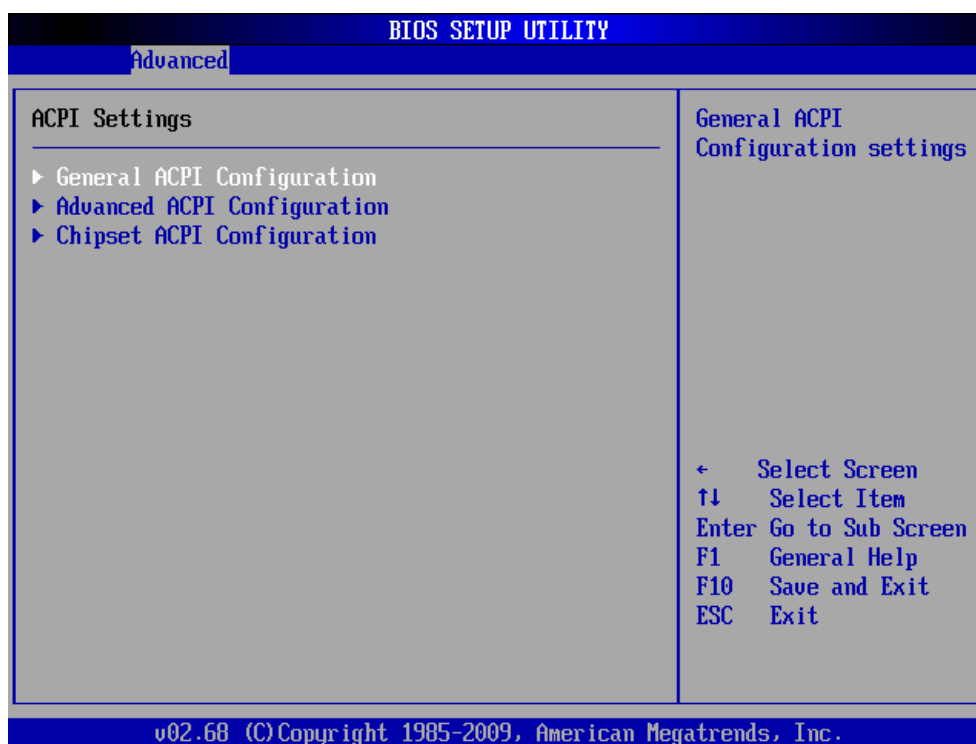

# ECM-PNV

## 4.6.2.5.1 General ACPI Configuration

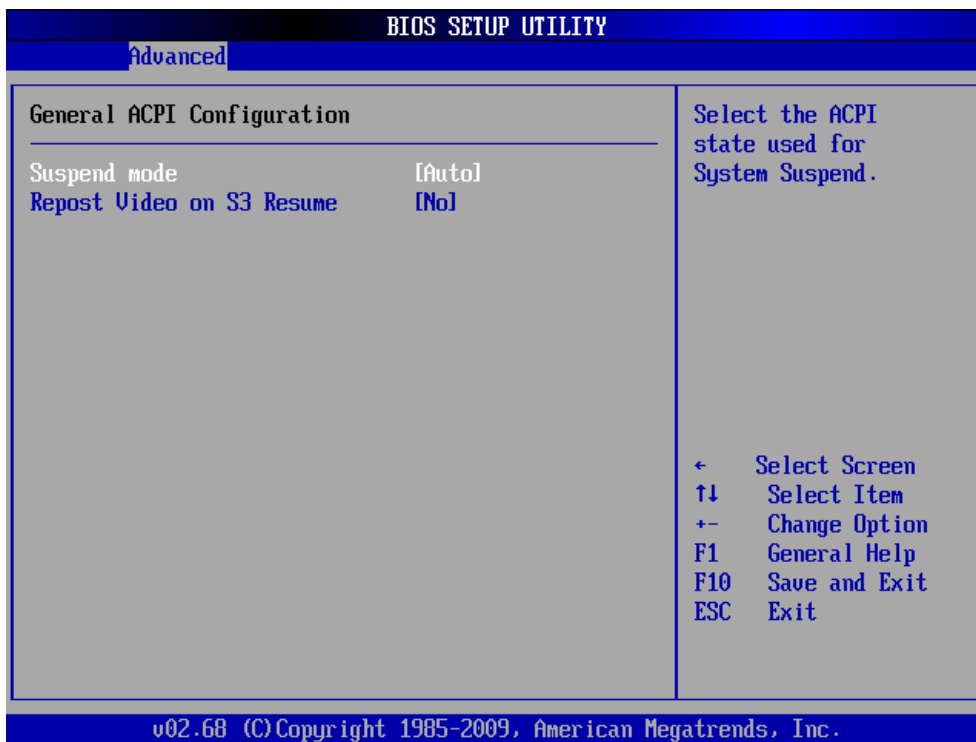

Item	Options	Description
<b>Suspend Mode</b>	S1 (POS), S3 (STR), Auto	Select the ACPI states used for system suspend.
<b>Repost Video on S3 Resume</b>	No, Yes	This item allows you to invoke VA BIOS POST on S3/ STR resume.

### 4.6.2.5.2 Advanced ACPI Configuration

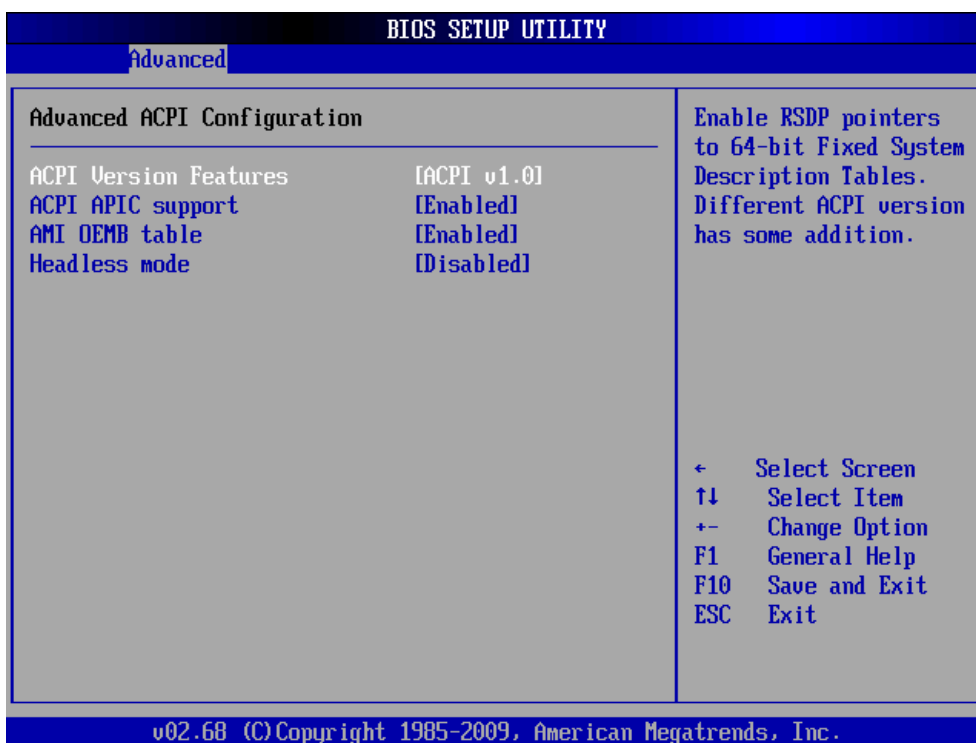

Item	Options	Description
<b>ACPI Version Features</b>	ACPI v1.0, ACPI v2.0, ACPI v3.0	This item allows you enable RSDP pointers to 64-bit fixed system description tables.
<b>ACPI APIC support</b>	Enabled, Disabled	Include APIC table pointer to RSDT pointer list.
<b>AMI OEMB table</b>	Enabled, Disabled	Include OEMB table pointer to R(x)SDT pointer list.
<b>Headless mode</b>	Disabled, Enabled	Enable/ Disable Headless operation mode through ACPI.

## ECM-PNV

### 4.6.2.5.3 Chipset ACPI Configuration

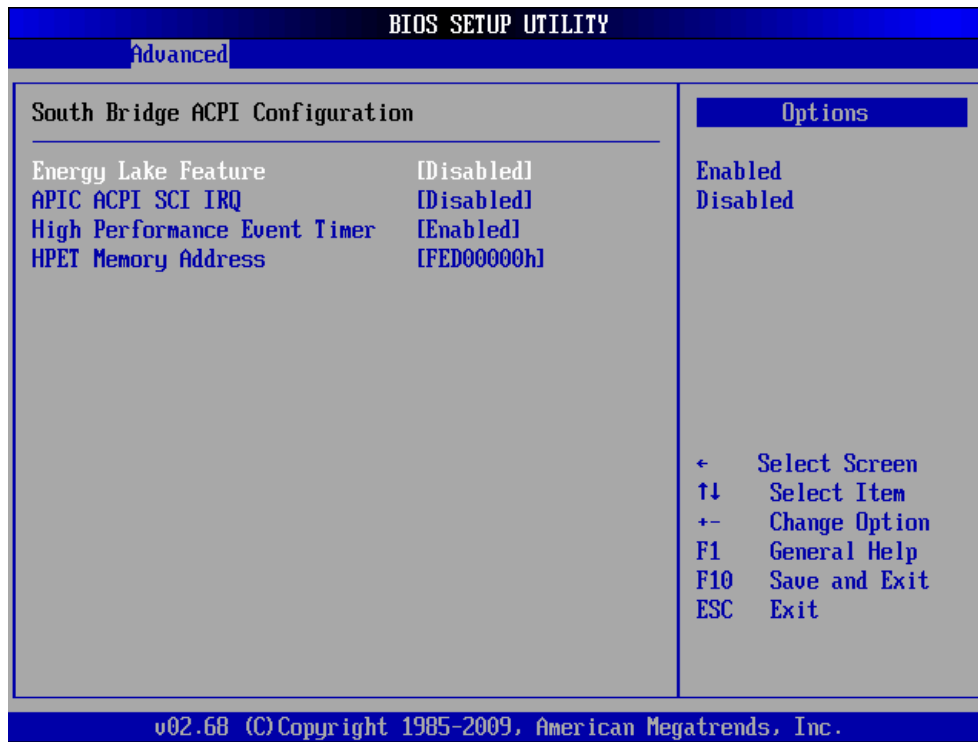

Item	Options	Description
<b>Energy Lake Feature</b>	Disabled, Enabled	This item allows selecting energy lake feature mode.
<b>APIC ACPI SCI IRQ</b>	Disabled, Enabled	This item allows to enable/ disable APIC ACPI SCI IRQ.
<b>High Performance Event Timer</b>	Disabled, Enabled	This section helps to set high performance event timer.
<b>HPET Memory Address</b>	FES00000h, FES01000h, FES02000h	This item allows selecting HPET memory address.



#### 4.6.2.6 AHCI Configuration

While entering setup, BIOS auto detects the presence of IDE devices. This displays the status of auto detection of IDE devices.

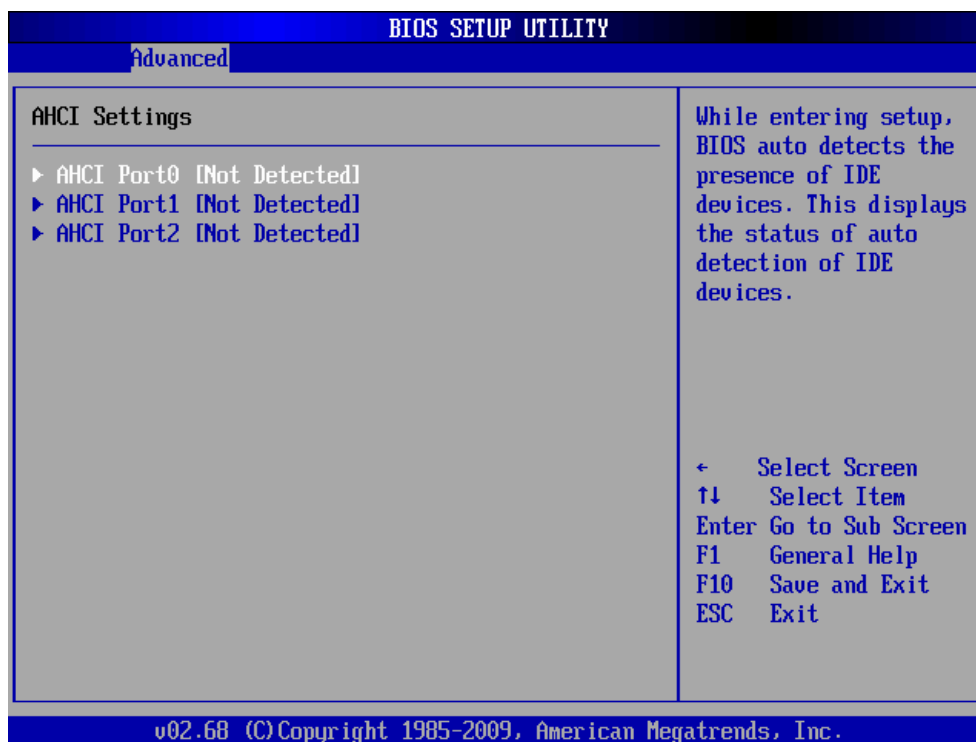

# ECM-PNV

## 4.6.2.6.1 AHCI Port0

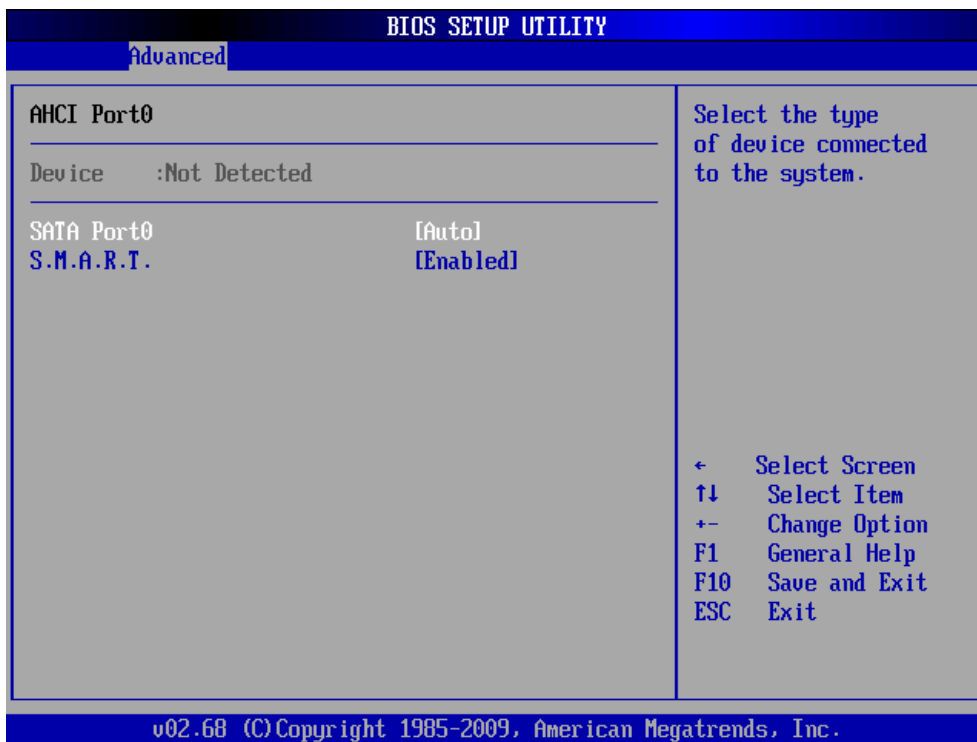

Item	Options	Description
SATA Port0	Auto, Not Installed	Serial port 0 mode select.
S.M.A.R.T.	Disabled, Enabled	Select the smart monitoring, analysis, and reporting technology.

4.6.2.6.2 AHCI Port1

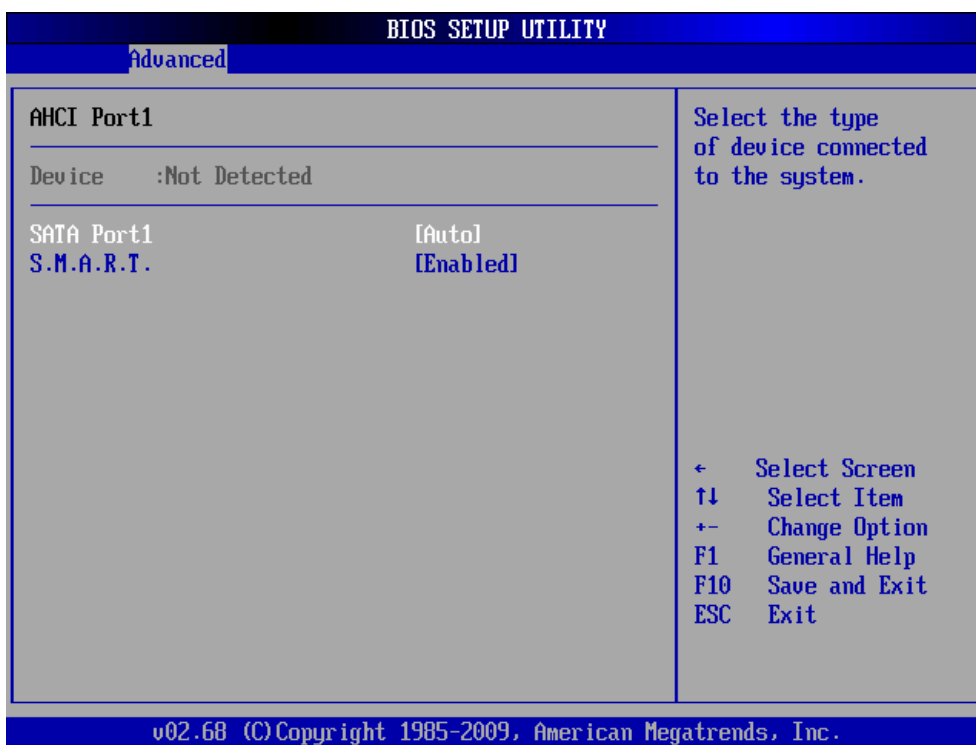

Item	Options	Description
SATA Port1	Auto, Not Installed	Serial port 1 mode select.
S.M.A.R.T.	Disabled, Enabled	Select the smart monitoring, analysis, and reporting technology.

ECM-PNV

4.6.2.6.3 AHCI Port2

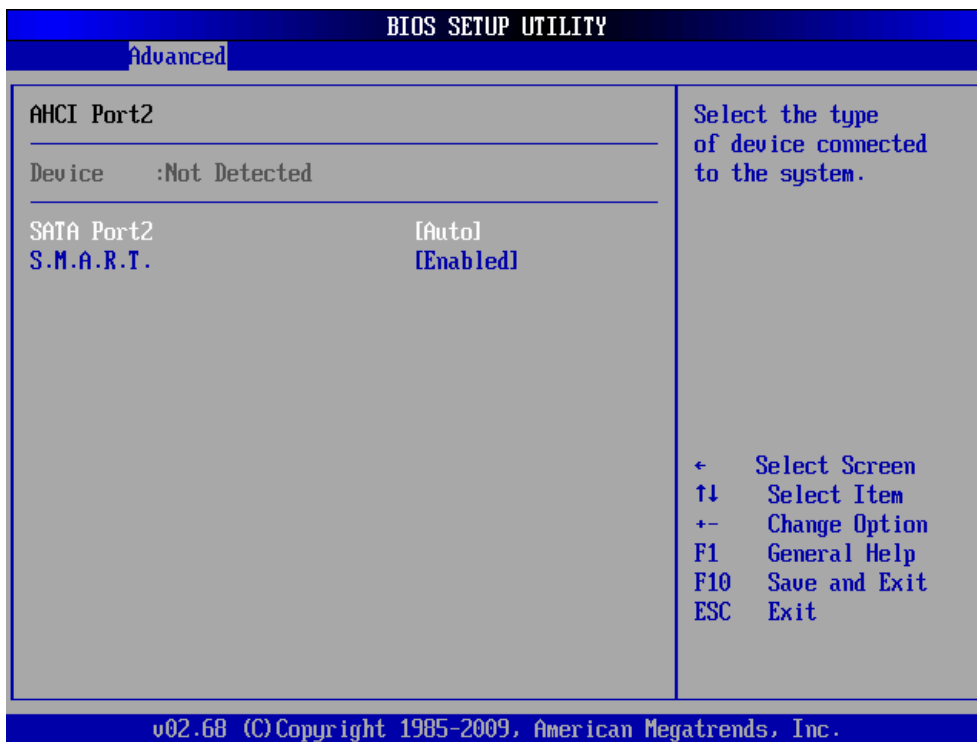

Item	Options	Description
SATA Port2	Auto, Not Installed	Serial port 2 mode select.
S.M.A.R.T.	Disabled, Enabled	Select the smart monitoring, analysis, and reporting technology.

### 4.6.2.7 USB Configuration

The USB configuration menu is used to read USB configuration information and configure the USB setting.



Item	Options	Description
<b>Legacy USB Support</b>	Enabled, Disabled, Auto	Use the Legacy USB Support BIOS option to enable USB mouse and USB keyboard support. Normally if this option is not enabled, any attached USB mouse or USB keyboard does not become available until a USB compatible operating system is fully booted with all USB drivers loaded. When this option is enabled, any attached USB mouse or USB keyboard can control the system even when there is no USB driver loaded onto the system.
<b>USB 2.0 Controller Mode</b>	HiSpeed (480Mbps), FullSpeed (12Mbps)	This item allows you to select HiSpeed (480Mbps) or FullSpeed (12Mbps).
<b>BIOS EHCI Hand-Off</b>	Enabled, Disabled	This is a workaround for OSs without EHCI hand-off support. The EHCI ownership change should be claimed by EHCI driver.
<b>Hotplug USB FDD Support</b>	Enabled, Disabled, Auto	A dummy FDD devices is created that will be associated with the hotplugged FDD later. Auto option creates this dummy device only if there is no USB present.

4.6.2.7.1 USB Mass Storage Device Configuration

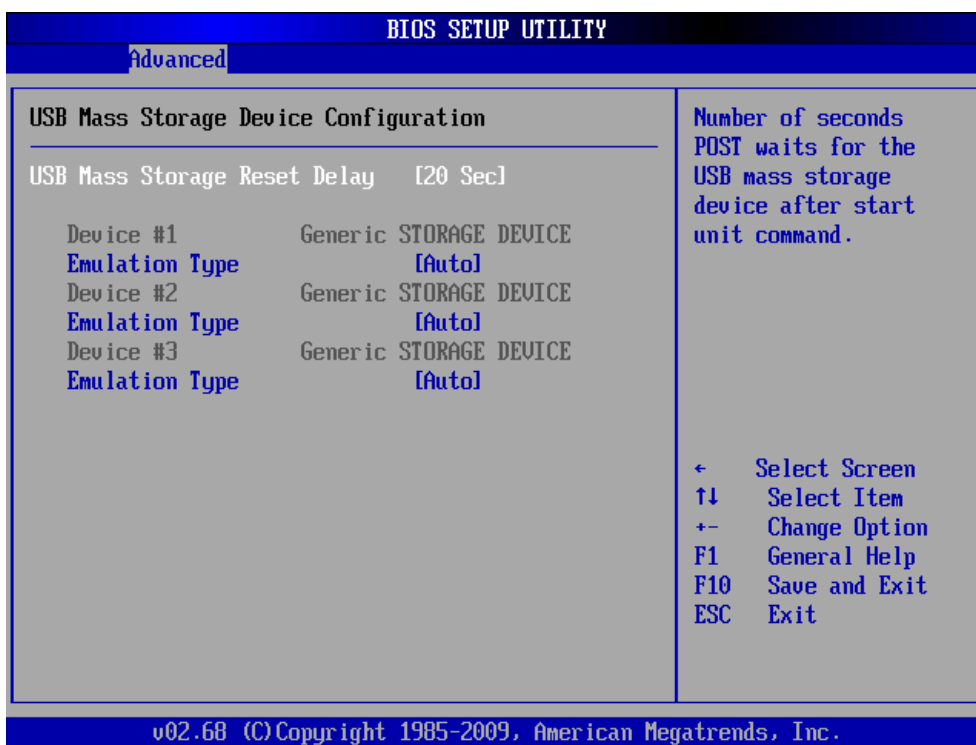

Item	Options	Description
<b>USB Mass Storage Reset Delay</b>	10, 20, 30, 40 sec.	Number of sends POST wait for the USB mass device after start unit command.
<b>Device #1/ #2/ #3 Emulation Type</b>	Auto, Floppy, Forced FDD, Hard-Disk, CD-ROM.	This item allows you to set up mass storage devices.

### 4.6.2.8 APM Configuration

The APM Configuration menu allows the advanced power management options to be configured.

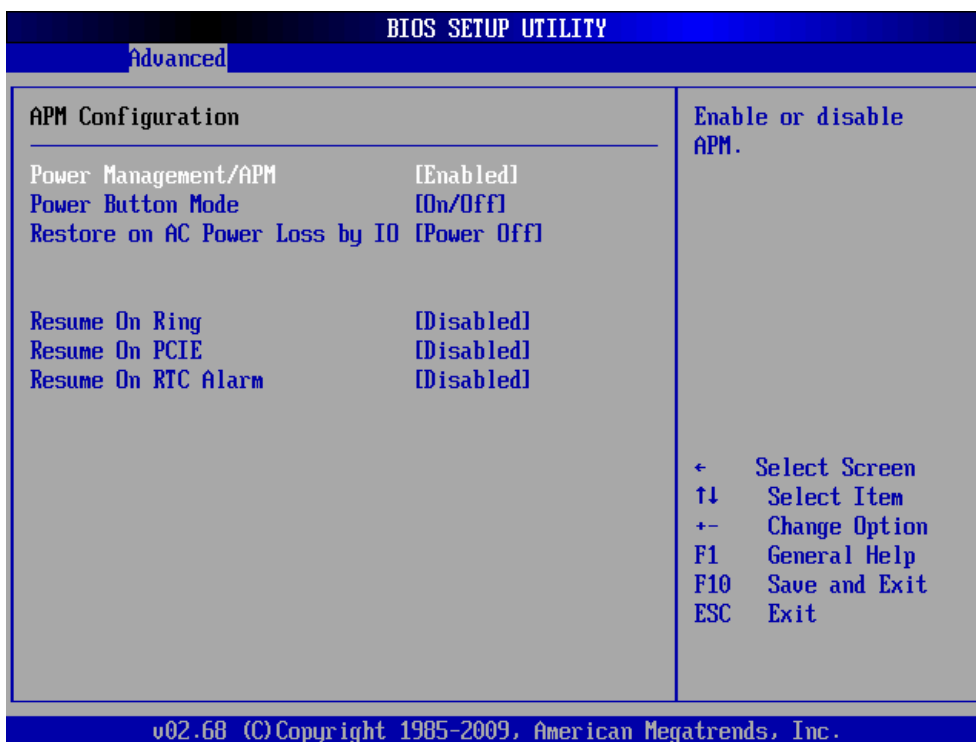

Item	Options	Description
<b>Power Management/ APM</b>	Enabled, Disabled	This item helps to select power management mode.
<b>Power Button Mode</b>	On/ Off, Suspend	This section allows you to select power button mode.
<b>Restore on AC Power Loss by IO</b>	Power On, Power Off, Last State	Use this to set up the system response after a power failure.
<b>Resume On Ring</b>	Disabled, Enabled	Use the Resume on Ring BIOS option to enable activity on the RI (ring in) modem line to rouse the system from a suspend or standby state. That is, the system is roused by an incoming call on modem.
<b>Resume On PCIE</b>	Disabled, Enabled	Use the Resume on PCIE BIOS option to enable activity on the PCIE signal to rouse the system from a suspend or standby state.
<b>Resume On RTC Alarm</b>	Disabled, Enabled	Use the Resume on RTC Alarm option to specify the time the system should be roused from a suspend state.

## ECM-PNV

### 4.6.3 PCI/ PnP

Use the PCI/ PnP menu to configure advanced PCI and PnP settings.

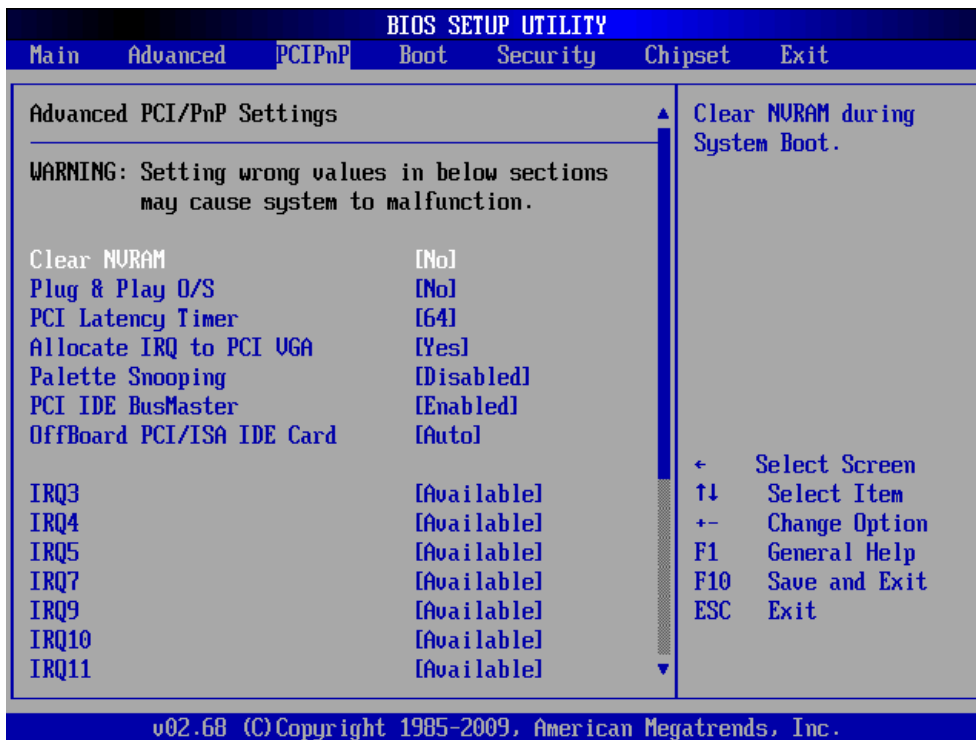

Item	Options	Description
<b>Clear NURAM</b>	No, Yes	Set this value to force the BIOS to clear the Non-volatile Random Access Memory (NVRAM). The Original and Fail-Safe default setting is No.
<b>Plug &amp; Play O/S</b>	No, Yes	When set No, BIOS configures all the device in the system. When set to Yes and if you still a Plug and Play operating system, the operating system configures the plug and Play device not required for boot.
<b>PCI Latency Timer</b>	32, 64, 96, 128, 160, 192, 224, 248	Value in units of PCI clocks for PCI device latency timer register.
<b>Allocate IRQ to PCI VGA</b>	No, Yes	When set to Yes will assigns IRQ to PCI VGA card if card requests IRQ. When set to No will not assign IRQ to PCI VGA card even if card requests an IRQ.
<b>PaletteSnooping</b>	Disabled, Enabled	This item designed to solve problems caused by some non-standard VGA card.



<b>PCI IDE BusMaster</b>	Disabled, Enabled	When set to enabled BIOS uses PCI busmastering for reading/ writing to IDE drives.
<b>OffBoard PCI/ ISA IDE Card</b>	Auto, PCI Slot 1/ 2/ 3/ 4/ 5/ 6	Some PCI IDE cards may require this to be set to the PCI slot number that is holding the card. When set to auto will works for most PCI IDE cards.
<b>IRQ3/ 4/ 5/ 7/ 9/ 10/ 11</b>	Available, Reserved	Use the IRQ# address to specify what IRQs can be assigned to a particular peripheral device.

#### 4.6.4 Boot

Use the Boot menu to configure system boot options.

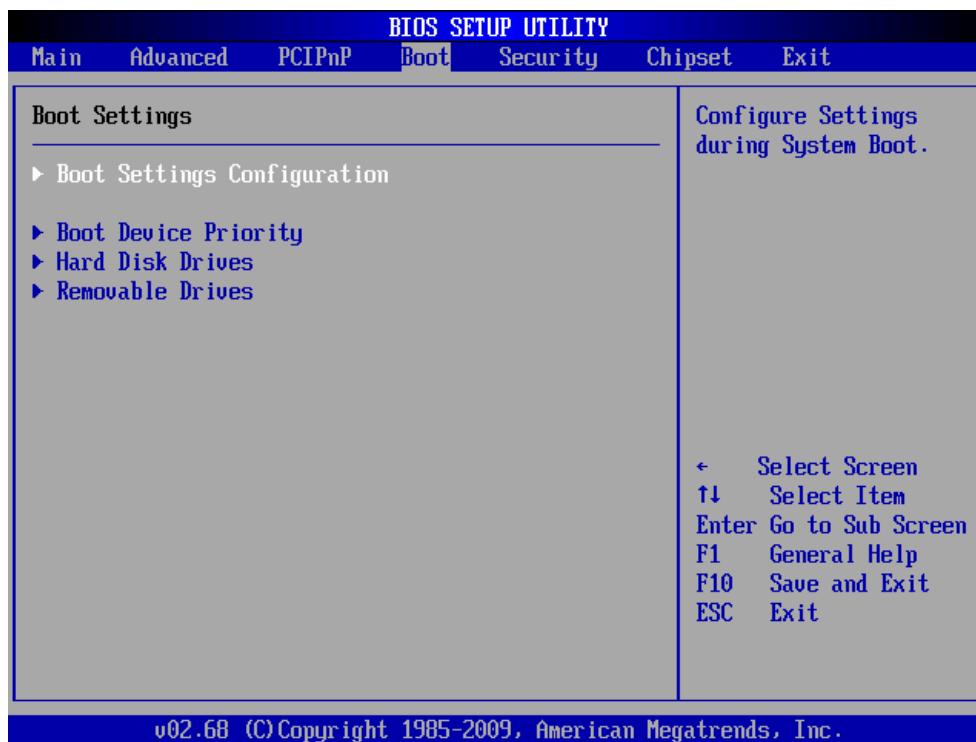

4.6.4.1 Boot settings Configuration

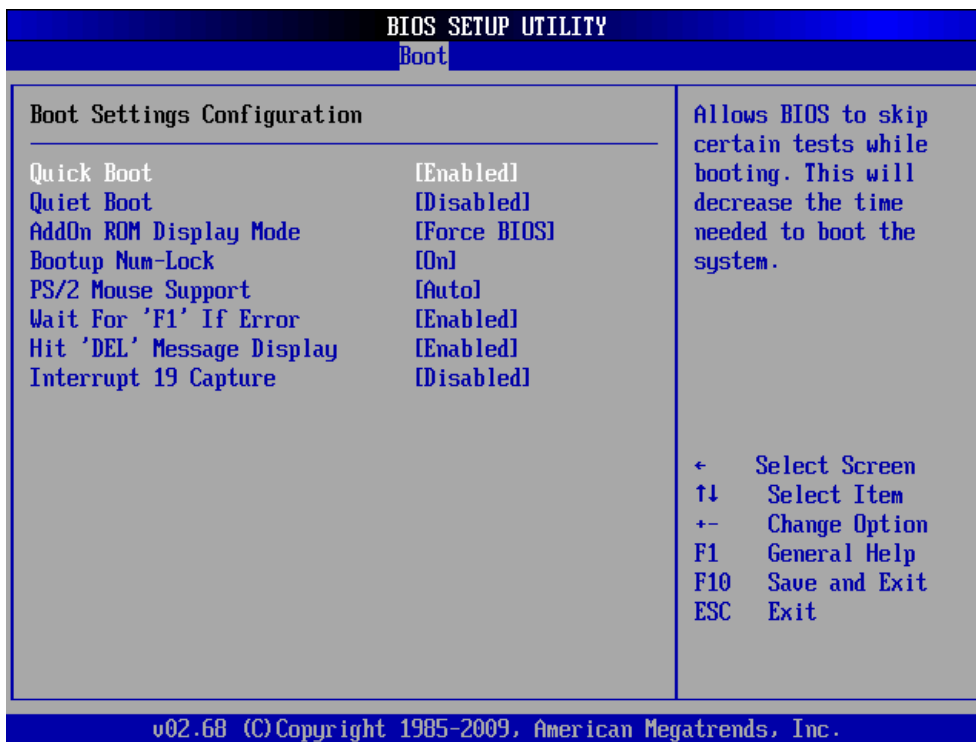

Item	Options	Description
<b>Quick Boot</b>	Disabled, Enabled	Use the quick boot BIOS option to make the computer speed up the boot process.
<b>Quiet Boot</b>	Disabled, Enabled	Use the quiet boot BIOS option to select the screen display when the system boots.
<b>AddOn ROM Display Mode</b>	Force BIOS, Keep Curren	The AddOn ROM Display Mode option allows add-on ROM (read-only memory) messages to be displayed.
<b>Bootup Num-Lock</b>	On, Off	The Bootup Num-Lock BIOS option allows the number Lock setting to be modified during boot up.
<b>PS/2 Mouse Support</b>	Disabled, Enabled, Auto	This select support for PS/w mouse.
<b>Wait For 'F1' if Error</b>	Disabled, Enabled	When set to enable, the system waits for the F1 key to be pressed when error occurs. This allows option ROM to trap interrupt19.
<b>Hit 'DEL' Message Display</b>	Disabled, Enabled	This displays 'Press <DEL> to run Setup> in POST.
<b>Interrupt 19 Capture</b>	Disabled, Enabled	This allows option ROMs to trap interrupt19.

#### 4.6.4.2 Boot device priority

Use the Boot Device Priority menu to specify the boot sequence from the available devices.

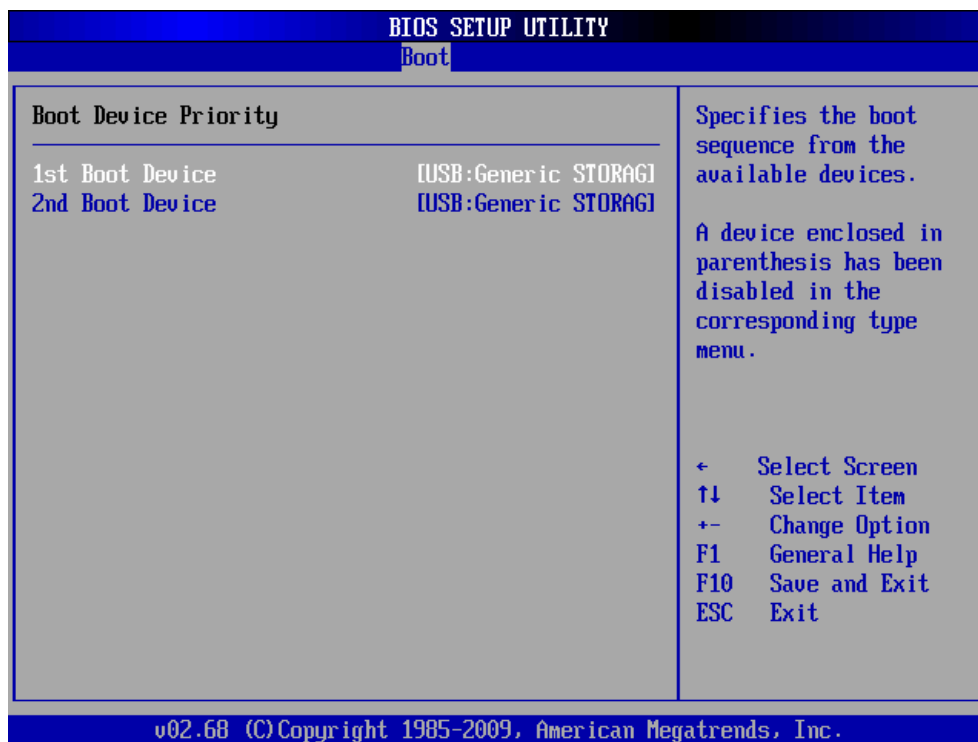

#### 4.6.4.3 Hard Disk Drives

Use the Hard Disk Drives menu to specify the boot sequence of the available HDDs.

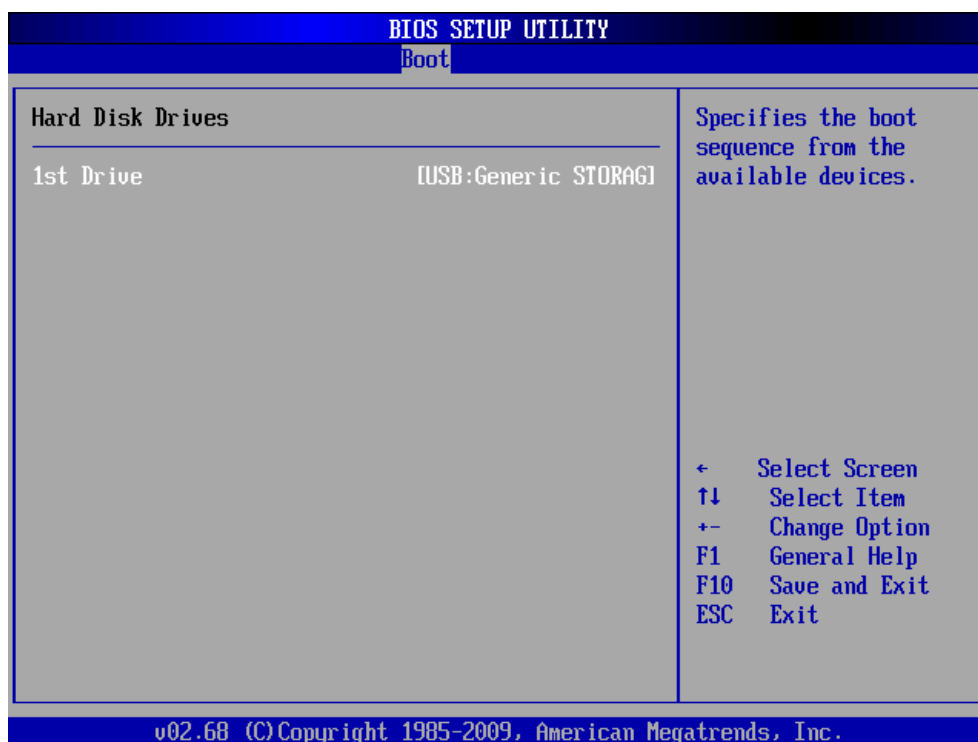

## ECM-PNV

### 4.6.4.4 Removable Drives

Use the Removable Drives menu to specify the boot sequence of the available FDDs.

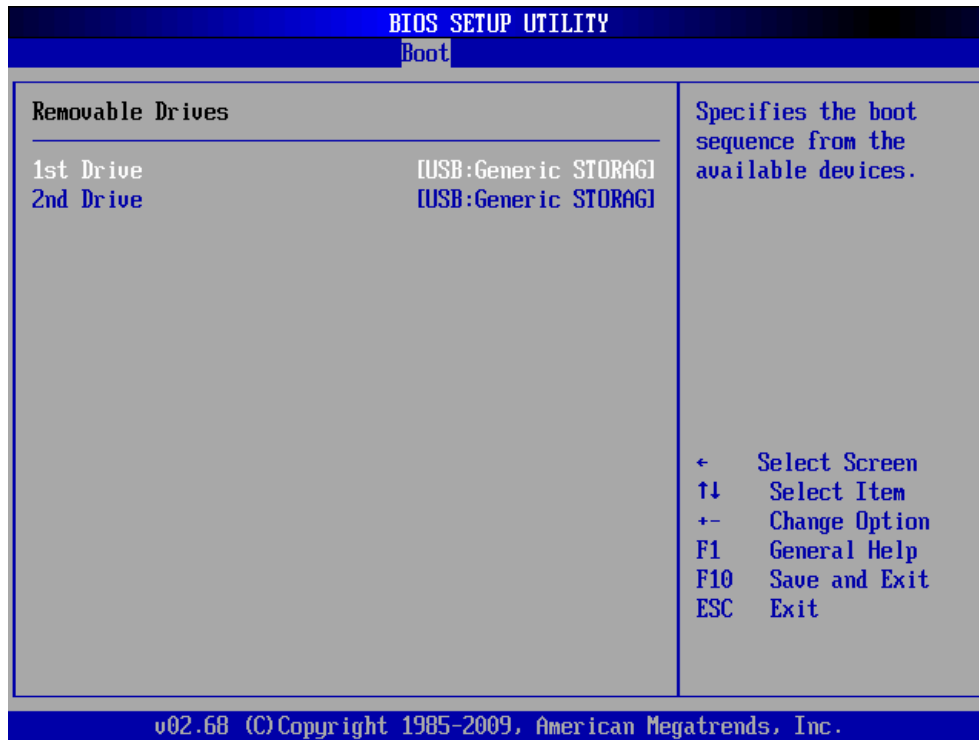

### 4.6.5 Security

Use the Security menu to set system and user password.

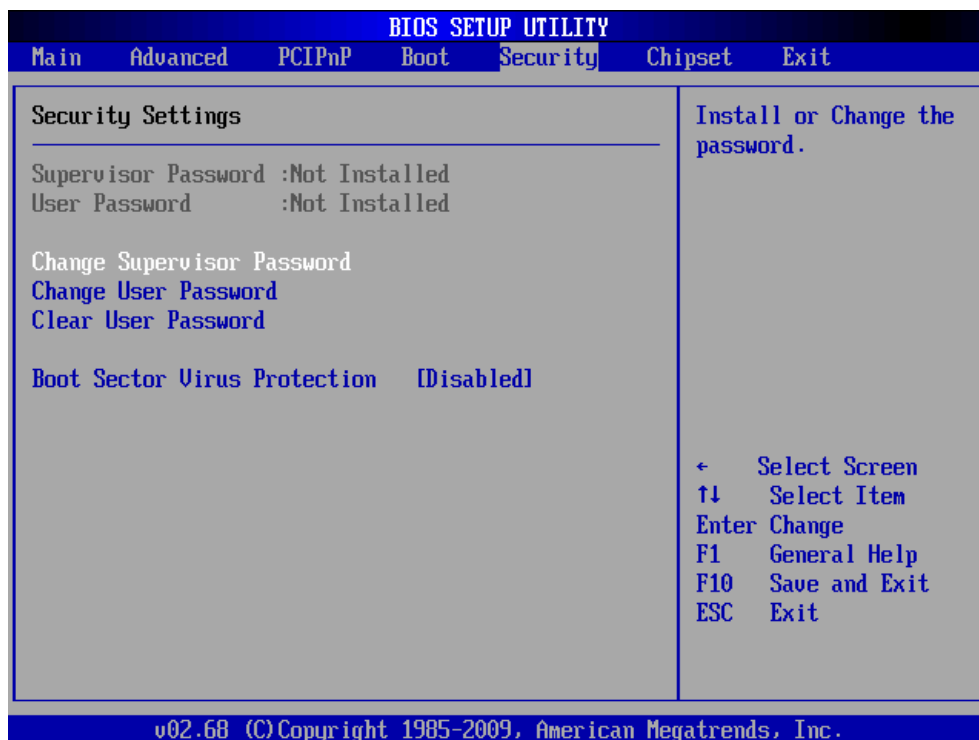

### 4.6.5.1 Change Supervisor/ User Password

Provides for either installing or changing the password.

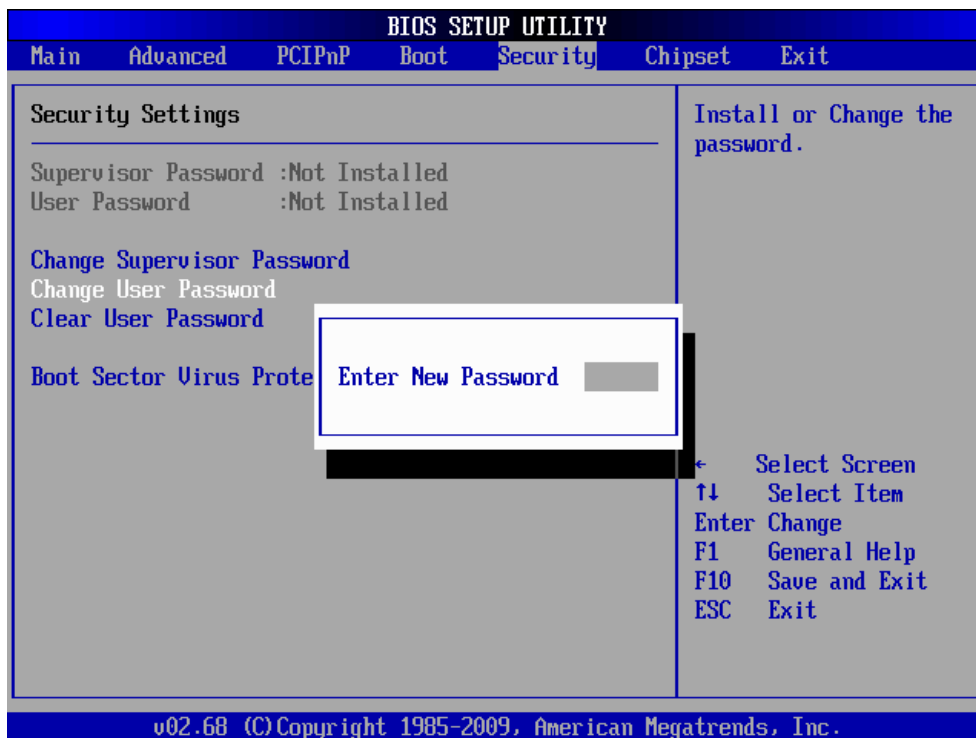
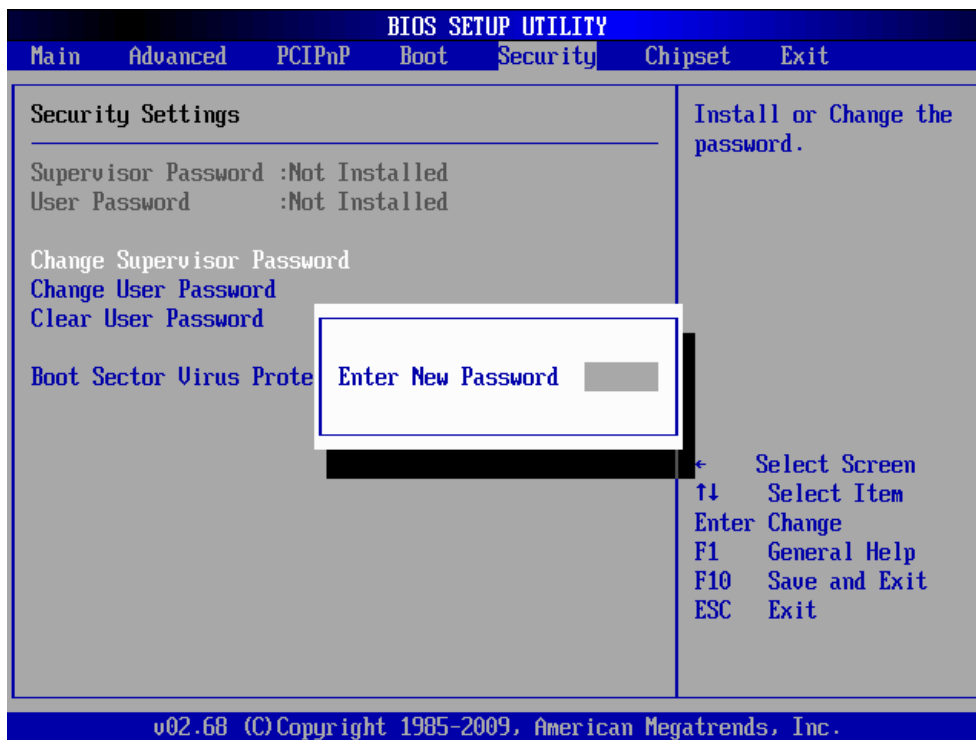

## ECM-PNV

### 4.6.5.2 Clear User Password

Use the Clear User Password to clean a user password.

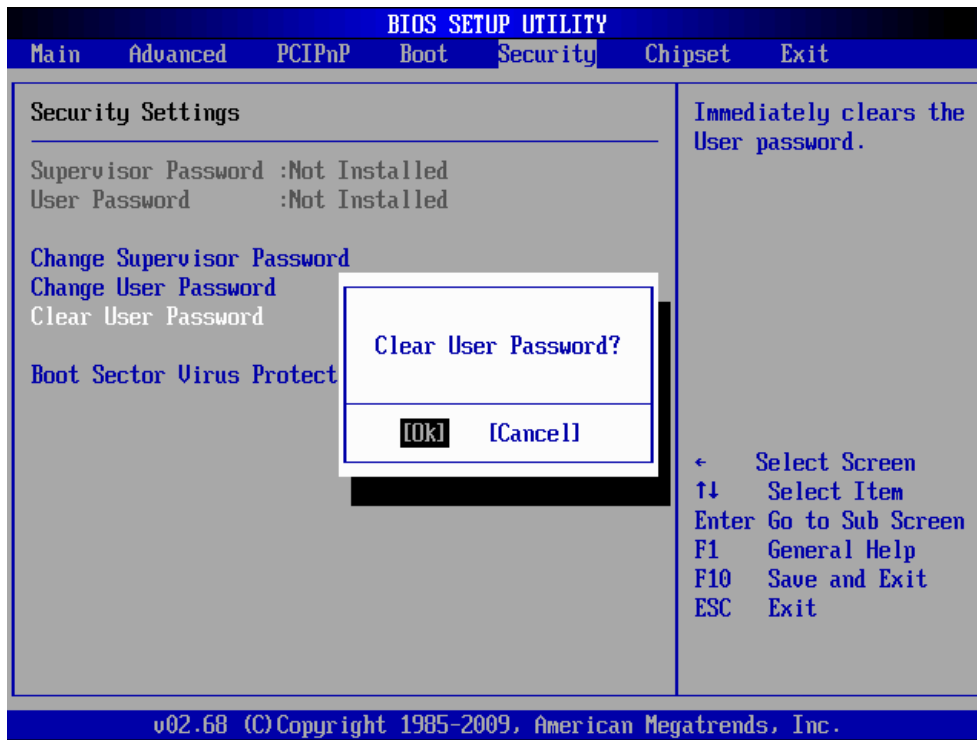

### 4.6.5.3 Boot Sector Virus Protection

The boot sector virus protection will warn if any program tries to write to the boot sector.

#### 4.6.6 Advanced Chipset Settings

Use the chipset menu to access the Northbridge and Southbridge configuration menus.



4.6.6.1 North Bridge Configuration

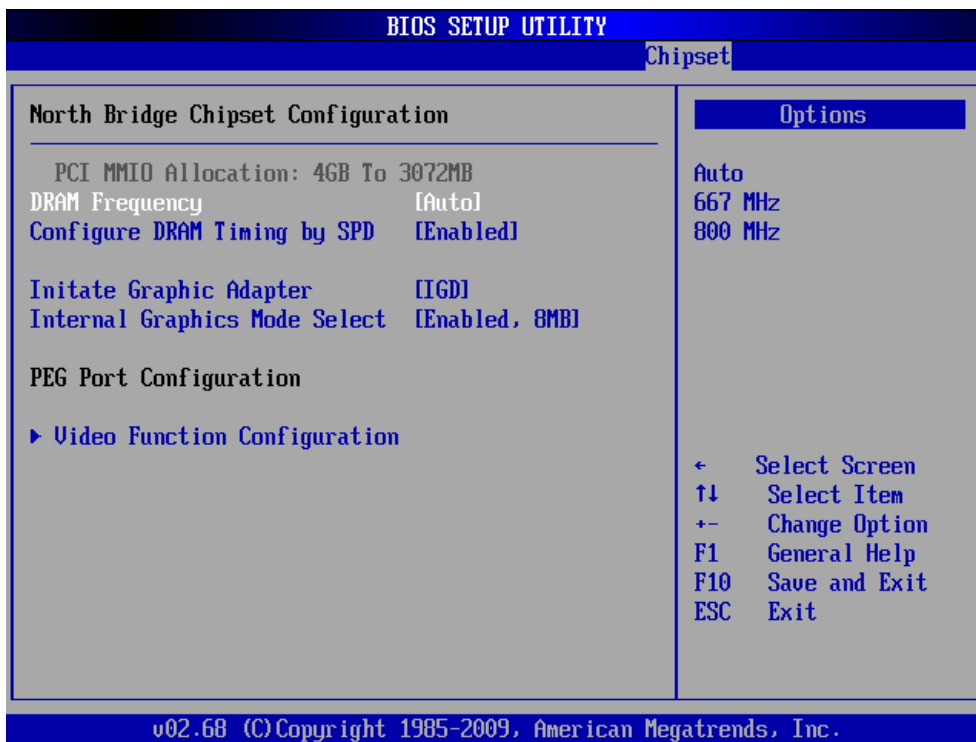

Item	Option	Description
<b>DRAM Frequency</b>	Auto, 667MHz, 800MHz	This item allows you to manually change DRAM frequency.
<b>Configure DRAM Timing by SPD</b>	Disabled, Enabled	This item allows you to enable or disable by DRAM SPD.
<b>Initiate Graphic Adapter</b>	IGD, PEG/IGD	This item allows you to select which graphics controller to use as the primary boot device.
<b>Internal Graphics Mode Select</b>	Disabled, Enabled 32MB, Enabled 64MB, Enabled 128MB	This option determines the amount of system memory that can be used by the internal graphics device.
<b>PEG Port Configuration</b>	Disabled, Enabled	Use the PEG Port option to enable or disable the PCI Express port.



## 4.6.6.1.1 Video Function Configuration

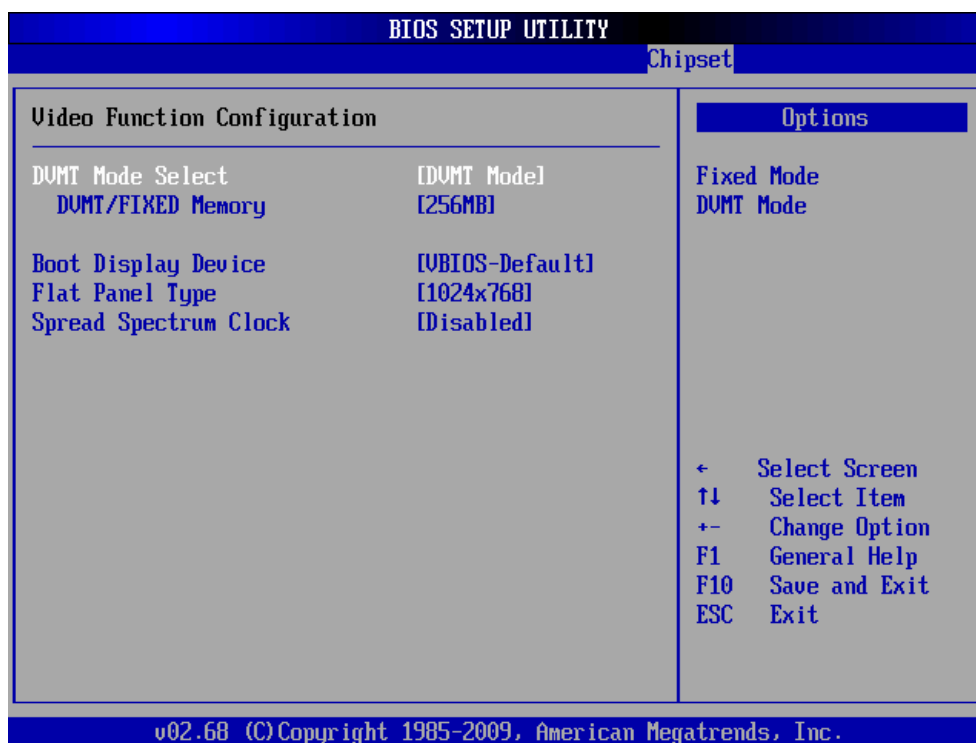

Item	Option	Description
<b>DVMT Mode Select</b>	Fixed Mode, DVMT Mode, Combo Mode	Displays the active system memory mode.
<b>DVMT/ FIXED Memory</b>	64MB, 128MB, Maximum DVMT	Specifies the amount of DVMT/ FIXED system memory to allocate for video memory.
<b>Boot Display Device</b>	VBIOS-Default, CRT, LVDS, CRT+LVDS	Select boot display device at post stage.

## ECM-PNV

<b>Flat Panel Type</b>	640 x 480, 800 x 600, 1024 x 768, 1024 x 600, 1024 x 576, 800 x 480, 1280 x 720, 1280 x 768, 800 x 600, 1024 x 600, 1024 x 768, 1024 x 768, 1024 x 768, 1280 x 800, 1280 x 600, 1366 x 768	This item allows you to select which panel resolution you want.
<b>Spread Spectrum Clock</b>	Disabled, Enabled	This item allows you to enable or disable spread spectrum clock.

### 4.6.6.2 South Bridge Configuration

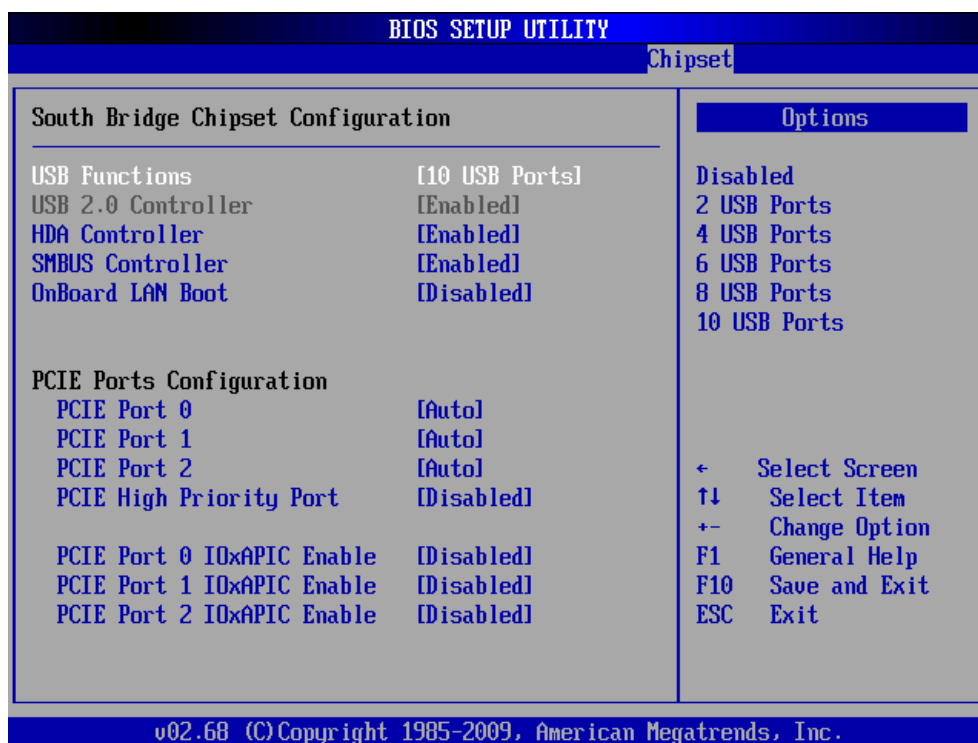

Item	Option	Description
<b>USB Functions</b>	Disables, 2/ 4/ 6/ 8/ 10 USB Ports	This option enables the number of USB ports desired or disables the USB function.
<b>USB 2.0 Controller</b>	Disabled, Enabled	This option is disabled by default.
<b>HAD Controller</b>	Disabled, Enabled	This option is used to enable the southbridge high definition audio controller.
<b>SMBUS Controller</b>	Disabled, Enabled	This option is enabled by default.
<b>OnBoard LAN Boot</b>	Disabled, Enabled	This item helps to set onboard LAN boot mode.
<b>PCIE Port 0/ 1/ 2</b>	Disabled, Enabled, Auto	This section allows selecting PCIE port 0/ 1/ 2 mode.
<b>PCIE High Priority Port</b>	Disabled, Enabled, Auto	This item helps to set PCIE high priority port.
<b>PCIE Port 0/ 1/ 2 IOxAPIC Enable</b>	Disabled, Enabled	This helps to enabled or disabled PCIE port 0/ 1/ 2 IOxAPIC.

## ECM-PNV

### 4.6.7 Exit Options

Use the Exit menu to load default BIOS values, optional failsafe values and to save configuration changes.

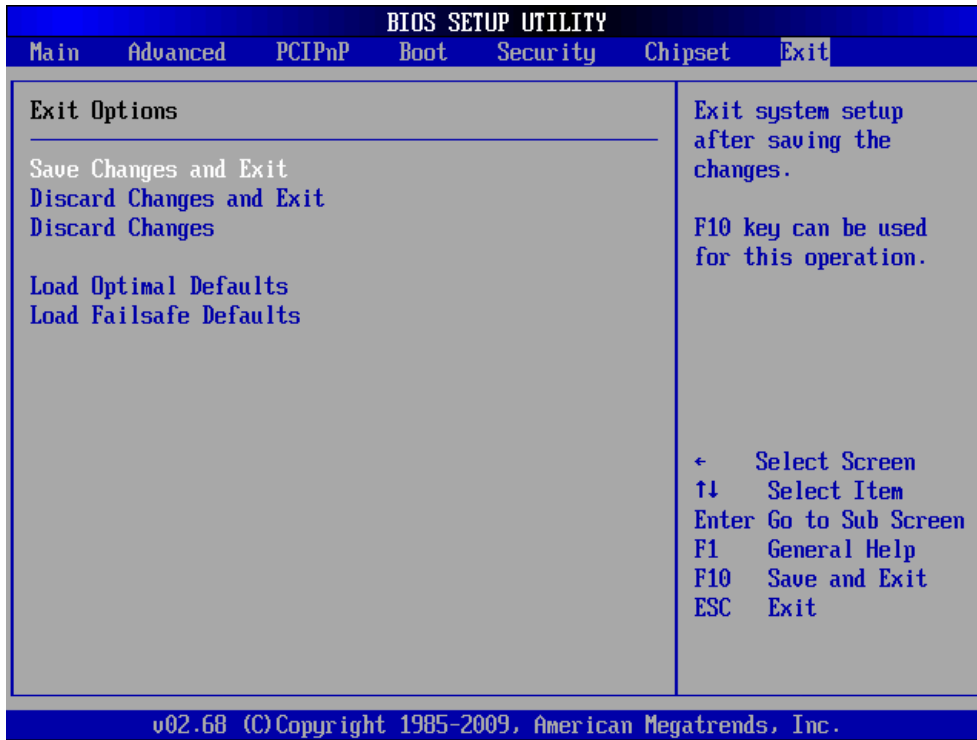

#### 4.6.7.1 Save changes and exit

Use the save changes and reset option to save the changes made to the BIOS options and to exit the BIOS configuration setup program.



### 4.6.7.2 Discard Changes and Exit

Use the Discard changes and Exit option to exit the system without saving the changes made to the BIOS configuration setup program.



### 4.6.7.3 Discard Changes

Use the Discard Changes option to discard the changes and remain in the BIOS configuration setup program.

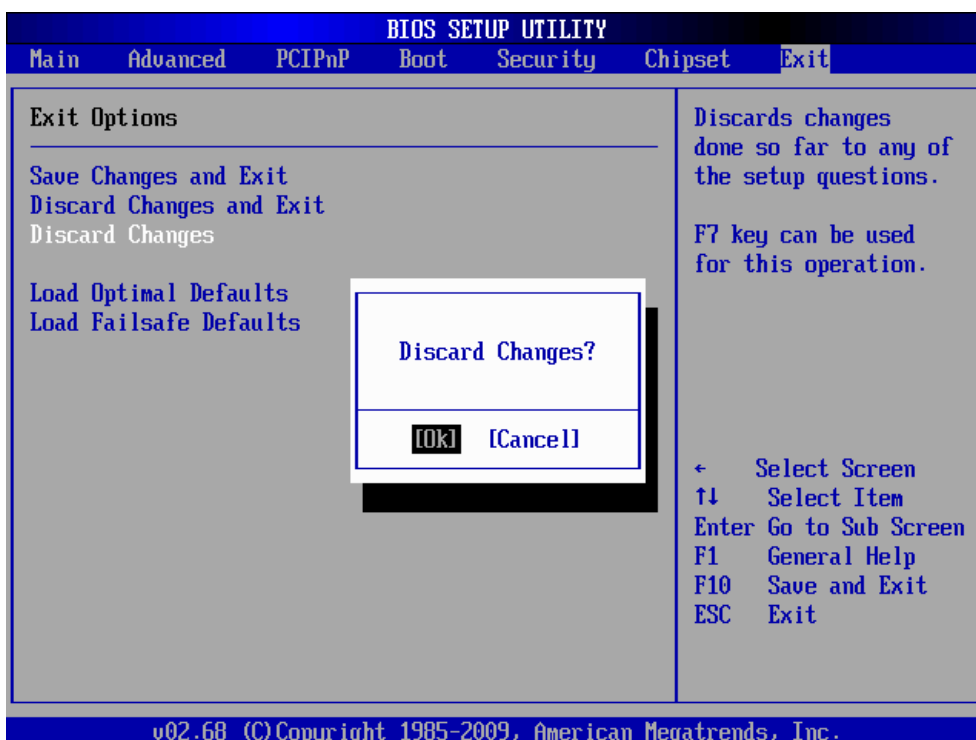

## ECM-PNV

### 4.6.7.4 Load Optimal Default

Use the Load Optimal Defaults option to load the optimal default values for each of the parameters on the setup menus. F9 key can be used for this operation.



### 4.6.7.5 Load Failsafe Defaults

Use the Load Failsafe Defaults option to load failsafe default values for each of the parameters on the Setup menus. F8 key can be used for this operation.

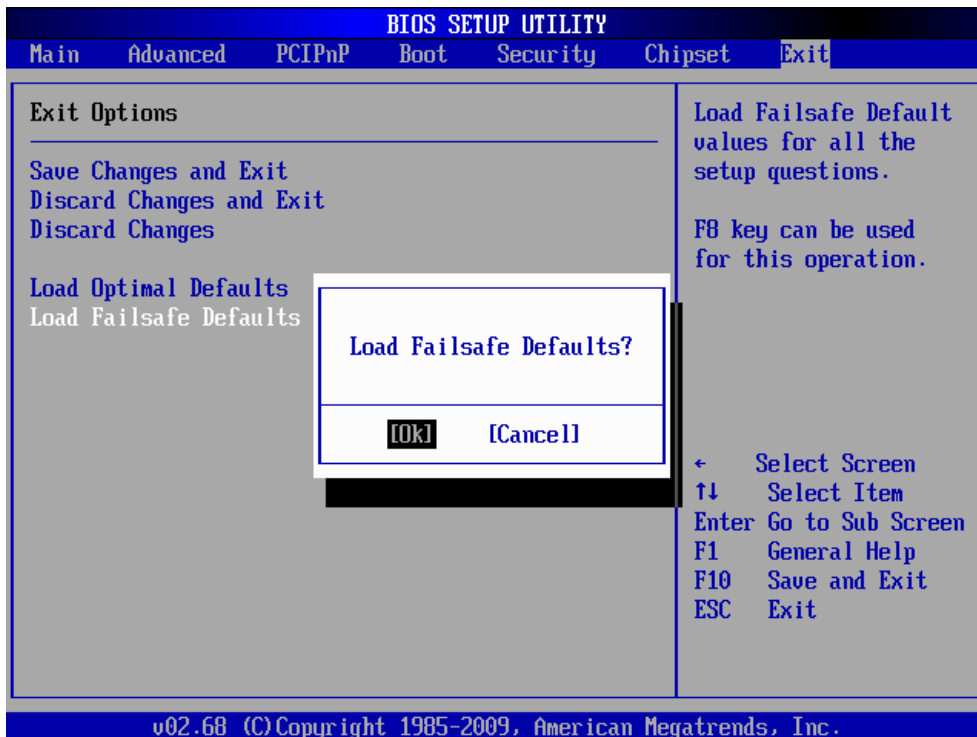

# 5. Drivers Installation

---



**Note:** Installation procedures and screen shots in this section are for your reference and may not be exactly the same as shown on your screen.

## 5.1 Install Display Driver (For Intel QM57)

Insert the Supporting DVD-ROM to DVD-ROM drive, and it should show the index page of Avalue's products automatically. If not, locate Index.htm and choose the product from the menu left, or link to \Driver\_Video\Intel\Pineview.



**Note:** The installation procedures and screen shots in this section are based on Windows XP operation system.

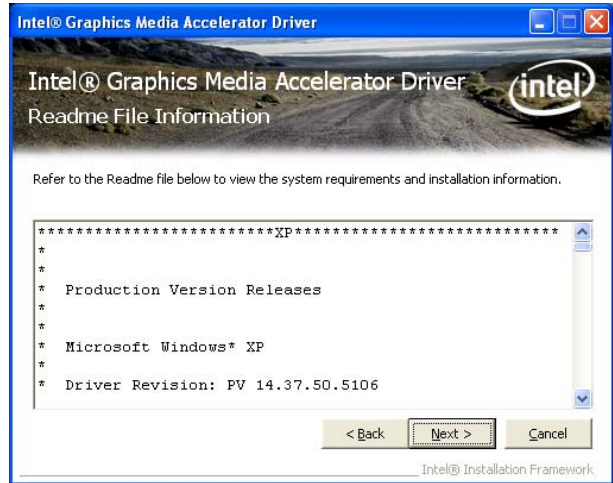

**Step 3. Click Next.**



**Step1. Click Next.**

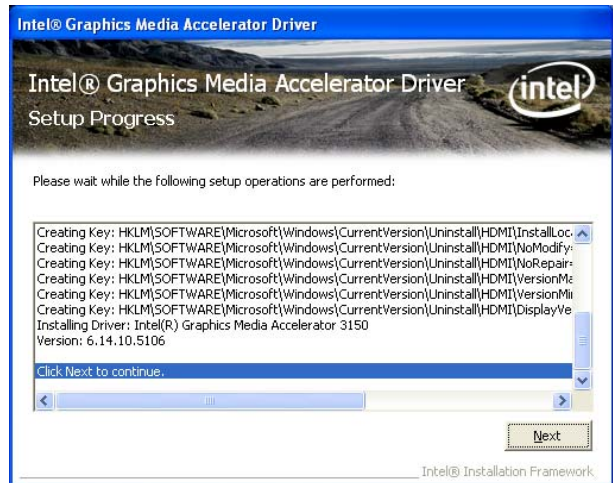

**Step 4. Click Next.**

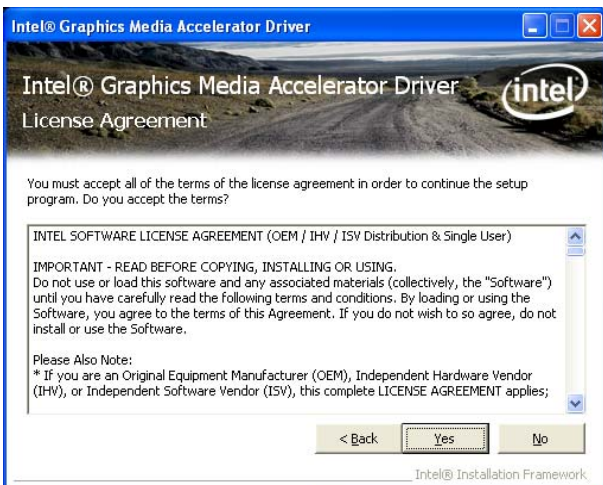

**Step 2. Click Yes.**



**Step 5. Click Finish to complete setup.**



## 5.2 Install Audio Driver (For Realtek ALC888)

Insert the Supporting CD-ROM to CD-ROM drive, and it should show the index page of Avalue's products automatically. If not, locate Index.htm and choose the product from the menu left, or link to **\Driver\_Audio\Realtek \ALC888**.



**Note:** The installation procedures and screen shots in this section are based on Windows 2000 operation system.

**Step 1.** Locate 「\Driver\_Audio\Intel\ALC888\setup.exe」.

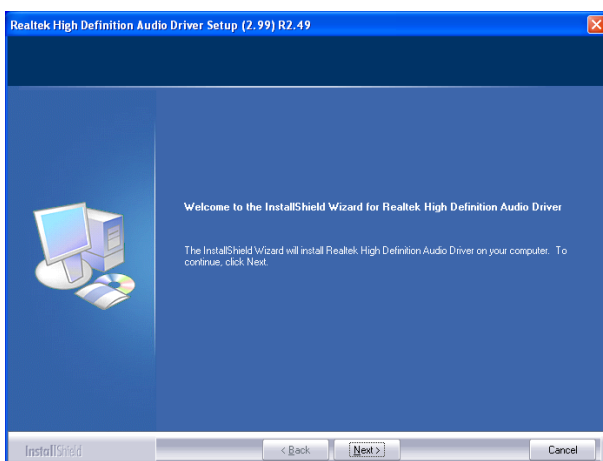

**Step 2.** Click **Next**.

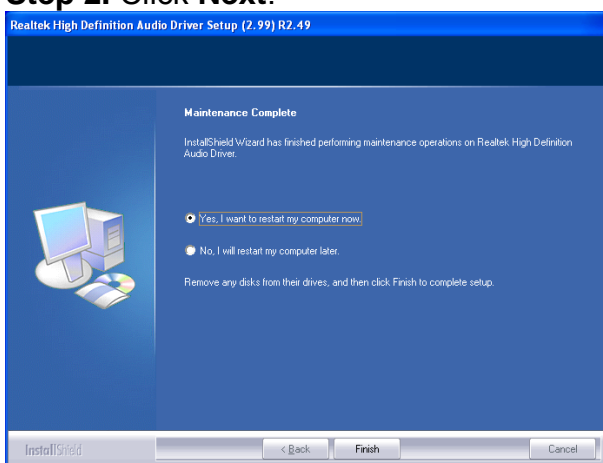

**Step 3.** Click **Finish** to complete the setup.

## 5.3 Install Ethernet Driver (For Intel 82574L)

Insert the Supporting DVD-ROM to DVD-ROM drive, and it should show the index page of Avalue's products automatically. If not, locate Index.htm and choose the product from the menu left, or link to **D:\Driver\_Gigabit\Intel\ 82574L**.



**Note:** The installation procedures and screen shots in this section are based on Windows XP operation system.

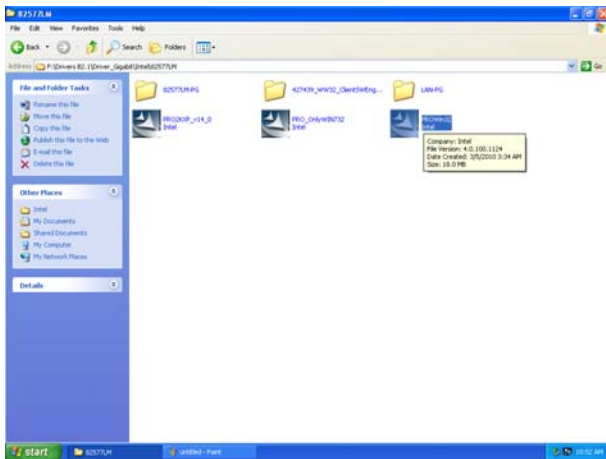

**Step 1.** Locate 「\Driver\_Gigabit\Intel\82574L」 and choose your system OS.

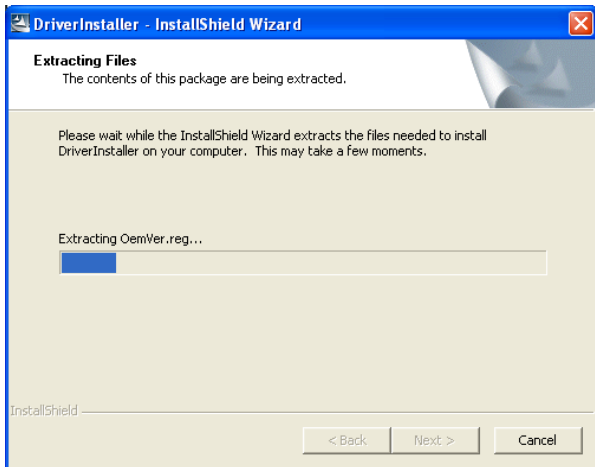

**Step 2.** Click **Next**.

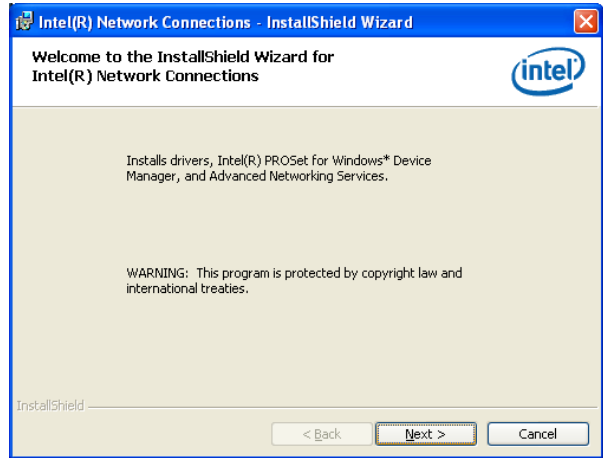

**Step 3.** Click **Next** to run the installation.

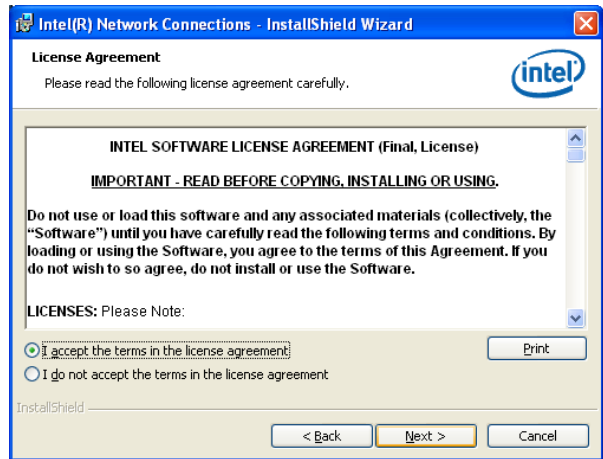

**Step 4.** Click **Accept** to continue.

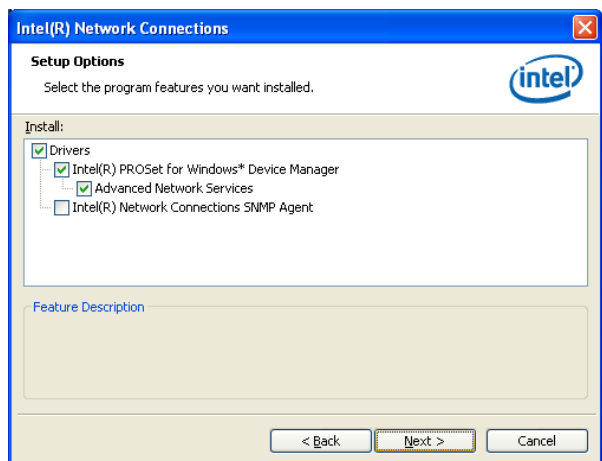

**Step 5.** Click **Next**.

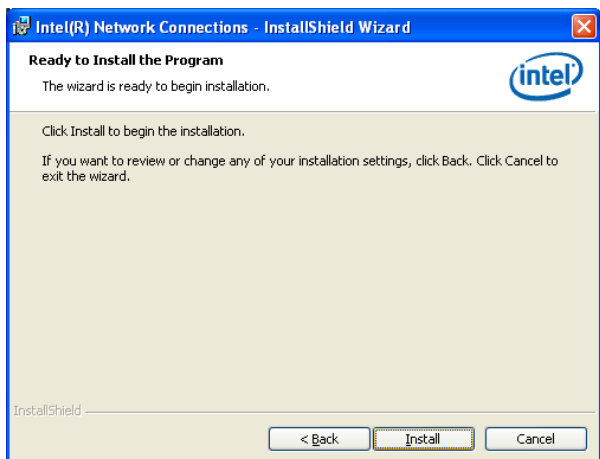

**Step 5.** Click **Install** to next step.

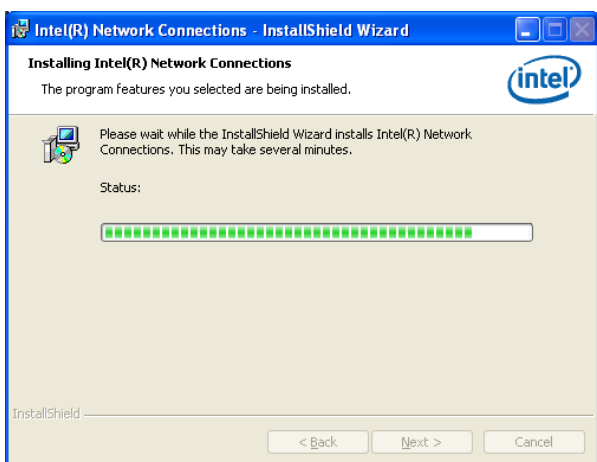

**Step 6.** Click **Next** to next step.

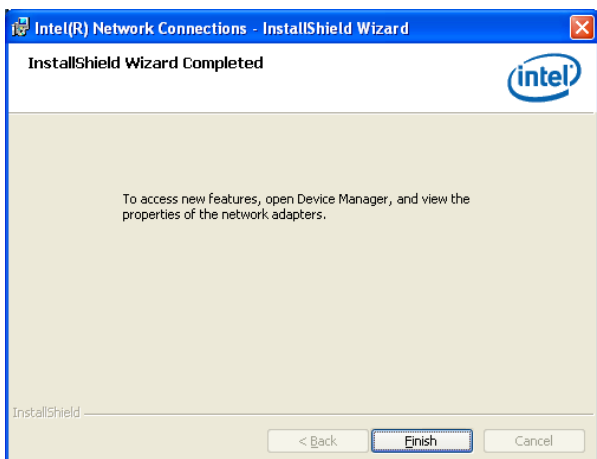

**Step 7.** Click **Finish** to complete the setup.

# 6. Mechanical Drawing

For Rev. A1



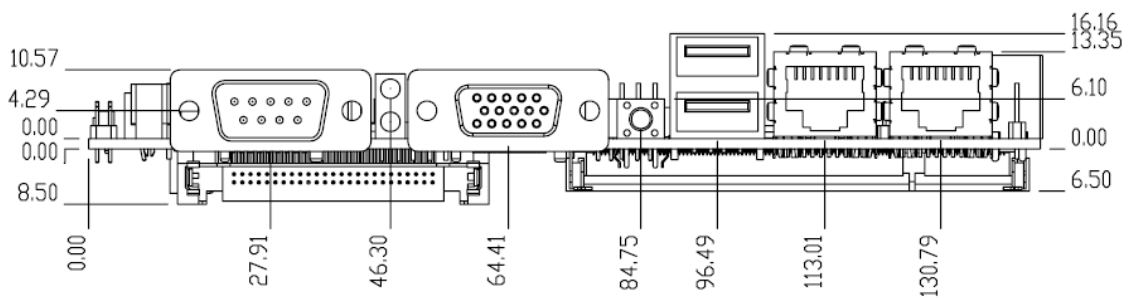
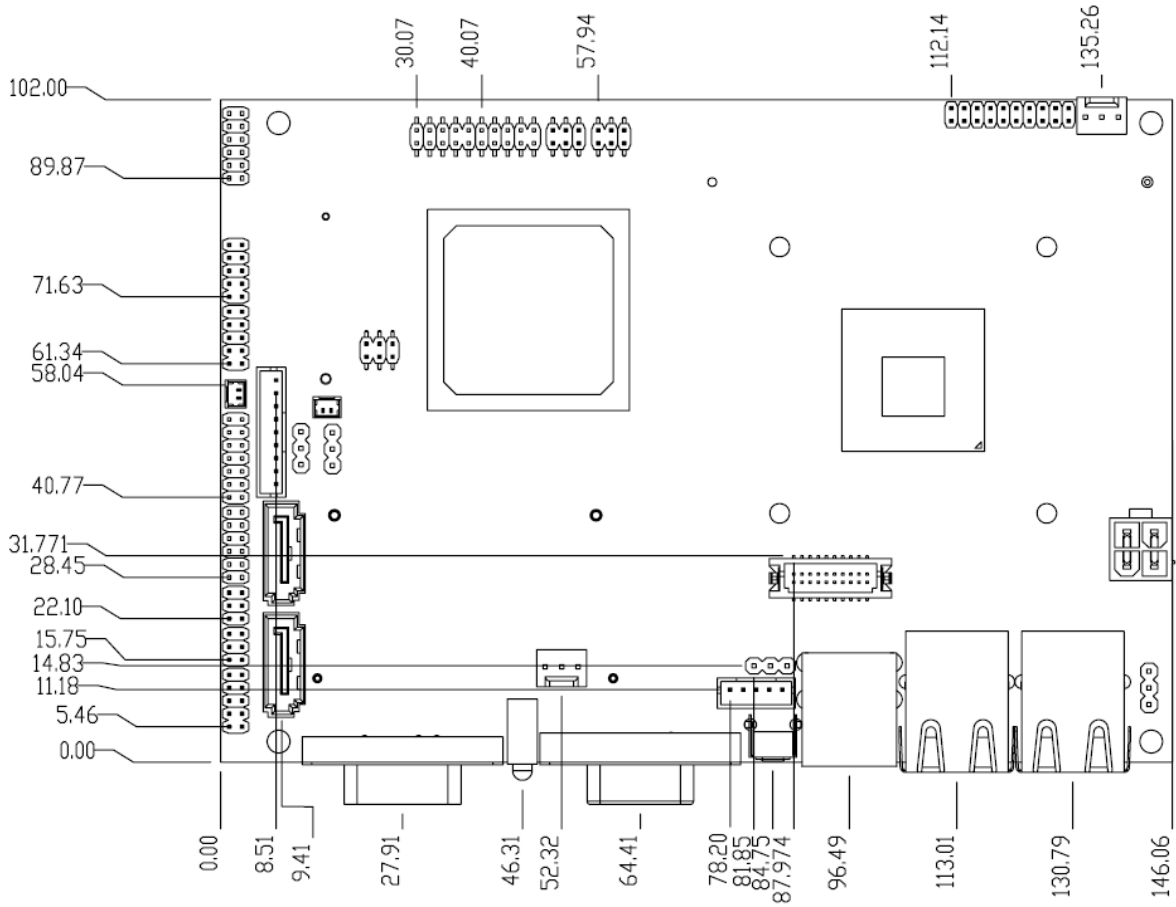

Unit: mm

# ECM-PNV

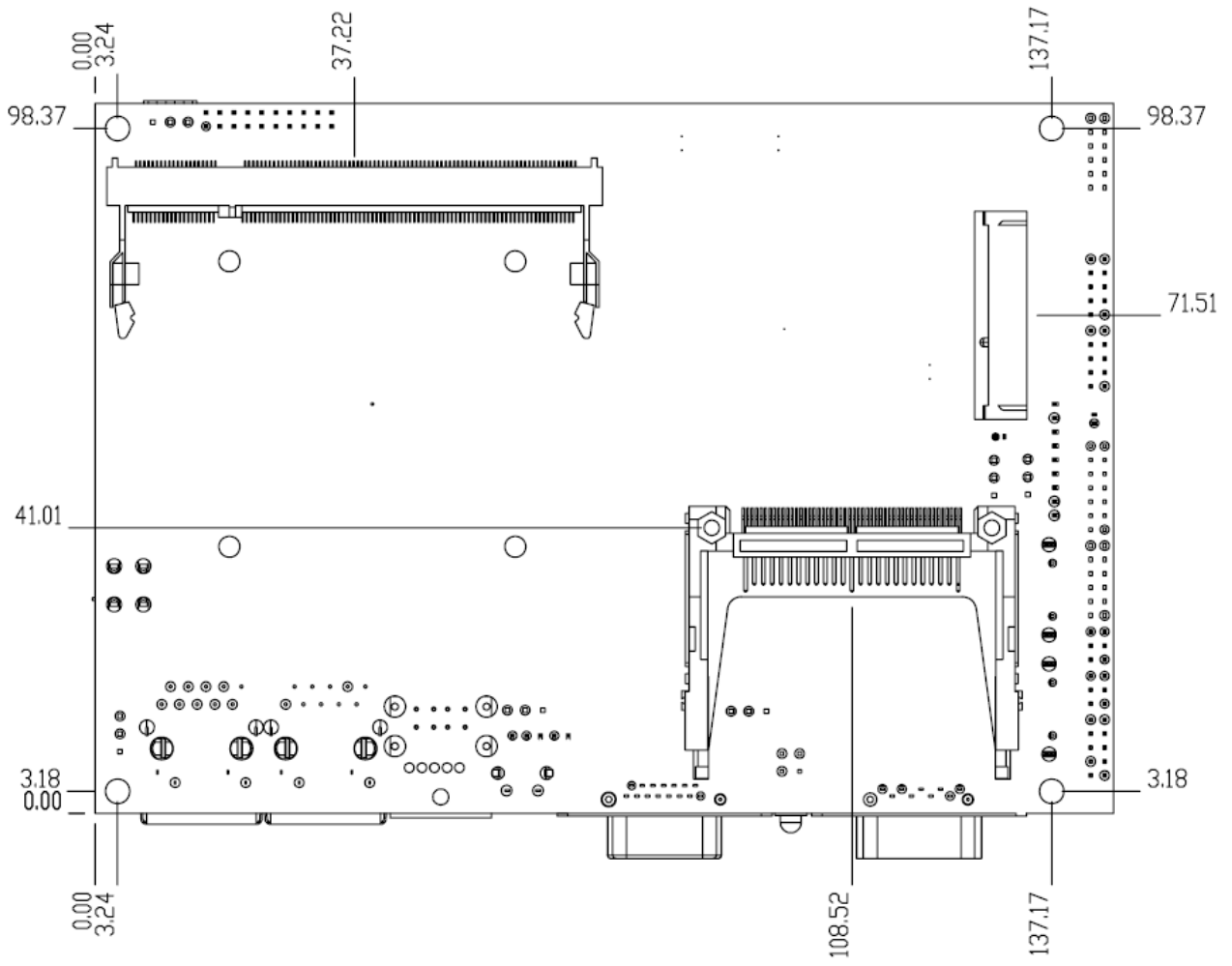

Unit: mm

# 7. Mechanical Drawing

For Rev. B1



# ECM-PNV

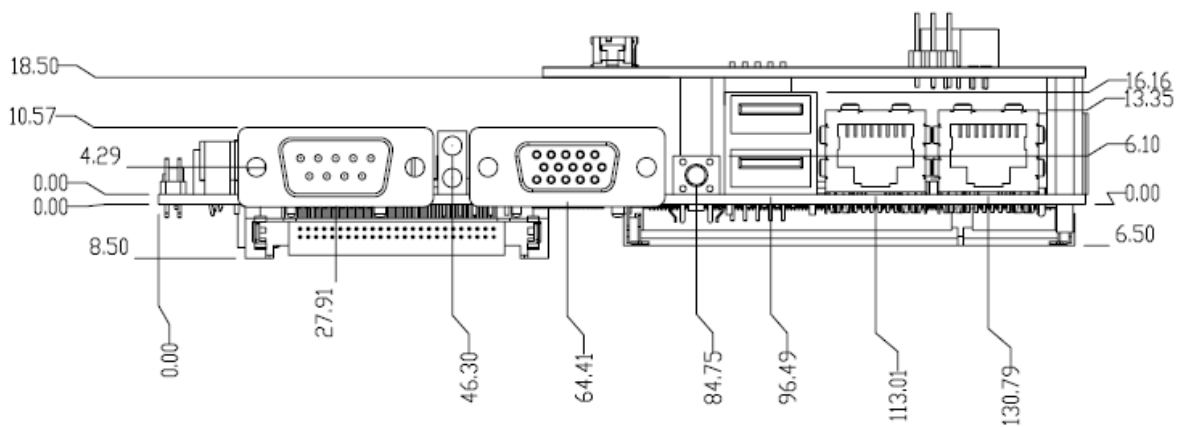
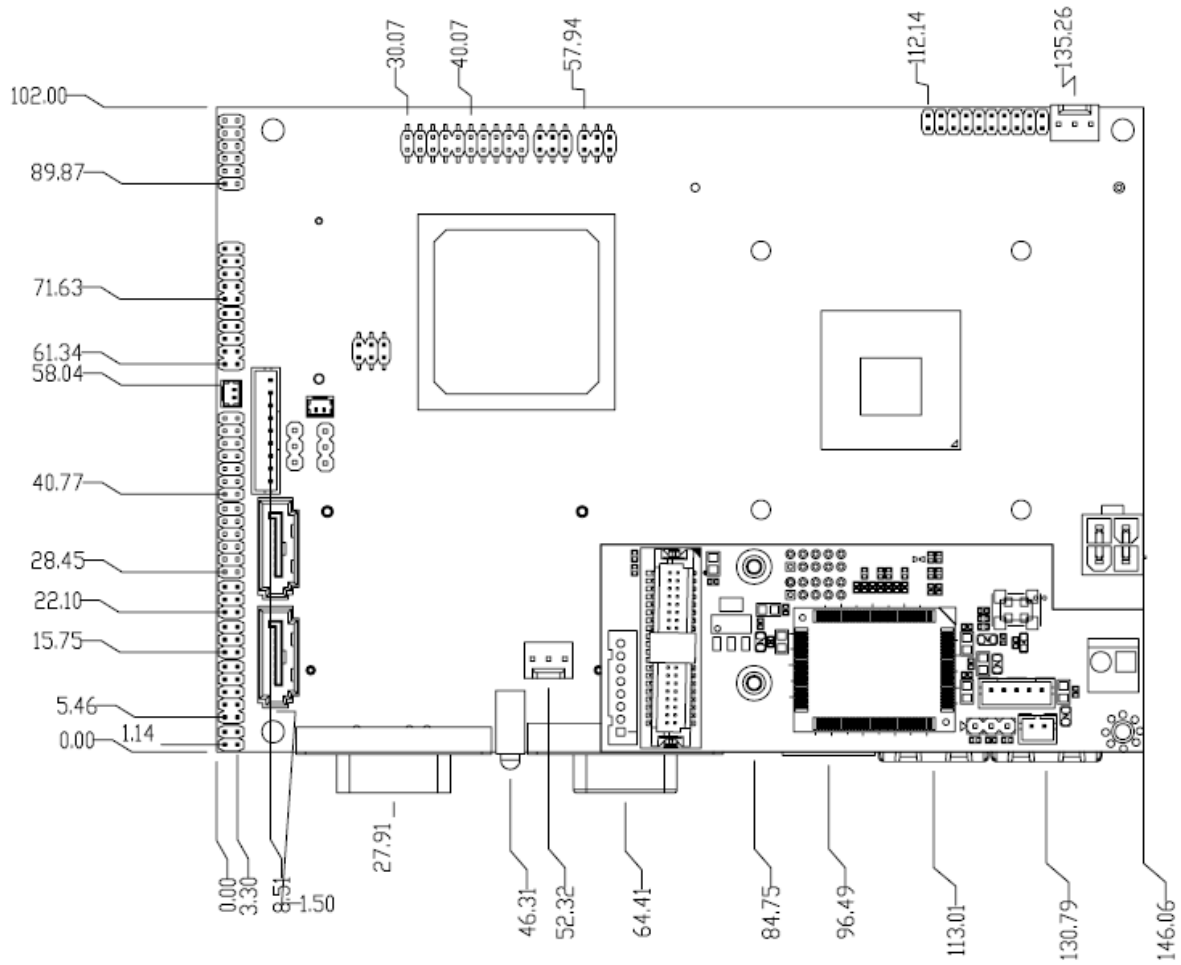

Unit: mm



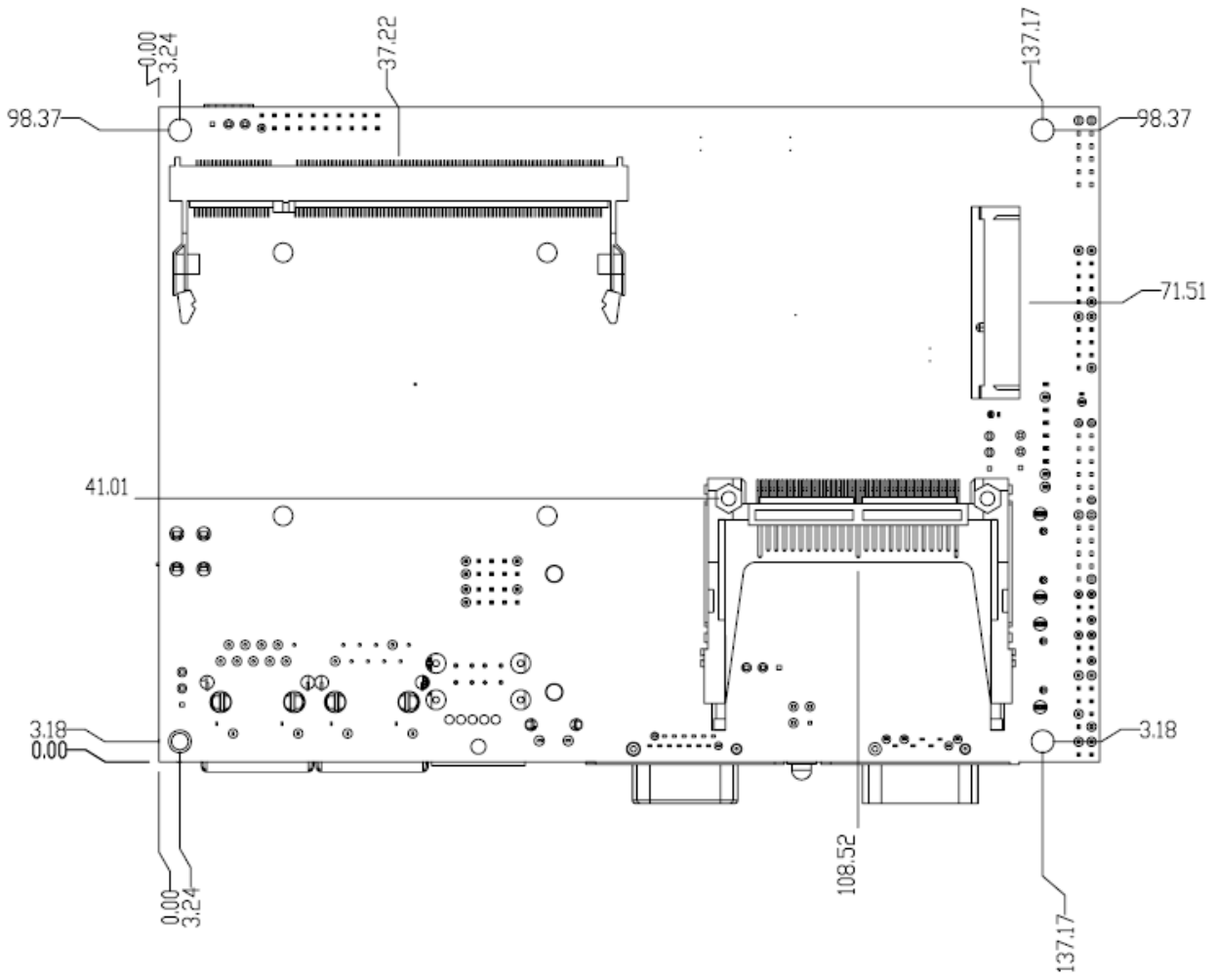

Unit: mm