

# ECM-DX2

DX&P Vortex86DX2  
3.5" Micro Module

## Quick Installation Guide



1<sup>st</sup> Ed – 25 December 2013

### FCC Statement



THIS DEVICE COMPLIES WITH PART 15 FCC RULES. OPERATION IS SUBJECT TO THE FOLLOWING TWO CONDITIONS:

(1) THIS DEVICE MAY NOT CAUSE HARMFUL INTERFERENCE.

(2) THIS DEVICE MUST ACCEPT ANY INTERFERENCE RECEIVED INCLUDING INTERFERENCE THAT MAY CAUSE UNDESIRE OPERATION.

THIS EQUIPMENT HAS BEEN TESTED AND FOUND TO COMPLY WITH THE LIMITS FOR A CLASS "A" DIGITAL DEVICE, PURSUANT TO PART 15 OF THE FCC RULES.

THESE LIMITS ARE DESIGNED TO PROVIDE REASONABLE PROTECTION AGAINST HARMFUL INTERFERENCE WHEN THE EQUIPMENT IS OPERATED IN A COMMERCIAL ENVIRONMENT. THIS EQUIPMENT GENERATES, USES, AND CAN RADIATE RADIO FREQUENCY ENERGY AND, IF NOT INSTALLED AND USED IN ACCORDANCE WITH THE INSTRUCTION MANUAL, MAY CAUSE HARMFUL INTERFERENCE TO RADIO COMMUNICATIONS.

OPERATION OF THIS EQUIPMENT IN A RESIDENTIAL AREA IS LIKELY TO CAUSE HARMFUL INTERFERENCE IN WHICH CASE THE USER WILL BE REQUIRED TO CORRECT THE INTERFERENCE AT HIS OWN EXPENSE.

### A Message to the Customer

#### *Avalue Customer Services*

Each and every Avalue's product is built to the most exacting specifications to ensure reliable performance in the harsh and demanding conditions typical of industrial environments. Whether your new Avalue device is destined for the laboratory or the factory floor, you can be assured that your product will provide the reliability and ease of operation for which the name Avalue has come to be known.

Your satisfaction is our primary concern. Here is a guide to Avalue's customer services. To ensure you get the full benefit of our services, please follow the instructions below carefully.

#### *Technical Support*

We want you to get the maximum performance from your products. So if you run into technical difficulties, we are here to help. For the most frequently asked questions, you can easily find answers in your product documentation. These answers are normally a lot more detailed than the ones we can give over the phone. So please consult the user's manual first.

To receive the latest version of the user's manual; please visit our Web site at:

<http://www.avalue.com.tw/>

# 1. Getting Started

## 1.1 Safety Precautions

### Warning!



Always completely disconnect the power cord from your chassis whenever you work with the hardware. Do not make connections while the power is on. Sensitive electronic components can be damaged by sudden power surges. Only experienced electronics personnel should open the PC chassis.

### Caution!



Always ground yourself to remove any static charge before touching the CPU card. Modern electronic devices are very sensitive to static electric charges. As a safety precaution, use a grounding wrist strap at all times. Place all electronic components in a static-dissipative surface or static-shielded bag when they are not in the chassis.

## 1.2 Packing List

Before you begin installing your single board, please make sure that the following materials have been shipped:

- 1 x 3.5" ECM-DX2 Micro Module
- 1 x Quick Installation Guide for ECM-DX2
- 1 x AUX-032 daughter board
- 1 x DVD-ROM contains the followings:
  - User's Manual (this manual in PDF file)
  - Ethernet driver and utilities
  - VGA drivers and utilities
  - Audio drivers and utilities
- 1 x Cable set contains the followings:
  - 1 x PS/2 Keyboard & mouse Y cable (6-pin,Mini-DIN)
  - 1 x Audio cable (12pin,2.0 pitch)
  - 1 x USB cable (10P/2.0mm-10P/2.0mm)
  - 1 x Serial ATA cable (7-pin, standard)
  - 1 x Flat cable 9P(M)-PHD 10P/2.0mm)
- 3M foam (VHB-4622 10mm\*20mm\*1.1mm)

# 2. Hardware Configuration

---

## 2.1 Product Overview

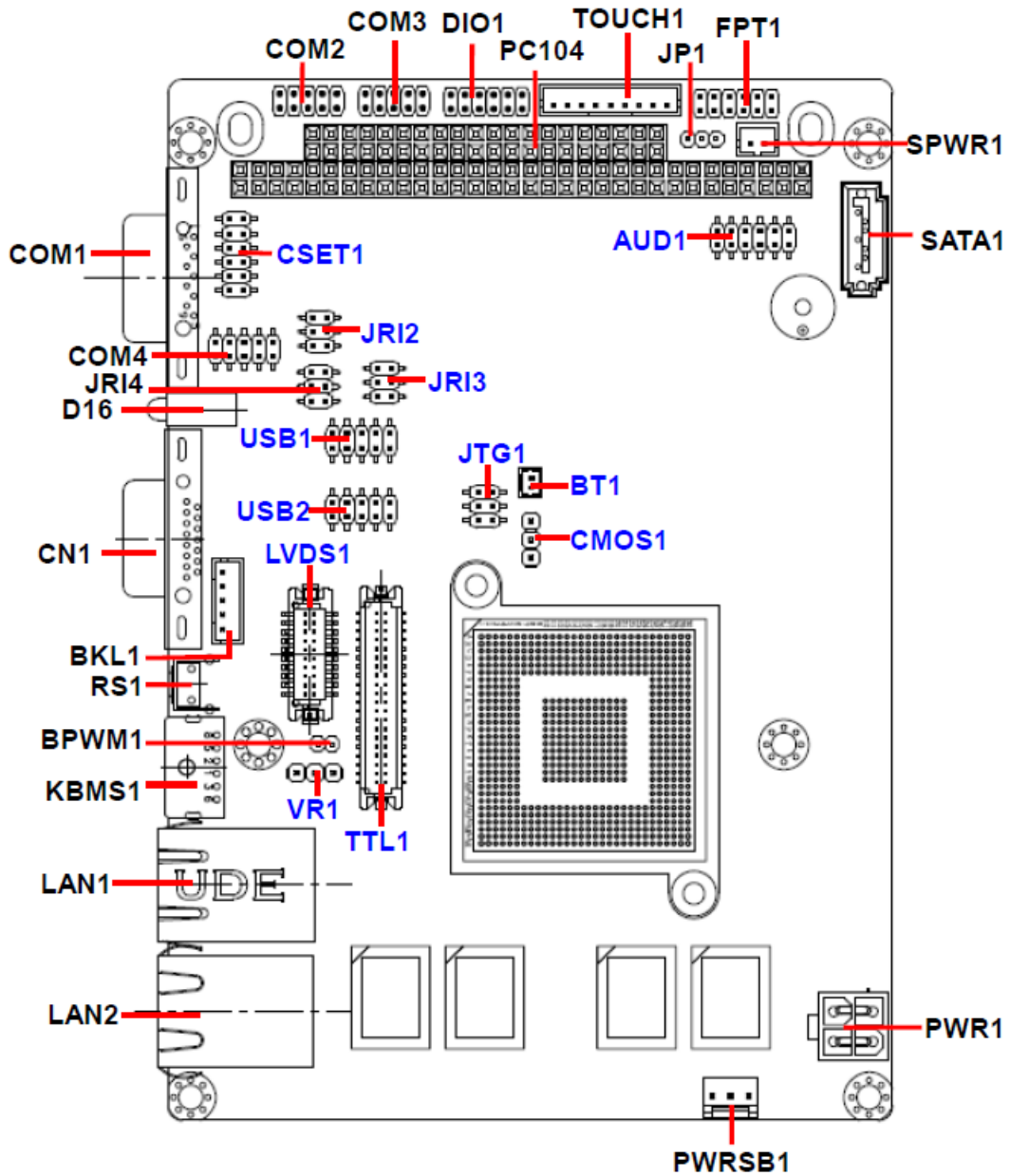

# ECM-DX2 Quick Installation Guide

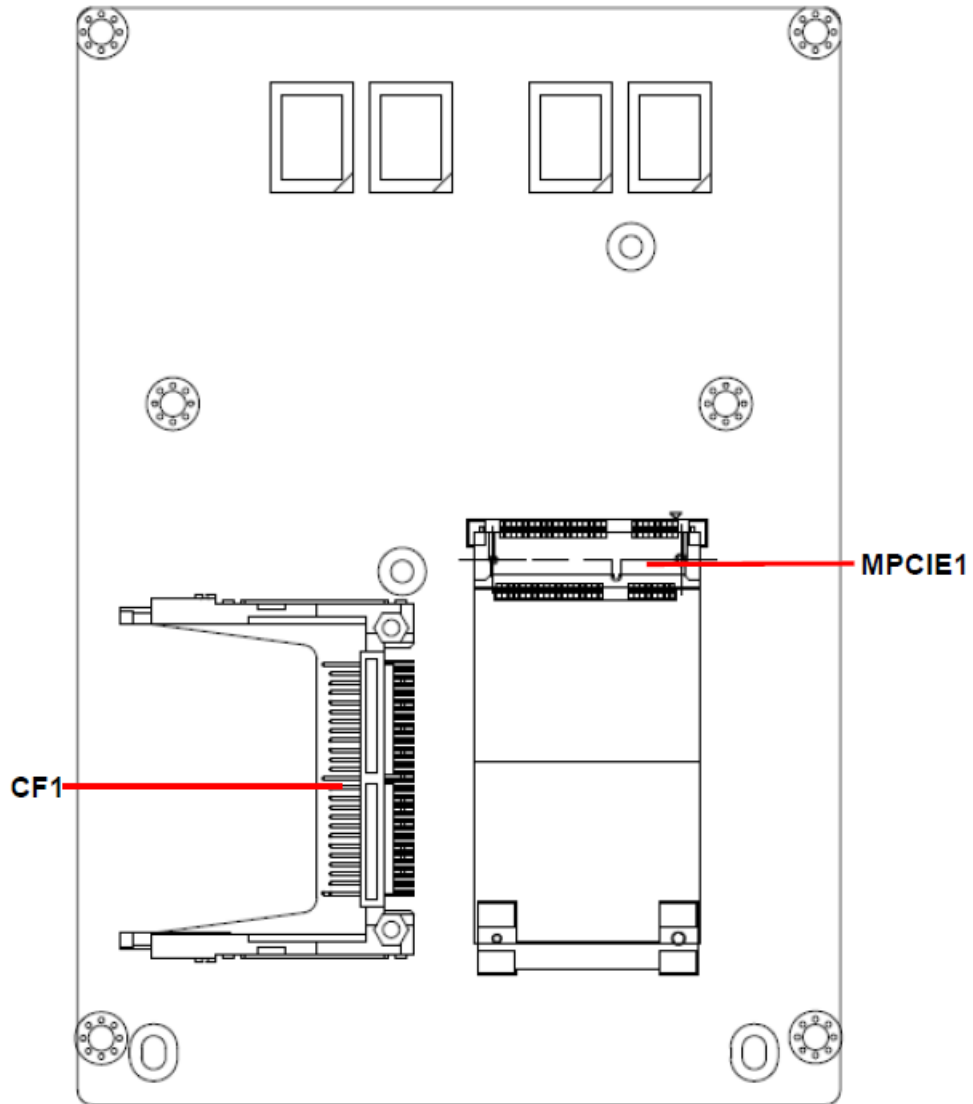

## 2.2 Jumper and Connector List

You can configure your board to match the needs of your application by setting jumpers. A jumper is the simplest kind of electric switch.

It consists of two metal pins and a small metal clip (often protected by a plastic cover) that slides over the pins to connect them. To “close” a jumper you connect the pins with the clip. To “open” a jumper you remove the clip. Sometimes a jumper will have three pins, labeled 1, 2, and 3. In this case, you would connect either two pins.

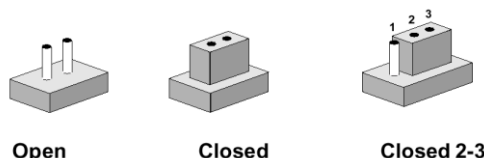

The jumper settings are schematically depicted in this manual as follows:



A pair of needle-nose pliers may be helpful when working with jumpers.

Connectors on the board are linked to external devices such as hard disk drives, a keyboard, or floppy drives. In addition, the board has a number of jumpers that allow you to configure your system to suit your application.

If you have any doubts about the best hardware configuration for your application, contact your local distributor or sales representative before you make any changes.

The following tables list the function of each of the board’s jumpers and connectors.

### Jumpers

Label	Function	Note
CMOS1	Clear CMOS	3 x 1 header, pitch 2.54 mm
FPT1	AT/ ATX Input power select	6 x 2 header, pitch 2.00 mm
JP1	Touch connector select jumper	3 x 1 header, pitch 2.00 mm
JRI2/3/4	COM 2/3/4 pin 9 signal select	3 x 2 header, pitch 2.00 mm
CSET1	Serial port in RS232/422/485 mode connector	6 x 2 header, pitch 2.00 mm

### Connectors

Label	Function	Note
TOUCH1	Touch connector	9 x 1 wafer, pitch 2.00 mm
BT1	Battery connector	2 x 1 wafer, pitch 1.25 mm

## ECM-DX2 Quick Installation Guide

<b>SPWR1</b>	SATA Power connector	2 x 1 wafer, pitch 2.00 mm
<b>PC-104</b>	PC-104 connector	20 x 2 header, pitch 2.54mm
<b>PC-104</b>	PC-104 connector	32 x 2 header, pitch 2.54mm
<b>JTG1</b>	Reserved for Debug	3 x 2 header, pitch 2.00 mm
<b>AUD1</b>	Audio connector	6 x 2 header, pitch 2.00 mm
<b>BKL1</b>	LCD inverter connector	5 x 1 wafer, pitch 2.00 mm
<b>COM1</b>	Serial port 1 connector	D-sub 9-pin, male
<b>COM2/3/4</b>	Serial port 2/3/4 connector	5 x 2 header, pitch 2.00 mm
<b>DIO1</b>	General purpose I/O connector	6 x 2 header, pitch 2.00 mm
<b>TTL1</b>	TFT panel connector	20 x 2 wafer, pitch 1.25 mm
<b>VR1</b>	LCD backlight brightness adjustment connector	3 x 1 header, pitch 2.54 mm
<b>LVDS1</b>	LVDS connector	10 x 2 wafer, pitch 1.25 mm
<b>BPWM1</b>	LCD PWM Mode Selector	2 x 1 header, pitch 2.00mm
<b>RS1</b>	Reset button	
<b>USB1/2</b>	On-board pin header for USB2.0	5 x 2 header, pitch 2.00 mm
<b>LAN1/2</b>	RJ-45 Ethernet connector	
<b>D16</b>	LED connector	
<b>PWRSB1</b>	5VSB connector in ATX	3 x 1 wafer, pitch 2.54 mm
<b>PWR1</b>	Power connector	2 x 2 wafer, pitch 4.20 mm
<b>KBMS1</b>	PS/2 keyboard & mouse connector	
<b>SATA1</b>	Serial ATA connector 1	
<b>CN1</b>	VGA connector	D-sub 15-pin, female
<b>MPCIE1</b>	Mini-PCI connector	
<b>CF1</b>	CF card slot	

### Limitation:

1. Attach a modem to COM2/COM3 when the modem power is off would result in OS to be freezed in Windows XP logo.

Power on the modem would continue to complete Windows booting process.

2. Text in in DOS might be out of screen at random.

3. Resolution needs to be set correctly in case of screen ambiguity in Windows 2000 after the graphic driver installation.

4. Link LED keeps the same green color in both 10M/100Mbps for DM&P Vortex86DX LAN chip.

5. HDD LED is working functionally when reading/writing CF cards, but fails in SATA devices.



## 2.3 Setting Jumpers & Connectors

### 2.3.1 Clear CMOS (CMOS1)

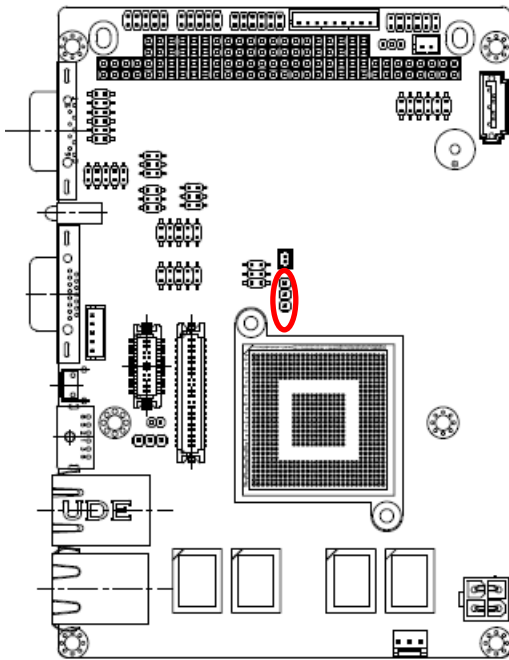

Normal\*

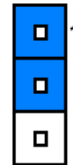

CMOS Clear

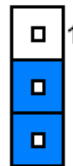

\* Default

### 2.3.2 Touch connector select jumper (JP1)

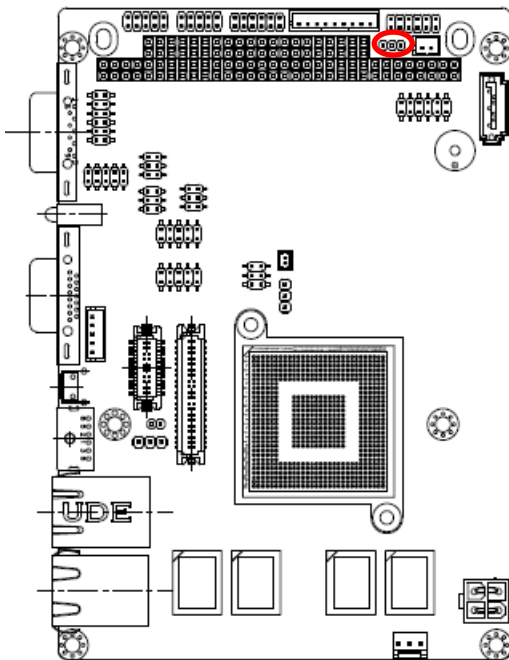

5W\*

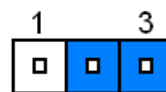

4W

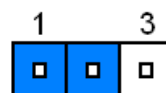

\* Default

# ECM-DX2 Quick Installation Guide

## 2.3.3 Serial port in RS232/422/485 mode connector (CSET1)

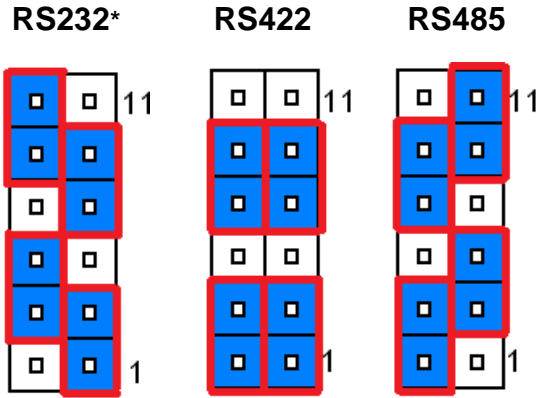
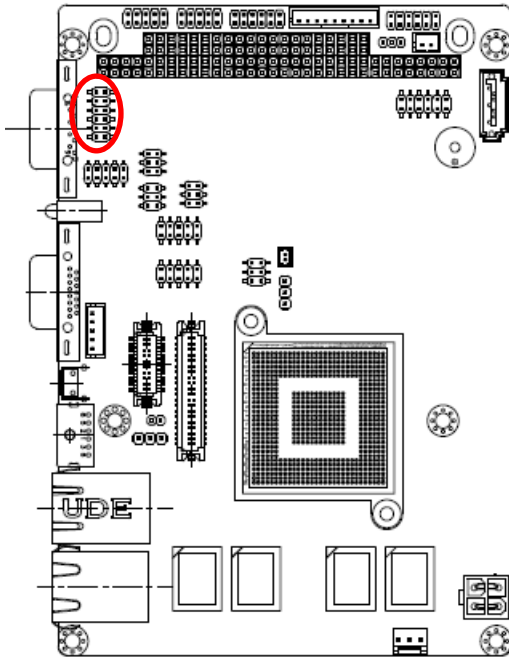

Signal	PIN	PIN	Signal
COM3_M1_EN	12	11	GND
+5V	10	9	COM3_M0
SUS_LED#	8	7	COM3_M0_H
COM2_M1_EN	6	5	GND
+5V	4	3	COM2_M0
NRX2#	2	1	COM2_M0_H

\* Default

## 2.3.4 AT/ ATX Input power select (FPT1)

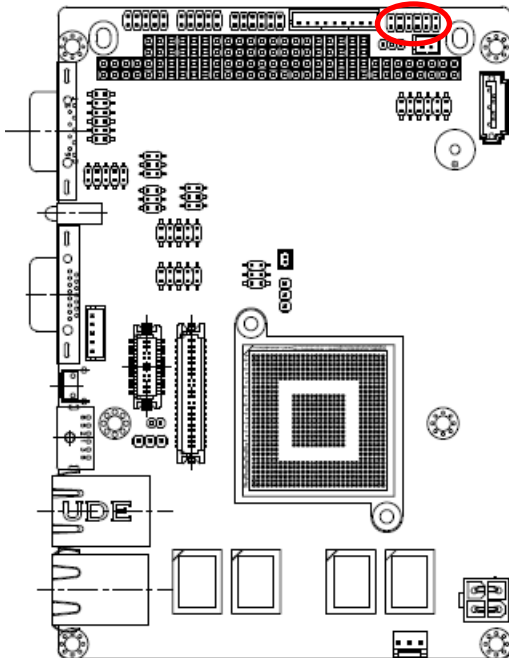

ATX\*

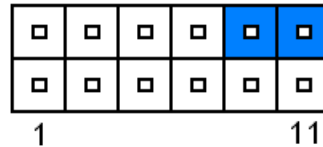

AT

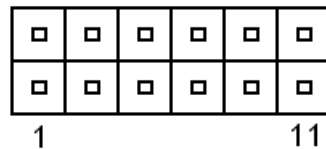

Signal	PIN	PIN	Signal
HDD_LED+	1	2	PWR_LED+
HDD_LED#	3	4	GND
GND	5	6	SUS_LED+
SYS_RST#	7	8	SUS_LED#
PWR_BTN#	9	10	PS_ON_EN
GND	11	12	GND

\* Default

# ECM-DX2 Quick Installation Guide

## 2.3.5 COM 2/4 pin 9 signal select (JRI2/4)

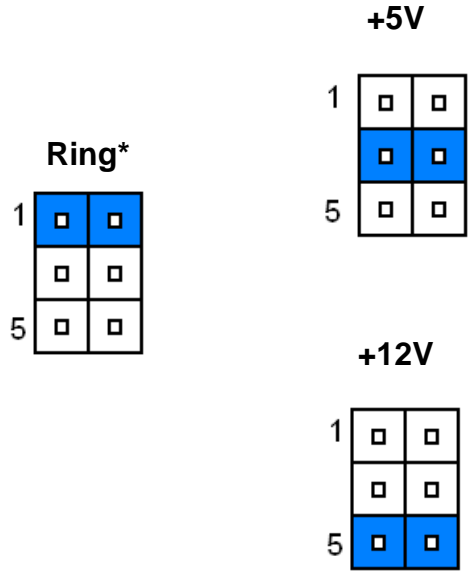
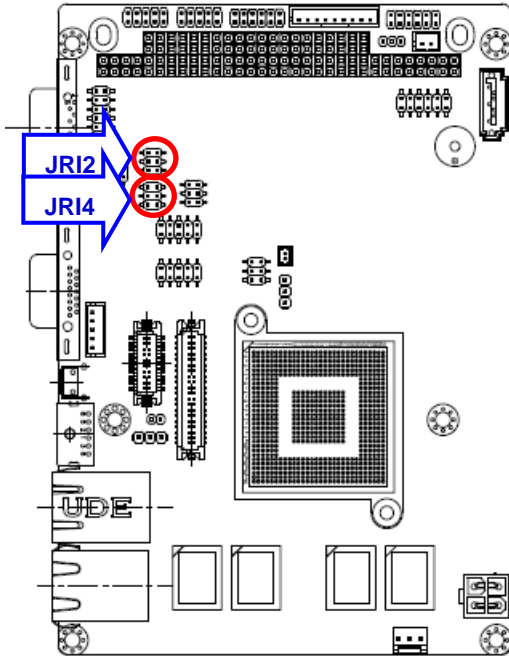

\* Default

## 2.3.6 COM 3 pin 9 signal select (JRI3)

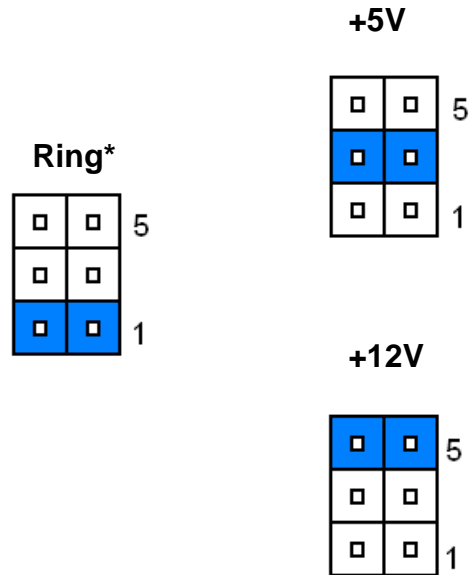
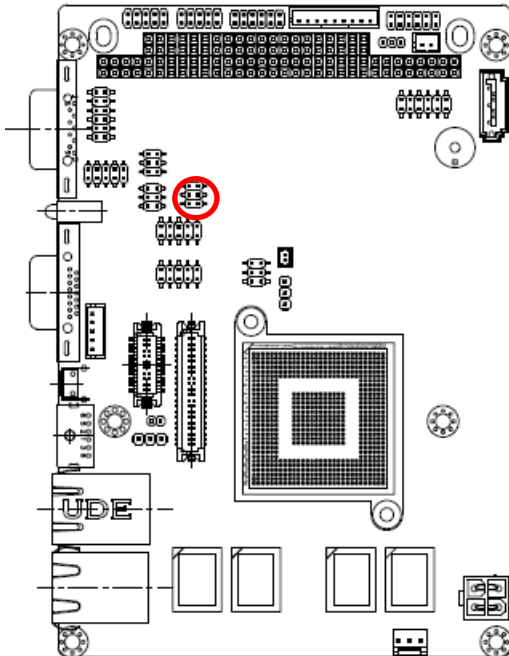

\* Default

# ECM-DX2 Quick Installation Guide

## 2.3.7 5VSB connector in ATX (PWR\_SB1)

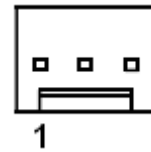
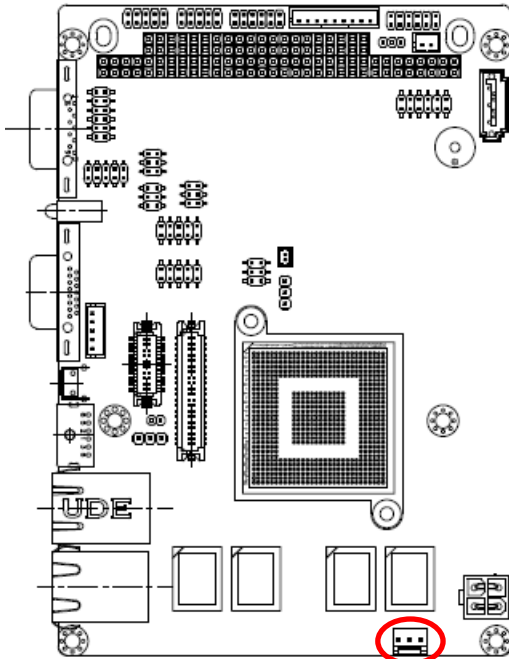

Signal	PIN
PS_ON#	1
NA	2
+5V	3

## 2.3.8 Battery connector (BT1)

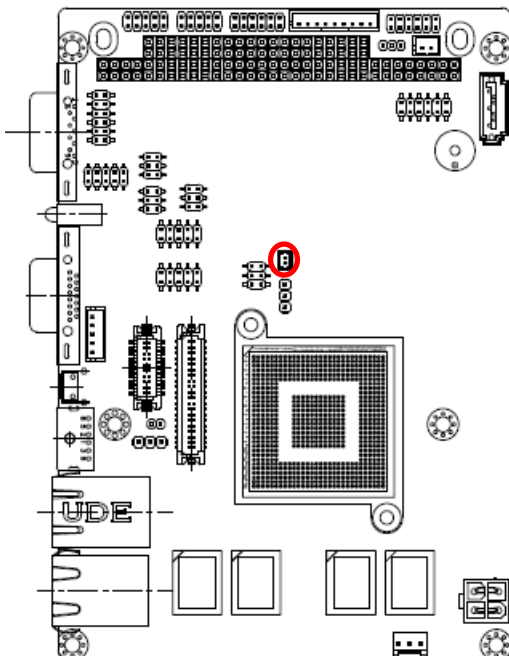

Signal	PIN
GND	2
+3.3V	1

# ECM-DX2 Quick Installation Guide

## 2.3.9 Power connector (PWR1)

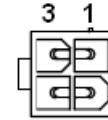
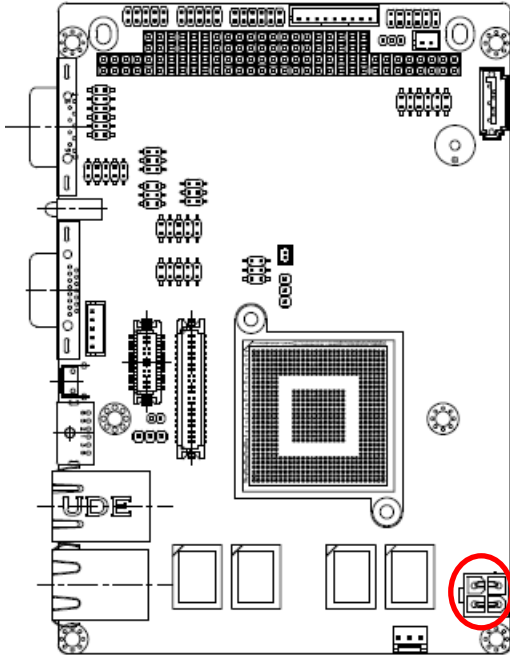

Signal	PIN	PIN	Signal
GND	1	2	GND
+12V	3	4	+12V

## 2.3.10 SATA Power connector (SPWR1)

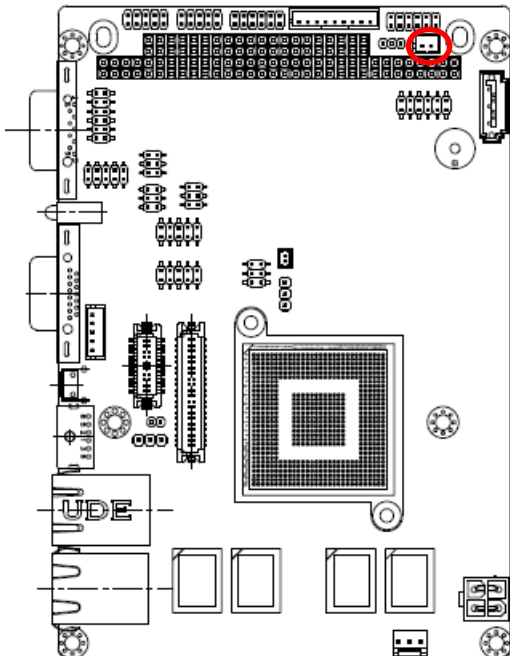

Signal	PIN
GND	1
+5V	2

# ECM-DX2 Quick Installation Guide

## 2.3.11 LCD inverter connector (BKL1)

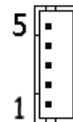
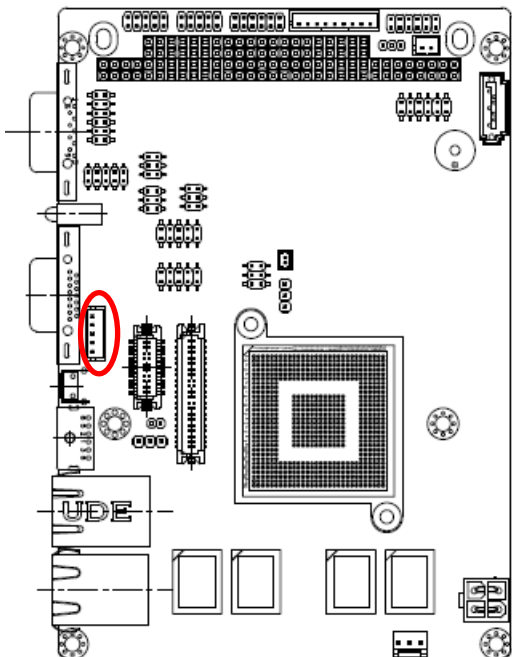

Signal	PIN
+5V	5
BRIGHT	4
TTL_ENBLT	3
GND	2
+12V	1

## 2.3.12 General purpose I/O connector (DIO1)

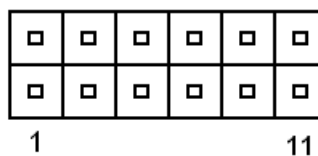
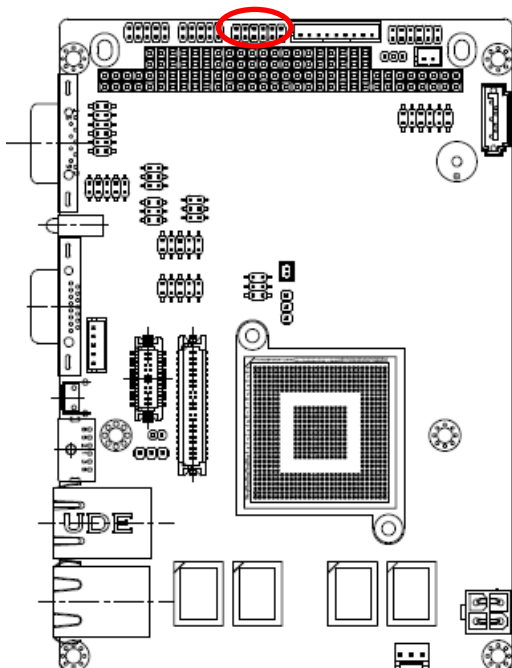

Signal	PIN	PIN	Signal
DIO0	1	2	DO_TTL0
DIO1	3	4	DO_TT1
DIO2	5	6	DO_TTL2
DIO3	7	8	DO_TTL3
I2C_CLK	9	10	I2C_DAT
GND	11	12	+5V

# ECM-DX2 Quick Installation Guide

## 2.3.13 Audio connector (AUD1)

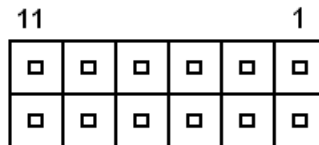
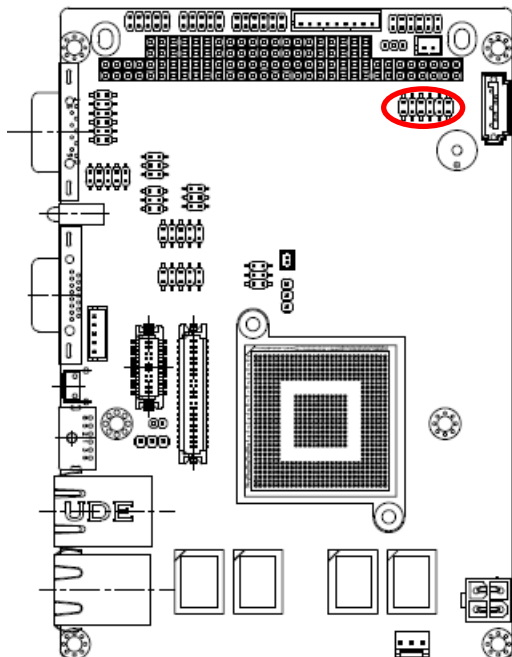

Signal	PIN	PIN	Signal
LINEOUT_R	1	2	LINEOUT_L
GND	3	4	GND
LINE1-RIN	5	6	LINE1-LIN
MIC-RIN	7	8	MIC-LIN
FRONT-JD	9	10	LINE1_JD
MIC1_JD	11	12	GND

### 2.3.13.1 Signal Description – Audio connector (AUD1)

Signal	Signal Description
LINE1_JD	AUDIO IN (LINE_RIN/LIN)sense pin
FRONT_JD	AUDIO Out(ROUT/LOUT) sense pin
MIC1_JD	MIC IN (MIC_RIN/LIN) sense pin

# ECM-DX2 Quick Installation Guide

## 2.3.14 Serial port 2/3/4 connector (COM2/3/4)

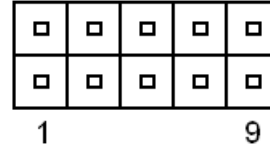
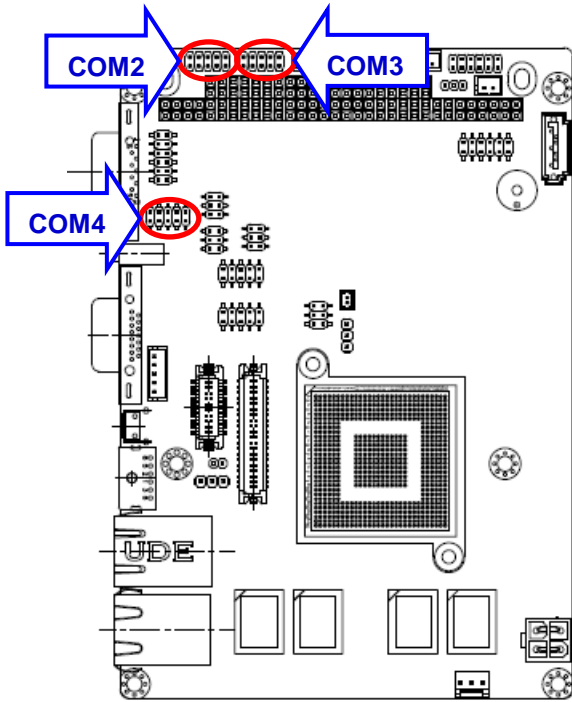

Signal	PIN	PIN	Signal
NDCD2/3/4#	1	2	NRX2/3/4#
NTX2/3/4#	3	4	NDTR2/3/4#
GND	5	6	NDSR2/3/4#
NRTS2/3/4#	7	8	NCTS2/3/4#
NR12/3/4#	9	10	NC

## 2.3.15 Touch connector (TOUCH1)

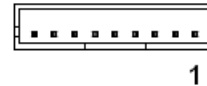
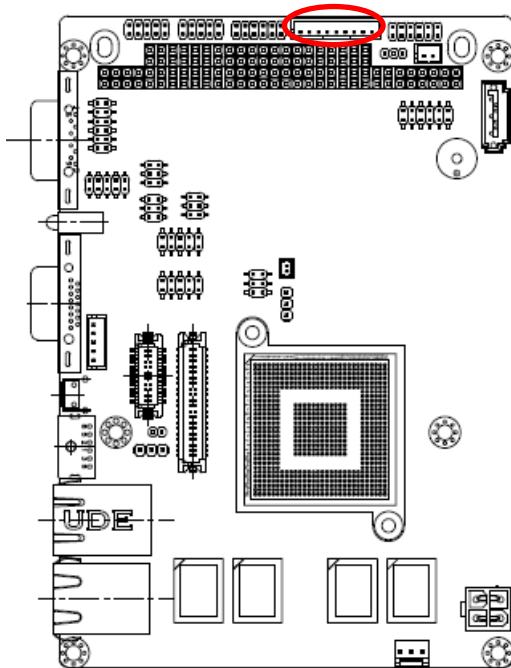

PIN	Signal	4-WIRE	5-WIRE	8-WIRE
1	X+	NC	NC	Right Sense
2	X-	NC	NC	Left Sense
3	Y+	NC	NC	Bottom Sense
4	SENSE	NC	Sense	Top Sense
5	X+	Right	LR	Right Excite
6	X-	Left	LL	Left Excite
7	Y+	Bottom	UR	Bottom Excite
8	Y-	Top	UL	Top Excite
9	GND	GND	GND	GND



# ECM-DX2 Quick Installation Guide

## 2.3.16 TFT panel connector (TTL1)

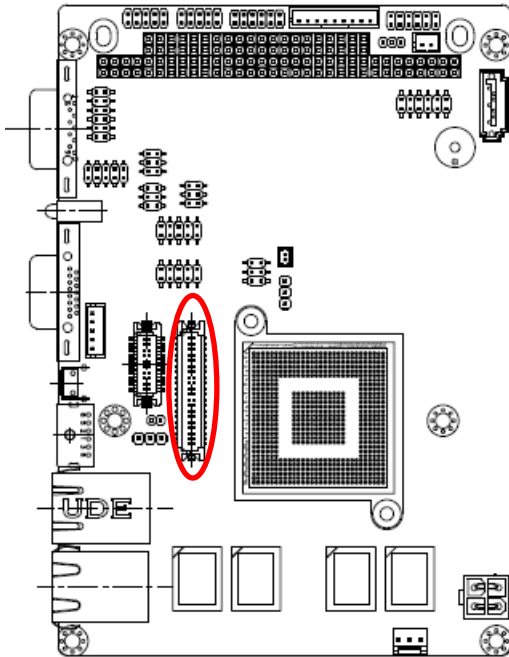

Signal	PIN	PIN	Signal
TTL_ENBLT	39	40	TTL_ENVEE
TTL_LVDE	37	38	TTL_LVHS
TTL_LVCLK	35	36	TTL_LVVS
GND	33	34	GND
TTL_R6	31	32	TTL_R7
TTL_R4	29	30	TTL_R5
TTL_R2	27	28	TTL_R3
TTL_R0	25	26	TTL_R1
TTL_G6	23	24	TTL_G7
TTL_G4	21	22	TTL_G5
TTL_G2	19	20	TTL_G3
TTL_G0	17	18	TTL_G1
TTL_B6	15	16	TTL_B7
TTL_B4	13	14	TTL_B5
TTL_B2	11	12	TTL_B3
TTL_B0	9	10	TTL_B1
NC	7	8	NC
+3V	5	6	+3V
GND	3	4	GND
+5V	1	2	+5V

# ECM-DX2 Quick Installation Guide

## 2.3.17 On-board pin header for USB2.0 (USB1)

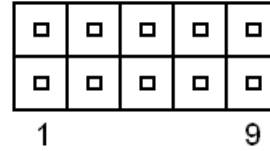
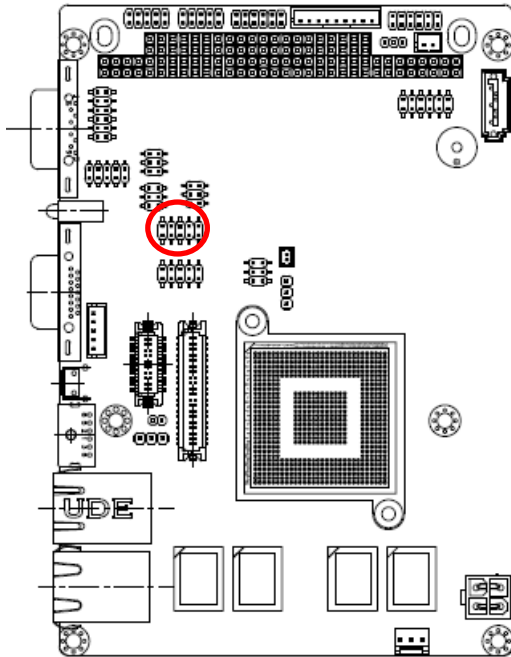

Signal	PIN	PIN	Signal
+5V	1	2	GND
USB0N	3	4	GND
USB0P	5	6	USB1P
GND	7	8	USB1N
GND	9	10	+5V

## 2.3.18 On-board pin header for USB2.0 (USB2)

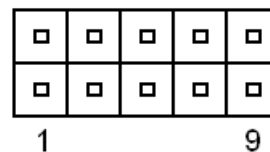
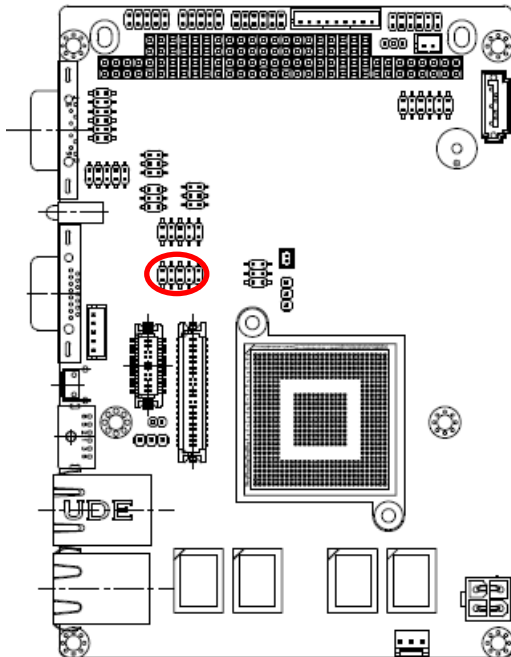

Signal	PIN	PIN	Signal
+5V	1	2	GND
USB2N	3	4	GND
USB2P	5	6	USB3P
GND	7	8	USB3N
GND	9	10	+5V

# ECM-DX2 Quick Installation Guide

## 2.3.19 Reserved for Debug (JTG1)

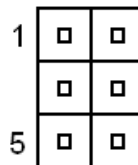
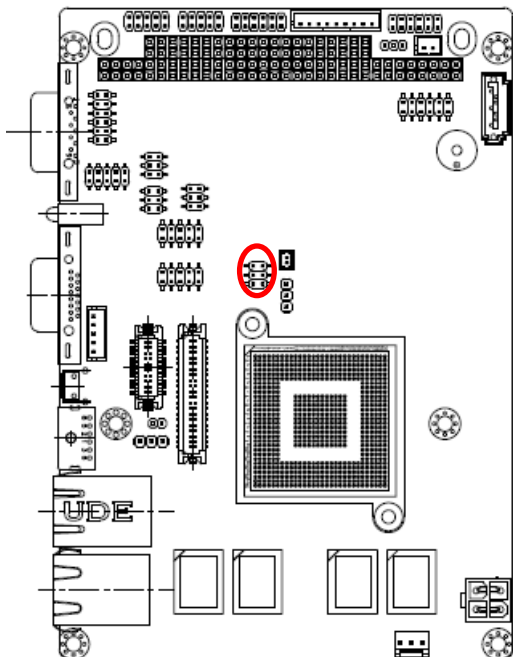

Signal	PIN	PIN	Signal
+5V	1	2	GND
TD0	3	4	TCK
TDI	5	6	TMS

## 2.3.20 LVDS connector (LVDS1)

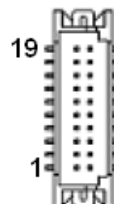
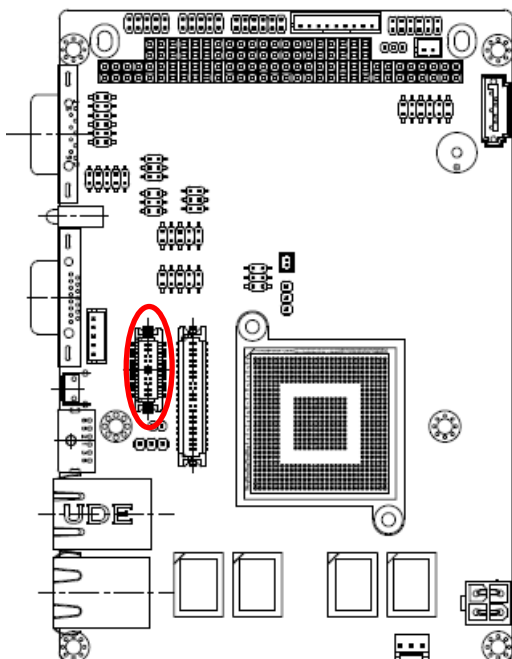

Signal	PIN	PIN	Signal
+3V	19	20	+5V
+3V	17	18	+5V
LVDS_DDC_DATA	15	16	LVDS_DDC_CLK
GND	13	14	GND
LVDS_CLKP	11	12	LVDS_CLKN
LVDS_TXD3P	9	10	LVDS_TXD3N
LVDS_TXD2P	7	8	LVDS_TXD2N
LVDS_TXD1P	5	6	LVDS_TXD1N
LVDS_TXD0P	3	4	LVDS_TXD0N
GND	1	2	GND

# ECM-DX2 Quick Installation Guide

## 2.3.21 LCD PWM Mode Selector (BPWM1)

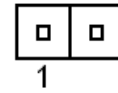
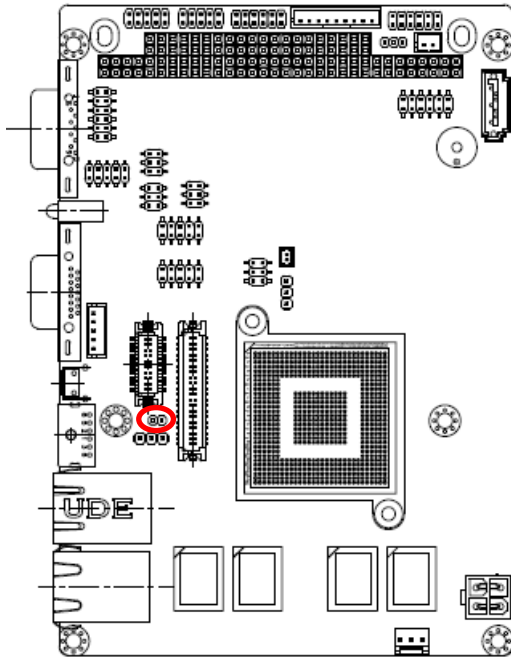

Signal	PIN
BRIGHT	1
PWM_D_BKLTCTRL	2

## 2.3.22 LCD backlight brightness adjustment connector (VR1)

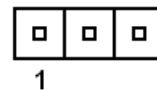
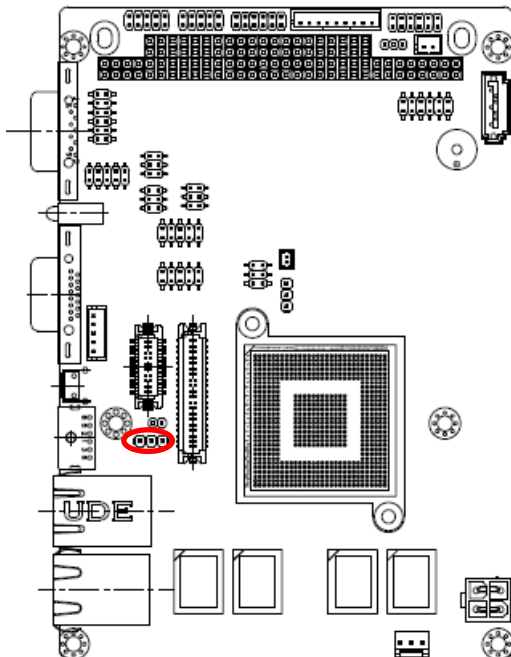

Signal	PIN
+5V	1
BRIGHT	2
GND	3

