

ECM-BYT2

Intel® Celeron®/Atom™ SoC Processors
3.5" Micro Module

User's manual

2nd Ed – 12 November 2014

FCC Statement



THIS DEVICE COMPLIES WITH PART 15 FCC RULES. OPERATION IS SUBJECT TO THE FOLLOWING TWO CONDITIONS:

(1) THIS DEVICE MAY NOT CAUSE HARMFUL INTERFERENCE.

(2) THIS DEVICE MUST ACCEPT ANY INTERFERENCE RECEIVED INCLUDING INTERFERENCE THAT MAY CAUSE UNDESIRE OPERATION.

THIS EQUIPMENT HAS BEEN TESTED AND FOUND TO COMPLY WITH THE LIMITS FOR A CLASS "A" DIGITAL DEVICE, PURSUANT TO PART 15 OF THE FCC RULES.

THESE LIMITS ARE DESIGNED TO PROVIDE REASONABLE PROTECTION AGAINST HARMFUL INTERFERENCE WHEN THE EQUIPMENT IS OPERATED IN A COMMERCIAL ENVIRONMENT. THIS EQUIPMENT GENERATES, USES, AND CAN RADIATE RADIO FREQUENCY ENERGY AND, IF NOT INSTALLED AND USED IN ACCORDANCE WITH THE INSTRUCTION MANUAL, MAY CAUSE HARMFUL INTERFERENCE TO RADIO COMMUNICATIONS.

OPERATION OF THIS EQUIPMENT IN A RESIDENTIAL AREA IS LIKELY TO CAUSE HARMFUL INTERFERENCE IN WHICH CASE THE USER WILL BE REQUIRED TO CORRECT THE INTERFERENCE AT HIS OWN EXPENSE.

Notice

This guide is designed for experienced users to setup the system within the shortest time. For detailed information, please always refer to the electronic user's manual.

Copyright Notice

Copyright © 2014 Avalue Technology Inc., ALL RIGHTS RESERVED.

No part of this document may be reproduced, copied, translated, or transmitted in any form or by any means, electronic or mechanical, for any purpose, without the prior written permission of the original manufacturer.

Trademark Acknowledgement

Brand and product names are trademarks or registered trademarks of their respective owners.

Disclaimer

Avalue Technology Inc. reserves the right to make changes, without notice, to any product, including circuits and/or software described or contained in this manual in order to improve design and/or performance. Avalue Technology assumes no responsibility or liability for the use of the described product(s), conveys no license or title under any patent, copyright, or masks work rights to these products, and makes no representations or warranties that these products are free from patent, copyright, or mask work right infringement, unless

2 ECM-BYT2 User's Manual

ECM-BYT2 User's Manual

otherwise specified. Applications that are described in this manual are for illustration purposes only. Avalue Technology Inc. makes no representation or warranty that such application will be suitable for the specified use without further testing or modification.

Life Support Policy

Avalue Technology's PRODUCTS ARE NOT FOR USE AS CRITICAL COMPONENTS IN LIFE SUPPORT DEVICES OR SYSTEMS WITHOUT THE PRIOR WRITTEN APPROVAL OF Avalue Technology Inc.

As used herein:

1. Life support devices or systems are devices or systems which, (a) are intended for surgical implant into body, or (b) support or sustain life and whose failure to perform, when properly used in accordance with instructions for use provided in the labeling, can be reasonably expected to result in significant injury to the user.
2. A critical component is any component of a life support device or system whose failure to perform can be reasonably expected to cause the failure of the life support device or system, or to affect its safety or effectiveness.

A Message to the Customer

Avalue Customer Services

Each and every Avalue's product is built to the most exacting specifications to ensure reliable performance in the harsh and demanding conditions typical of industrial environments. Whether your new Avalue device is destined for the laboratory or the factory floor, you can be assured that your product will provide the reliability and ease of operation for which the name Avalue has come to be known.

Your satisfaction is our primary concern. Here is a guide to Avalue's customer services. To ensure you get the full benefit of our services, please follow the instructions below carefully.

Technical Support

We want you to get the maximum performance from your products. So if you run into technical difficulties, we are here to help. For the most frequently asked questions, you can easily find answers in your product documentation. These answers are normally a lot more detailed than the ones we can give over the phone. So please consult the user's manual first.

To receive the latest version of the user's manual; please visit our Web site at:

<http://www.avalue.com.tw/>

ECM-BYT2 User's Manual

Product Warranty

Avalue warrants to you, the original purchaser, that each of its products will be free from defects in materials and workmanship for two years from the date of purchase.

This warranty does not apply to any products which have been repaired or altered by persons other than repair personnel authorized by Avalue, or which have been subject to misuse, abuse, accident or improper installation. Avalue assumes no liability under the terms of this warranty as a consequence of such events. Because of Avalue's high quality-control standards and rigorous testing, most of our customers never need to use our repair service. If any of Avalue's products is defective, it will be repaired or replaced at no charge during the warranty period. For out-of-warranty repairs, you will be billed according to the cost of replacement materials, service time, and freight. Please consult your dealer for more details. If you think you have a defective product, follow these steps:

1. Collect all the information about the problem encountered. (For example, CPU type and speed, Avalue's products model name, hardware & BIOS revision number, other hardware and software used, etc.) Note anything abnormal and list any on-screen messages you get when the problem occurs.
2. Call your dealer and describe the problem. Please have your manual, product, and any helpful information available.
3. If your product is diagnosed as defective, obtain an RMA (return material authorization) number from your dealer. This allows us to process your good return more quickly.
4. Carefully pack the defective product, a complete Repair and Replacement Order Card and a photocopy proof of purchase date (such as your sales receipt) in a shippable container. A product returned without proof of the purchase date is not eligible for warranty service.
5. Write the RMA number visibly on the outside of the package and ship it prepaid to your dealer.

CONTENT

1. Getting Started	8
1.1 Safety Precautions	8
1.2 Packing List	8
1.3 Document Amendment History.....	9
1.4 Manual Objectives.....	10
1.5 System Specifications	11
1.6 Architecture Overview – Block Diagram	13
2. Hardware Configuration	14
2.1 Product Overview	15
2.2 Installation Procedure.....	16
2.2.1 Main Memory	17
2.3 Jumper and Connector List	19
2.4 Setting Jumpers & Connectors.....	21
2.4.1 Clear CMOS (JBAT1).....	21
2.4.2 COM 1 pin 9 signal select (JRI1).....	21
2.4.3 AT/ATX power on type select (JAT1)	22
2.4.4 LCD backlight brightness adjustment (JBKL_SEL1)	22
2.4.5 Battery connector (BT1)	23
2.4.6 Low pin count connector (JLPC1)	23
2.4.7 CPU fan connector (CPU_FAN1).....	24
2.4.8 LCD inverter connector (JBKL1)	24
2.4.8.1 Signal Description – LCD Inverter Connector (JBKL1)	24
2.4.9 On-board header for USB2.0 (JUSB34)	25
2.4.10 On-board header for USB2.0 (JUSB56)	25
2.4.11 On-board header for USB2.0 (JUSB78)	26
2.4.12 Serial port 1 connector (COM1)	26
2.4.13 Serial port 2 connector (JCOM2).....	27
2.4.14 Serial port 1 in RS-422/485 mode (J422_485)	27
2.4.15 General purpose I/O connector (JDIO1).....	28
2.4.16 Miscellaneous setting connector (JFP1).....	28
2.4.17 BIOS SPI connector (BIOS_SPI1)	29
2.4.18 LCD backlight brightness adjustment (JBLK_CTRL1).....	29
2.4.19 EC Debug connector (JEC_ROM1).....	30
2.4.20 LVDS connector (JLVDS1).....	30
2.4.21 Power connector (PWR1).....	31

ECM-BYT2 User's Manual

2.4.22	SATA power connector (SATA_PWR1)	31
2.4.23	Audio connector (JAUDIO1)	32
2.4.23.1	Signal Description – Audio connector (JAUDIO1)	32
3. BIOS Setup		33
3.1	Introduction	34
3.2	Starting Setup	34
3.3	Using Setup	35
3.4	Getting Help	36
3.5	In Case of Problems	36
3.6	BIOS setup	37
3.6.1	Main Menu	37
3.6.1.1	System Language	37
3.6.1.2	System Date	37
3.6.1.3	System Time	37
3.6.2	Advanced Menu	38
3.6.2.1	ACPI Settings	38
3.6.2.2	IT8528 Super IO Configuration	39
3.6.2.2.1	Serial Port 1 Configuration	40
3.6.2.2.2	Serial Port 2 Configuration	41
3.6.2.3	H/W Monitor	41
3.6.2.4	S5 RTC Wake Settings	42
3.6.2.5	Serial Port Console Redirection	43
3.6.2.6	CPU Configuration	43
3.6.2.7	PPM Configuration	44
3.6.2.8	IDE Configuration	45
3.6.2.9	Network Stack Configuration	46
3.6.2.10	CSM Configuration	46
3.6.2.11	Trusted Computing	47
3.6.2.12	USB Configuration	48
3.6.2.13	Security Configuration	49
3.6.3	Chipset	50
3.6.3.1	North Bridge	50
3.6.3.1.1	Intel IGD Configuration	51
3.6.3.1.2	IGD - LCD Control	52
3.6.3.2	South Bridge	53
3.6.3.2.1	Azalia HD Audio	54
3.6.3.2.2	USB Configuration	54
3.6.3.2.3	PCI Express Configuration	55
3.6.4	Security	56
3.6.4.1	Secure Boot menu	56

ECM-BYT2 User's Manual

3.6.4.1.1	Key Management.....	57
3.6.5	Boot.....	58
3.6.6	Save and exit.....	59
3.6.6.1	Save Changes and Reset.....	59
3.6.6.2	Discard Changes and Reset.....	59
3.6.6.3	Restore Defaults.....	60
3.6.6.4	Launch EFI Shell from filesystem device.....	60
4.	Drivers Installation.....	61
4.1	Install Chipset Driver.....	62
4.2	Install MBI Driver.....	63
4.3	Install TXE Driver.....	64
4.4	Install VGA Driver.....	65
4.5	Install Audio Driver (For Realtek ALC892).....	66
4.6	Install Ethernet Driver (For Realtek RTL8111E).....	67
4.7	Install Hub Driver.....	68
5.	Mechanical Drawing.....	69

1. Getting Started

1.1 Safety Precautions

Warning!



Always completely disconnect the power cord from your chassis whenever you work with the hardware. Do not make connections while the power is on. Sensitive electronic components can be damaged by sudden power surges. Only experienced electronics personnel should open the PC chassis.

Caution!



Always ground yourself to remove any static charge before touching the CPU card. Modern electronic devices are very sensitive to static electric charges. As a safety precaution, use a grounding wrist strap at all times. Place all electronic components in a static-dissipative surface or static-shielded bag when they are not in the chassis.

1.2 Packing List

Before you begin installing your single board, please make sure that the following materials have been shipped:

- 1 x 3.5" ECM-BYT2 Micro Module
- 1 x DVD-ROM contains the followings:
 - User's Manual (this manual in PDF file)
 - Ethernet driver and utilities
 - VGA drivers and utilities
 - Audio drivers and utilities
- 1 x Cable set contains the followings:
 - 1 x Serial ATA cable (7-pin, standard)
 - 1 x Wire SATA power cable (15-pin, 2P/2.0mm)
 - 1 x Flat cable 9P(M)-PHD 10P/2.0mm)
- 3M foam (VHB-4622 10mm*20mm*1.1mm)

1.3 Document Amendment History

Revision	Date	Comment
1 st	August 2014	Initial Release
2 nd	November 2014	Remove PWR_SB1 connector

1.4 Manual Objectives

This manual describes in detail the Avalue Technology ECM-BYT2 Single Board.

We have tried to include as much information as possible but we have not duplicated information that is provided in the standard IBM Technical References, unless it proved to be necessary to aid in the understanding of this board.

We strongly recommend that you study this manual carefully before attempting to interface with ECM-BYT2 series or change the standard configurations. Whilst all the necessary information is available in this manual we would recommend that unless you are confident, you contact your supplier for guidance.

Please be aware that it is possible to create configurations within the CMOS RAM that make booting impossible. If this should happen, clear the CMOS settings, (see the description of the Jumper Settings for details).

If you have any suggestions or find any errors concerning this manual and want to inform us of these, please contact our Customer Service department with the relevant details.

1.5 System Specifications

System	
CPU	Intel® Celeron® Processor J1900 Family Intel® Atom™ Processor E3800 Family CPU mount in Solder side
BIOS	AMI uEFI BIOS, 64Mbit SPI Flash ROM
System Chipset	Valleyview SoC integrated
I/O Chip	EC(IT8528E)
System Memory	1 x 204-pin DDR3L 1066/1333 SODIMM up to 8G
Watchdog Timer	H/W Reset, 1sec. – 65535 sec.
H/W Status Monitor	CPU & system temperature monitoring Voltages monitoring
Expansion	2 x mini-PCIe 1 x Full-Size Mini PCI Express Mini Card with mSATA supported 1 x Half-Size Mini PCI Express Mini Card
I/O	
MIO	1 x SATA II COM1 supports RS232/422/485 COM2 -1 x RS232 (Pin header)
USB	1 x USB3.0, 7 x USB 2.0
GPIO	4-bit GPI, 4-bit GPO
Display	
Chipset	Valleyview SoC integrated Graphics
Resolution	VGA Mode: 2560 x 1080@60Hz HDMI mode: 1920 x 1200@60Hz LVDS mode: 1920 x 1080@60Hz
Multiple Display	HDMI + LVDS CRT + LVDS CRT + HDMI
HDMI	HDMI x 1
LCD Interface	Dual channel 18/24-bit LVDS
Audio	
AC97 Codec	Realtek ALC892 Supports 5.1-CH Audio
Ethernet	
LAN Chip	2 x Realtek RTL 8111E
Ethernet Interface	10/100/1000 Base-Tx compatible

ECM-BYT2 User's Manual

Mechanical & Environmental	
Power Requirement	+12V ~ +26V
ACPI	Single power ATX Support S0, S3, S4, S5 ACPI 3.0 Compliant
Power Type	AT / ATX
Operating Temp.	0°C ~ 60°C
Storage Temp.	-40°C ~75°C
Operating Humidity	0% ~ 90% relative humidity, non-condensing
Size (L x W)	5.7" x 4" (146mm x 101mm)
Weight	0.41 lbs (0.18 Kg)

1.6 Architecture Overview – Block Diagram

The following block diagram shows the architecture and main components of ECM-BYT2.

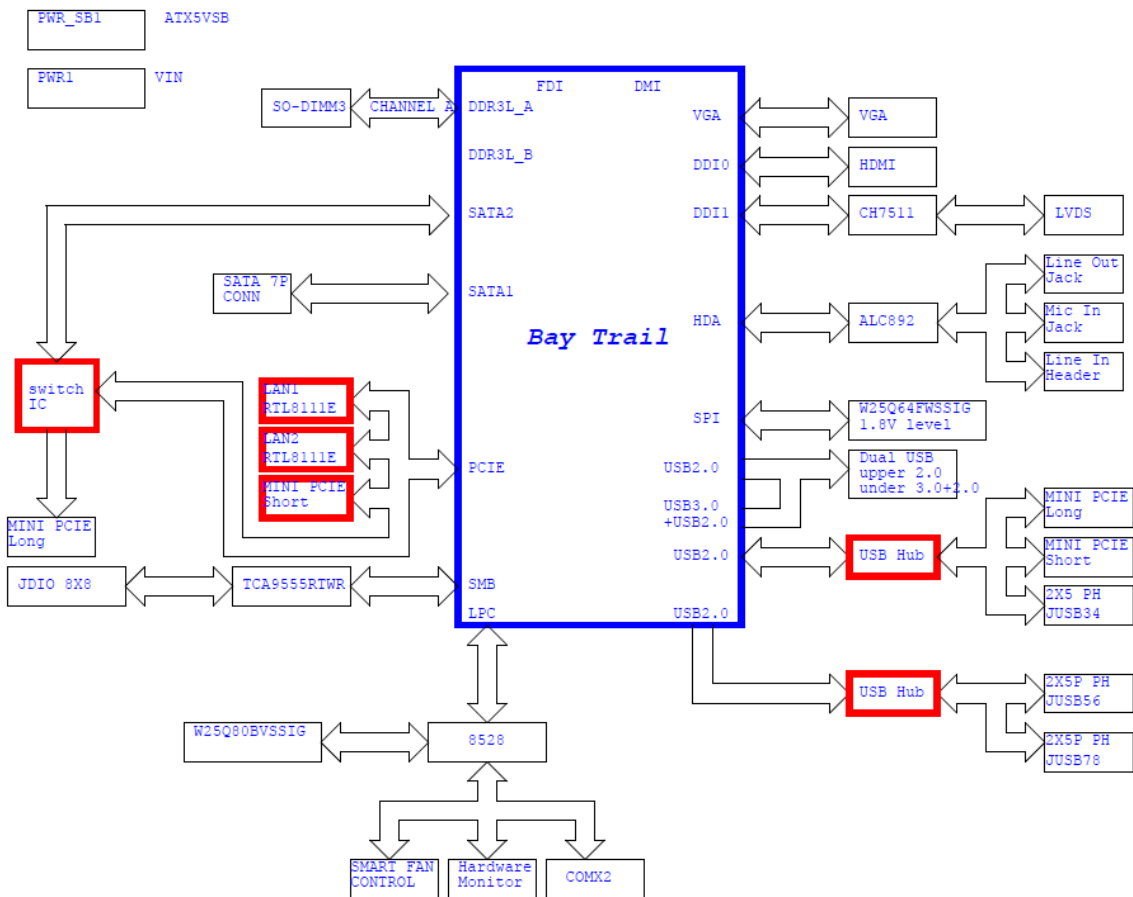

2. Hardware Configuration

2.1 Product Overview

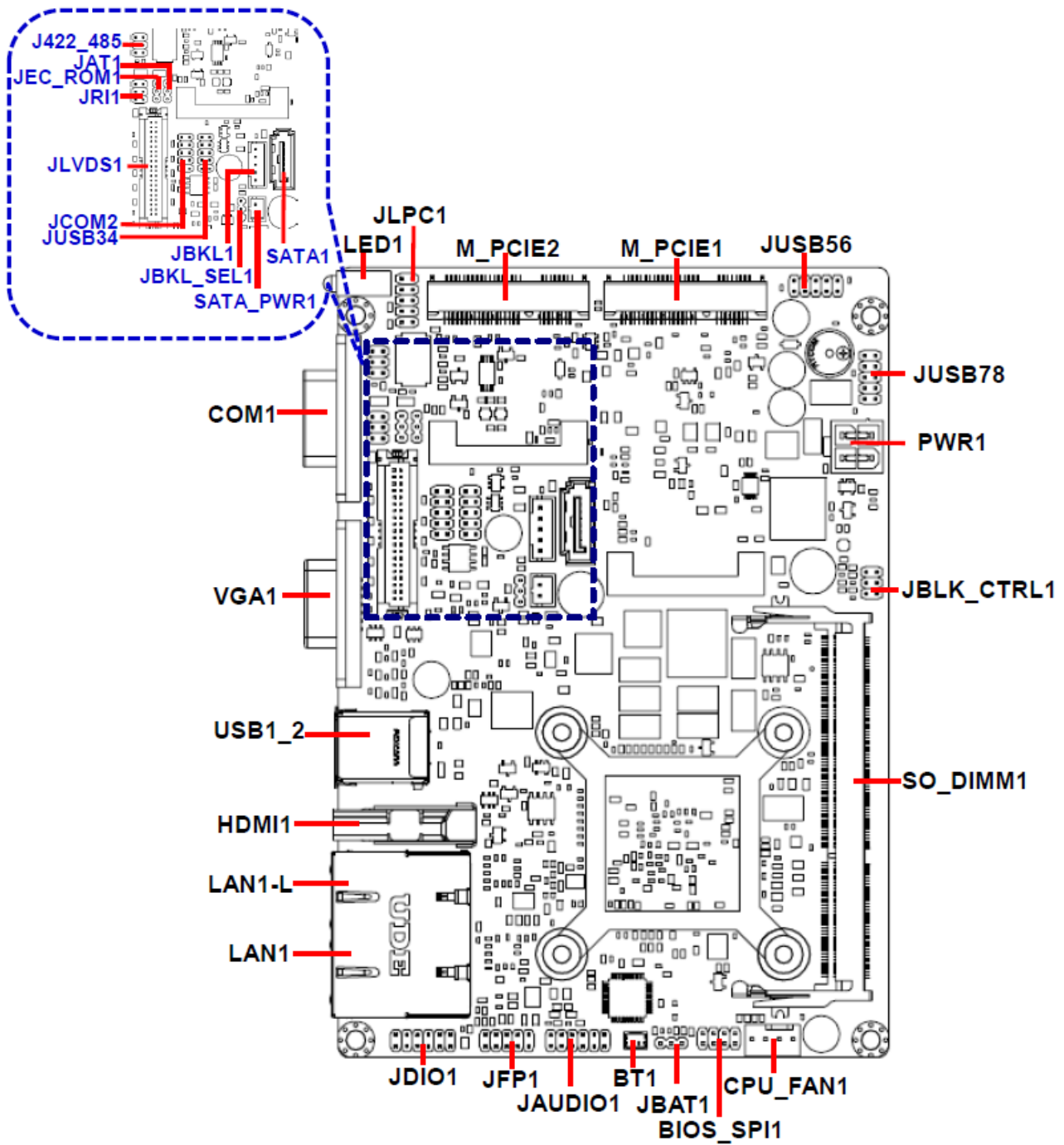

2.2 Installation Procedure

This chapter explains you the instructions of how to setup your system.

1. Turn off the power supply.
2. Insert the SODIMM module (be careful with the orientation).
3. Insert all external cables for hard disk, floppy, keyboard, mouse, USB etc. except for flat panel. A CRT monitor must be connected in order to change CMOS settings to support flat panel.
4. Connect power supply to the board via the ATXPWR.
5. Turn on the power.
6. Enter the BIOS setup by pressing the delete key during boot up. Use the "LOAD BIOS DEFAULTS" feature. The **Integrated Peripheral Setup** and the **Standard CMOS Setup** Window must be entered and configured correctly to match the particular system configuration.
7. If TFT panel display is to be utilized, make sure the panel voltage is correctly set before connecting the display cable and turning on the power.



Note: Make sure the heat sink and the CPU top surface are in total contact to avoid CPU overheating problem that would cause the system to hang or unstable

2.2.1 Main Memory

ECM-BYT2 provides one 204-pin DDR3L SODIMM socket, supports up to 8GB DDR3L 1066/1333 SDRAM.

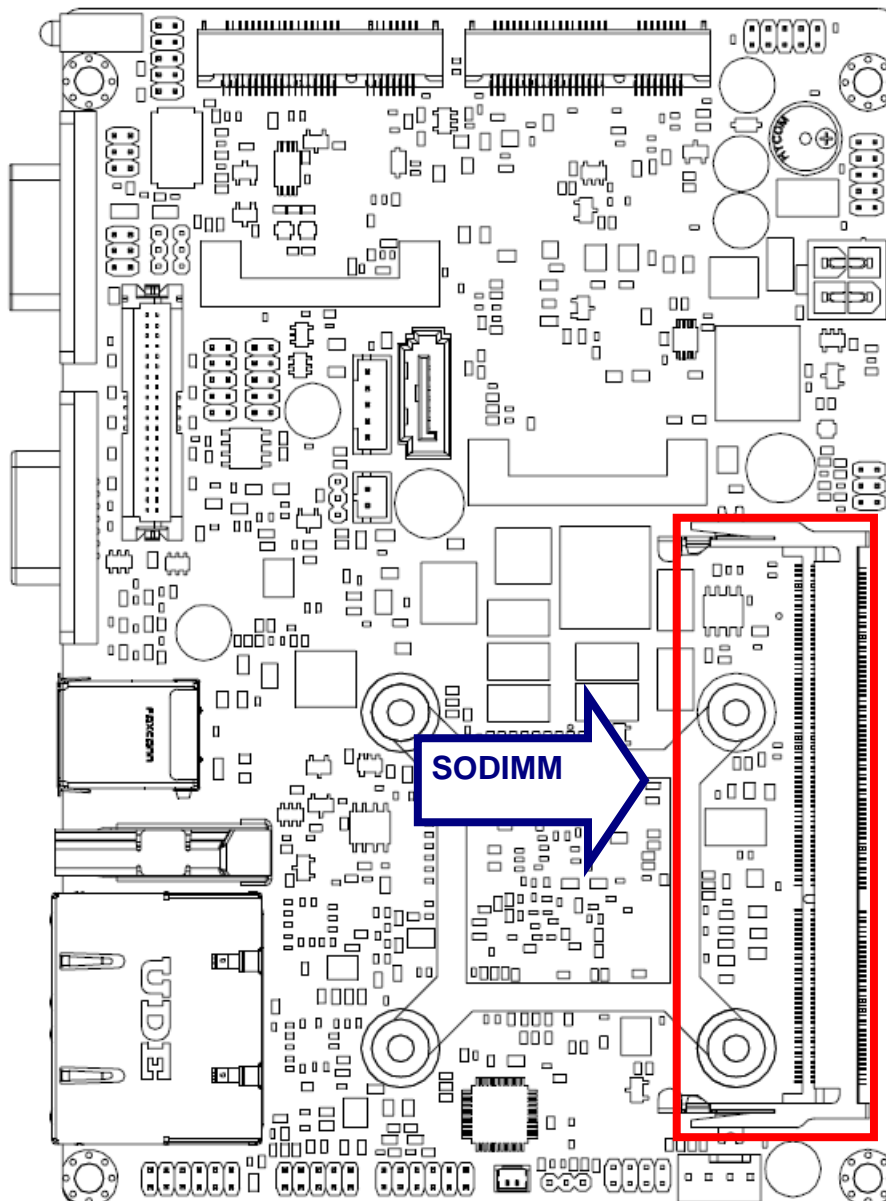

Make sure to unplug the power supply before adding or removing SODIMMs or other system components. Failure to do so may cause severe damage to both the board and the components.

- Locate the SODIMM socket on the board.
- Hold two edges of the SODIMM module carefully. Keep away of touching its connectors.
- Align the notch key on the module with the rib on the slot.

ECM-BYT2 User's Manual

- Firmly press the modules into the socket automatically snaps into the mounting notch. Do not force the SODIMM module in with extra force as the SODIMM module only fit in one direction.

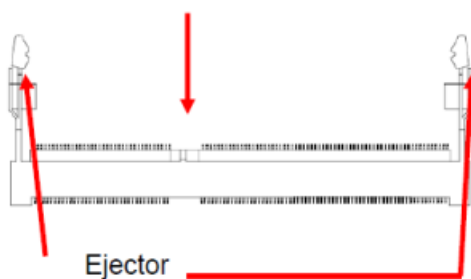
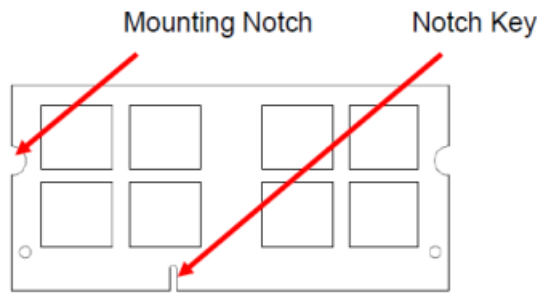

204-pin DDR3L SODIMM

- To remove the SODIMM modules, push the two ejector tabs on the slot outward simultaneously, and then pull out the SODIMM module.



Note:

- (1) Please do not change any DDR3L SDRAM parameter in BIOS setup to increase your system's performance without acquiring technical information in advance.
- (2) Static electricity can damage the electronic components of the computer or optional boards. Before starting these procedures, ensure that you are discharged of static electricity by touching a grounded metal object briefly.

2.3 Jumper and Connector List

You can configure your board to match the needs of your application by setting jumpers. A jumper is the simplest kind of electric switch.

It consists of two metal pins and a small metal clip (often protected by a plastic cover) that slides over the pins to connect them. To “close” a jumper you connect the pins with the clip. To “open” a jumper you remove the clip. Sometimes a jumper will have three pins, labeled 1, 2, and 3. In this case, you would connect either two pins.

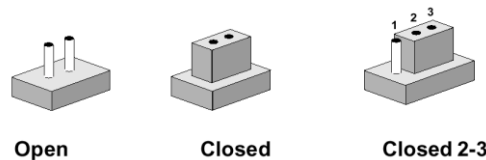

The jumper settings are schematically depicted in this manual as follows:



A pair of needle-nose pliers may be helpful when working with jumpers.

Connectors on the board are linked to external devices such as hard disk drives, a keyboard, or floppy drives. In addition, the board has a number of jumpers that allow you to configure your system to suit your application.

If you have any doubts about the best hardware configuration for your application, contact your local distributor or sales representative before you make any changes.

The following tables list the function of each of the board's jumpers and connectors.

Jumpers

Label	Function	Note
JBAT1	Clear CMOS	3 x 1 header, pitch 2.00 mm
JRI1	COM 1 pin 9 signal select	3 x 2 header, pitch 2.00 mm
JAT1	AT/ATX power on type select	3 x 1 header, pitch 2.00 mm
JBKL_SEL1	LCD backlight brightness select	3 x 1 header, pitch 2.00 mm

Connectors

Label	Function	Note
BT1	Battery connector	2 x 1 wafer, pitch 1.25 mm
CPU_FAN1	CPU fan connector	4 x 1 wafer, pitch 2.54 mm
HDMI1	HDMI connector	
JAUDIO1	Audio connector	6 x 2 header, pitch 2.00 mm

ECM-BYT2 User's Manual

JBKL1	LCD inverter connector	5 x 1 wafer, pitch 2.00 mm
JBLK_CTRL1	LCD backlight brightness adjustment	3 x 2 header, pitch 2.00 mm
COM1	Serial port 1 connector	D-sub 9-pin, male Note : COM1 support RS422/485 by BIOS setting
JCOM2	Serial port 2 connector	5 x 2 header, pitch 2.00 mm
J422_485	Serial port 1 in RS-422/485 mode	3 x 2 header, pitch 2.00 mm
JDIO1	General purpose I/O connector	6 x 2 header, pitch 2.00 mm
JFP1	Miscellaneous setting connector	5 x 2 header, pitch 2.00 mm
JLPC1	Low pin count interface	5 x 2 header, pitch 2.00 mm
JLVDS1	LVDS connector	DIN 40-pin wafer, pitch 1.25mm
USB1_2	On-board connector for USB2.0 x 1 On-board connector for USB3.0 x 1	
JUSB34	On-board header for USB2.0	5 x 2 header, pitch 2.00 mm
JUSB56	On-board header for USB2.0	5 x 2 header, pitch 2.00 mm
JUSB78	On-board header for USB2.0	5 x 2 header, pitch 2.00 mm
JEC_ROM1	EC Debug connector	3 x 1 header, pitch 2.00 mm
LAN1	RJ-45 Ethernet connector	
LAN1-L	RJ-45 Ethernet connector	
LED1	LED connector	
PWR1	Power connector	2 x 2 wafer, pitch 4.20 mm
SATA_PWR1	SATA power connector	2 x 1 wafer, pitch 2.00 mm
SATA1	Serial ATA connector 1	
VGA1	VGA connector	D-sub 15-pin, female
BIOS_SPI1	BIOS SPI connector	4 x 2 header, pitch 2.00 mm
M_PCIE1/2	Mini-PCI connector 1/2	
SO_DIMM1	DDR3L SODIMM connector	

2.4 Setting Jumpers & Connectors

2.4.1 Clear CMOS (JBAT1)

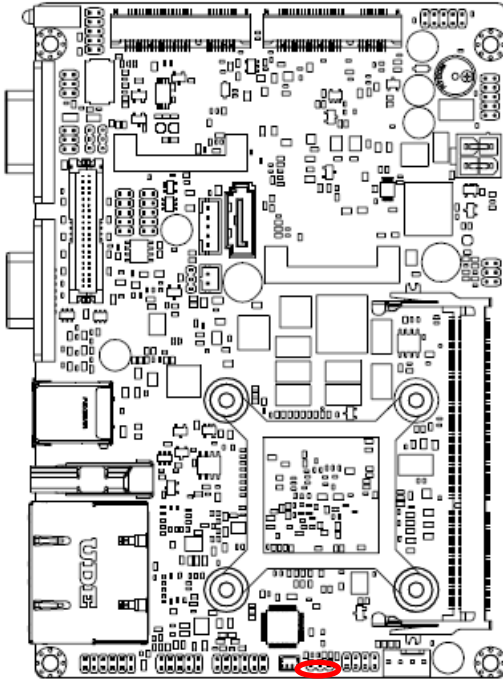

Protect*

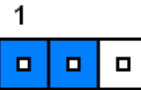

Clear CMOS

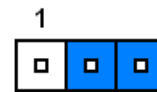

* Default

2.4.2 COM 1 pin 9 signal select (JR1)

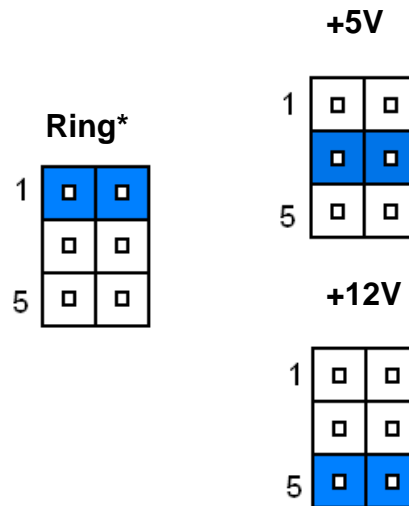
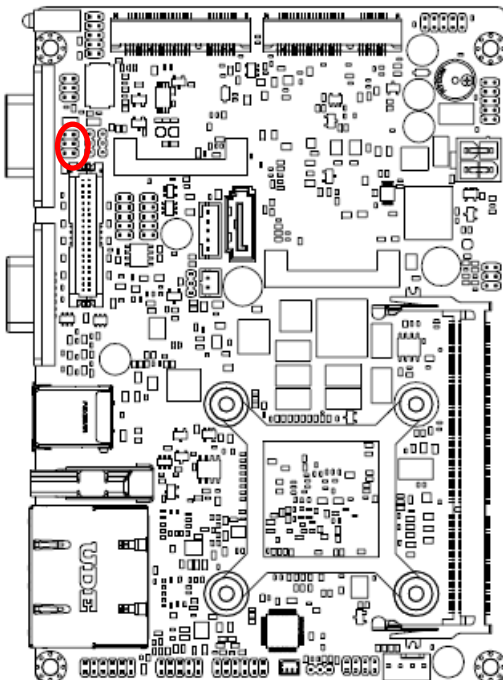

* Default

2.4.3 AT/ATX power on type select (JAT1)

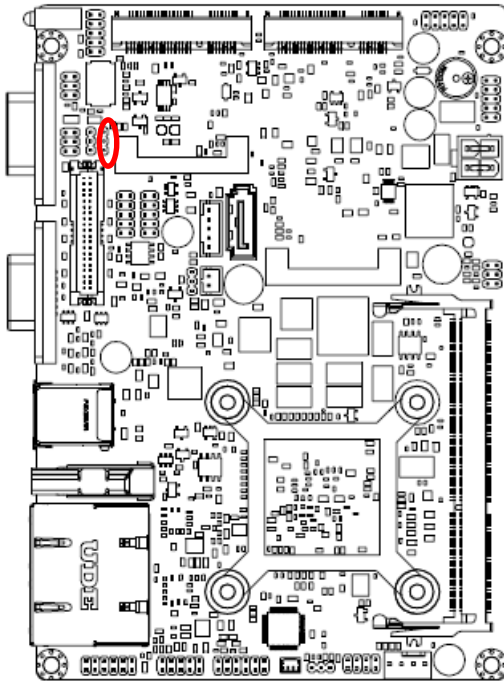

AT*

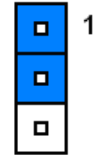

ATX

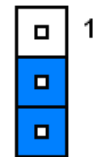

* Default

2.4.4 LCD backlight brightness adjustment (JBKL_SEL1)

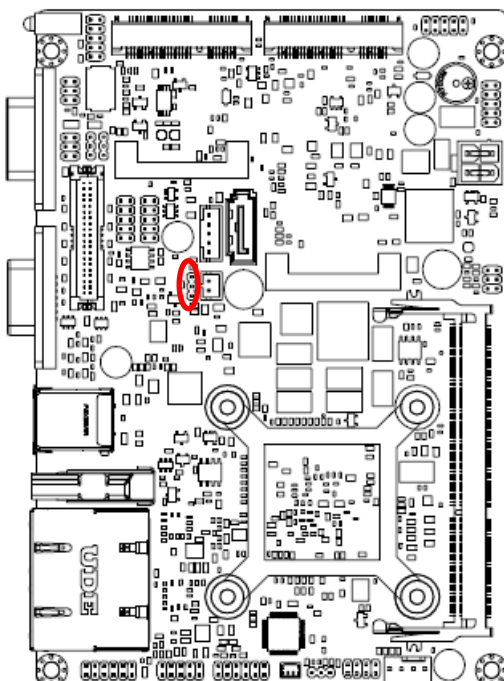

PWM Mode*

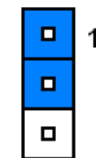

DC Mode

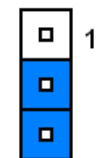

* Default

2.4.5 Battery connector (BT1)

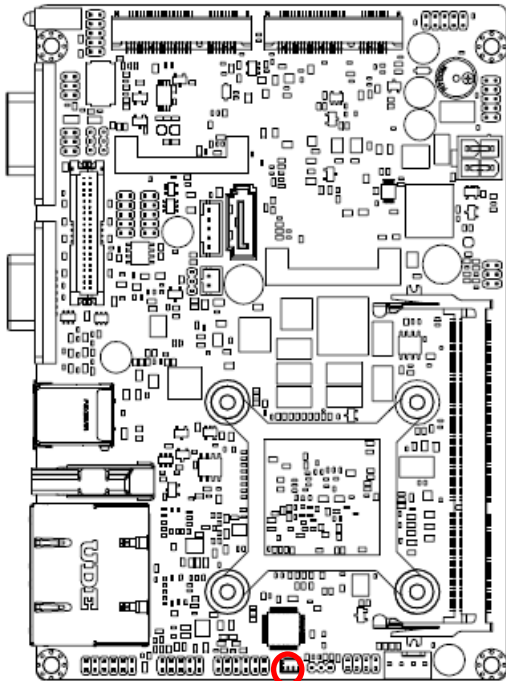

Signal	PIN
+3.3VSB	1
GND	2

2.4.6 Low pin count connector (JLPC1)

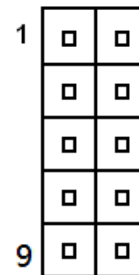
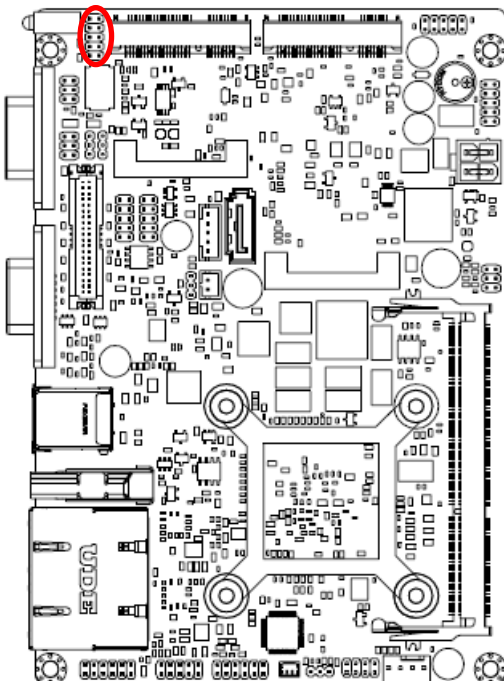

Signal	PIN	PIN	Signal
LPC_AD0	1	2	+3.3V
LPC_AD1	3	4	LPC_PORT80_RST#
LPC_AD2	5	6	LPC_FRAME#
LPC_AD3	7	8	LPC_PORT80_CLK
LPC_SERIRQ	9	10	GND

ECM-BYT2 User's Manual

2.4.7 CPU fan connector (CPU_FAN1)

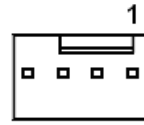
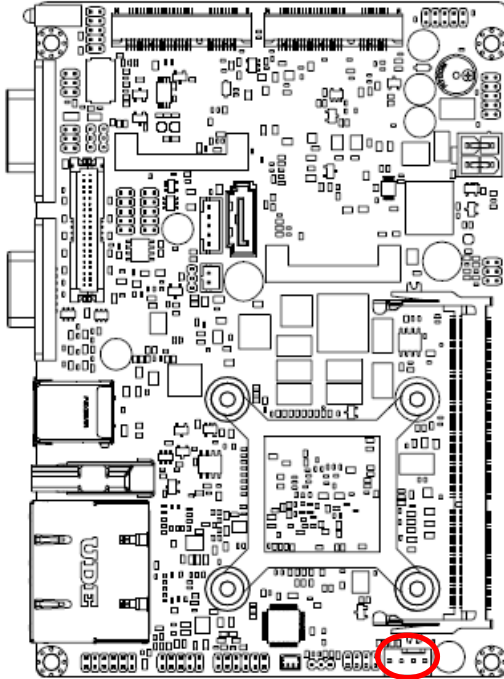

Signal	PIN
GND	1
+12V	2
EC_TACH0	3
FAN_PWM0	4

2.4.8 LCD inverter connector (JBKL1)

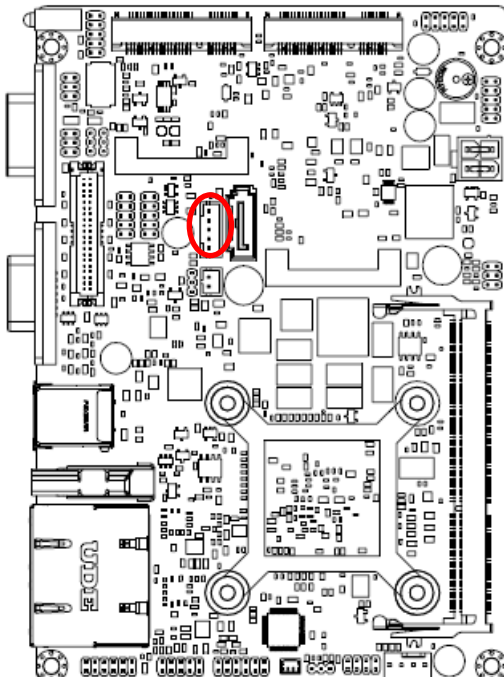

Signal	PIN
+5V	5
VBRIGHT	4
BKLEN	3
GND	2
+12V	1

2.4.8.1 Signal Description – LCD Inverter Connector (JBKL1)

Signal	Signal Description
VBRIGHT	$V_{adj} = 0.75V \sim 4.25V$ (Recommended: $4.7K\Omega$, $>1/16W$)
BKLEN	LCD backlight ON/OFF control signal

2.4.9 On-board header for USB2.0 (JUSB34)

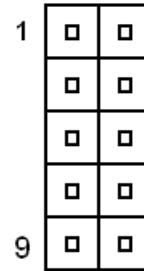
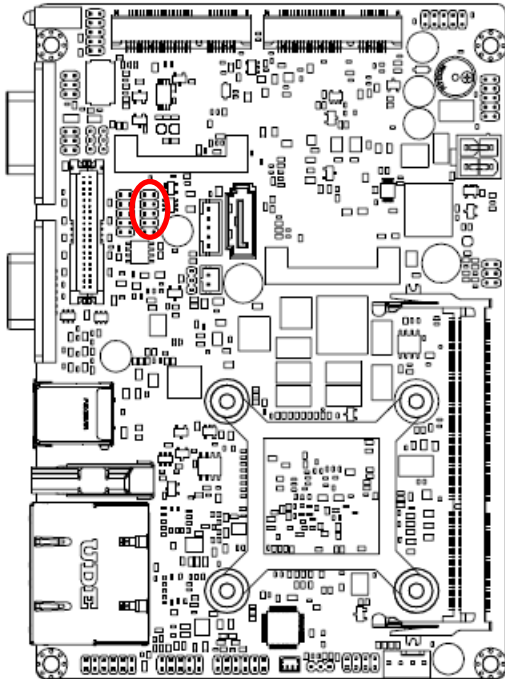

Signal	PIN	PIN	Signal
USBVCC3	1	2	GND
USB_DN_R_3	3	4	GND
USB_DP_R_3	5	6	USB_Touch_R_DP
GND	7	8	USB_Touch_R_DN
GND	9	10	USBVCC3

2.4.10 On-board header for USB2.0 (JUSB56)

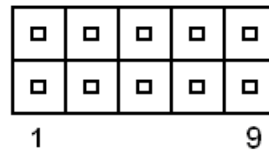
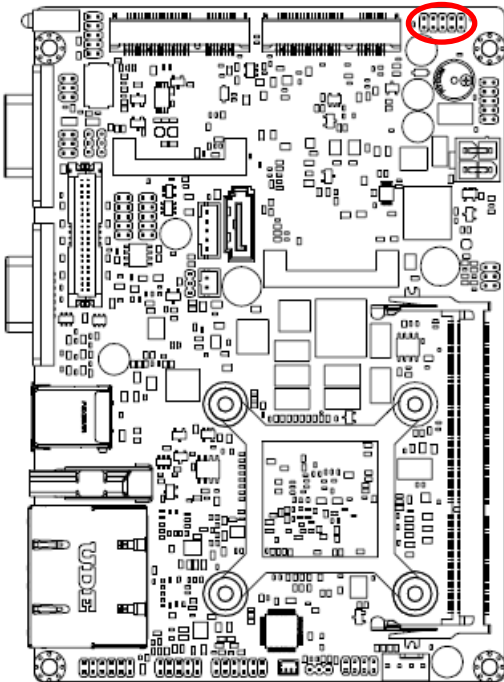

Signal	PIN	PIN	Signal
USBVCC4	1	2	GND
USB_HUB2_DN_R_1	3	4	GND
USB_HUB2_DP_R_1	5	6	USB_HUB2_DP_R_2
GND	7	8	USB_HUB2_DN_R_2
GND	9	10	USBVCC4

ECM-BYT2 User's Manual

2.4.11 On-board header for USB2.0 (JUSB78)

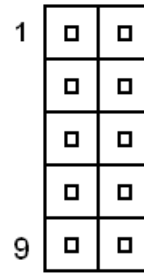
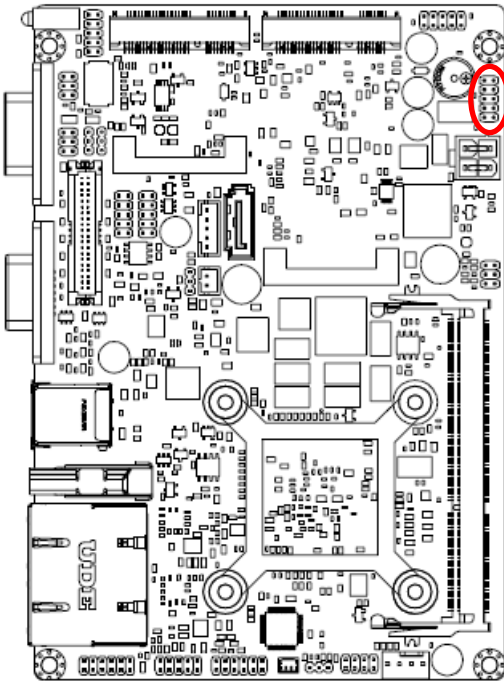

Signal	PIN	PIN	Signal
USBVCC5	1	2	GND
USB_HUB2_DN_R_3	3	4	GND
USB_HUB2_DP_R_3	5	6	USB_HUB2_DP_R_4
GND	7	8	USB_HUB2_DN_R_4
GND	9	10	USBVCC5

2.4.12 Serial port 1 connector (COM1)

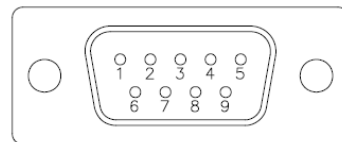
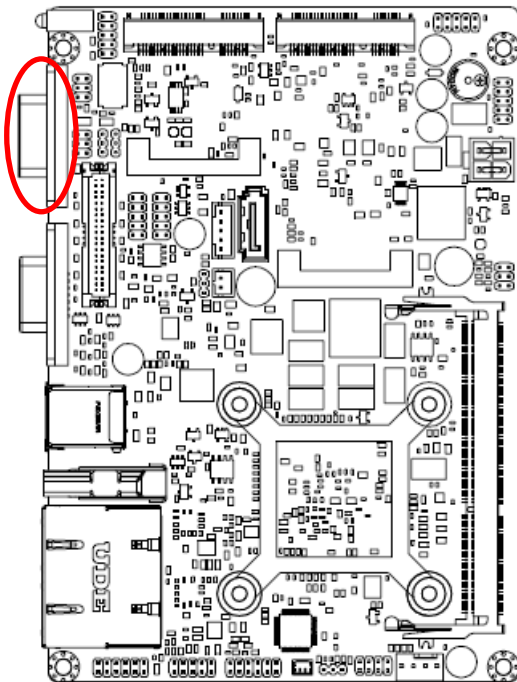

Signal	PIN	PIN	Signal
NDCDA#	1	6	NDSRA#
NRXDA	2	7	RTSA#
NTXDA	3	8	NCTSA#
NDTRA#	4	9	NRIA#
GND	5		

ECM-BYT2 User's Manual

2.4.13 Serial port 2 connector (JCOM2)

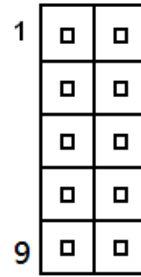
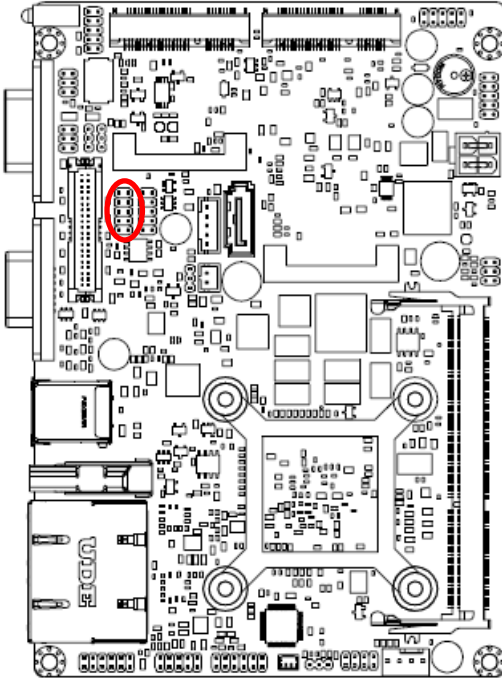

Signal	PIN	PIN	Signal
NDCDB#	1	2	NRXDB
NTXDB	3	4	NDTRB#
GND	5	6	NDSRB#
NRTSB#	7	8	NCTSB#
NRIB#	9	10	NC

2.4.14 Serial port 1 in RS-422/485 mode (J422_485)

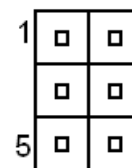
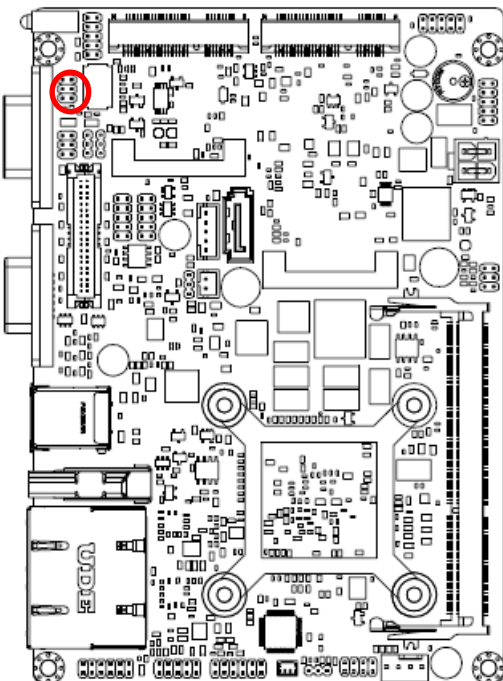

Signal	PIN	PIN	Signal
485TX2-	1	2	485RX2-
485TX2+	3	4	485RX2+
+5V	5	6	GND

ECM-BYT2 User's Manual

2.4.15 General purpose I/O connector (JDIO1)

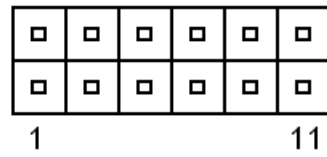
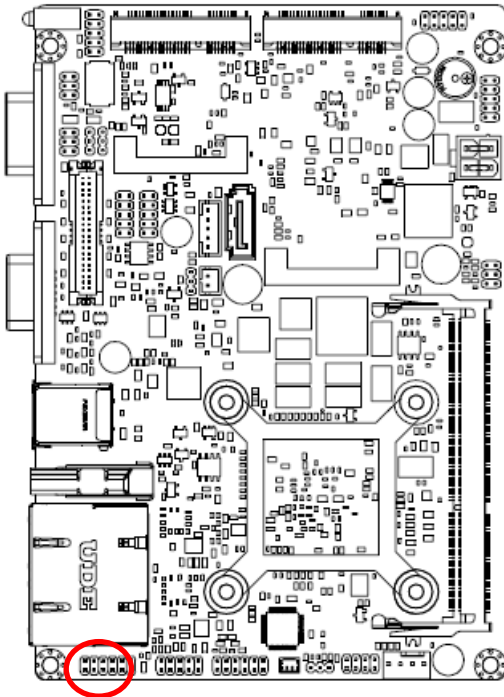

Signal	PIN	PIN	Signal
DIO_GP20	1	2	DIO_GP10
DIO_GP21	3	4	DIO_GP11
DIO_GP22	5	6	DIO_GP12
DIO_GP23	7	8	DIO_GP13
SMB_CLK_9555	9	10	SMB_DATA_9555
GND	11	12	+5V

2.4.16 Miscellaneous setting connector (JFP1)

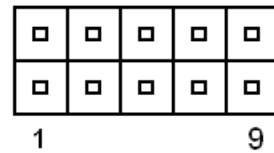
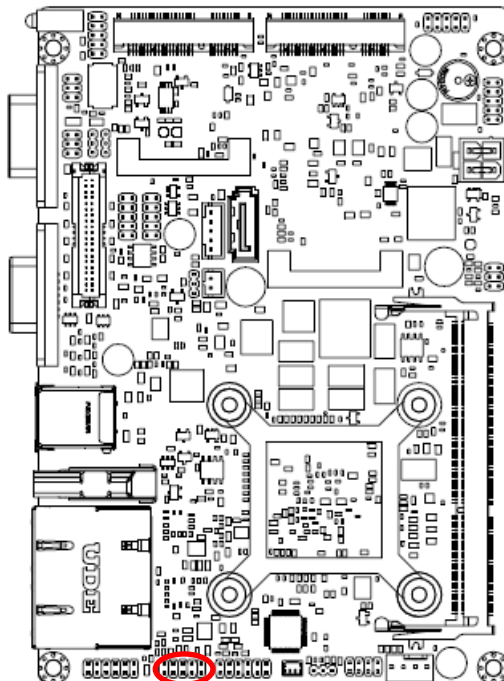

Signal	PIN
PWBT	1
	2
RST#	3
	4
PWR-LED+	5
PWR-LED-	6
HDD-LED-	7
HDD-LED+	8
CASE_OPEN#	9
	10

2.4.17 BIOS SPI connector (BIOS_SPI1)

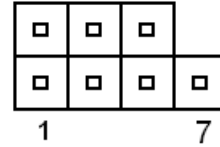
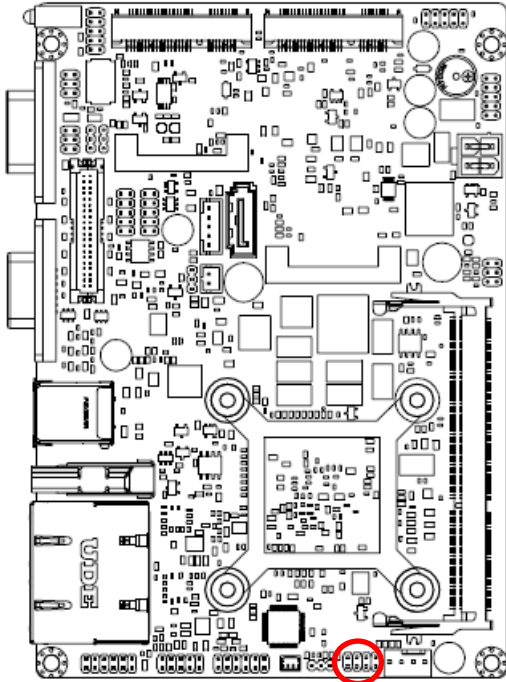

Signal	PIN	PIN	Signal
+VSPI_BIOS	1	2	GND
SPI_ROM_CS#	3	4	SPI_ROM_CLK
SPI_ROM_MISO_R	5	6	SPI_ROM_MOSI
SPI_HOLD#	7		

2.4.18 LCD backlight brightness adjustment (JBLK_CTRL1)

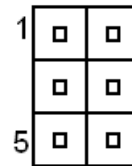
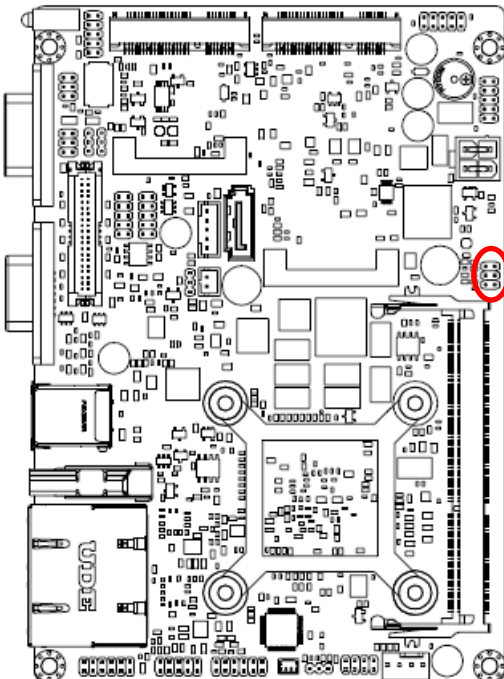

PIN	Signal	Note
1-2	BLK_VR_MOD	VR must select 10K/1%
3-4	BLK_BRI_UP	Low pulse button for backlight brighter
5-6	BLK_BRI_DN	Low pulse button for backlight dim

2.4.19 EC Debug connector (JEC_ROM1)

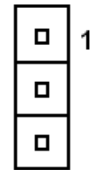
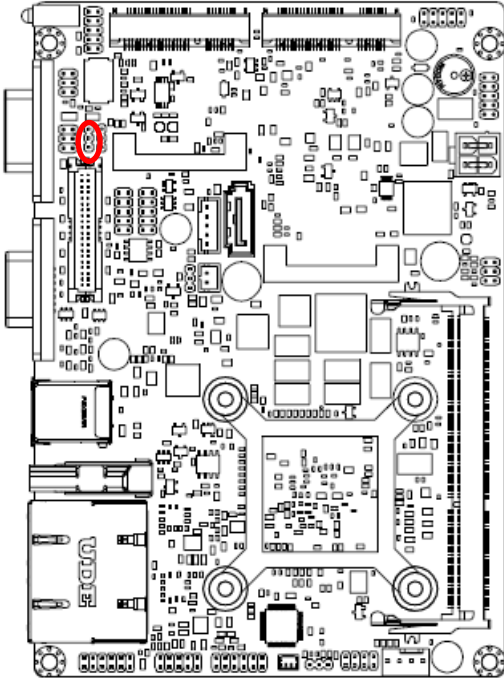

Signal	PIN
EC_SMCLK_DEBUG	1
EC_SMDAT_DEBUG	2
GND	3

2.4.20 LVDS connector (JLVDS1)

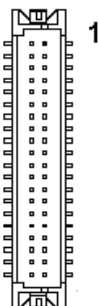
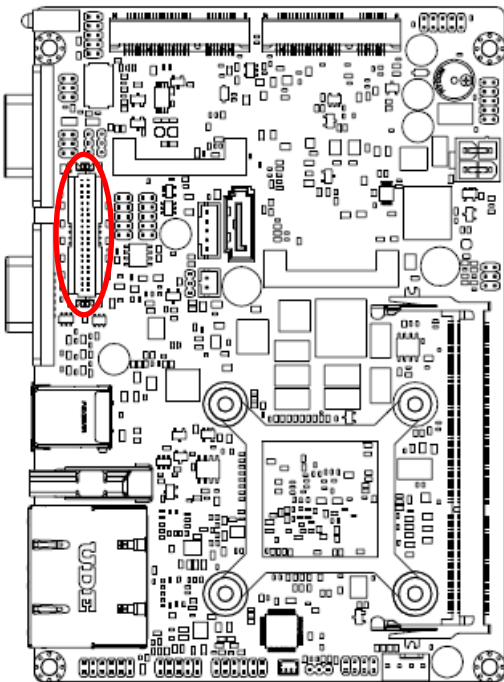

Signal	PIN	PIN	Signal
+5V	2	1	+3.3V
+5V	4	3	+3.3V
NC	6	5	NC
GND	8	7	GND
LVDS_DATA0_P	10	9	LVDS_DATA1_P
LVDS_DATA0_N	12	11	LVDS_DATA1_N
GND	14	13	GND
LVDS_DATA2_P	16	15	LVDS_DATA3_P
LVDS_DATA2_N	18	17	LVDS_DATA3_N
GND	20	19	GND
LVDS_DATA4_P	22	21	LVDS_DATA5_P
LVDS_DATA4_N	24	23	LVDS_DATA5_N
GND	26	25	GND
LVDS_DATA6_P	28	27	LVDS_DATA7_P
LVDS_DATA6_N	30	29	LVDS_DATA7_N
GND	32	31	GND
LVDS_CLK1_P	34	33	LVDS_CLK2_P
LVDS_CLK1_N	36	35	LVDS_CLK2_N
GND	38	37	GND
+12V	40	39	+12V

2.4.21 Power connector (PWR1)

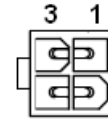
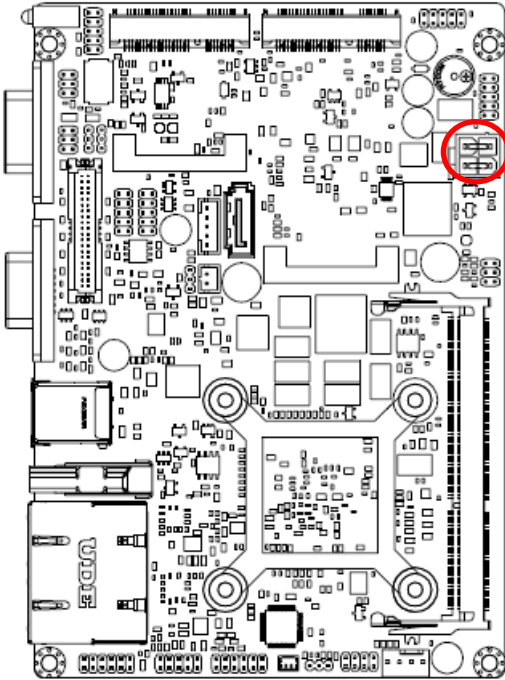

Signal	PIN	PIN	Signal
VIN_IN	3	1	GND
VIN_IN	4	2	GND

2.4.22 SATA power connector (SATA_PWR1)

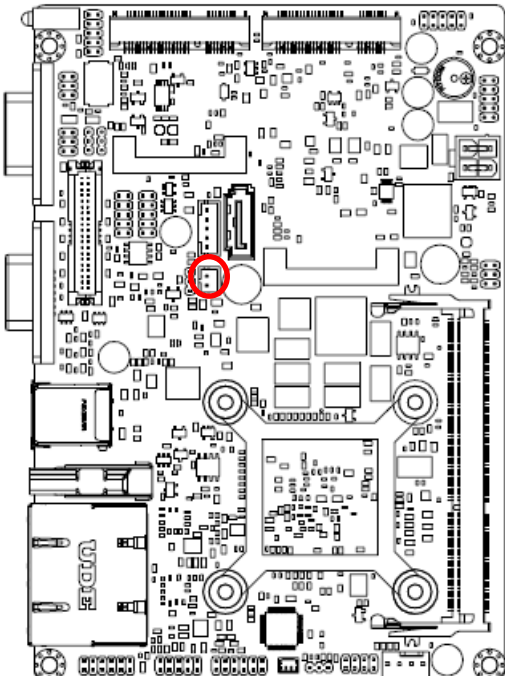

Signal	PIN
+5V	2
GND	1

2.4.23 Audio connector (JAUDIO1)

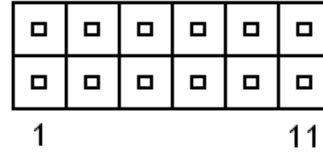
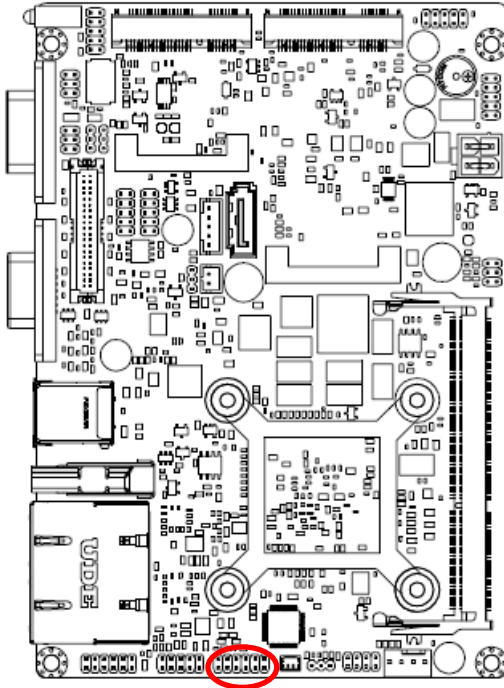

Signal	PIN	PIN	Signal
FRONT-R-OUT	1	2	FRONT-L-OUT
HD_AGND	3	4	HD_AGND
LINE1-R-IN	5	6	LINE1-L-IN
MIC1-R-IN	7	8	MIC1-L-IN
FRONT-JD	9	10	LINE1-JD
MIC1-JD	11	12	HD_AGND

2.4.23.1 Signal Description – Audio connector (JAUDIO1)

Signal	Signal Description
LINE1_JD	AUDIO IN (LINE_RIN/LIN)sense pin
FRONT_JD	AUDIO Out(ROUT/LOUT) sense pin
MIC1_JD	MIC IN (MIC_RIN/LIN) sense pin

3. BIOS Setup

3.1 Introduction

The BIOS setup program allows users to modify the basic system configuration. In this following chapter will describe how to access the BIOS setup program and the configuration options that may be changed.

3.2 Starting Setup

The AMI BIOS™ is immediately activated when you first power on the computer. The BIOS reads the system information contained in the NVRAM and begins the process of checking out the system and configuring it. When it finishes, the BIOS will seek an operating system on one of the disks and then launch and turn control over to the operating system.

While the BIOS is in control, the Setup program can be activated in one of two ways:

By pressing or <F2> immediately after switching the system on, or

By pressing the or <F2> key when the following message appears briefly at the left-top of the screen during the POST (Power On Self Test).

Press or <F2> to enter SETUP

If the message disappears before you respond and you still wish to enter Setup, restart the system to try again by turning it OFF then ON or pressing the "RESET" button on the system case. You may also restart by simultaneously pressing <Ctrl>, <Alt>, and <Delete> keys. If you do not press the keys at the correct time and the system does not boot, an error message will be displayed and you will again be asked to.

Press F1 to Continue, DEL to enter SETUP

3.3 Using Setup

In general, you use the arrow keys to highlight items, press <Enter> to select, use the PageUp and PageDown keys to change entries, press <F1> for help and press <Esc> to quit. The following table provides more detail about how to navigate in the Setup program using the keyboard.

Button	Description
↑	Move to previous item
↓	Move to next item
←	Move to the item in the left hand
→	Move to the item in the right hand
Esc key	Main Menu -- Quit and not save changes into NVRAM Status Page Setup Menu and Option Page Setup Menu -- Exit current page and return to Main Menu
+ key	Increase the numeric value or make changes
- key	Decrease the numeric value or make changes
F1 key	General help, only for Status Page Setup Menu and Option Page Setup Menu
F2 key	Previous Values.
F3 key	Optimized defaults
F4 key	Save & Exit Setup

- **Navigating Through The Menu Bar**

Use the left and right arrow keys to choose the menu you want to be in.



Note: Some of the navigation keys differ from one screen to another.

- **To Display a Sub Menu**

Use the arrow keys to move the cursor to the sub menu you want. Then press <Enter>. A “>” pointer marks all sub menus.

3.4 Getting Help

Press F1 to pop up a small help window that describes the appropriate keys to use and the possible selections for the highlighted item. To exit the Help Window press <Esc> or the F1 key again.

3.5 In Case of Problems

If, after making and saving system changes with Setup, you discover that your computer no longer is able to boot, the AMI BIOS supports an override to the NVRAM settings which resets your system to its defaults.

The best advice is to only alter settings which you thoroughly understand. To this end, we strongly recommend that you avoid making any changes to the chipset defaults. These defaults have been carefully chosen by both BIOS Vendor and your systems manufacturer to provide the absolute maximum performance and reliability. Even a seemingly small change to the chipset setup has the potential for causing you to use the override.

3.6 BIOS setup

Once you enter the Aptio Setup Utility, the Main Menu will appear on the screen. The Main Menu allows you to select from several setup functions and exit choices. Use the arrow keys to select among the items and press <Enter> to accept and enter the sub-menu.

3.6.1 Main Menu

This section allows you to record some basic hardware configurations in your computer and set the system clock.



3.6.1.1 System Language

This option allows choosing the system default language.

3.6.1.2 System Date

Use the system date option to set the system date. Manually enter the day, month and year.

3.6.1.3 System Time

Use the system time option to set the system time. Manually enter the hours, minutes and seconds.



Note: The BIOS setup screens shown in this chapter are for reference purposes only, and may not exactly match what you see on your screen. Visit the Avalue website (www.avalue.com.tw) to download the latest product and BIOS information.

ECM-BYT2 User's Manual

3.6.2 Advanced Menu

This section allows you to configure your CPU and other system devices for basic operation through the following sub-menus.

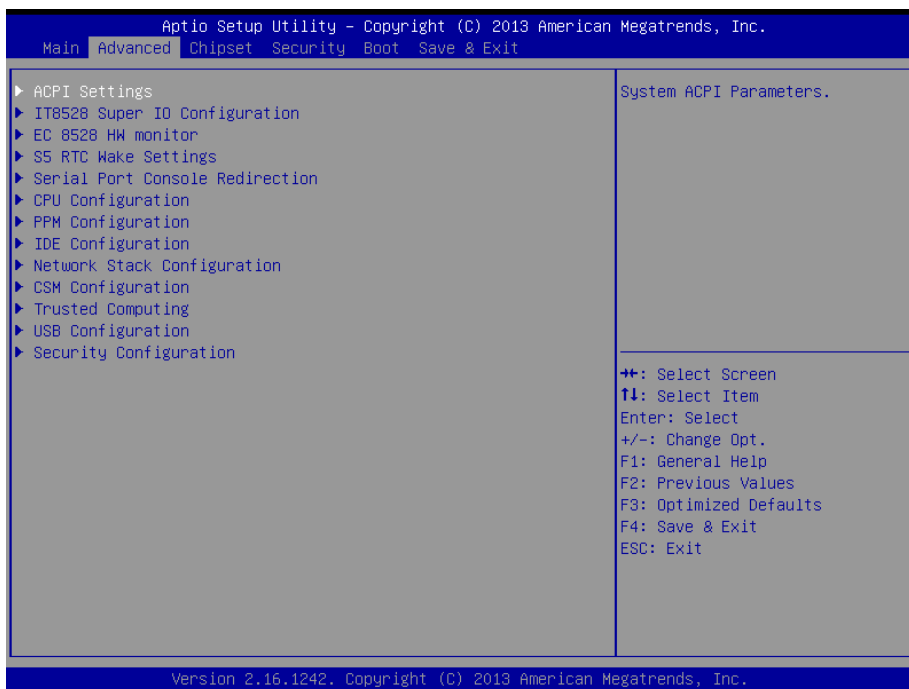

3.6.2.1 ACPI Settings

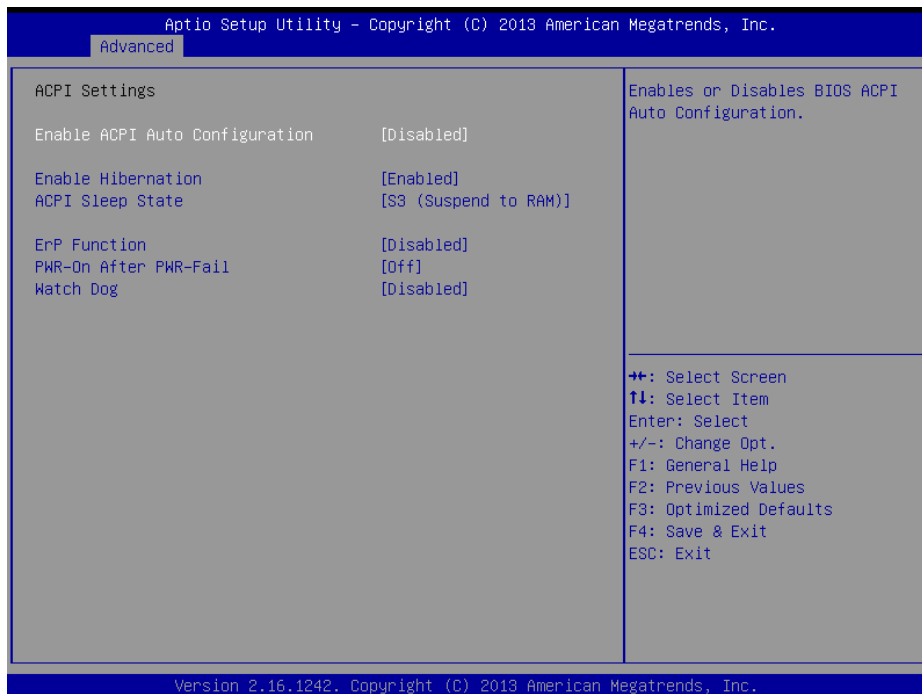

Item	Options	Description
Enable ACPI Auto Configuration	Disabled[Default], Enabled	Enables or Disables BIOS ACPI Auto Configuration.

ECM-BYT2 User's Manual

Enable Hibernation	Disabled Enabled[Default],	Enables or Disables System ability to Hibernate (OS/S4 Sleep State). This option may be not effective with some OS.
ACPI Sleep State	Suspend Disabled, S3 (Suspend to RAM) [Default]	Select the highest ACPI sleep state the system will enter when the SUSPEND button is pressed.
ErP Function	Disabled[Default], Enabled	ErP Function (Deep S5).
PWR-On After PWR-Fail	Off[Default] On Last state	AC loss resume.
Watch Dog	Disabled[Default], 30 sec 40 sec 50 sec 1 min 2 min 10 min 30 min	Select WatchDog.

3.6.2.2 IT8528 Super IO Configuration

You can use this item to set up or change the IT8528 Super IO configuration for serial ports. Please refer to 3.6.2.2.1 and 3.6.2.2.2 for more information.

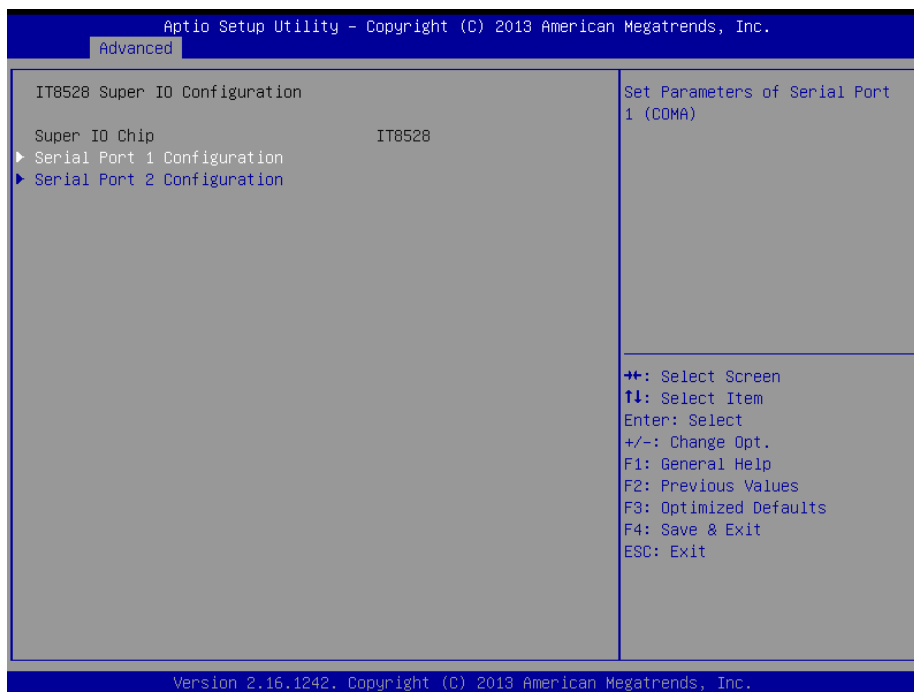

Item	Description
Serial Port 1 Configuration	Set Parameters of Serial Port 1 (COMA).
Serial Port 2 Configuration	Set Parameters of Serial Port 2 (COMB).

3.6.2.2.1 Serial Port 1 Configuration

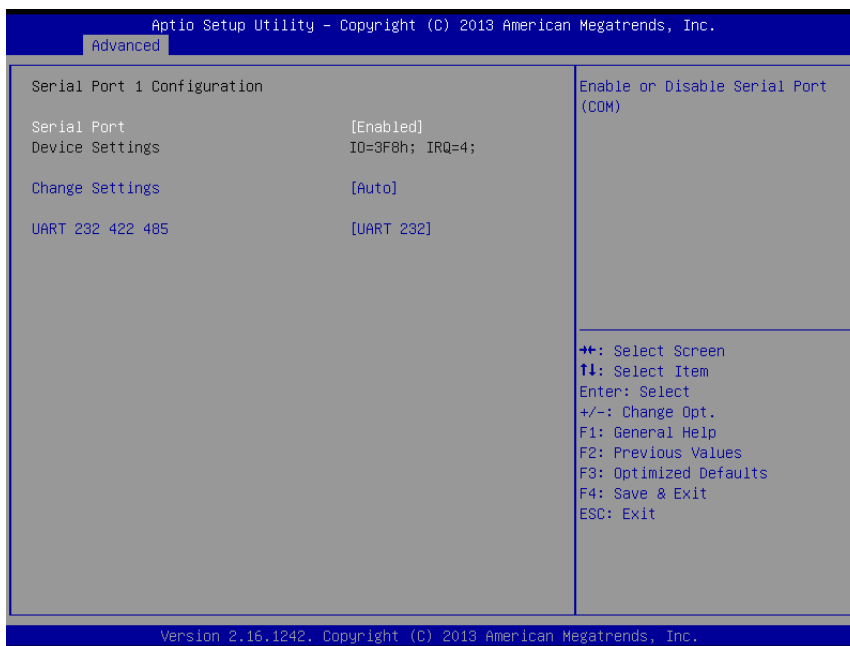

Item	Option	Description
Serial Port	Enabled[Default], Disabled	Enable or Disable Serial Port (COM).
Change Settings	Auto[Default] IO=3F8h; IRQ=4; IO=3F8h; IRQ=3,4,5,6,7,9,10,11,12; IO=2F8h; IRQ=3,4,5,6,7,9,10,11,12; IO=3E8h; IRQ=3,4,5,6,7,9,10,11,12; IO=2E8h; IRQ=3,4,5,6,7,9,10,11,12;	Select an optimal setting for Super IO Device.
UART 232 422 485	UART 232[Default], UART 422, UART 485	Change the Serial Port as RS232/ 422/ 485

ECM-BYT2 User's Manual

3.6.2.2 Serial Port 2 Configuration

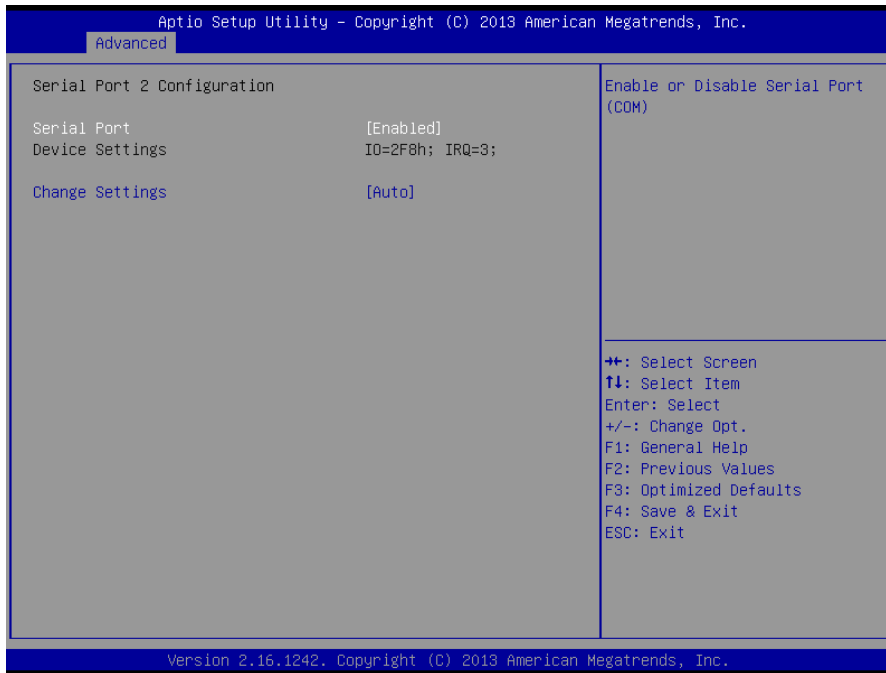

Item	Option	Description
Serial Port	Enabled[Default], Disabled	Enable or Disable Serial Port (COM).
Change Settings	Auto[Default] IO=2F8h; IRQ=3; IO=3F8h; IRQ=3,4,5,6,7,9,10,11,12; IO=2F8h; IRQ=3,4,5,6,7,9,10,11,12; IO=3E8h; IRQ=3,4,5,6,7,9,10,11,12; IO=2E8h; IRQ=3,4,5,6,7,9,10,11,12;	Select an optimal setting for super IO Device.

3.6.2.3 H/W Monitor



ECM-BYT2 User's Manual

Item	Options	Description
Smart Fan Function	Enabled, Disabled [Default]	Enables or Disables Smart Fan.

3.6.2.4 S5 RTC Wake Settings

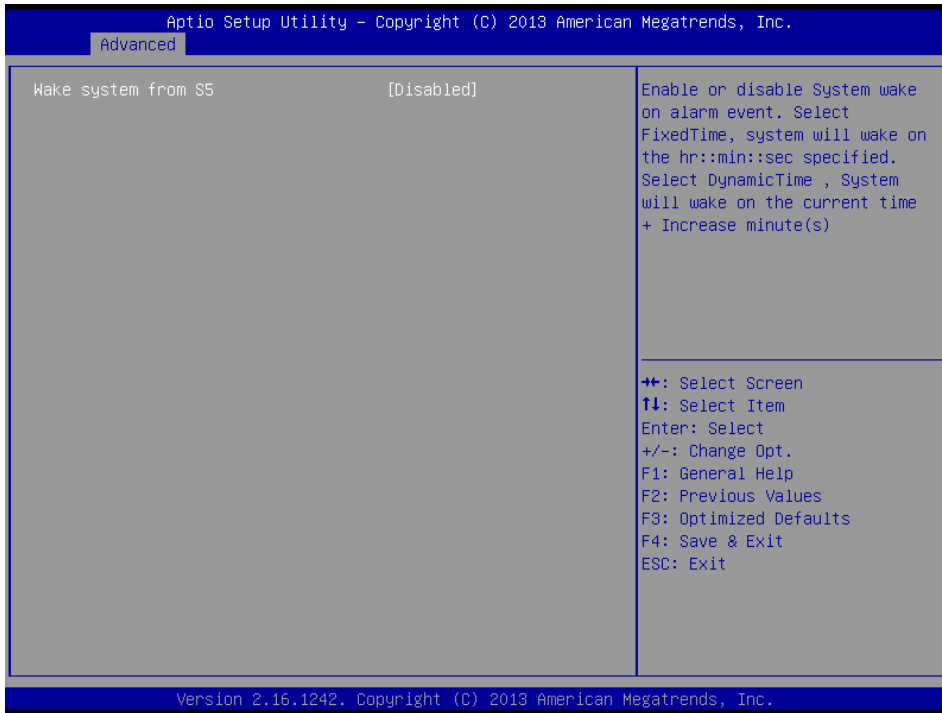

Item	Options	Description
Wake system from S5	Disabled [Default] , Fixed Time Dynamic Time	Enable or disable System wake on alarm event. Select Fixed Time, system will wake on the hr::min::sec specified. Select Dynamic Time, System will wake on the current time + Increase minute(s).

ECM-BYT2 User's Manual

3.6.2.5 Serial Port Console Redirection

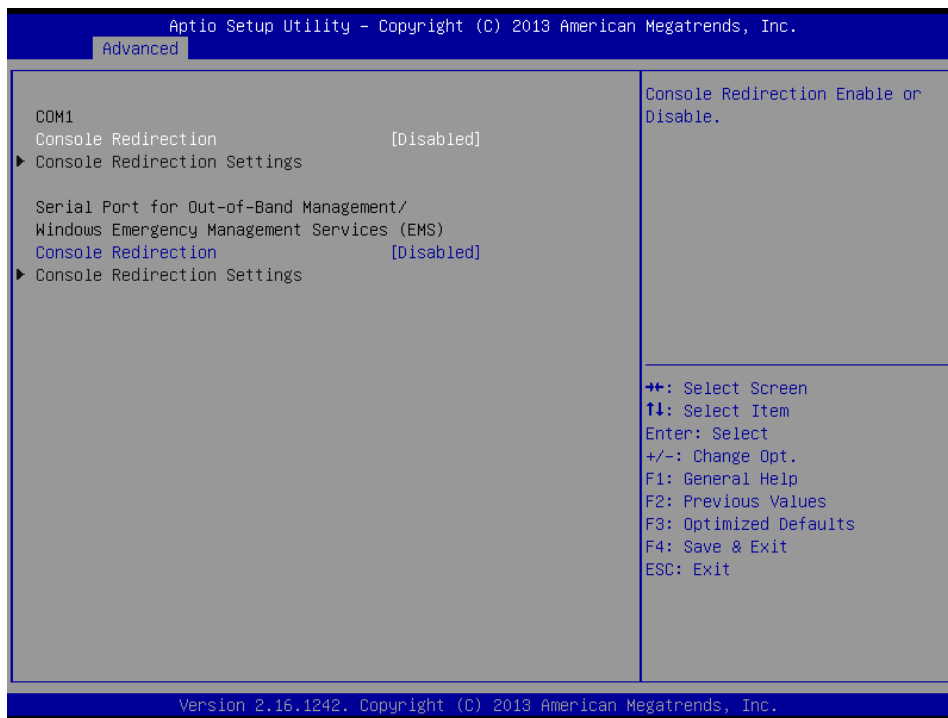

Item	Options	Description
Console Redirection	Disabled[Default], Enabled	Console Redirection Enable or Disable.

3.6.2.6 CPU Configuration

Use the CPU configuration menu to view detailed CPU specification and configure the CPU.

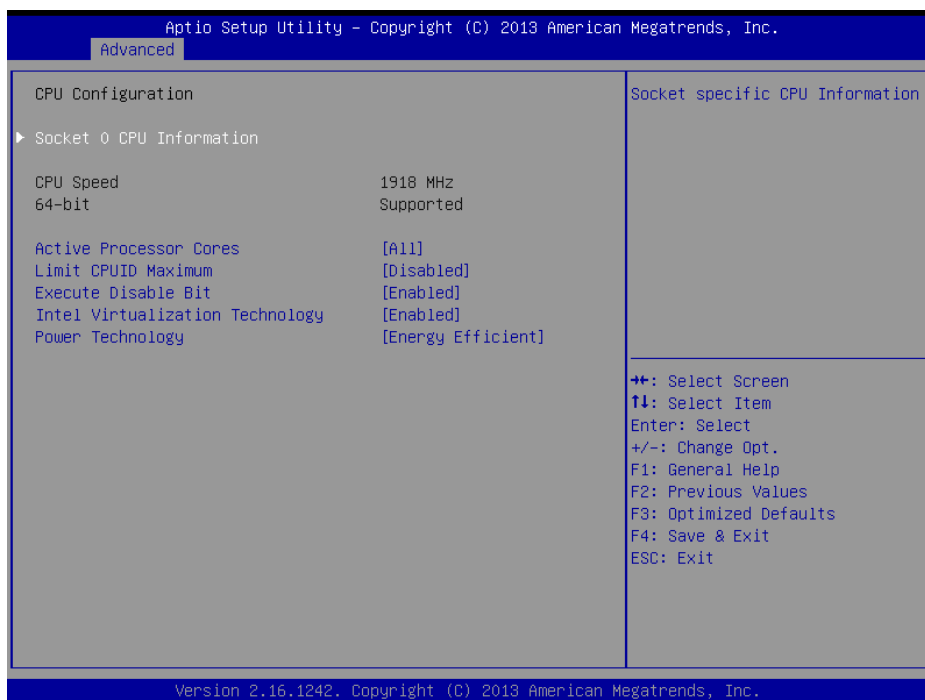

ECM-BYT2 User's Manual

Item	Options	Description
Active Processor Cores	All[Default], 1	Number of cores to enable in each processor package.
Limit CPUID Maximum	Disabled[Default], Enabled	Disabled for Windows XP.
Execute Disable Bit	Disabled, Enabled[Default]	XD can prevent certain classes of malicious buffer overflow attacks when combined with a supporting OS (Windows Server 2003 SP1, Windows XP SP2, SuSE Linux 9.2, RedHat Enterprise 3 Update 3.)
Intel Virtualization Technology	Disabled, Enabled[Default]	When enabled, a VMM can utilize the additional hardware capabilities provided by Virtualization Technology.
Power Technology	Disabled, Energy Efficient[Default] Custom	Enable the power management features.

3.6.2.7 PPM Configuration

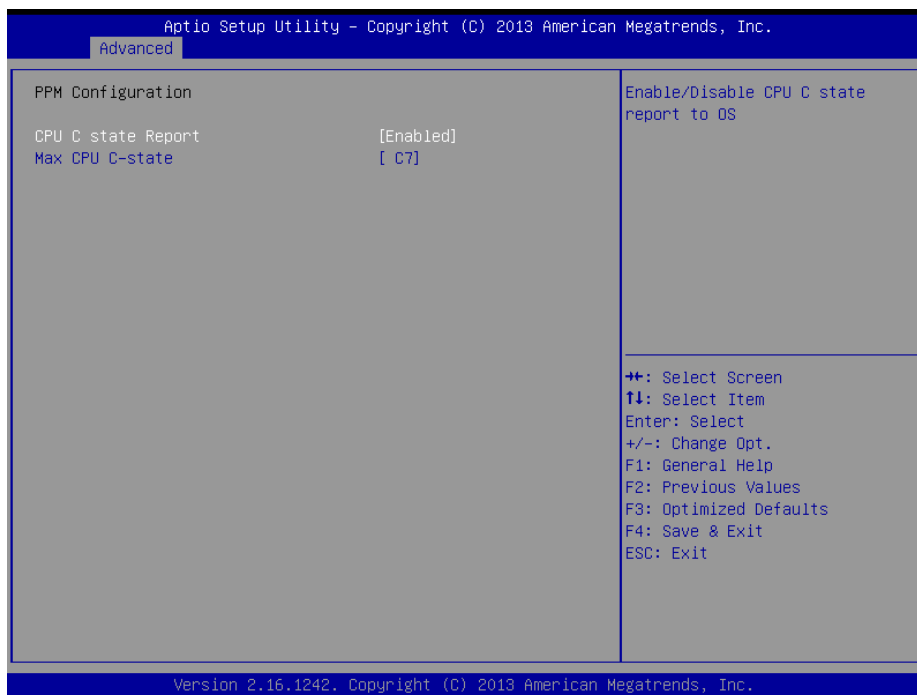

Item	Options	Description
CPU C state Report	Disabled, Enabled[Default]	Enable/Disable CPU C state report to OS.
Max CPU C-state	C1/C6/C7[Default]	This option controls Max C state that the processor will support.

3.6.2.8 IDE Configuration

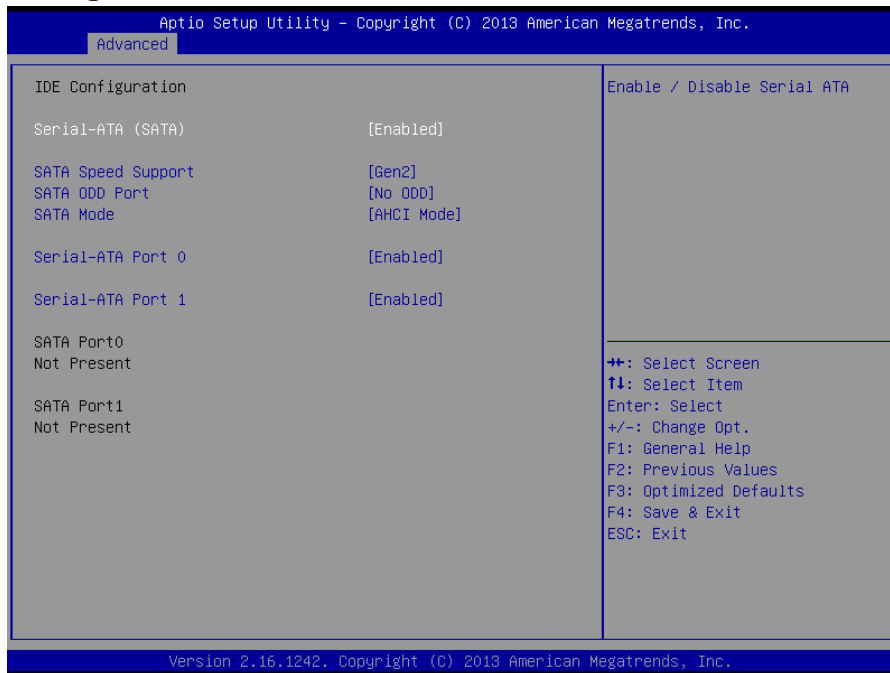

Item	Options	Description
Serial-ATA (SATA)	Enabled[Default] Disabled,	Enable/Disable Serial ATA.
SATA Speed Support	Gen1 Gen2[Default]	SATA Speed Support Gen1 or Gen2.
SATA ODD Port	Port0 ODD Port1 ODD No ODD[Default]	SATA ODD is Port0 or Port1.
SATA Mode	IDE Mode AHCI Mode[Default]	Select IDE/AHCI.
Serial-ATA Port 0/1	Enabled[Default] Disabled,	Enable/Disable Serial ATA Port0/1.

ECM-BYT2 User's Manual

3.6.2.9 Network Stack Configuration



Item	Options	Description
Network Stack	Enabled Disabled[Default]	Enable/Disable UEFI Network Stack.

3.6.2.10 CSM Configuration



Item	Options	Description
CSM Support	Enabled[Default] Disabled,	Enable/Disable CSM Support.

ECM-BYT2 User's Manual

GateA20 Active	Upon Request[Default] Always	UPON REQUEST – GA20 can be disabled using BIOS services. ALWAYS – go not allow disabling GA20; this option is useful when any RT code is executed above 1MB.
Option ROM Messages	Force BIOS[Default] Keep Current	Set display mode for Option ROM.
INT19 Trap Response	Immediate[Default] Postponed	BIOS reaction on INT19 trapping by Option ROM: IMMEDIATE – execute the trap right away; POSTPONED – execute the traps during legacy boot.
Boot option filter	UEFI and Legacy Legacy only[Default] UEFI only	This option controls Legacy/UEFI ROMs priority.
Network	Do not launch[Default] UEFI only Legacy only	Controls the execution of UEFI and Legacy PXE OpROM.
Storage	Do not launch UEFI only Legacy only[Default]	Controls the execution of UEFI and Legacy Storage OpROM.
Video	Do not launch UEFI only Legacy only[Default]	Controls the execution of UEFI and Legacy Video OpROM.
Other PCI devices	UEFI only Legacy only[Default],	Determines OpROM execution policy for devices other than Network, Storage, or Video.

3.6.2.11 Trusted Computing

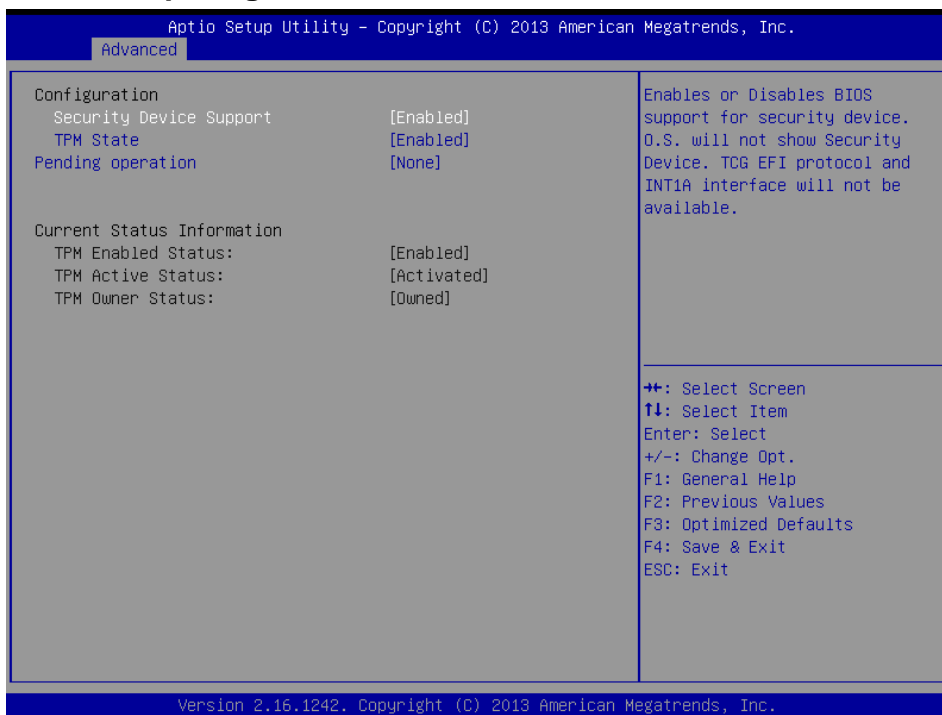

ECM-BYT2 User's Manual

Item	Options	Description
Security Device Support	Enabled[Default] Disabled,	Enable/Disable BIOS support for security device. O.S. will not show Security Device. TCG EFI protocol and INT1A interface will not be available.
TPM State	Enabled Disabled[Default],	Enable/Disable Security Device. NOTE: Your Computer will reboot during restart in order to change State of the Device.
Pending operation	None[Default] Enable Take Ownership Disable Take Ownership TPM Clear	Schedule an Operation for the Security Device. NOTE: Your Computer will reboot during restart in order to change State of Security Device.

3.6.2.12 USB Configuration

The USB Configuration menu helps read USB information and configures USB settings.

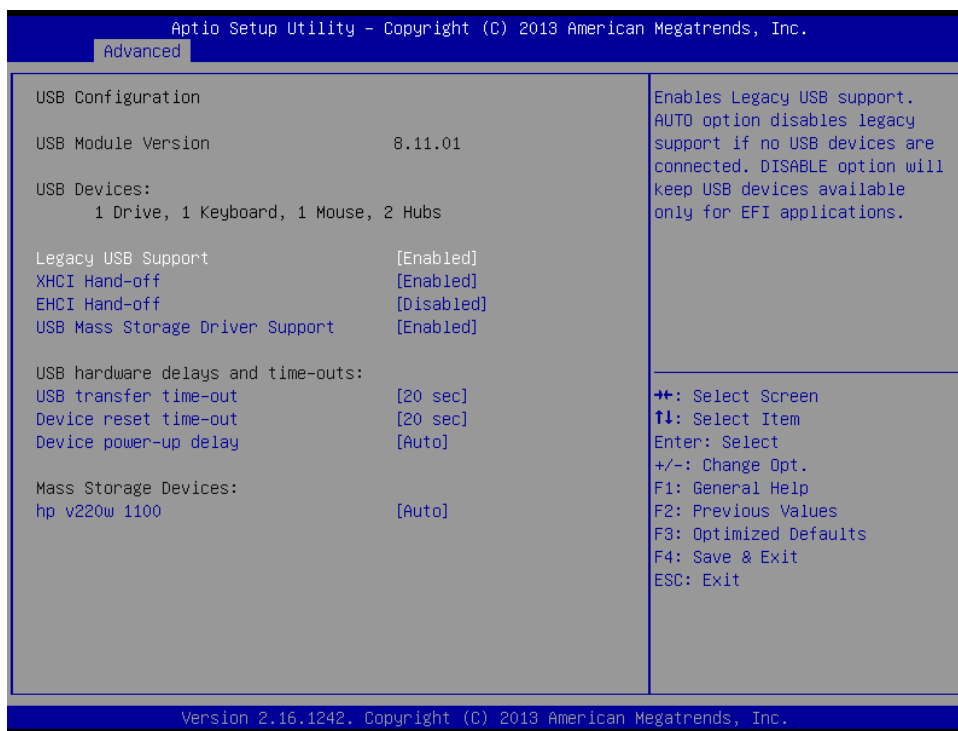

Item	Options	Description
Legacy USB Support	Enabled[Default] Disabled Auto	Enables Legacy USB support. AUTO option disables legacy support if no USB devices are connected. DISABLE option will keep USB devices available only for EFI applications.
XHCI Hand-off	Enabled[Default] Disabled	This is a workaround for OSes without XHCI hand-off support. The XHCI ownership change should be claimed by XHCI driver.
EHCI Hand-off	Enabled Disabled[Default]	This is a workaround for OSes without EHCI hand-off support. The EHCI ownership change should be claimed by EHCI driver.

ECM-BYT2 User's Manual

USB Mass Storage Driver Support	Enabled[Default] Disabled	Enable/Disable USB Mass Storage Driver Support.
USB transfer time-out	1 sec 5 sec 10 sec 20 sec[Default]	The time-out value for Control, Bulk, and Interrupt transfers.
Device reset time-out	10 sec 20 sec[Default] 30 sec 40 sec	USB mass storage device Start Unit command time-out.
Device power-up delay	Auto[Default] Manual	Maximum time the device will take before it properly reports itself to the Host Controller. 'Auto' uses default value: for a Root port it is 100ms, for a Hub port the delay is taken form Hub descriptor.

3.6.2.13 Security Configuration



Item	Options	Description
TXE EOP Message	Disabled Enabled[Default],	Send EOP Message Before Enter OS.
Intel® AT	Disabled[Default] Enabled,	Enable/Disable BIOS AT Code from Running.
Inter® AT Platform PBA	Disabled[Default], Enabled	Enable/Disable BIOS AT Code from Running.
TXE OVERWRITE	OVERWRITE NORMAL[Default]	TXE OVERWRITE. NORMAL:Over Write Pin as high. (TXE enabled) OVERWRITE:OverWrite Pin as low. (TXE disabled).

ECM-BYT2 User's Manual

3.6.3 Chipset

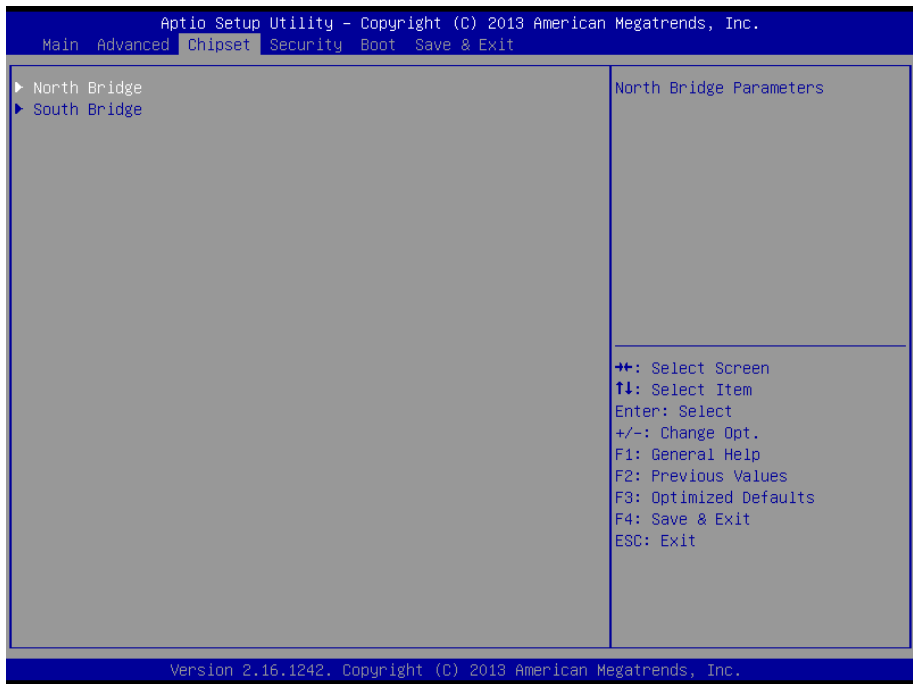

3.6.3.1 North Bridge

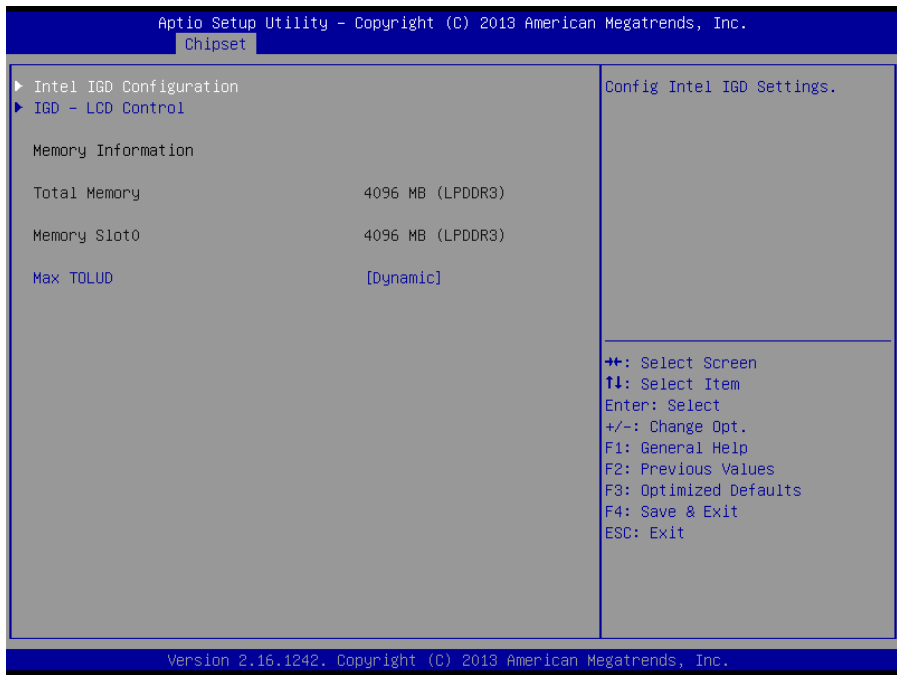

Item	Option	Description
Max TOLUD	Dynamic[Default]	Maximum Value of TOLUD.
	2 GB	
	2.25 GB	
	2.5 GB	
	2.75 GB	
	3 GB	

ECM-BYT2 User's Manual

3.6.3.1.1 Intel IGD Configuration

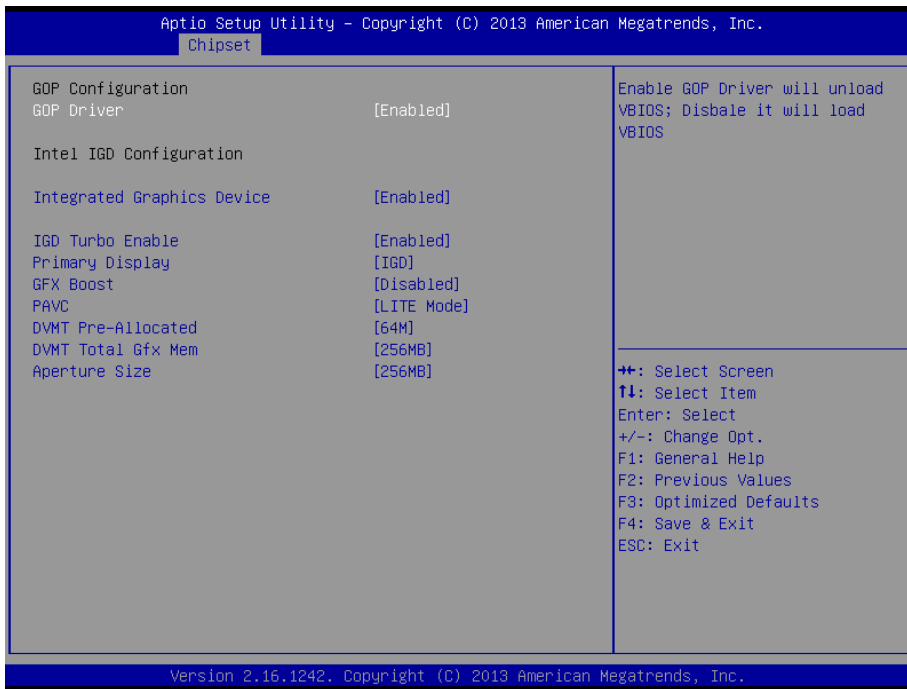

Item	Option	Description
GOP Driver	Enabled[Default], Disabled	Enable GOP Driver will unload VBIOS; Disable it will load VBIOS.
Integrated Graphics Device	Enabled[Default], Disabled	Enable: Enable Integrated Graphics Device (IGD) when selected as the Primary Video Adaptor. Disable: Always disable IGD.
IGD Turbo Enable	Enabled[Default], Disabled	Enable: Enable IGD Turbo Enable. Disable: IGD Turbo Disable.
Primary Display	Auto IGD[Default] PCIe	Select which of IGD/PCI Graphics device should be Primary Display.
GFX Boost	Enabled, Disabled[Default]	Enable/Disable GFX Boost.
PAVC	Disabled LITE Mode[Default] SERPENT Mode	Enable/Disable Protected Audio Video Control.
DVMT Pre-Allocated	64M[Default]/96M/128M/160M/192M/ 224M/256M/288M/320M/352M/ 384M/416M/448M/ 480M/512M	Select DVMT 5.0 Pre-Allocated (Fixed) Graphics Memory size used by the Internal Graphics Device.
DVMT Total Gfx Mem	128MB 256MB[Default] Max	Select DVMT 5.0 Total Graphics Memory size used by the Internal Graphics Device.
Aperture Size	128MB 256MB[Default]	Select the Aperture Size.

ECM-BYT2 User's Manual

3.6.3.1.2 IGD - LCD Control

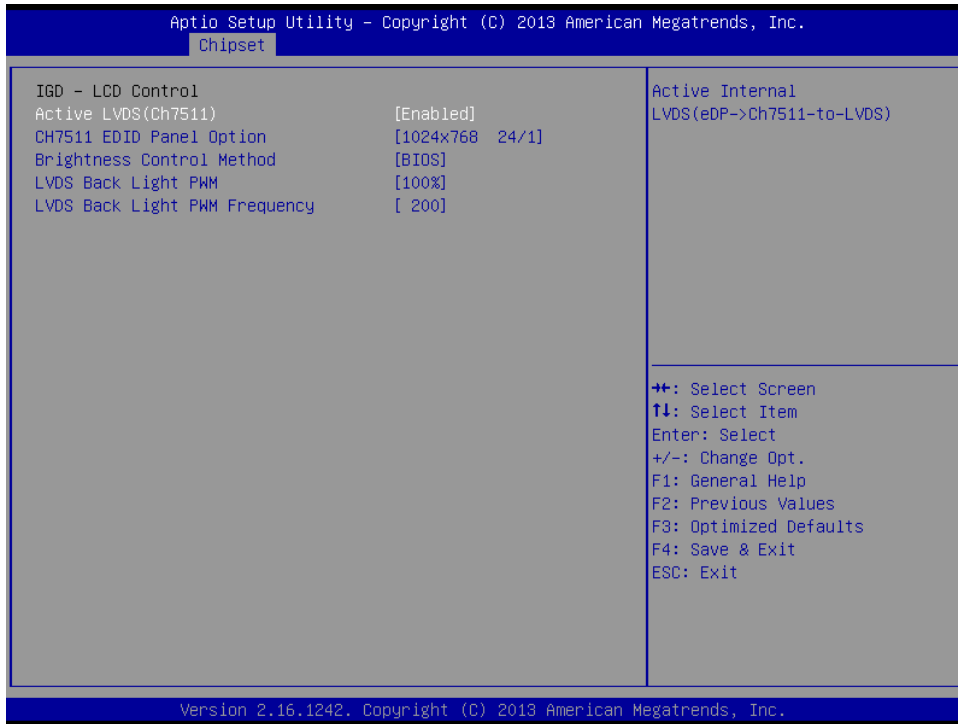

Item	Option	Description
Active LVDS (Ch7511)	Enabled[Default] Disabled	Active Internal LVDS(eDP->Ch7511-to-LVDS).
CH7511 EDID Panel Option	1024x768 24/1[Default] 800x600 18/1 1024x768 18/1 1366x768 18/1 1024x600 18/1 1280x800 18/1 1920x1200 24/2 640x480 18/1 800x480 18/1 1920x1080 18/2 1280x1024 24/2 1440x900 18/2 1600x1200 24/2 1366x768 24/1 1920x1080 24/2 1680x1050 24/2	Port1-EDP to LVDS (Chrotel 7511) Panel EDID Option.
Brightness Control Method	BIOS[Default] BR Button VR	LVDS Brightness Control Method. 1.BIOS 2.Brithtness Button 3.Variable Resistor.
LVDS Back Light PWM	00% 25% 50% 75% 100%[Default]	Select LVDS back light PWM duty.

ECM-BYT2 User's Manual

LVDS Back Light PWM Frequency	200[Default]	Select LVDS back light PWM Frequency.
	300	
	400	
	500	
	700	
	1k	
	2k	
	3k	
5k		

3.6.3.2 South Bridge

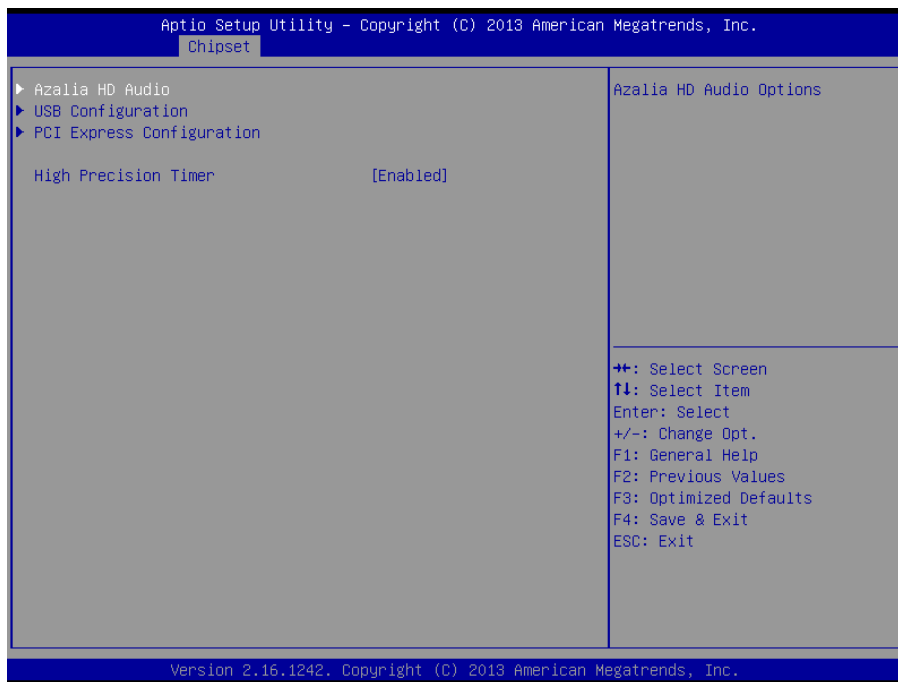

Item	Option	Description
High Precision Timer	Disabled Enabled[Default]	Enable or Disable the High Precision Event Timer.

ECM-BYT2 User's Manual

3.6.3.2.1 Azalia HD Audio

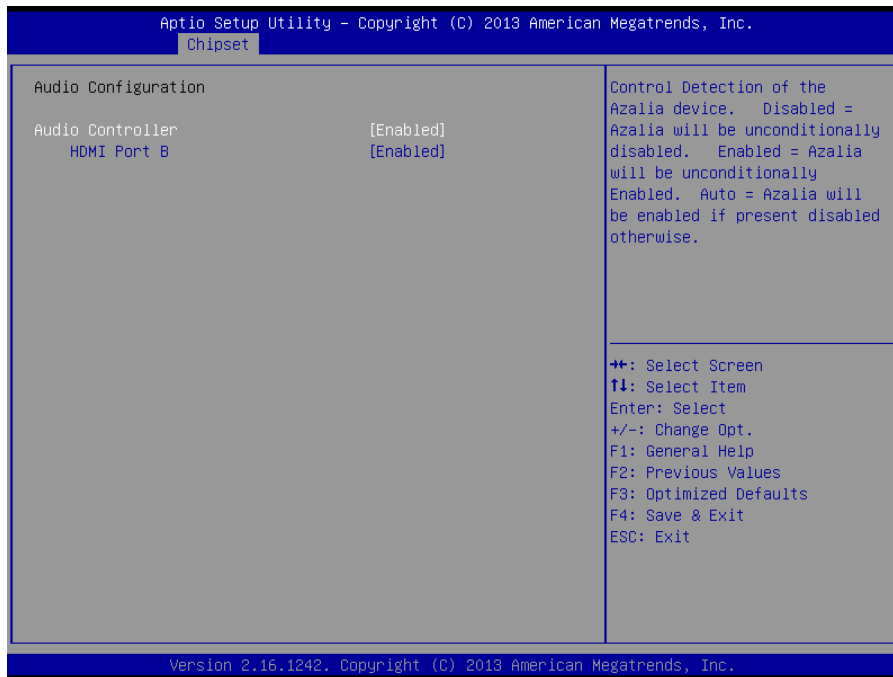

Item	Option	Description
Audio Controller	Enabled[Default], Disabled	Control Detection of the Azalia device. Disabled = Azalia will be unconditionally disabled. Enabled = Azalia will be unconditionally Enabled. Auto = Azalia will be enabled if present disabled otherwise.
HDMI Port B	Enabled[Default], Disabled	Enable/Disable HDMI Port B.

3.6.3.2.2 USB Configuration

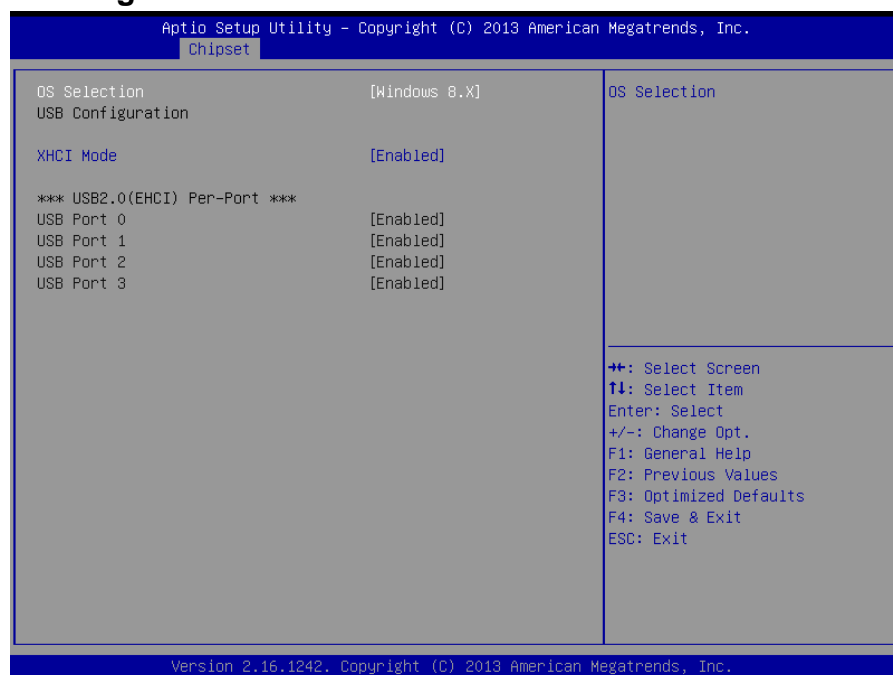

ECM-BYT2 User's Manual

Item	Option	Description
OS Selection	Windows 8.X[Default] Android Windows 7	Please select the corresponding type of Windows for OS installation. Please change the item of OS selection to Windows 7 if you intend to install Windows 7 OS; Please change the item of OS selection to Windows 8.X if you intend to install Windows 8 OS.
XHCI Mode	Enabled[Default], Disabled	Mode of operation of xHCI controller.

3.6.3.2.3 PCI Express Configuration

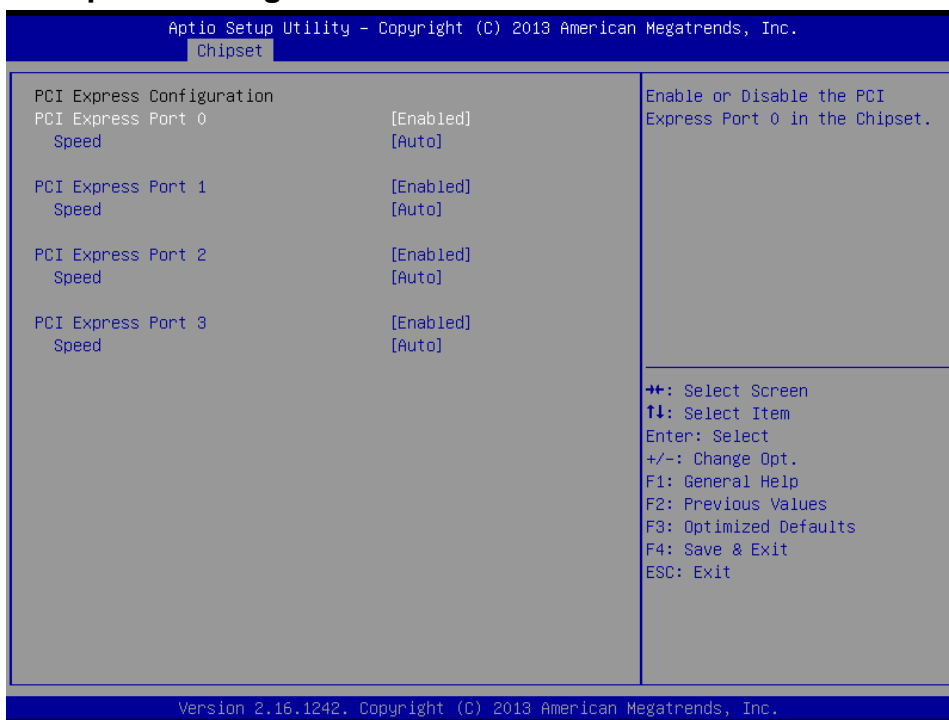

Item	Option	Description
PCI Express Port 0/1/2/3	Enabled[Default], Disabled	Enable or Disable the PCI Express Port 0/1/2/3 in the Chipset.
Speed	Auto[Default] Gen 2 Gen 1	Configure PCIe Port Speed.

ECM-BYT2 User's Manual

3.6.4 Security

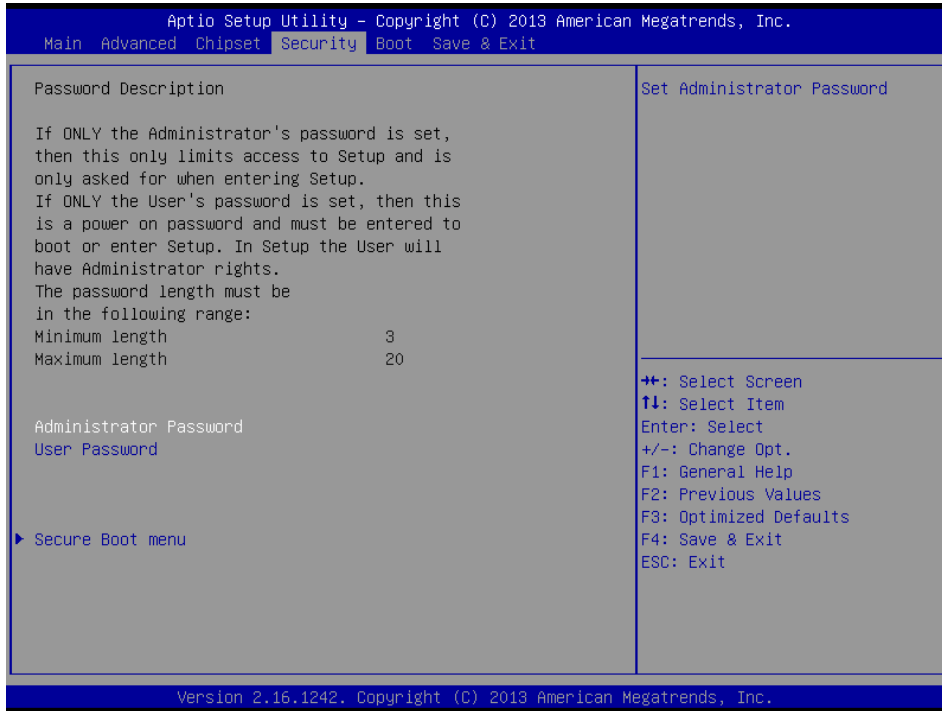

- **Administrator Password**

Set setup Administrator Password

- **User Password**

Set User Password

3.6.4.1 Secure Boot menu



ECM-BYT2 User's Manual

Item	Option	Description
Secure Boot	Disabled[Default] Enabled	Secure Boot can be enabled if 1. System running in User mode with enrolled Platform Key(PK) 2. CSM function is disabled.
Secure Boot Mode	Standard Custom[Default]	Secure Boot mode selector. 'Custom' Mode enables users to change Image Execution policy and manage Secure Boot Keys.

3.6.4.1.1 Key Management

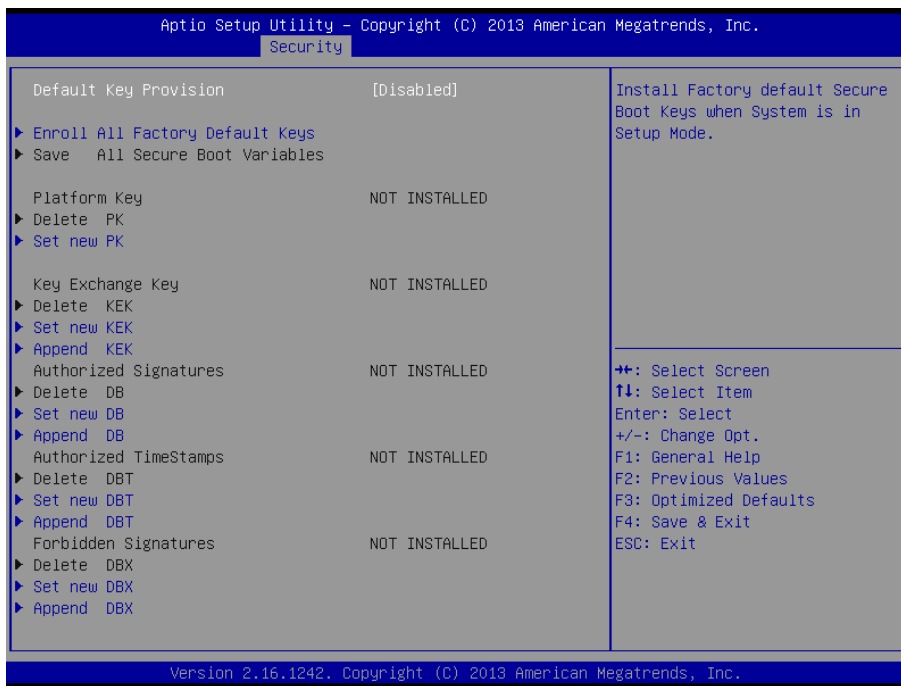

Item	Option	Description
Default Key Provision	Enabled, Disabled[Default]	Install Factory default Secure Boot Keys when System is in Setup Mode.

ECM-BYT2 User's Manual

3.6.5 Boot

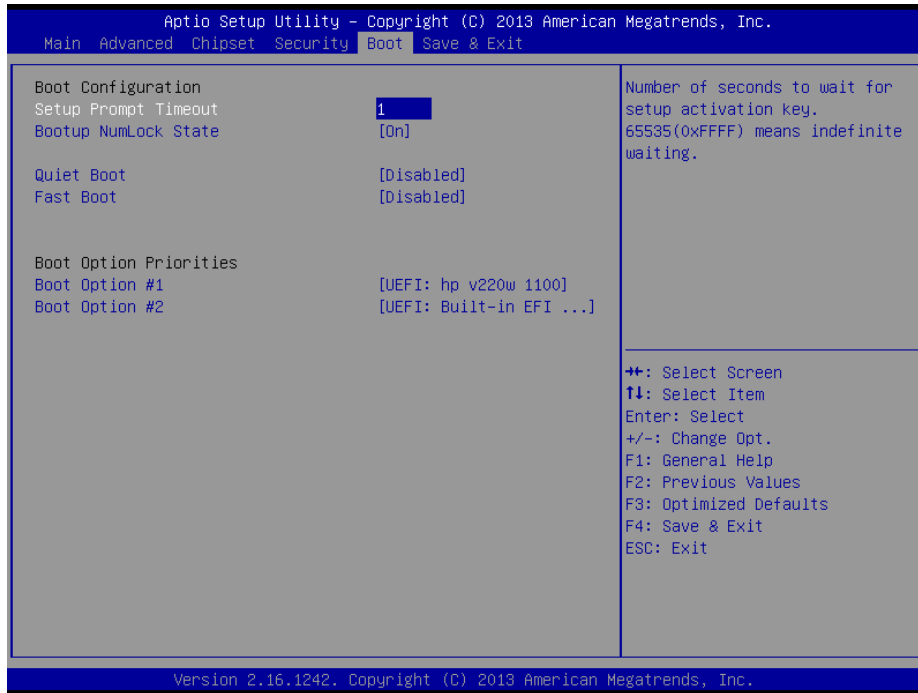

Item	Option	Description
Setup Prompt Timeout	1~ 65535	Number of seconds to wait for setup activation key. 65535(0xFFFF) means indefinite waiting.
Bootup NumLock State	On[Default] Off	Select the Keyboard NumLock state
Quiet Boot	Disabled[Default] Enabled	Enables or disables Quiet Boot option
Fast Boot	Disabled[Default] Enabled	Enables or disables boot with initialization of a minimal set of devices required to launch active boot option. Has no effect for BBS boot options.
Boot Option #1/2	Set the system boot order.	

ECM-BYT2 User's Manual

3.6.6 Save and exit

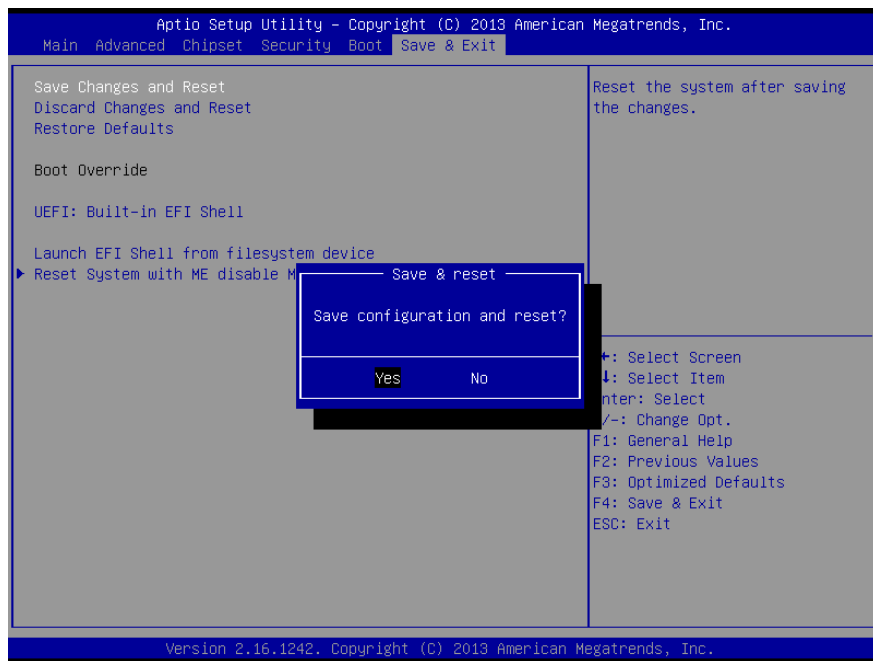
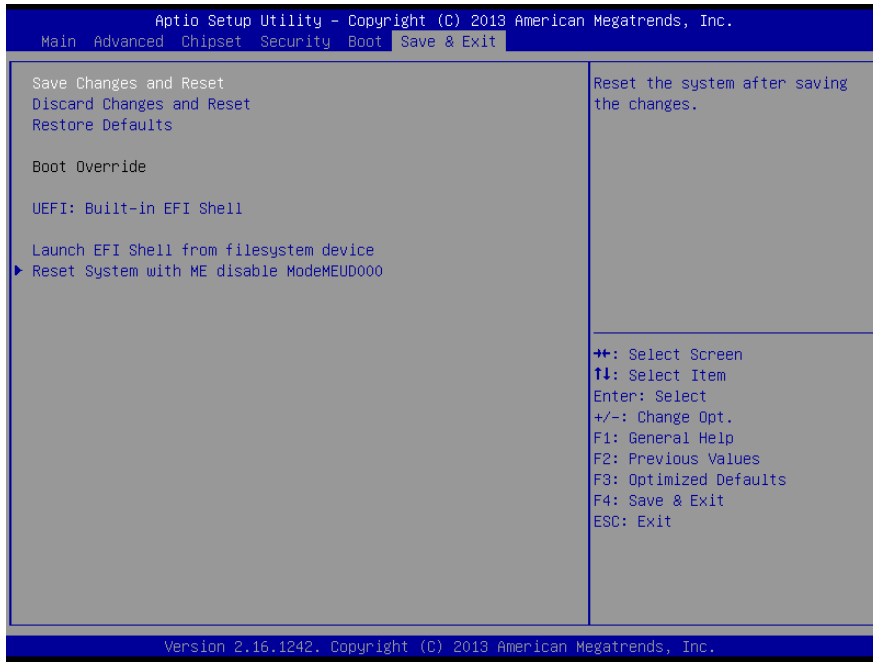

3.6.6.1 Save Changes and Reset

Reset the system after saving the changes.

3.6.6.2 Discard Changes and Reset

Any changes made to BIOS settings during this session of the BIOS setup program are discarded. The setup program then exits and reboots the controller.

ECM-BYT2 User's Manual

3.6.6.3 *Restore Defaults*

This option restores all BIOS settings to the factory default. This option is useful if the controller exhibits unpredictable behavior due to an incorrect or inappropriate BIOS setting.

3.6.6.4 *Launch EFI Shell from filesystem device*

Attempts to Launch EFI Shell application (Shellx64.efi) from one of the available filesystem devices.

4. Drivers Installation



Note: Installation procedures and screen shots in this section are for your reference and may not be exactly the same as shown on your screen.

4.1 Install Chipset Driver

Insert the Supporting DVD-ROM to DVD-ROM drive, and it should show the index page of Avalue's products automatically. If not, locate Index.htm and choose the product from the menu left, or link to `\\Driver_Chipset\Intel\ECM-BYT2`.



Note: The installation procedures and screen shots in this section are based on Windows 8.1 operation system. If the warning message appears while the installation process, click Continue to go on.

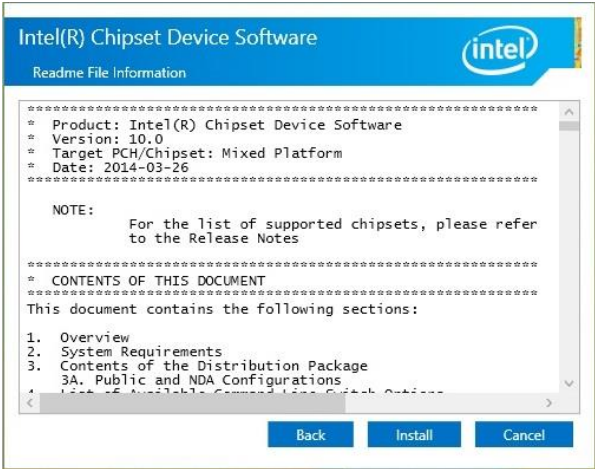

Step 3. Click **Install**.



Step1. Click **Next**.



Step 4. Click **Finish** to complete setup.



Step 2. Click **Accept**.

4.2 Install MBI Driver

Insert the Supporting DVD-ROM to DVD-ROM drive, and it should show the index page of Avalue's products automatically. If not, locate Index.htm and choose the product from the menu left, or link to \Utility\ECM-BYT2_MBI.



Note: The installation procedures and screen shots in this section are based on Windows 8.1 operation system. If the warning message appears while the installation process, click Continue to go on.

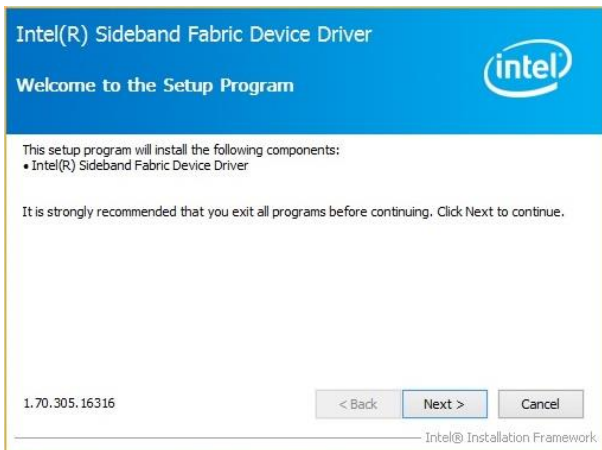

Step 1. Click **Next** to start installation.



Step 2. Click **Yes** to accept license agreement.

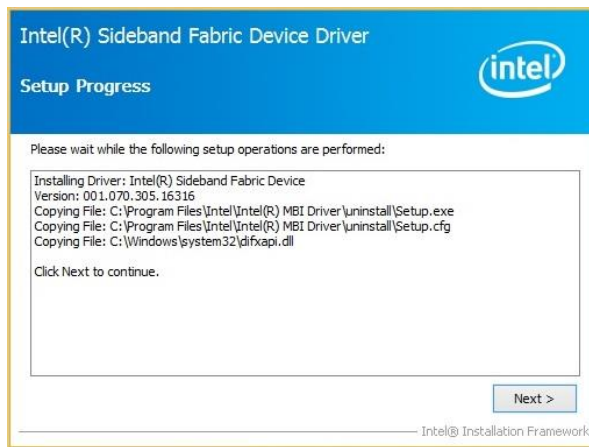

Step 3. Click **Next**.

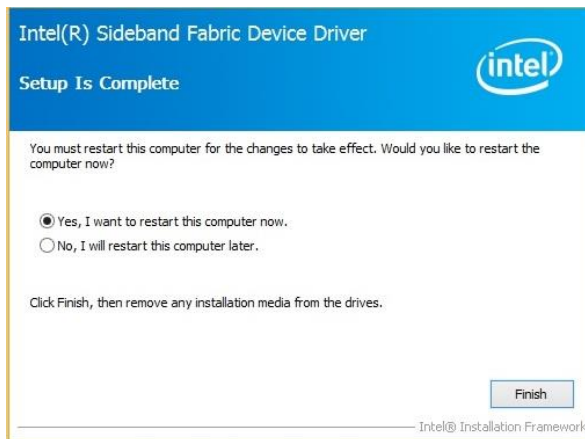

Step 4. Click **Finish** to complete setup.

4.3 Install TXE Driver

Insert the Supporting DVD-ROM to DVD-ROM drive, and it should show the index page of Avalue's products automatically. If not, locate Index.htm and choose the product from the menu left, or link to \Utility\ECM-BYT2_TXE.



Note: The installation procedures and screen shots in this section are based on Windows 8.1 operation system. If the warning message appears while the installation process, click Continue to go on.



Step 3. Click **Next** to continue installation.



Step1. Click **Next** to start installation.

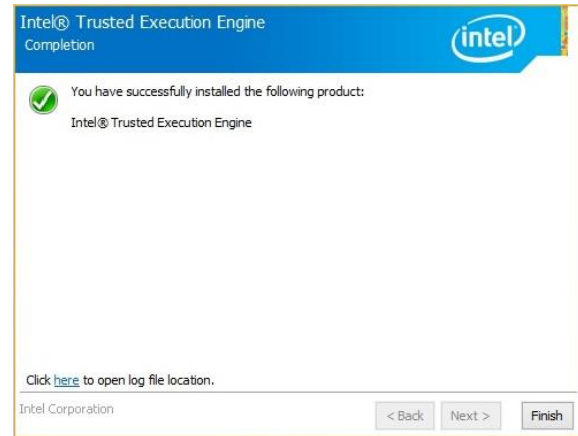

Step 4. Click **Finish** to complete setup.

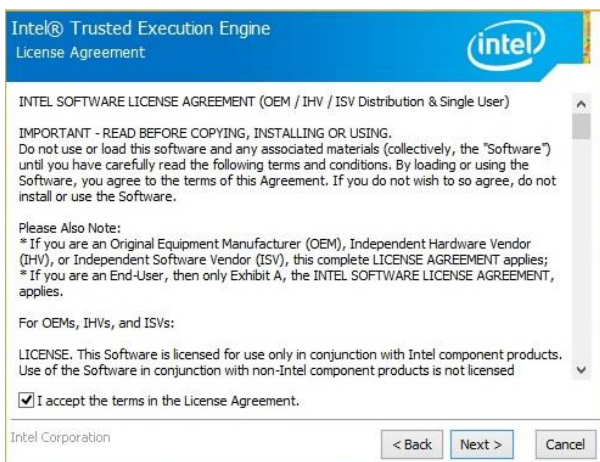

Step 2. Click **Next**.

4.4 Install VGA Driver

Insert the Supporting DVD-ROM to DVD-ROM drive, and it should show the index page of Avalue's products automatically. If not, locate Index.htm and choose the product from the menu left, or link to **VGA\ECM-BYT2**.



Note: The installation procedures and screen shots in this section are based on Windows 8.1 operation system.

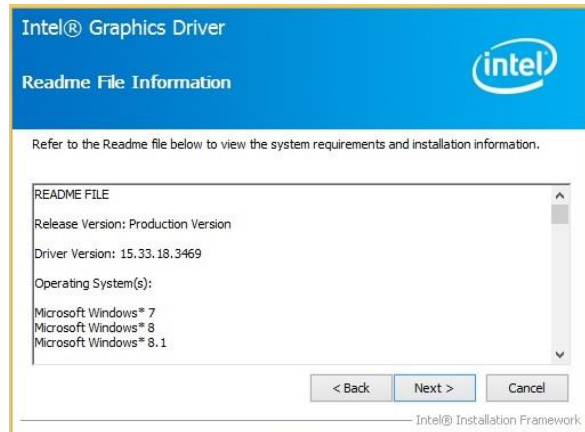

Step 3. Click Next.



Step 1. Click Next to continue installation.



Step 4. Click Next.



Step 2.
Click **Yes** to accept license agreement.

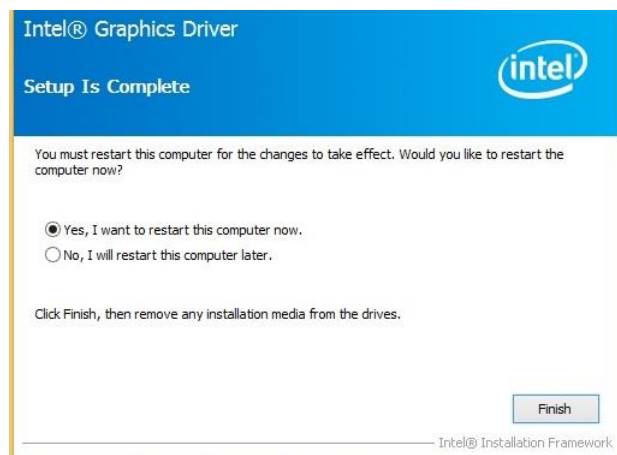

Step 5. Click Finish to complete setup.

4.5 Install Audio Driver (For Realtek ALC892)

Insert the Supporting CD-ROM to CD-ROM drive, and it should show the index page of Avalue's products automatically. If not, locate Index.htm and choose the product from the menu left, or link to **\\Driver_Audio\Realtek\ALC892\ECM-BYT2_Audio**.



Note: The installation procedures and screen shots in this section are based on Windows 8.1 operation system.

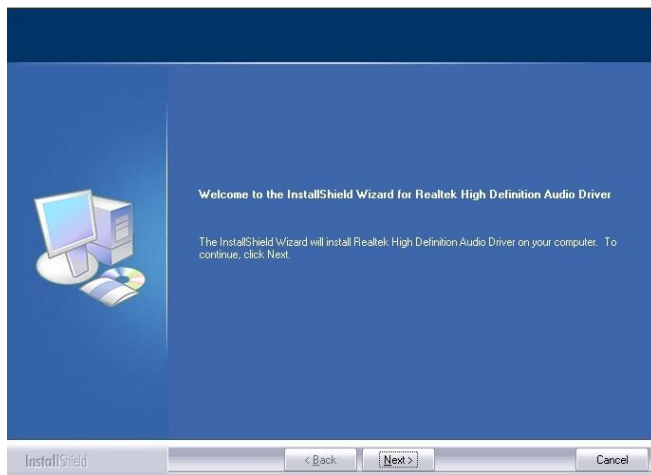

Step 1. Click **Next** to continue setup.

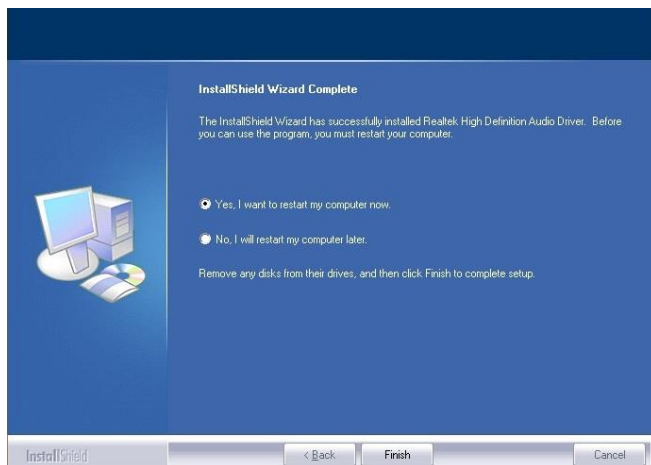

Step 2. Click **Finish** to complete the setup.

4.6 Install Ethernet Driver (For Realtek RTL8111E)

Insert the Supporting DVD-ROM to DVD-ROM drive, and it should show the index page of Avalue's products automatically. If not, locate Index.htm and choose the product from the menu left, or link to

\\Driver_Gigabit\Realtek\RTL8111E\ECM-BYT2_LAN.



Note: The installation procedures and screen shots in this section are based on Windows 8.1 operation system.

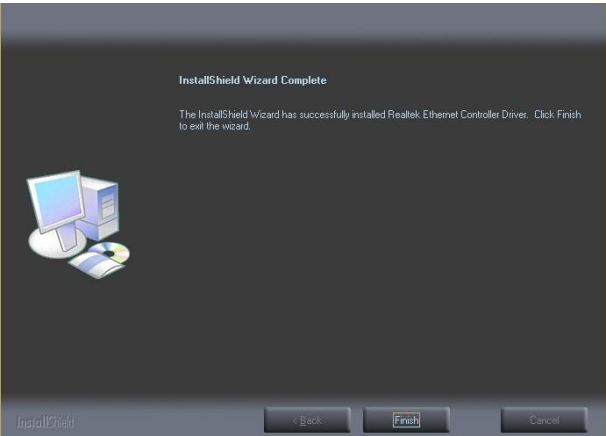

Step 3. Click **Finish** to complete the setup.

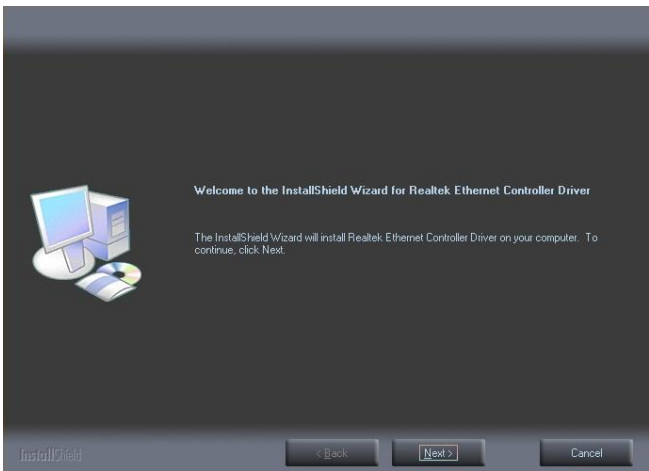

Step 1. Click **Next** to continue setup.

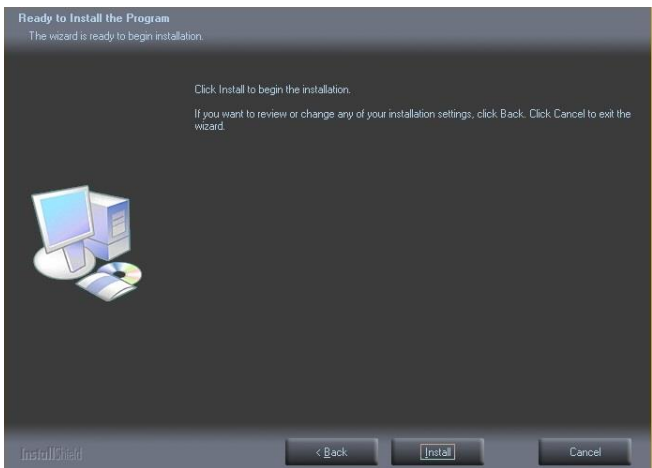

Step 2. Click **Install** to proceed.

4.7 Install Hub Driver

Insert the Supporting CD-ROM to CD-ROM drive, and it should show the index page of Avalue's products automatically. If not, locate Index.htm and choose the product from the menu left, or link to **Utility\ECM-BYT2_Hub**.



Note: The installation procedures and screen shots in this section are based on Windows 8.1 operation system.



Step 1. Click **Install** to continue setup.

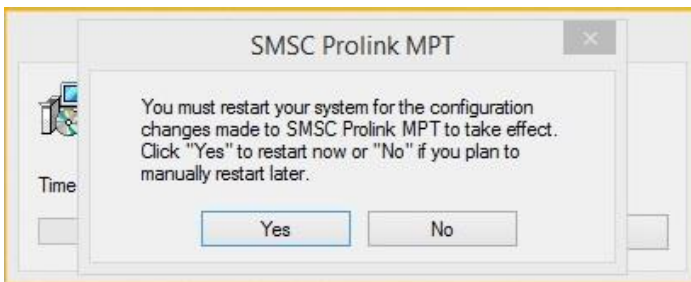

Step 2. Click **Yes** to accept license agreement.

5. Mechanical Drawing

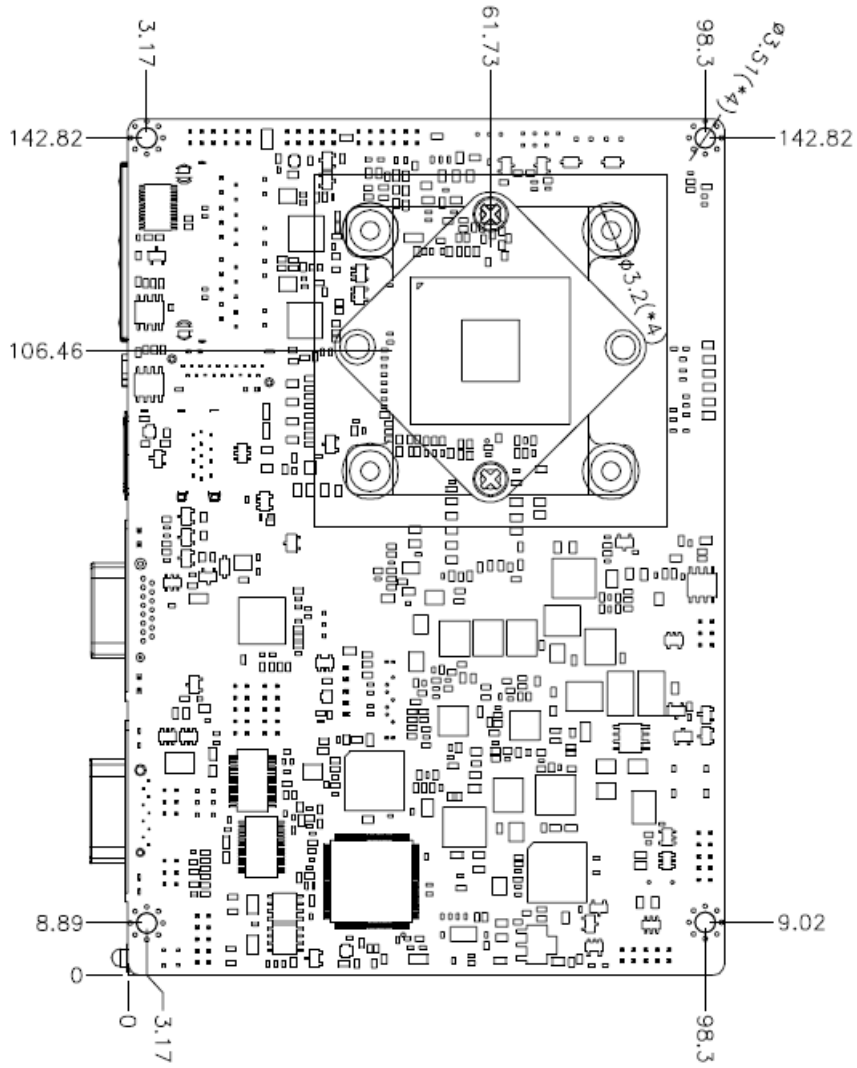

Unit: mm

