

# ECM-BSW

Intel® Pentium®/Celeron® Processor 3.5" Micro Module

## User's Manual

---

4<sup>th</sup> Ed – 06 October 2016

## FCC Statement



THIS DEVICE COMPLIES WITH PART 15 FCC RULES. OPERATION IS SUBJECT TO THE FOLLOWING TWO CONDITIONS:

- (1) THIS DEVICE MAY NOT CAUSE HARMFUL INTERFERENCE.
- (2) THIS DEVICE MUST ACCEPT ANY INTERFERENCE RECEIVED INCLUDING INTERFERENCE THAT MAY CAUSE UNDESIRE OPERATION.

THIS EQUIPMENT HAS BEEN TESTED AND FOUND TO COMPLY WITH THE LIMITS FOR A CLASS "A" DIGITAL DEVICE, PURSUANT TO PART 15 OF THE FCC RULES.

THESE LIMITS ARE DESIGNED TO PROVIDE REASONABLE PROTECTION AGAINST HARMFUL INTERFERENCE WHEN THE EQUIPMENT IS OPERATED IN A COMMERCIAL ENVIRONMENT. THIS EQUIPMENT GENERATES, USES, AND CAN RADIATE RADIO FREQUENCY ENERGY AND, IF NOT INSTALLED AND USED IN ACCORDANCE WITH THE INSTRUCTION MANUAL, MAY CAUSE HARMFUL INTERFERENCE TO RADIO COMMUNICATIONS.

OPERATION OF THIS EQUIPMENT IN A RESIDENTIAL AREA IS LIKELY TO CAUSE HARMFUL INTERFERENCE IN WHICH CASE THE USER WILL BE REQUIRED TO CORRECT THE INTERFERENCE AT HIS OWN EXPENSE.

## Notice

This guide is designed for experienced users to setup the system within the shortest time. For detailed information, please always refer to the electronic user's manual.

## Copyright Notice

Copyright © 2016 Avalue Technology Inc., ALL RIGHTS RESERVED.

No part of this document may be reproduced, copied, translated, or transmitted in any form or by any means, electronic or mechanical, for any purpose, without the prior written permission of the original manufacturer.

## Trademark Acknowledgement

Brand and product names are trademarks or registered trademarks of their respective owners.

## Disclaimer

Avalue Technology Inc. reserves the right to make changes, without notice, to any product, including circuits and/or software described or contained in this manual in order to improve design and/or performance. Avalue Technology assumes no responsibility or liability for the use of the described product(s), conveys no license or title under any patent, copyright, or masks work rights to these products, and makes no representations or warranties that

these products are free from patent, copyright, or mask work right infringement, unless otherwise specified. Applications that are described in this manual are for illustration purposes only. Avalue Technology Inc. makes no representation or warranty that such application will be suitable for the specified use without further testing or modification.

### Life Support Policy

Avalue Technology's PRODUCTS ARE NOT FOR USE AS CRITICAL COMPONENTS IN LIFE SUPPORT DEVICES OR SYSTEMS WITHOUT THE PRIOR WRITTEN APPROVAL OF Avalue Technology Inc.

As used herein:

1. Life support devices or systems are devices or systems which, (a) are intended for surgical implant into body, or (b) support or sustain life and whose failure to perform, when properly used in accordance with instructions for use provided in the labeling, can be reasonably expected to result in significant injury to the user.
2. A critical component is any component of a life support device or system whose failure to perform can be reasonably expected to cause the failure of the life support device or system, or to affect its safety or effectiveness.

### A Message to the Customer

#### *Avalue Customer Services*

Each and every Avalue's product is built to the most exacting specifications to ensure reliable performance in the harsh and demanding conditions typical of industrial environments. Whether your new Avalue device is destined for the laboratory or the factory floor, you can be assured that your product will provide the reliability and ease of operation for which the name Avalue has come to be known.

Your satisfaction is our primary concern. Here is a guide to Avalue's customer services. To ensure you get the full benefit of our services, please follow the instructions below carefully.

#### *Technical Support*

We want you to get the maximum performance from your products. So if you run into technical difficulties, we are here to help. For the most frequently asked questions, you can easily find answers in your product documentation. These answers are normally a lot more detailed than the ones we can give over the phone. So please consult the user's manual first.

To receive the latest version of the user's manual; please visit our Web site at:

<http://www.avalue.com.tw/>

## ECM-BSW User's Manual

### *Product Warranty*

Avalue warrants to you, the original purchaser, that each of its products will be free from defects in materials and workmanship for two years from the date of purchase.

This warranty does not apply to any products which have been repaired or altered by persons other than repair personnel authorized by Avalue, or which have been subject to misuse, abuse, accident or improper installation. Avalue assumes no liability under the terms of this warranty as a consequence of such events. Because of Avalue's high quality-control standards and rigorous testing, most of our customers never need to use our repair service. If any of Avalue's products is defective, it will be repaired or replaced at no charge during the warranty period. For out-of-warranty repairs, you will be billed according to the cost of replacement materials, service time, and freight. Please consult your dealer for more details. If you think you have a defective product, follow these steps:

1. Collect all the information about the problem encountered. (For example, CPU type and speed, Avalue's products model name, hardware & BIOS revision number, other hardware and software used, etc.) Note anything abnormal and list any on-screen messages you get when the problem occurs.
2. Call your dealer and describe the problem. Please have your manual, product, and any helpful information available.
3. If your product is diagnosed as defective, obtain an RMA (return material authorization) number from your dealer. This allows us to process your good return more quickly.
4. Carefully pack the defective product, a complete Repair and Replacement Order Card and a photocopy proof of purchase date (such as your sales receipt) in a shippable container. A product returned without proof of the purchase date is not eligible for warranty service.
5. Write the RMA number visibly on the outside of the package and ship it prepaid to your dealer.

# Content

<b>1. Getting Started</b> .....	<b>8</b>
1.1 Safety Precautions.....	8
1.2 Packing List.....	8
1.3 Document Amendment History .....	9
1.4 Manual Objectives.....	10
1.5 System Specifications .....	11
1.6 Architecture Overview—Block Diagram .....	13
<b>2. Hardware Configuration</b> .....	<b>14</b>
2.1 Product Overview.....	15
2.2 Jumper and Connector List.....	17
2.3 Setting Jumpers & Connectors .....	19
2.3.1 AT/ ATX Input power select (JAT1).....	19
2.3.2 Serial port 1 pin9 signal select (JRI1) .....	19
2.3.3 Clear CMOS (JBAT1).....	20
2.3.4 LCD backlight brightness adjustment (JBKL_SEL1).....	20
2.3.5 LCD Inverter connector (JBKL1) .....	21
2.3.6 LCD Backlight VR/Push Up/Push Down header (JBLKCTL).....	21
2.3.7 CPU fan connector (CPU_FAN1).....	22
2.3.8 Serial port 1 connector (COM1) .....	22
2.3.9 Serial port 2 connector (JCOM2) .....	23
2.3.10 Serial port 3/4/5 connector (JCOM3/JCOM4/JCOM5) .....	23
2.3.11 General purpose I/O connector (JDIO1).....	24
2.3.12 Touch panel connector (JTOUCH1) .....	24
2.3.13 SATA Power header (SATA_PWR1).....	25
2.3.14 Power connector (PWR1) .....	25
2.3.15 LVDS connector (JLVDS) .....	26
2.3.16 On-board header for USB2.0 (H_USB1).....	27
2.3.17 EC Debug connector (JECDEBUG).....	27
2.3.18 PS/2 keyboard & mouse header (JKBMS1) .....	28
2.3.19 Serial port 1 in RS-422/485 mode (J422_485) .....	28
2.3.20 Miscellaneous setting connector (JFP1).....	29
2.3.21 BIOS SPI header (BIOS_SPI1).....	29
2.3.22 PC Buzzer header (JBZ1).....	30
2.3.23 Battery connector (BT1).....	30
2.3.24 Audio connector (JAUDIO1) .....	31
2.3.24.1 Signal Description – Audio connector (JAUDIO1).....	31

## ECM-BSW User's Manual

2.3.25	VGA header (JVGA1) .....	32
2.3.26	LPC connector (JLPC1) .....	32
<b>3. BIOS Setup .....</b>		<b>33</b>
3.1	Introduction .....	34
3.2	Starting Setup .....	34
3.3	Using Setup .....	35
3.4	Getting Help .....	36
3.5	In Case of Problems .....	36
3.6	BIOS setup .....	37
3.6.1	Main Menu .....	37
3.6.1.1	System Time .....	37
3.6.1.2	System Date .....	37
3.6.2	Advanced Menu .....	38
3.6.2.1	SATA Configuration .....	39
3.6.2.2	PCI Express Configuration .....	39
3.6.2.3	RTC S5 Wake .....	40
3.6.2.4	Hardware Monitor .....	41
3.6.2.5	SIO NUVOTON5104D .....	41
3.6.2.6	Brightness Control .....	42
3.6.2.7	Device function Control .....	43
3.6.3	Security .....	43
3.6.4	Power .....	44
3.6.5	Boot .....	45
3.6.6	Exit .....	46
3.6.6.1	Exit Saving Changes .....	46
3.6.6.2	Save Change Without Exit .....	46
3.6.6.3	Exit Discarding Changes .....	46
3.6.6.4	Load Optimal Defaults .....	46
3.6.6.5	Load Custom Defaults .....	46
3.6.6.6	Save Custom Defaults .....	46
3.6.6.7	Discard Changes .....	46
<b>4. Drivers Installation .....</b>		<b>47</b>
4.1	Install Chipset Driver .....	48
4.2	Install Nuvoton Driver .....	49
4.3	Install TXE Driver .....	50
4.4	Install VGA Driver .....	51
4.5	Install Audio Driver (For Realtek ALC233) .....	52
4.6	Install USB3.0 Driver .....	53
4.7	Install Ethernet Driver .....	54
4.8	Install Serial IO Driver .....	55

4.9	Install SMSC Hub Driver .....	56
4.10	Install Touch Driver .....	57
<b>5.</b>	<b>Mechanical Drawing .....</b>	<b>59</b>

# 1. Getting Started

## 1.1 Safety Precautions

### Warning!



Always completely disconnect the power cord from your chassis whenever you work with the hardware. Do not make connections while the power is on. Sensitive electronic components can be damaged by sudden power surges. Only experienced electronics personnel should open the PC chassis.

### Caution!



Always ground yourself to remove any static charge before touching the CPU card. Modern electronic devices are very sensitive to static electric charges. As a safety precaution, use a grounding wrist strap at all times. Place all electronic components in a static-dissipative surface or static-shielded bag when they are not in the chassis.

## 1.2 Packing List

Before you begin installing your single board, please make sure that the following materials have been shipped:

- 1 x 3.5" ECM-BSW Micro Module
- 1 x DVD-ROM contains the followings:
  - User's Manual (this manual in PDF file)
  - Ethernet driver and utilities
  - VGA drivers and utilities
  - Audio drivers and utilities
- 1 x Cable set contains the followings:
  - 1 x Serial ATA cable (7-pin, standard)
  - 1 x Wire SATA power cable (15-pin, 2P/2.0mm)
  - 1 x Flat Cable 9P(M)-PHD (10P/2.0mm)
- 3M foam (VHB-4622 10mm\*20mm\*1.1mm)



---

If any of the above items is damaged or missing, contact your retailer.

---



### 1.3 Document Amendment History

Revision	Date	By	Comment
1 <sup>st</sup>	August 2015	Avalue	Initial Release
2 <sup>nd</sup>	March 2016	Avalue	Update JFP1 Pin Signal
3 <sup>rd</sup>	September 2016	Avalue	Update 2.3.4 JBKL_SEL1/ 2.3.6 JBLKCTL
4 <sup>th</sup>	October 2016	Avalue	Increase 2.3.8 Serial port 1 connector (COM1)

### 1.4 Manual Objectives

This manual describes in details Avalue Technology ECM-BSW Single Board.

We have tried to include as much information as possible but we have not duplicated information that is provided in the standard IBM Technical References, unless it proved to be necessary to aid in the understanding of this board.

We strongly recommend that you study this manual carefully before attempting to set up ECM-BSW or change the standard configurations. Whilst all the necessary information is available in this manual we would recommend that unless you are confident, you contact your supplier for guidance.

Please be aware that it is possible to create configurations within the CMOS RAM that make booting impossible. If this should happen, clear the CMOS settings, (see the description of the Jumper Settings for details).

If you have any suggestions or find any errors regarding this manual and want to inform us of these, please contact our Customer Service department with the relevant details.

## 1.5 System Specifications

<b>System</b>	
<b>CPU</b>	Intel® Pentium®/Celeron® processor N3000 series for mobile
<b>BIOS</b>	Insyde BIOS, 64 Mbit SPI Flash ROM
<b>System Chipset</b>	Braswell SoC integrated
<b>I/O Chip</b>	Nuvoton NPCE388N
<b>System Memory</b>	1 x 204-pin DDR3L 1600 SODIMM up to 8G (non ECC) (If 1333 MHz DIMM is installed, it will run at 1066 MHz)
<b>SSD</b>	mSATA (from MiniPCIe)
<b>Watchdog Timer</b>	H/W Reset, 1sec. ~ 65535sec and 1sec. or 1min./step
<b>H/W Status Monitor</b>	CPU & system temperature monitoring Voltages monitoring
<b>Expansion</b>	1 x Full-Size Mini PCI Express Mini Card with mSATA supported 1 x Half-size Mini PCIe
<b>Built-in Touch screen (optional)</b>	EETI ETP-CP-MER4485XRU With 5-pin 2.0mm Box Header (Can be Selected to Support 4/ 5Wire Touch Screen)
<b>I/O</b>	
<b>MIO</b>	1 x SATA III 1 x DB-9 male connector for COM1 supports RS232/422/485 (selectable by BIOS, w/ Auto Flow)
<b>USB</b>	4 x USB3.0 (Edge connectors), 2 x USB 2.0 (Pin header)
<b>GPIO</b>	8-bit
<b>Others</b>	LPC, SPI
<b>Display</b>	
<b>Chipset</b>	Braswell SoC integrated Graphics
<b>Resolution</b>	HDMI mode: 1920x1080@60Hz LVDS mode:1920x1080@60Hz VGA by pin header (optional)
<b>Multiple Display</b>	HDMI + LVDS
<b>HDMI</b>	HDMI x1.4b
<b>LCD Interface</b>	Dual channel 18/24-bit LVDS LVDS via Realtek RTD2136N
<b>Audio</b>	
<b>AC97 Codec</b>	Realtek ALC233 HD Audio support 2.1-CH
<b>Audio Amp</b>	2W
<b>Ethernet</b>	

## ECM-BSW User's Manual

<b>LAN Chip</b>	2 x RealTek RTL8119I
<b>Ethernet Interface</b>	10/100/1000 Base-Tx compatible
<b>Internal I/O Connectors</b>	
<b>Fan</b>	CPU_FAN1 4pin 2.5mm wafer header
<b>Buzzer</b>	With Pin header
<b>CMOS Battery</b>	CR2032
<b>Power On</b>	AX / ATX selectable by jumper
<b>Audio</b>	8 x 2 pin header w/2.0mm pitch With AMP_L+/-, AMP_R+/-
<b>COM</b>	4 x RS232 (Pin header) for COM2/3/4/5
<b>Rear I/O Connectors</b>	
<b>USB</b>	4 x USB3.0
<b>LAN</b>	2 x RJ-45
<b>HDMI</b>	1 x HDMI (HDMI 19P 90D(F) STD w/Flange BLK)
<b>LED</b>	Stack LED indicator for power / HDD
<b>Mechanical &amp; Environmental</b>	
<b>Power Requirement</b>	+11.4V ~ +26V
<b>ACPI</b>	Single power ATX Support S0, S3, S4, S5 ACPI 5.0 Compliant
<b>Power Type</b>	AT / ATX
<b>Operating Temp.</b>	0°C ~ 60°C
<b>Storage Temp.</b>	-40°C ~ 75°C
<b>Operating Humidity</b>	0% ~ 90% relative humidity, non-condensing
<b>Size (L x W)</b>	5.7" x 4" (146mm x 101mm)
<b>Weight</b>	0.44lbs (0.2kg)
<b>OS support</b>	Windows 10/ 8.1 / Windows 7 / Linux



**Note:** Specifications are subject to change without notice.

## 1.6 Architecture Overview—Block Diagram

The following block diagram shows the architecture and main components of ECM-BSW.

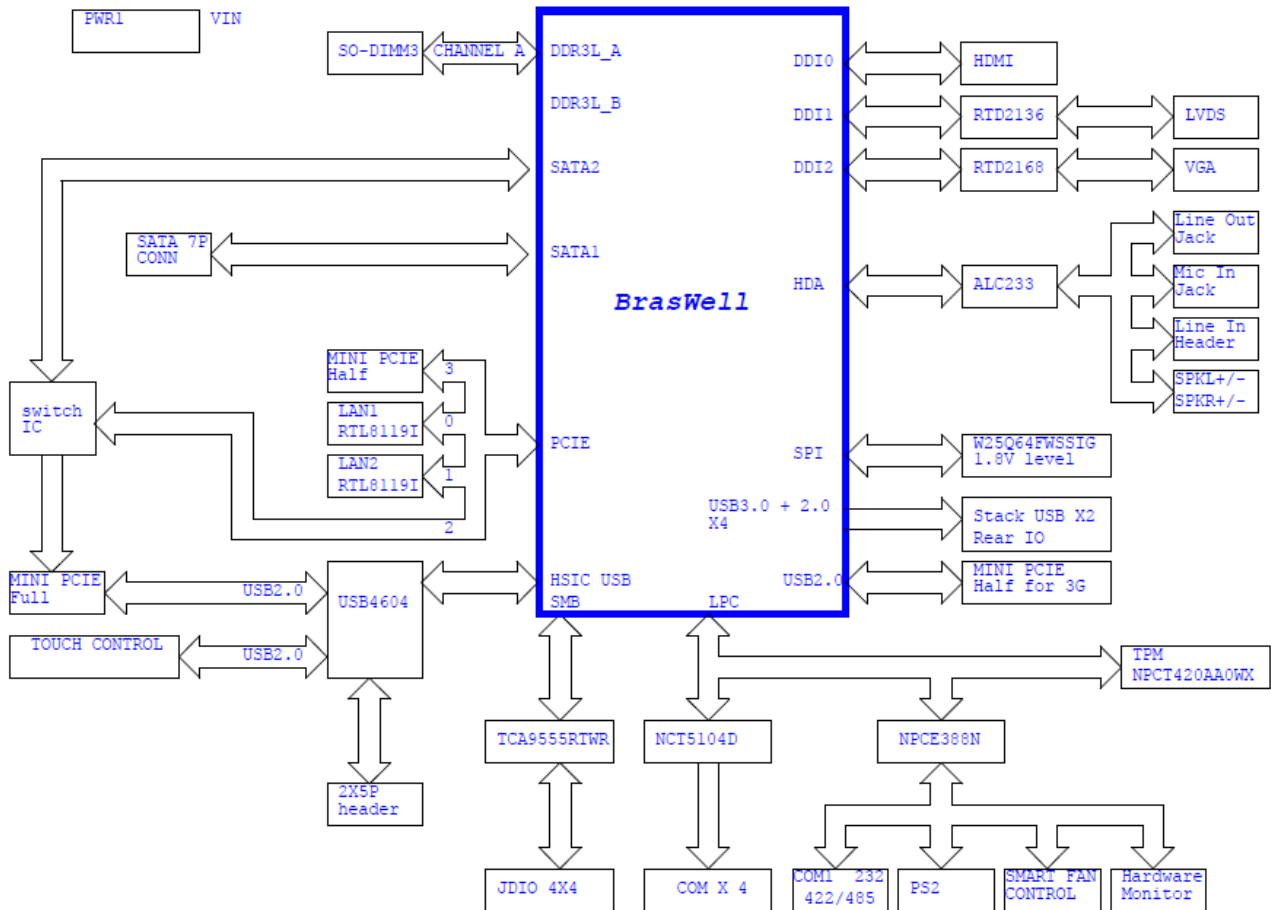

# 2. Hardware Configuration

---

## 2.1 Product Overview

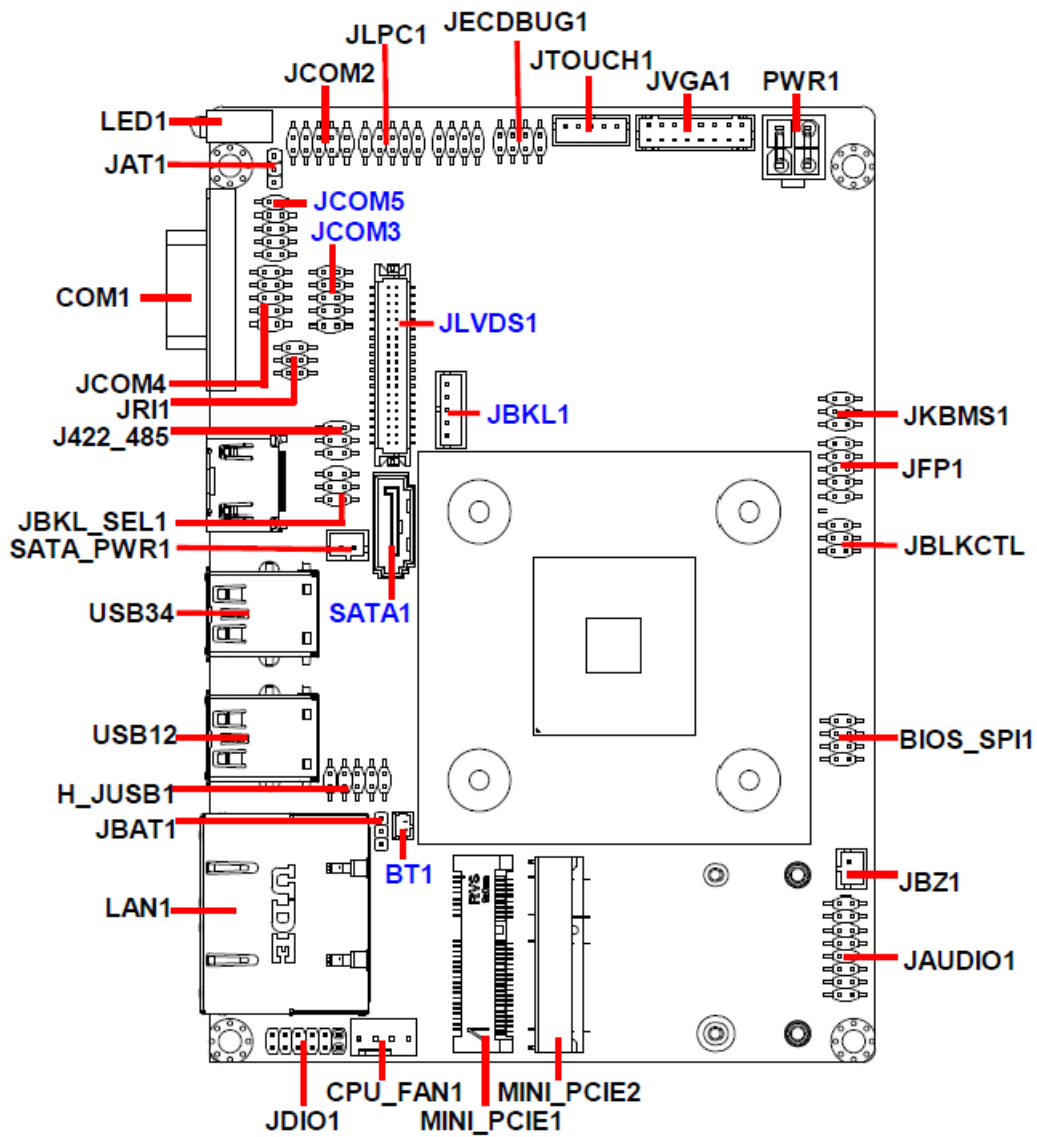

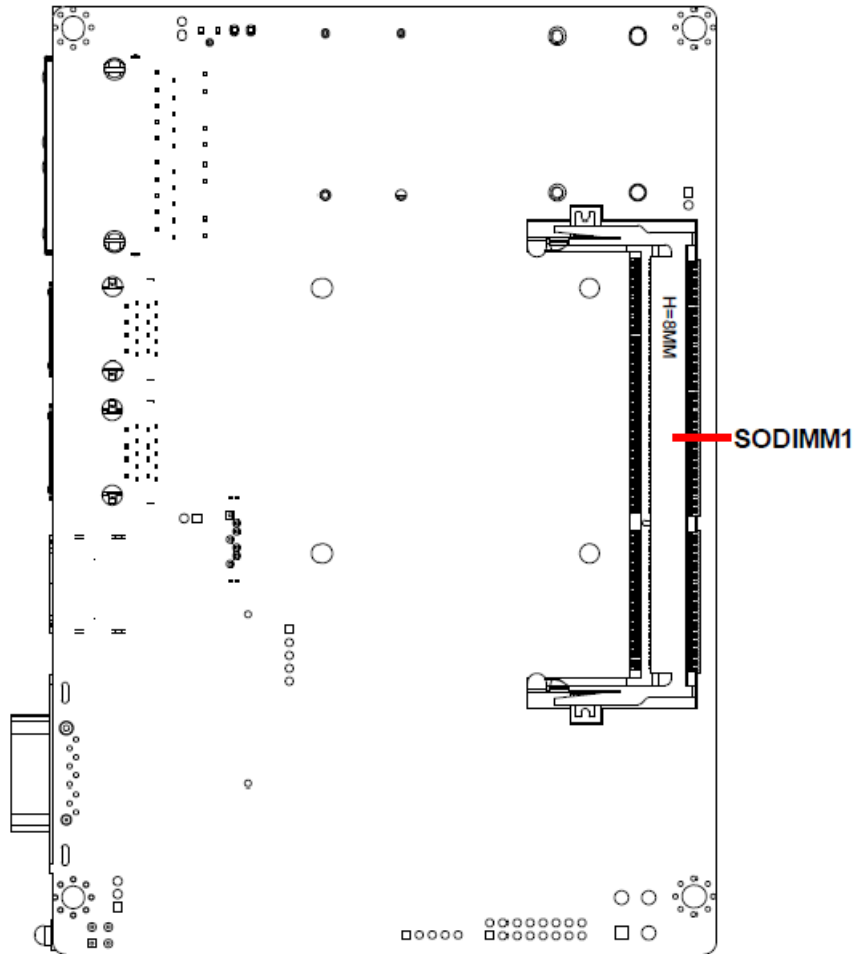



## 2.2 Jumper and Connector List

You can configure your board to match the needs of your application by setting jumpers. A jumper is the simplest kind of electric switch.

It consists of two metal pins and a small metal clip (often protected by a plastic cover) that slides over the pins to connect them. To “close” a jumper you connect the pins with the clip. To “open” a jumper you remove the clip. Sometimes a jumper will have three pins, labeled 1, 2, and 3. In this case, you would connect either two pins.

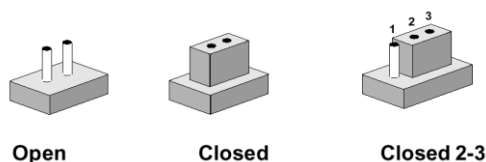

The jumper settings are schematically depicted in this manual as follows:



A pair of needle-nose pliers may be helpful when working with jumpers.

Connectors on the board are linked to external devices such as hard disk drives, a keyboard, or floppy drives. In addition, the board has a number of jumpers that allow you to configure your system to suit your application.

If you have any doubts about the best hardware configuration for your application, contact your local distributor or sales representative before you make any changes.

The following tables list the function of each of the board's jumpers and connectors.

### Jumpers

Label	Function	Note
<b>JBAT1</b>	Clear CMOS	3 x 1 header, pitch 2.00 mm
<b>JRI1</b>	Serial port 1 pin9 signal select	3 x 2 header, pitch 2.00 mm
<b>JAT1</b>	AT/ ATX Input power select	3 x 1 header, pitch 2.00 mm
<b>JBKL_SEL1</b>	LCD backlight brightness adjustment	3 x 2 header, pitch 2.00 mm

### Connectors

Label	Function	Note
<b>BT1</b>	Battery connector	2 x 1 wafer, pitch 1.25 mm
<b>CPU_FAN1</b>	CPU fan connector	4 x 1 wafer, pitch 2.54 mm
<b>JAUDIO1</b>	Audio connector	8 x 2 header, pitch 2.00 mm
<b>JBKL1</b>	LCD inverter connector	5 x 1 wafer, pitch 2.00 mm

## ECM-BSW User's Manual

<b>J422_485</b>	Serial port 1 in RS-422/485 mode	3 x 2 header, pitch 2.00 mm
		D-sub 9-pin, male (Only for RS232)
<b>COM1</b>	Serial port 1 connector	<b>Note</b> : COM1 support RS422/485 by BIOS setting & extended cable is required when connect on board header of "J422_485".
<b>JCOM2/3/4/5</b>	Serial port 2/3/4/5 connector	5 x 2 header, pitch 2.00 mm
<b>JDIO1</b>	General purpose I/O connector	6 x 2 header, pitch 2.00 mm
<b>JFP1</b>	Miscellaneous setting connector	5 x 2 header, pitch 2.00 mm
<b>JLPC1</b>	Low pin count interface	5 x 2 header, pitch 2.00 mm
<b>JLVDS1</b>	LVDS connector	20 x 2 header, pitch 1.25 mm
<b>JTOUCH1</b>	Touch Panel connector	5 x 1 wafer, pitch 2.00 mm
<b>USB12/34</b>	On-board connector for USB3.0 x 4	
<b>H_JUSB1</b>	On-board header for USB2.0	5 x 2 header, pitch 2.00 mm
<b>JECDEBUG1</b>	EC Debug connector	4 x 2 header, pitch 2.00 mm
<b>LAN1</b>	RJ-45 Ethernet connector x 2	
<b>LED1</b>	HDD/Power LED indicator	
<b>PWR1</b>	Power connector	2 x 2 wafer, pitch 4.20 mm
<b>JKBMS1</b>	PS/2 keyboard & mouse header	3 x 2 header, pitch 2.00 mm
<b>SATA_PWR1</b>	SATA power header	2 x 1 wafer, pitch 2.00 mm
<b>SATA1</b>	Serial ATA connector 1	
<b>JVGA1</b>	VGA header (optional)	8 x 2 wafer, pitch 2.00 mm
<b>BIOS_SPI1</b>	BIOS SPI header	4 x 2 header, pitch 2.00 mm
<b>MINI_PCIE1/2</b>	Mini-PCI connector 1/2	
<b>SO_DIMM1</b>	DDR3 SODIMM connector	
<b>JBZ1</b>	PC Buzzer header	2 x 1 wafer, pitch 2.00 mm
<b>JBLKCTL</b>	LCD Backlight VR/Push Up/Push Down header	3 x 2 header, pitch 2.00mm

## 2.3 Setting Jumpers & Connectors

### 2.3.1 AT/ ATX Input power select (JAT1)

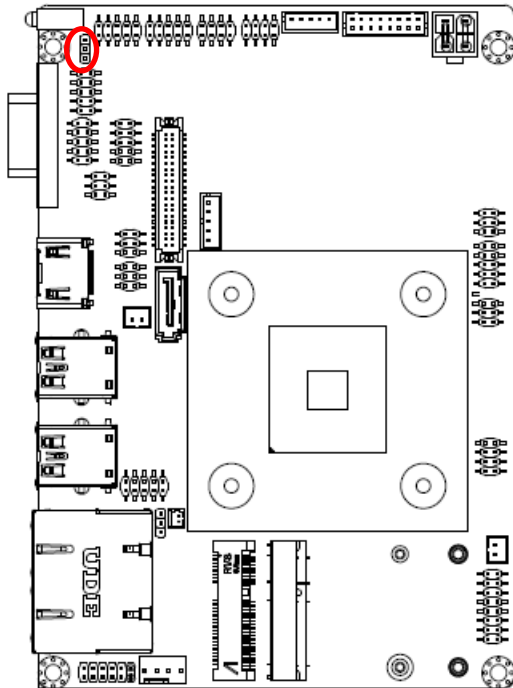

AT\*

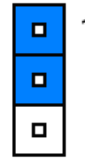

ATX

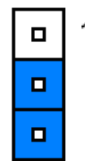

### 2.3.2 Serial port 1 pin9 signal select (JRI1)

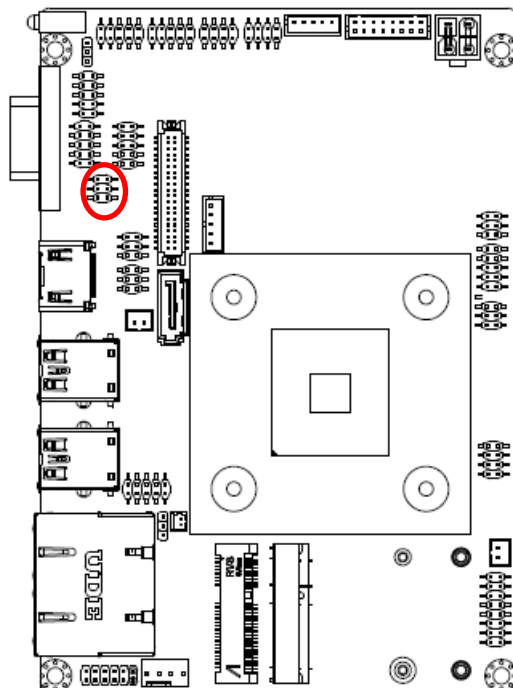

Ring\*

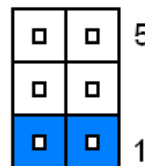

+5V

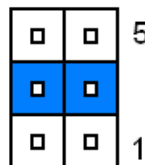

+12V

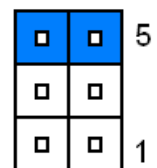

\* Default

2.3.3 Clear CMOS (JBAT1)

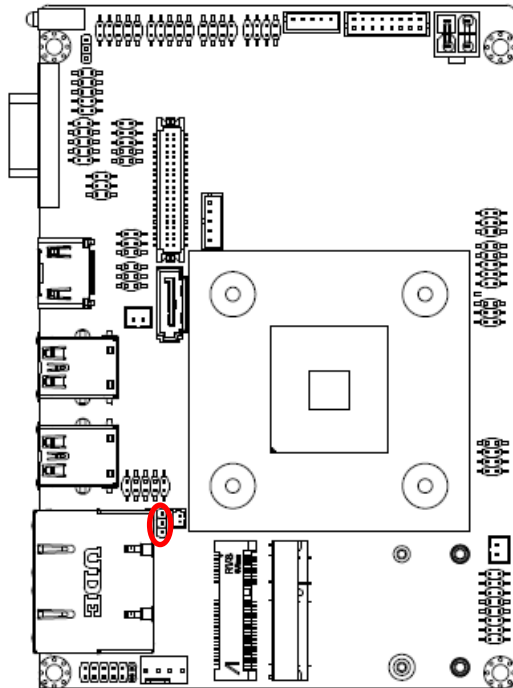

Protect\*

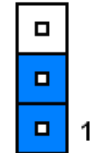

Clear CMOS

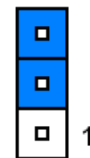

\* Default

2.3.4 LCD backlight brightness adjustment (JBKL\_SEL1)

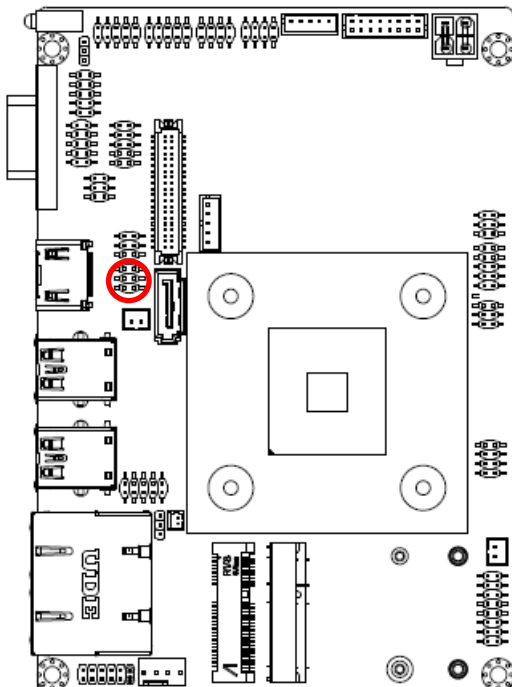

PWM Mode\*

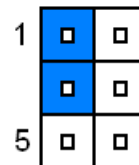

OS Driver Control

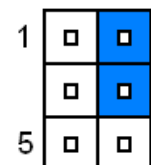

DC Mode

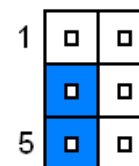

VR Control\*

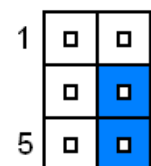

\* Default

JBKL_SEL1		
Type	PWM	1-3
	DC	3-5
Level	OS Driver Control	2-4
	VR	4-6

For OS Driver Control, Brightness Control in the BIOS setting must set "VR".

### 2.3.5 LCD Inverter connector (JBKL1)

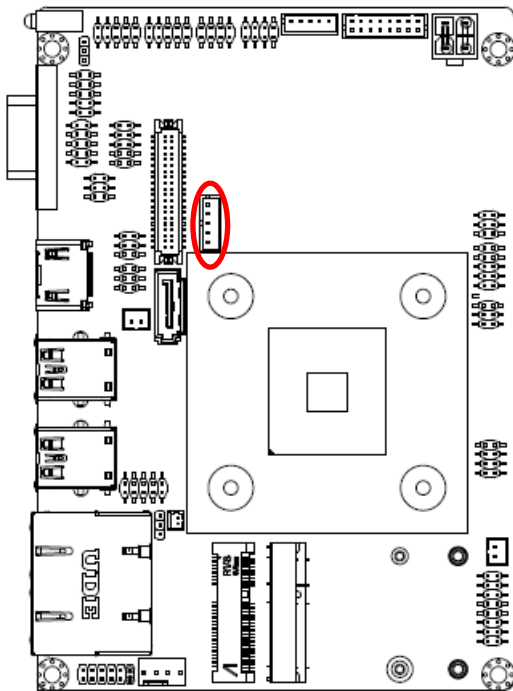

Signal	PIN
+5V	5
VBRIGHT	4
BKLEN	3
GND	2
+12V	1

**Note:**



For inverters with adjustable Backlight function, it is possible to control the LCD brightness through the VR signal controlled by **JBLKCTL**. Please see the **JBLKCTL** section for detailed circuitry information.

### 2.3.6 LCD Backlight VR/Push Up/Push Down header (JBLKCTL)

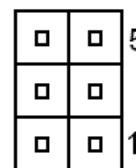
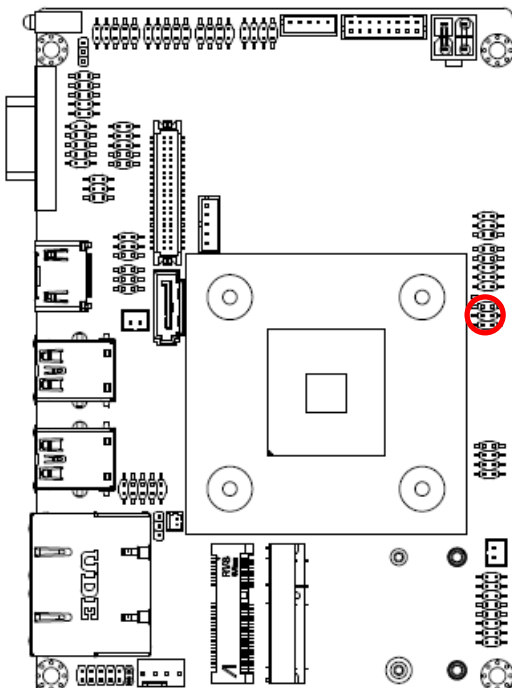

Signal	PIN	PIN	Signal
GND	6	5	BLK_BRI_DN
GND	4	3	BLK_BRI_UP
GND	2	1	BLK_VR_MOD

**Note:**



For Button down/up control (BLK\_BRI\_DN/ BLK\_BRI\_UP), Brightness Control in the BIOS setting must set "BIOS".

2.3.7 CPU fan connector (CPU\_FAN1)

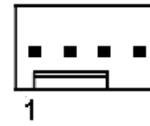
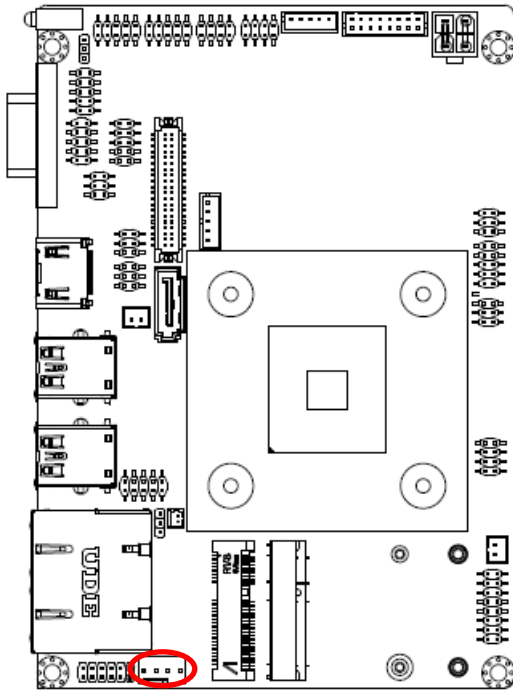

Signal	PIN
GND	1
+12V	2
EC_TACH0	3
FAN_PWM1	4

2.3.8 Serial port 1 connector (COM1)

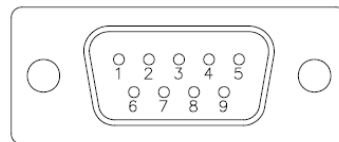
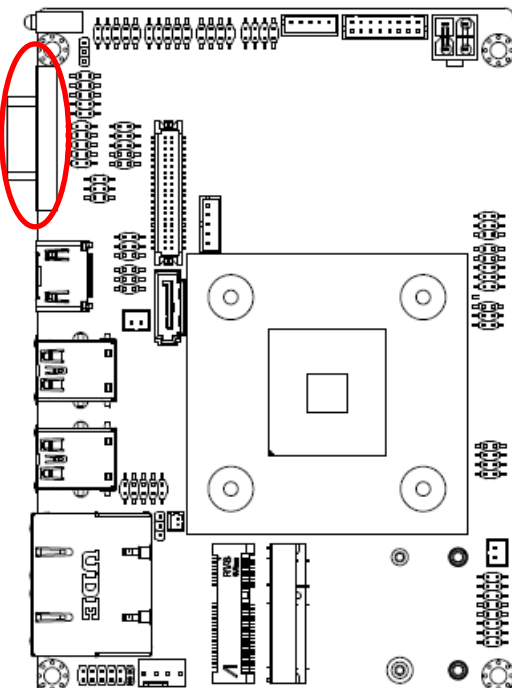

Signal	PIN	PIN	Signal
DCD#	1	6	DSR#
RXD	2	7	RTS#
TXD	3	8	CTS#
DTR#	4	9	RI#
GND	5		

### 2.3.9 Serial port 2 connector (JCOM2)

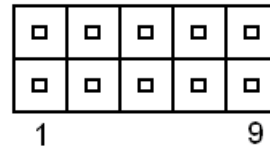
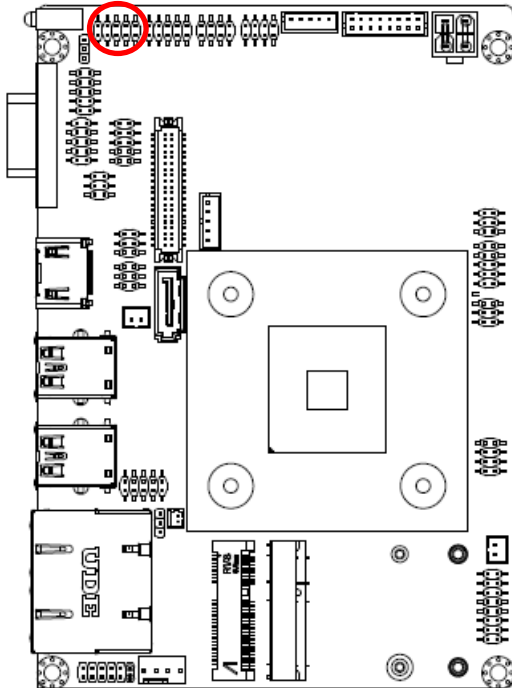

Signal	PIN	PIN	Signal
COM_RXD#	2	1	COM_DCD#
COM_DTR#	4	3	COM_TXD
COM_DSR#	6	5	GND
COM_CTS#	8	7	COM_RTS#
NC	10	9	COM_RI#

### 2.3.10 Serial port 3/4/5 connector (JCOM3/JCOM4/JCOM5)

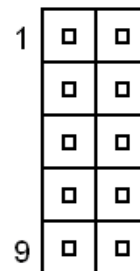
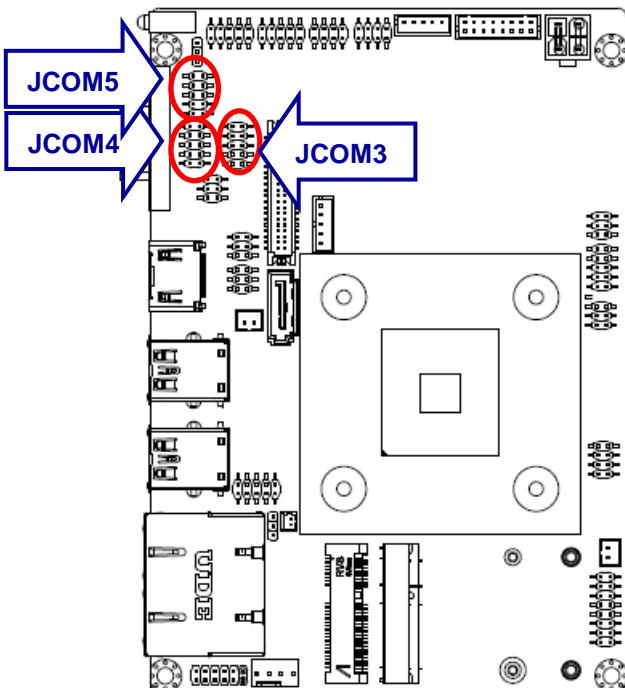

Signal	PIN	PIN	Signal
COM_DCD#	1	2	COM_RXD#
COM_TXD	3	4	COM_DTR#
GND	5	6	COM_DSR#
COM_RTS#	7	8	COM_CTS#
COM_RI#	9	10	NC

2.3.11 General purpose I/O connector (JDIO1)

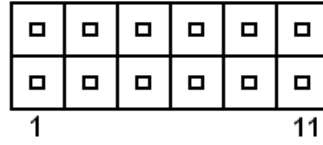
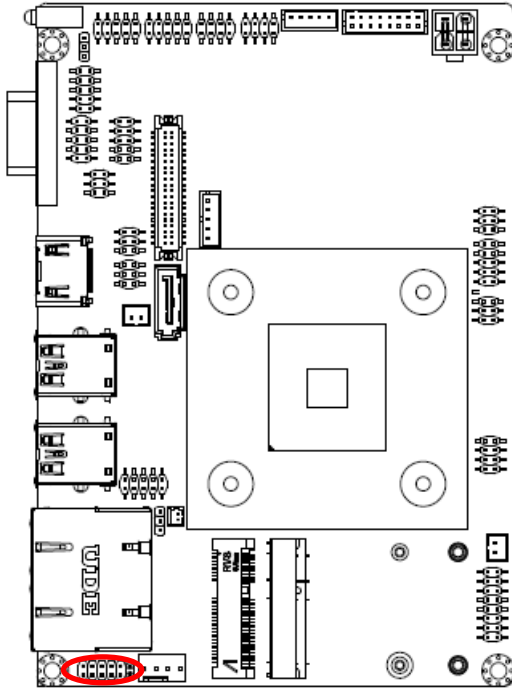

Signal	PIN	PIN	Signal
DIO_GP20	1	2	DIO_GP10
DIO_GP21	3	4	DIO_GP11
DIO_GP22	5	6	DIO_GP12
DIO_GP23	7	8	DIO_GP13
SMB_CLK_9555	9	10	SMB_DATA_9555
GND	11	12	+5V

2.3.12 Touch panel connector (JTOUCH1)

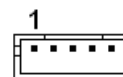
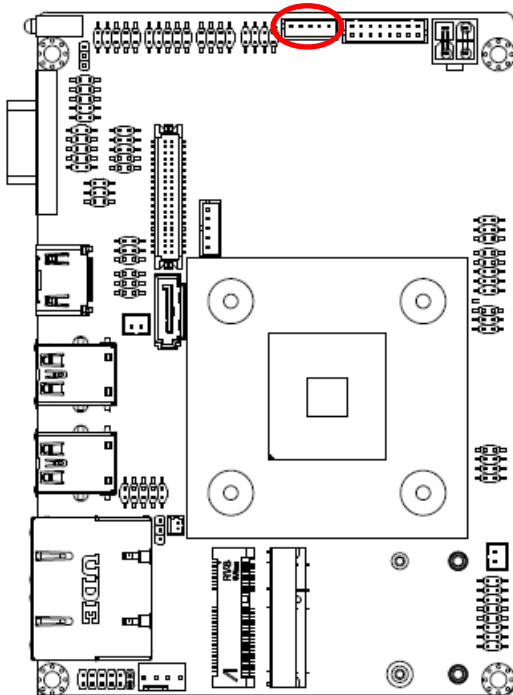

Signal	PIN
THX+	1
THX-	2
THPROBE_R	3
THY+	4
THY-	5



### 2.3.13 SATA Power header (SATA\_PWR1)

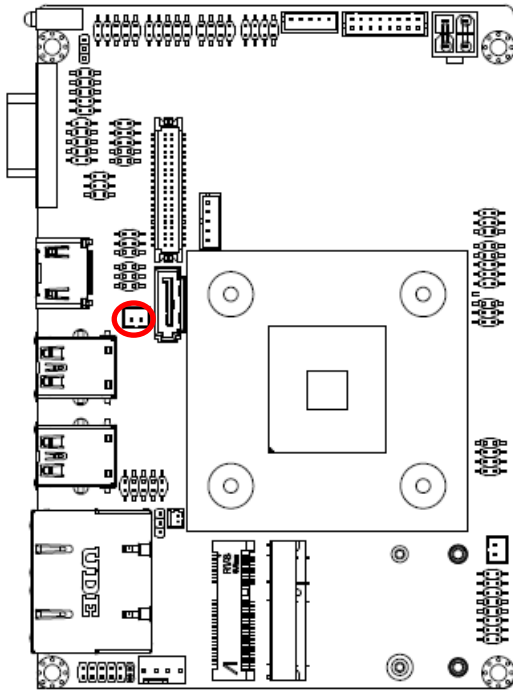

Signal	PIN
GND	1
+5V	2

### 2.3.14 Power connector (PWR1)

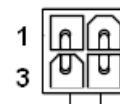
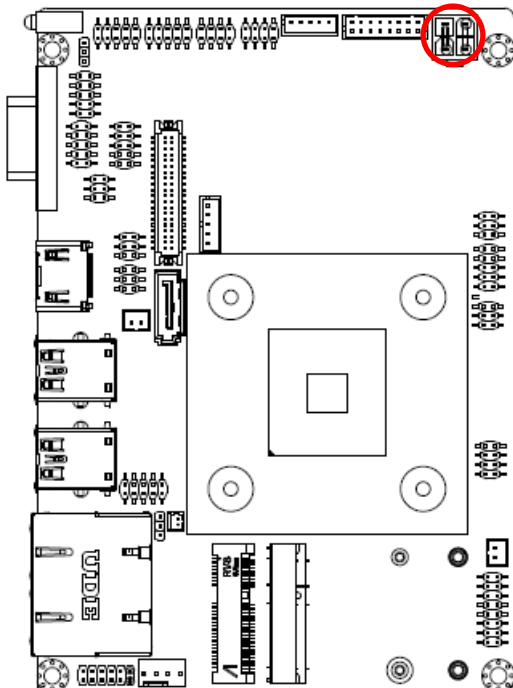

Signal	PIN	PIN	Signal
GND	1	2	GND
+26V	3	4	+26V

2.3.15 LVDS connector (JLVDS)

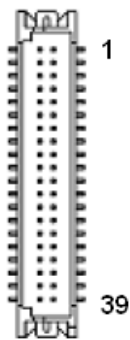
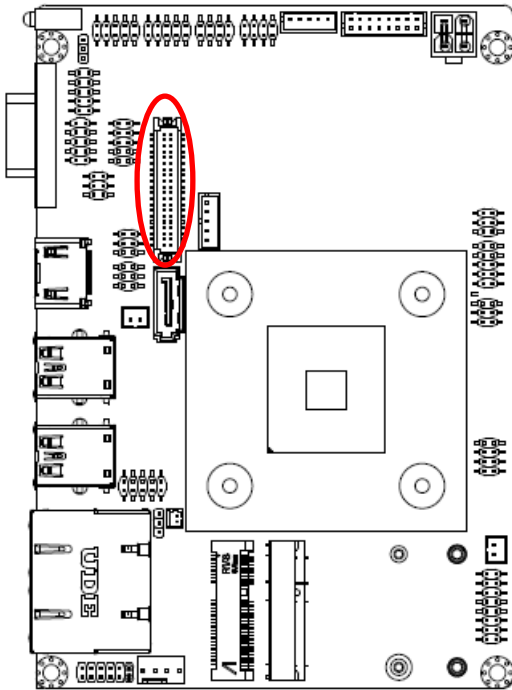

Signal	PIN	PIN	Signal
+5V	2	1	+3.3V
+5V	4	3	+3.3V
PANEL_DDC_DAT	6	5	PANEL_DDC_CLK
GND	8	7	GND
LVDS_DATA0_P	10	9	LVDS_DATA1_P
LVDS_DATA0_N	12	11	LVDS_DATA1_N
GND	14	13	GND
LVDS_DATA2_P	16	15	LVDS_DATA3_P
LVDS_DATA2_N	18	17	LVDS_DATA3_N
GND	20	19	GND
LVDS_DATA4_P	22	21	LVDS_DATA5_P
LVDS_DATA4_N	24	23	LVDS_DATA5_N
GND	26	25	GND
LVDS_DATA6_P	28	27	LVDS_DATA7_P
LVDS_DATA6_N	30	29	LVDS_DATA7_N
GND	32	31	GND
LVDS_CLK1_P	34	33	LVDS_CLK2_P
LVDS_CLK1_N	36	35	LVDS_CLK2_N
GND	38	37	GND
+12V	40	39	+12V

### 2.3.16 On-board header for USB2.0 (H\_JUSB1)

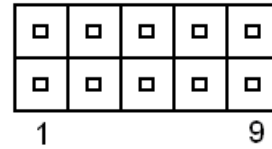
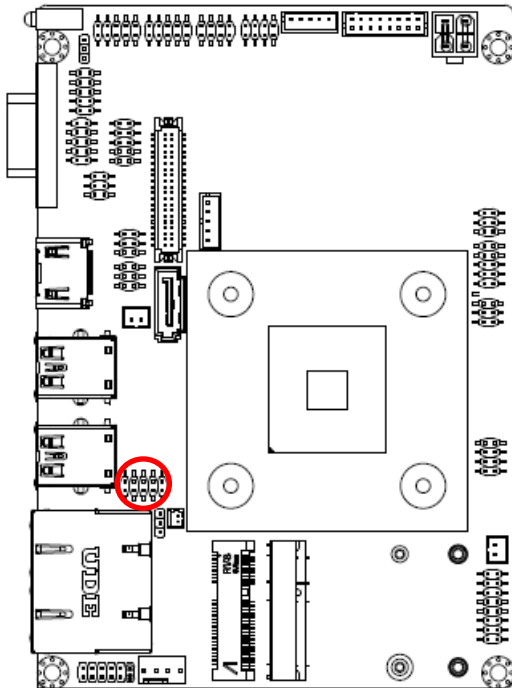

Signal	PIN	PIN	Signal
USBVCC_HSIC12	1	2	GND
HSIC_DN_2	3	4	GND
HSIC_DP_2	5	6	HSIC_DP_1
GND	7	8	HSIC_DN_1
GND	9	10	USBVCC_HSIC12

### 2.3.17 EC Debug connector (JECDEBUG)

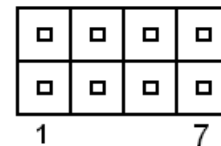
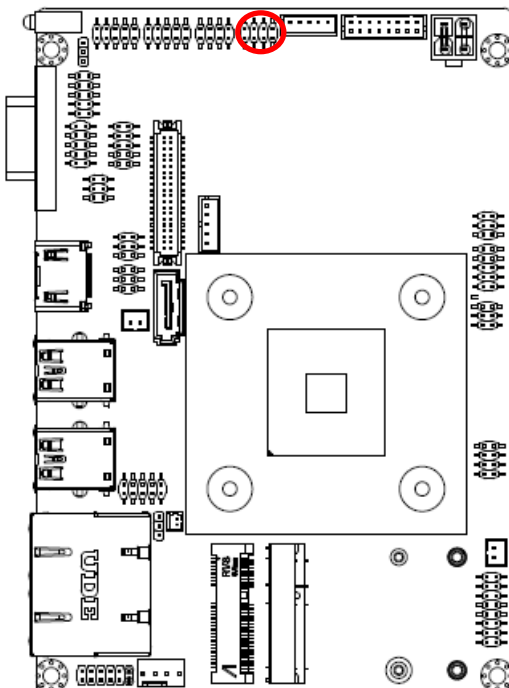

Signal	PIN	PIN	Signal
KSO0	1	2	KSO12
KSO13	3	4	KSO14
KSO5	5	6	KSO6
GND	7	8	NC

2.3.18 PS/2 keyboard & mouse header (JKBMS1)

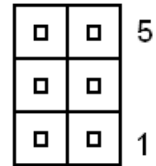
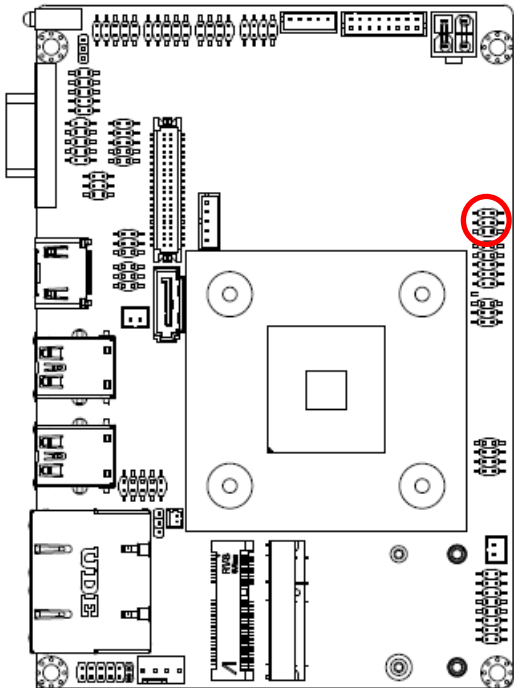

Signal	PIN	PIN	Signal
MSCK	6	5	MSDT
KBVCC	4	3	GND
KBCK	2	1	KBDT

2.3.19 Serial port 1 in RS-422/485 mode (J422\_485)

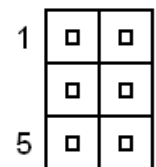
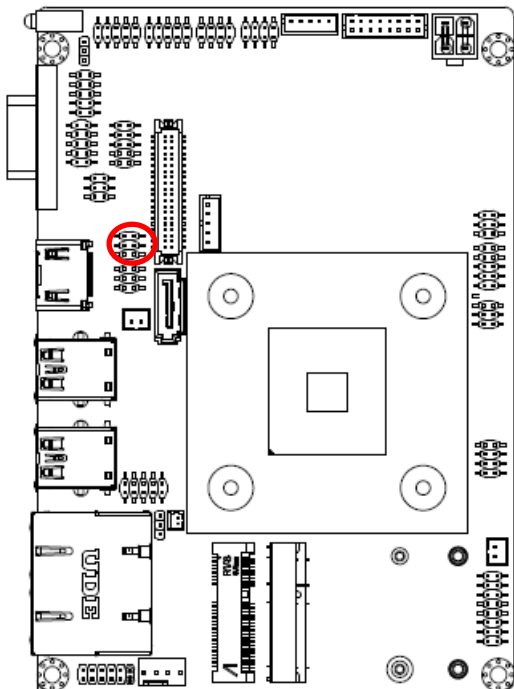

Signal	PIN	PIN	Signal
485TX2-	1	2	485RX2-
485TX2+	3	4	485RX2+
+5V	5	6	GND

### 2.3.20 Miscellaneous setting connector (JFP1)

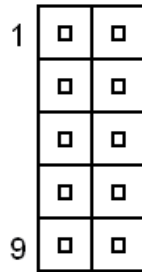
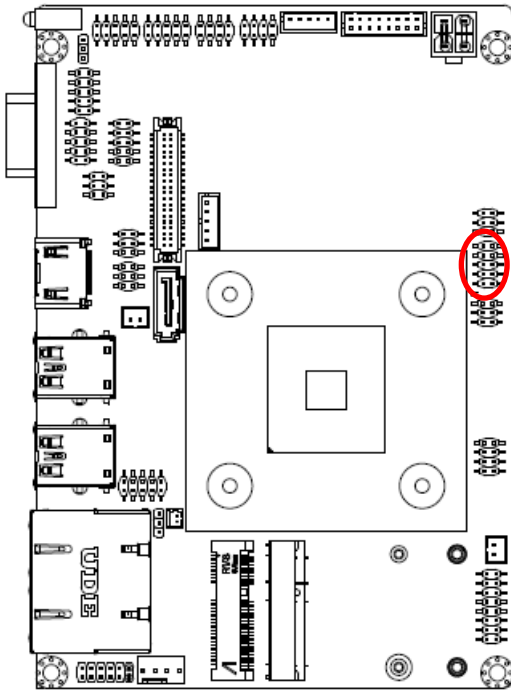

Signal	PIN
PWBT	1
	2
RST#	3
	4
PWR-LED+	5
PWR-LED-	6
HDD-LED-	7
HDD-LED+	8
NC	9
	10

### 2.3.21 BIOS SPI header (BIOS\_SPI1)

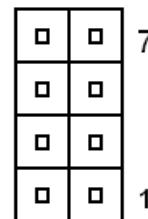
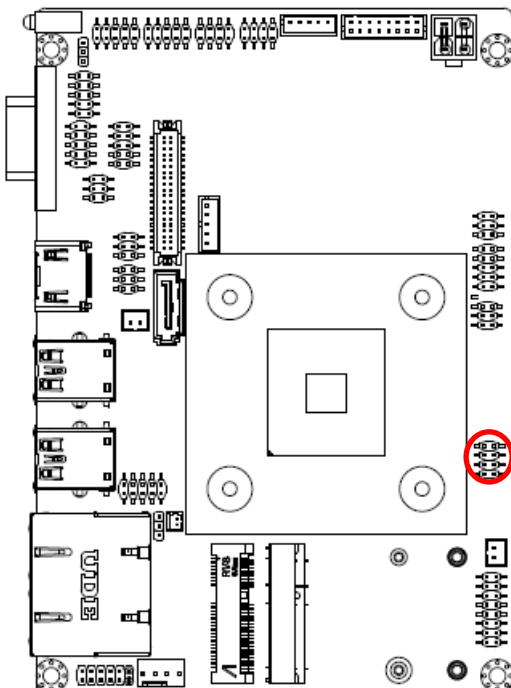

Signal	PIN	PIN	Signal
NC	8	7	SPI_HOLD#
SPI_MOSI	6	5	SPI_MISO
CPI_CLK	4	3	SPI_CS#0
GND	2	1	+1.8VSB

2.3.22 PC Buzzer header (JBZ1)

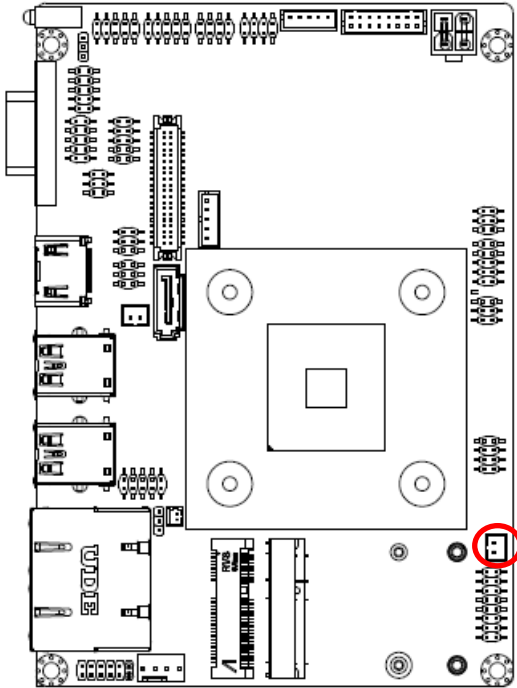

Signal	PIN
+5V	2
SOC_SPKR_R	1

2.3.23 Battery connector (BT1)

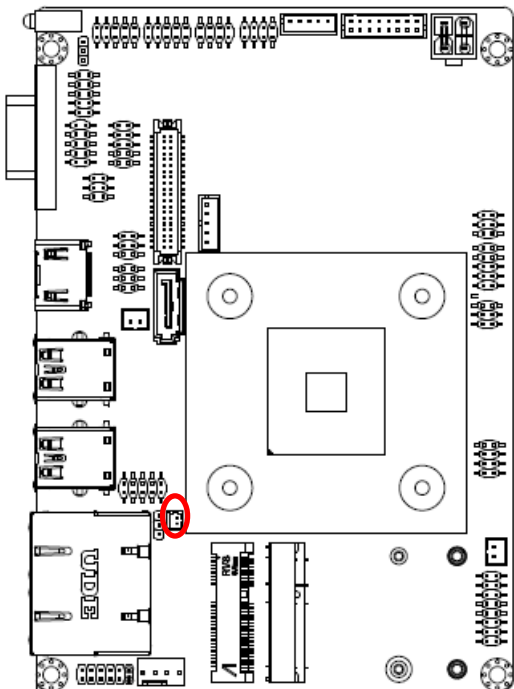

Signal	PIN
+RTCBATT	2
GND	1

### 2.3.24 Audio connector (JAUDIO1)

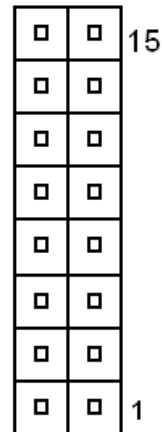
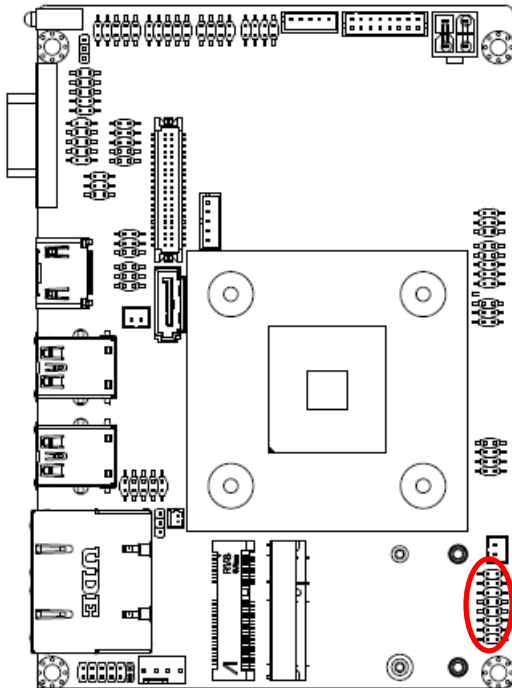

Signal	PIN	PIN	Signal
SPK_R-	16	15	SPK_L-
SPK_R+	14	13	SPK_L+
HD_AGND	12	11	MIC1-JD
LINE1-JD	10	9	FRONT-JD
MIC1-L-IN	8	7	MIC1-R-IN
LIN1-L-IN	6	5	LINE1-R-IN
HD_AGND	4	3	HD_AGND
FRONT-L-OUT	2	1	FRONT-R-OUT

#### 2.3.24.1 Signal Description – Audio connector (JAUDIO1)

Signal	Signal Description
LINE1-JD	AUDIO IN (LINE_RIN/LIN)sense pin
FRONT-JD	AUDIO Out(ROUT/LOUT) sense pin
MIC1-JD	MIC IN (MIC_RIN/LIN) sense pin

2.3.25 VGA header (JVGA1)

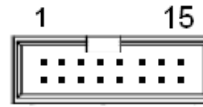
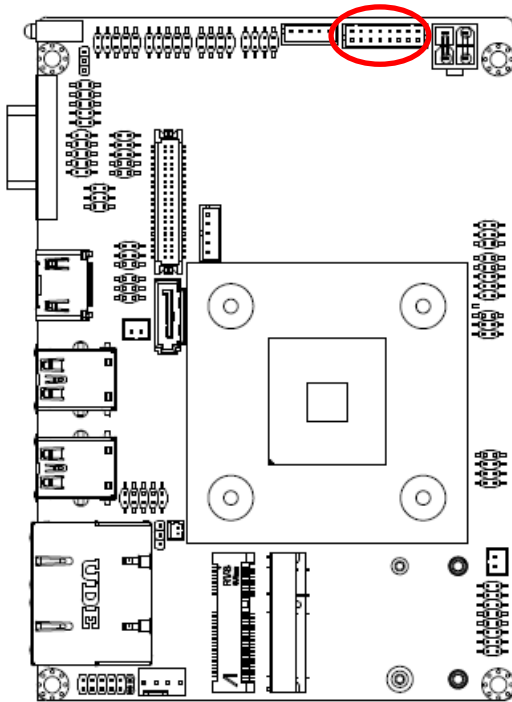

Signal	PIN	PIN	Signal
+5V	1	2	VGA_RED
GND	3	4	VGA_GREEN
NC	5	6	VGA_BLUE
VGA_DDCDAT	7	8	NC
VGA_HSYNC_R	9	10	GND
VGA_VSYNC_R	11	12	GND
VGA_DDCCLK	13	14	GND
GND	15	16	GND

2.3.26 LPC connector (JLPC1)

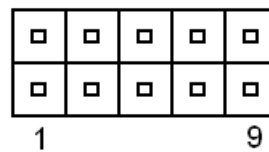
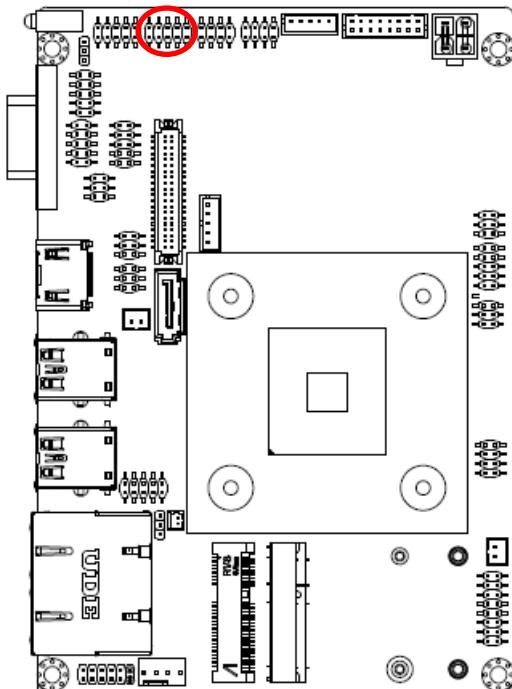

Signal	PIN	PIN	Signal
LPC_AD0	1	2	+3.3V
LPC_AD1	3	4	LPC_PORT80_RST#
LPC_AD	5	6	LPC_FRAME#
LPC_AD03	7	8	LPC_PORT80_CLK
LPC_SERIRQ	9	10	GND



# 3. BIOS Setup

---

### 3.1 Introduction

The BIOS setup program allows users to modify the basic system configuration. In this following chapter will describe how to access the BIOS setup program and the configuration options that may be changed.

### 3.2 Starting Setup

Insyde BIOS™ is immediately activated when you first power on the computer. The BIOS reads the system information contained in the NVRAM and begins the process of checking out the system and configuring it. When it finishes, the BIOS will seek an operating system on one of the disks and then launch and turn control over to the operating system.

While the BIOS is in control, the Setup program can be activated in one of two ways:

By pressing <F2> immediately after switching the system on, or

By pressing the <F2> key when the following message appears briefly at the left-top of the screen during the POST (Power On Self Test).

**Press <F2> to enter SETUP**

If the message disappears before you respond and you still wish to enter Setup, restart the system to try again by turning it OFF then ON or pressing the "RESET" button on the system case. You may also restart by simultaneously pressing <Ctrl>, <Alt>, and <Delete> keys.

### 3.3 Using Setup

In general, you use the arrow keys to highlight items, press <Enter> to select, use the PageUp and PageDown keys to change entries, press <F1> for help and press <Esc> to quit. The following table provides more detail about how to navigate in the Setup program using the keyboard.

Button	Description
↑	Move to previous item
↓	Move to next item
←	Move to the item in the left hand
→	Move to the item in the right hand
Esc key	Main Menu -- Quit and not save changes into NVRAM Status Page Setup Menu and Option Page Setup Menu -- Exit current page and return to Main Menu
+ key	Increase the numeric value or make changes
- key	Decrease the numeric value or make changes
F1 key	General help, only for Status Page Setup Menu and Option Page Setup Menu
F9 key	Optimized defaults
F10 key	Save & Exit Setup

- **Navigating Through The Menu Bar**

Use the left and right arrow keys to choose the menu you want to be in.



**Note:** Some of the navigation keys differ from one screen to another.

- **To Display a Sub Menu**

Use the arrow keys to move the cursor to the sub menu you want. Then press <Enter>. A “➤” pointer marks all sub menus.

### 3.4 Getting Help

Press F1 to pop up a small help window that describes the appropriate keys to use and the possible selections for the highlighted item. To exit the Help Window press <Esc> or the F1 key again.

### 3.5 In Case of Problems

If, after making and saving system changes with Setup, you discover that your computer no longer is able to boot, the Insyde BIOS supports an override to the NVRAM settings which resets your system to its defaults.

The best advice is to only alter settings which you thoroughly understand. To this end, we strongly recommend that you avoid making any changes to the chipset defaults. These defaults have been carefully chosen by both BIOS Vendor and your systems manufacturer to provide the absolute maximum performance and reliability. Even a seemingly small change to the chipset setup has the potential for causing you to use the override.

## 3.6 BIOS setup

Once you enter the InsydeH2O Setup Utility, the Main Menu will appear on the screen. The Main Menu allows you to select from several setup functions and exit choices. Use the arrow keys to select among the items and press <Enter> to accept and enter the sub-menu.

### 3.6.1 Main Menu

This section allows you to record some basic hardware configurations in your computer and set the system clock.

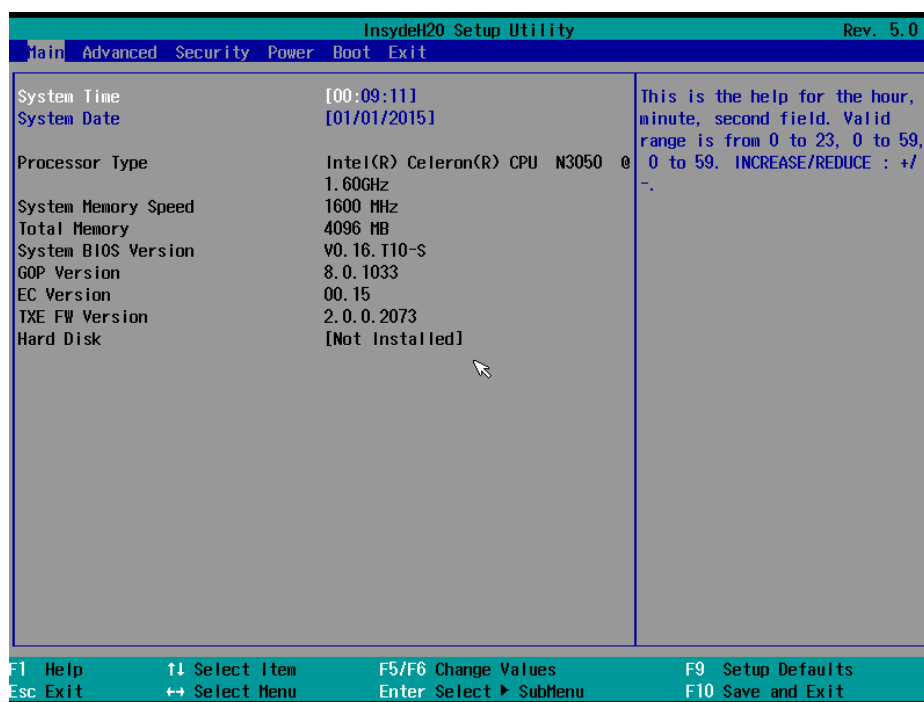

#### 3.6.1.1 System Time

Use the system time option to set the system time. Manually enter the hours, minutes and seconds.

#### 3.6.1.2 System Date

Use the system date option to set the system date. Manually enter the day, month and year.



**Note:** The BIOS setup screens shown in this chapter are for reference purposes only, and may not exactly match what you see on your screen.

Visit the Avalue website ([www.avalue.com.tw](http://www.avalue.com.tw)) to download the latest product and BIOS information.

# ECM-BSW User's Manual

## 3.6.2 Advanced Menu

This section allows you to configure your CPU and other system devices for basic operation through the following sub-menus.

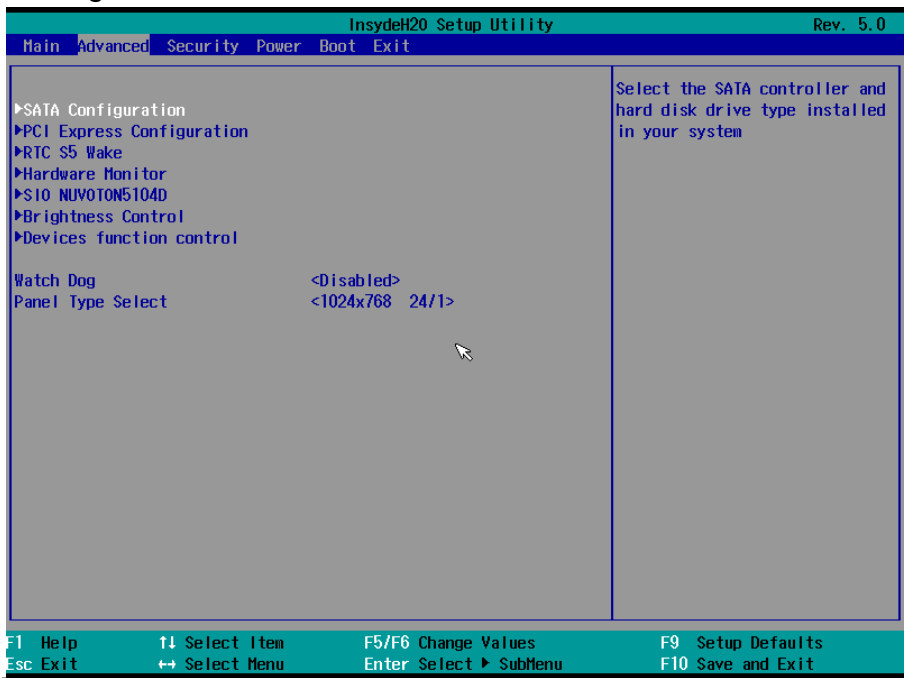

Item	Options	Description
<b>Watch Dog</b>	Disabled[Default], 30 sec 40 sec 50 sec 1 min 2 min 10 min 30 min	Select WatchDog items.
<b>Panel Type Select</b>	1024x768 24/1[Default] 800x600 18/1 1024x768 18/1 1366x768 18/1 1024x600 18/1 1280x800 18/1 1920x1200 24/2 640x480 18/1 800x480 18/1 1920x1080 18/2 1280x1024 24/2 1440x900 18/2 1600x1200 24/2 1366x768 24/1 1920x1080 24/2 1680x1050 24/2	Select Panel Type for display.

### 3.6.2.1 SATA Configuration

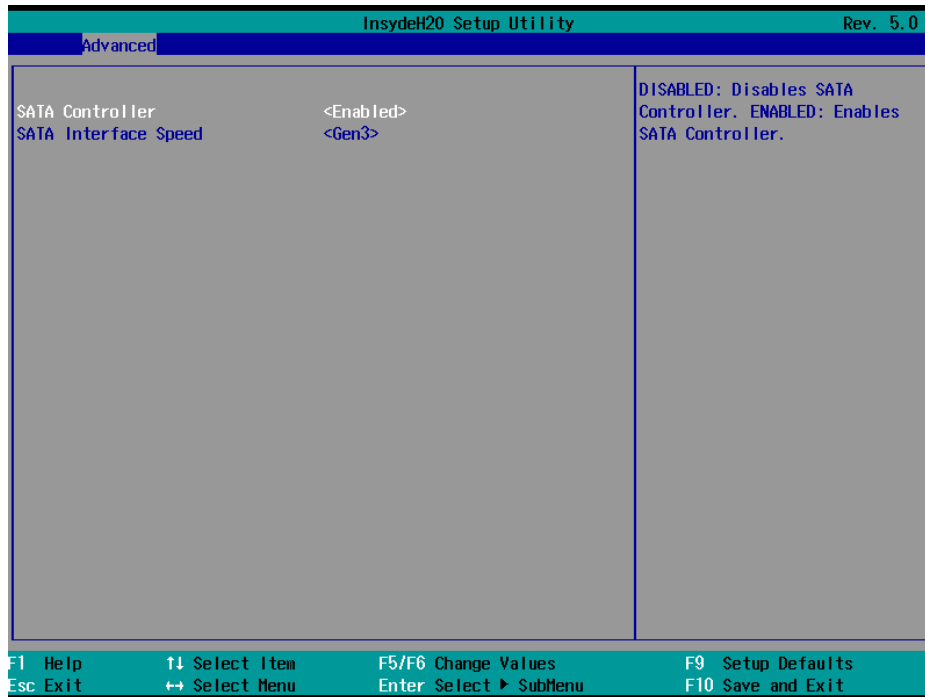

Item	Options	Description
SATA Controller	Disabled, Enabled[Default]	SATA Controller.
SATA Interface Speed	Gen1 Gen2 Gen3[Default]	Select SATA Interface Speed.

### 3.6.2.2 PCI Express Configuration

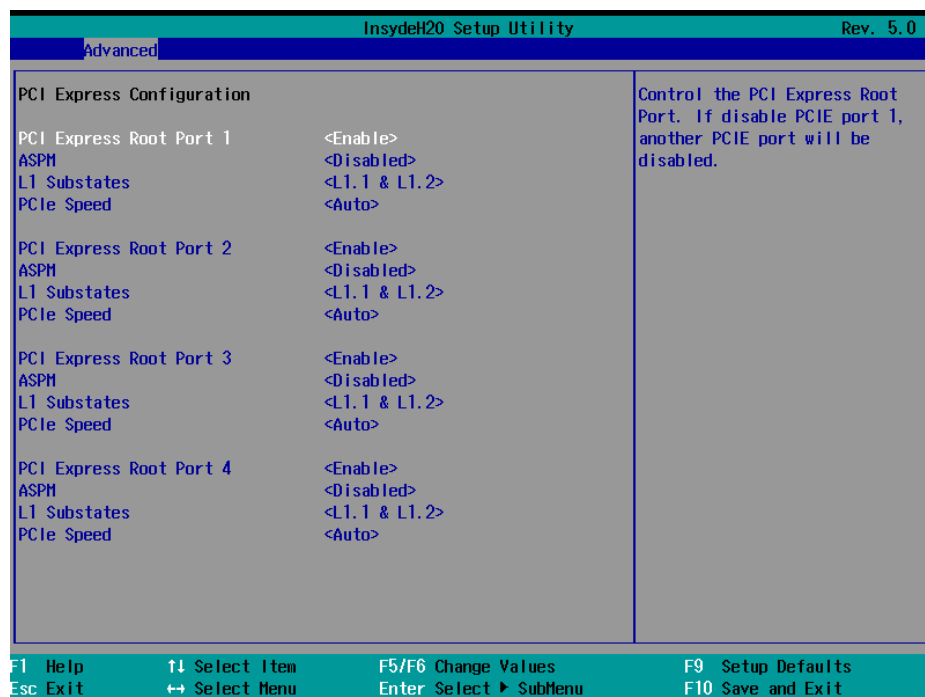

## ECM-BSW User's Manual

Item	Options	Description
PCI Express Root Port 1/2/3/4	Disabled Enabled[Default],	Control the PCI Express Root Port. If disable PCIE port 1, another PCIE port will be disabled.
ASPM	Disabled[Default] L0s L1 L0sL1	PCI Express Active State Power Management settings.
L1 Substates	Disabled[Default] L1.1 & L1.2 L1.1 L1.2	PCI Express L1 Substates settings.
PCIe Speed	Auto[Default] Gen 1 Gen 2	Configure PCIe Speed.

### 3.6.2.3 RTC S5 Wake

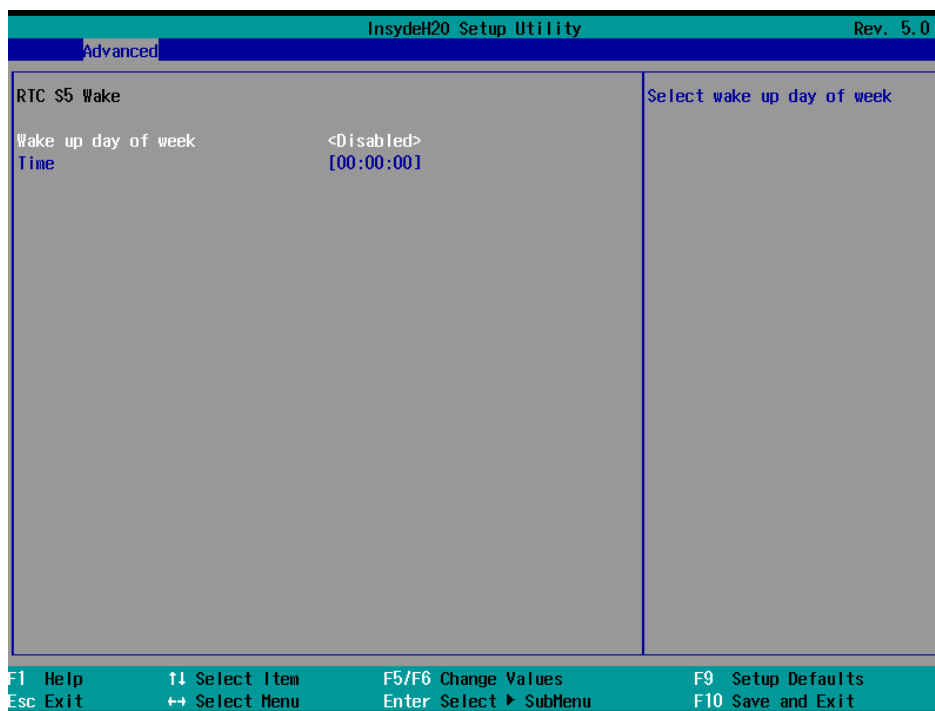

Item	Options	Description
Wake up day of week	Monday-Friday Monday-Saturday Every Day Disabled[Default]	Select wake up day of week.
Time	[00:00:00][Default]	This is the help for the hour, minute second field. Valid range is from 0 to 23, 0 to 59, 0 to 59. INCREASE/REDUCE : +/-.



### 3.6.2.4 Hardware Monitor

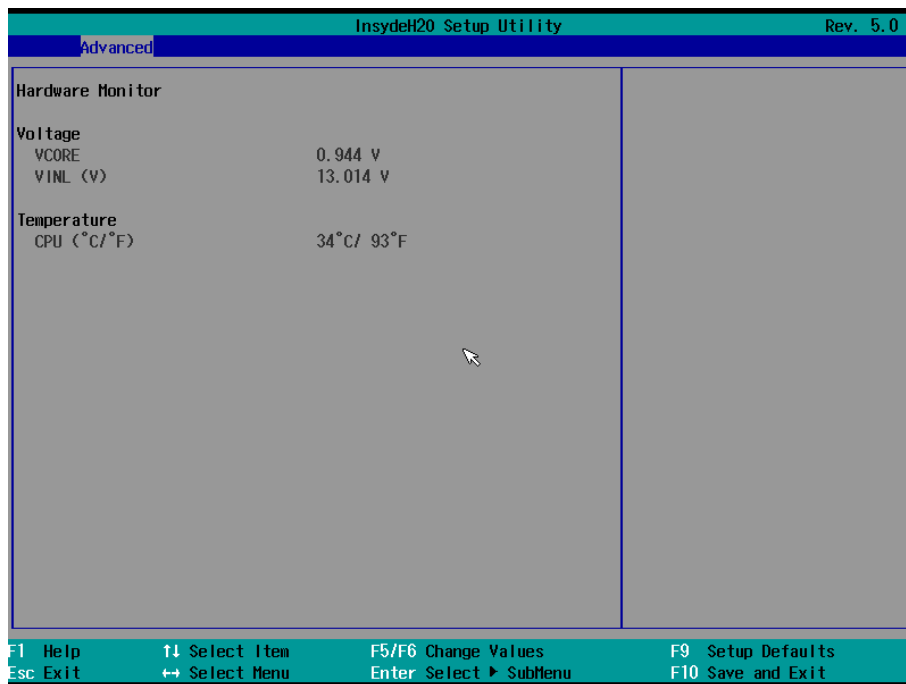

### 3.6.2.5 SIO NUVOTON5104D

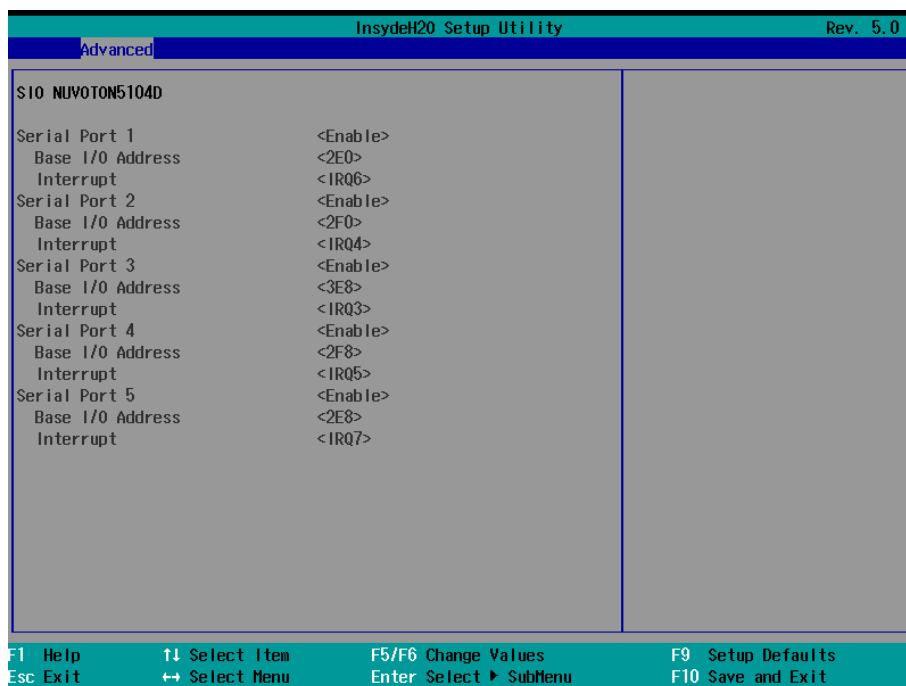

3.6.2.6 Brightness Control

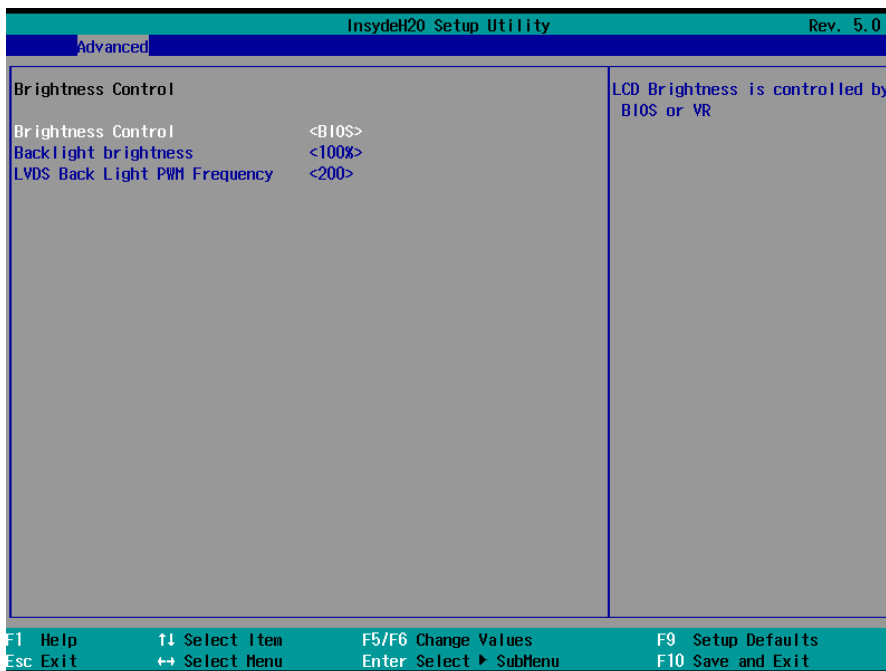

Item	Options	Description
<b>Brightness Control</b>	VR BIOS[Default]	LCD Brightness is controlled by BIOS or VR.
<b>Backlight brightness</b>	0% 25% 50% 75% 100%[Default]	Backlight brightness percentage.
<b>LVDS Back Light PWM Frequency</b>	200[Default] 300 400 500 700 1k 2k 3k 5k 10k 20k	LVDS Back Light PWM Frequency.

### 3.6.2.7 Device function Control

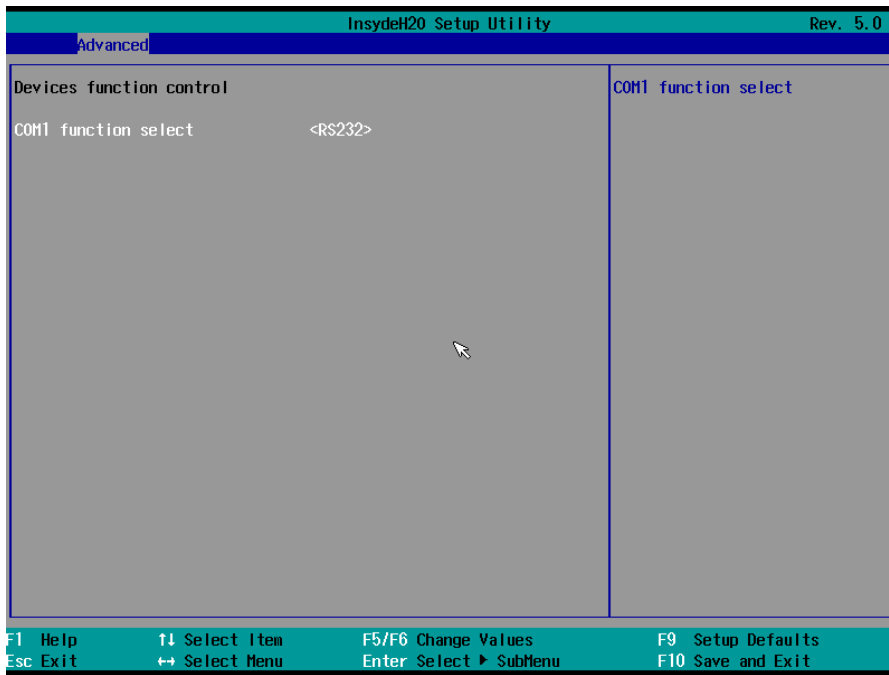

Item	Options	Description
COM1 function select	RS232[Default] RS422 RS485	Select COM1 function as RS232/422/485.

### 3.6.3 Security

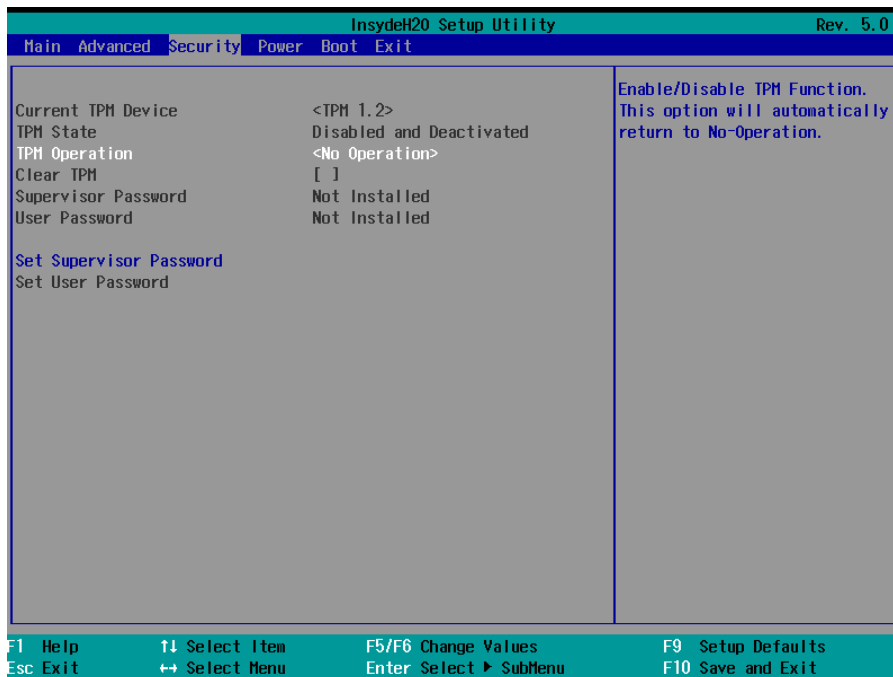

# ECM-BSW User's Manual

Item	Options	Description
TPM Operation	No Operation[Default] Disable and Deactivate Enable and Activate	Enable/Disable TPM Function. This option will automatically return to No-Operation.
Set Supervisor Password	Set Supervisor Password. Install or Change the password and the length of password must be greater than on character	

## 3.6.4 Power

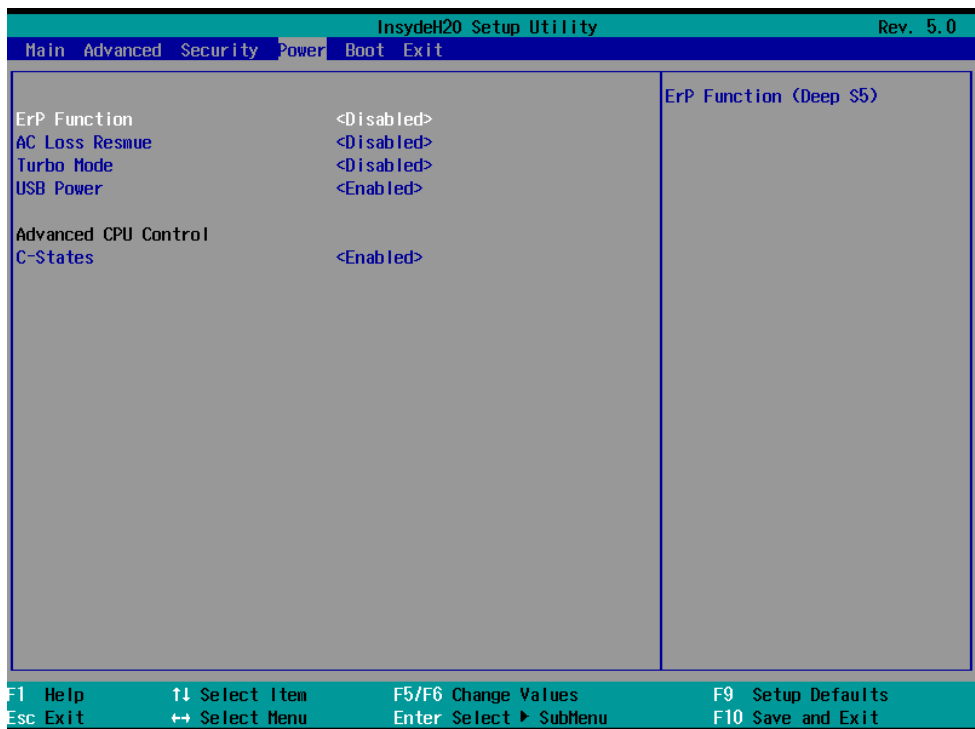

Item	Option	Description
Erp Function	Disabled[Default] Enabled	ErP Function (Deep S5).
AC Loss Resume	Disabled[Default] Enabled	AC Loss Resume setting.
Turbo Mode	Disabled Enabled[Default]	Enable processor Turbo Mode(requires EMTTM enabled too).
USB Power	Disabled Enabled[Default]	USB Power on standby.
C-States	Disabled Enabled[Default]	Enable processor idle power saving states (C-States).

### 3.6.5 Boot

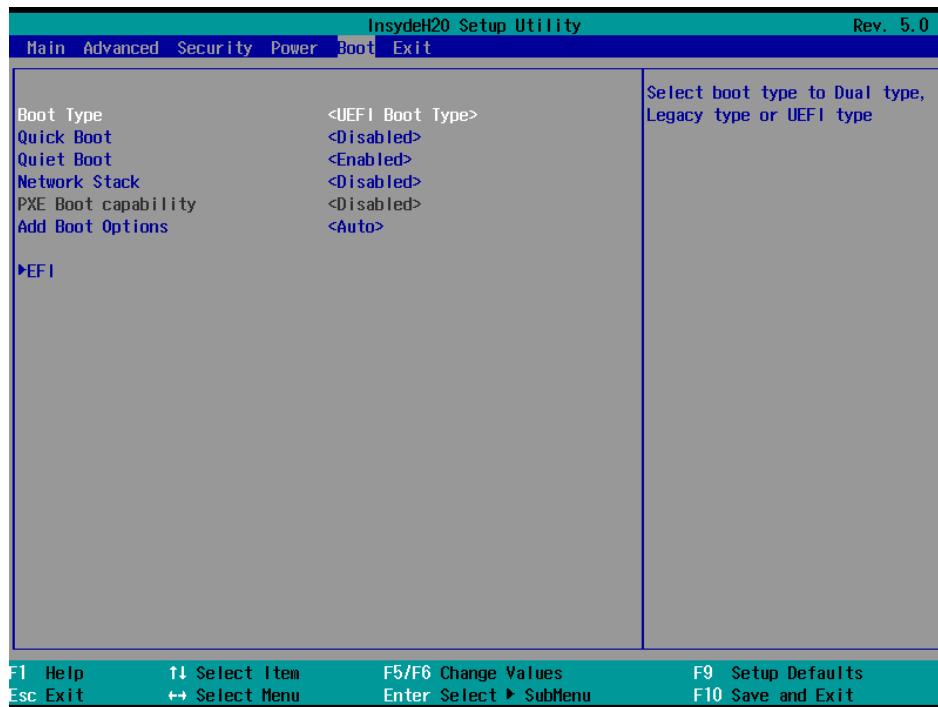

Item	Option	Description
<b>Boot Type</b>	Legacy Boot Type UEFI Boot Type[ <b>Default</b> ]	Select boot type to Legacy type or UEFI type.
<b>Quick Boot</b>	Disabled[ <b>Default</b> ] Enabled	Allows InsydeH20 to skip certain tests while booting. This will decrease the time needed to boot the system.
<b>Quiet Boot</b>	Disabled Enabled[ <b>Default</b> ]	Disables or enables booting in Text Mode.
<b>Network Stack</b>	Disabled[ <b>Default</b> ] Enabled	Network Stack Support: Windows 8 BitLocker Unlock UEFI IPv4/ IPv6 PXE Legacy PXE OPROM.
<b>Add Boot Options</b>	First Auto[ <b>Default</b> ]	Position in Boot Order for Shell, Network and Removables.

## 3.6.6 Exit

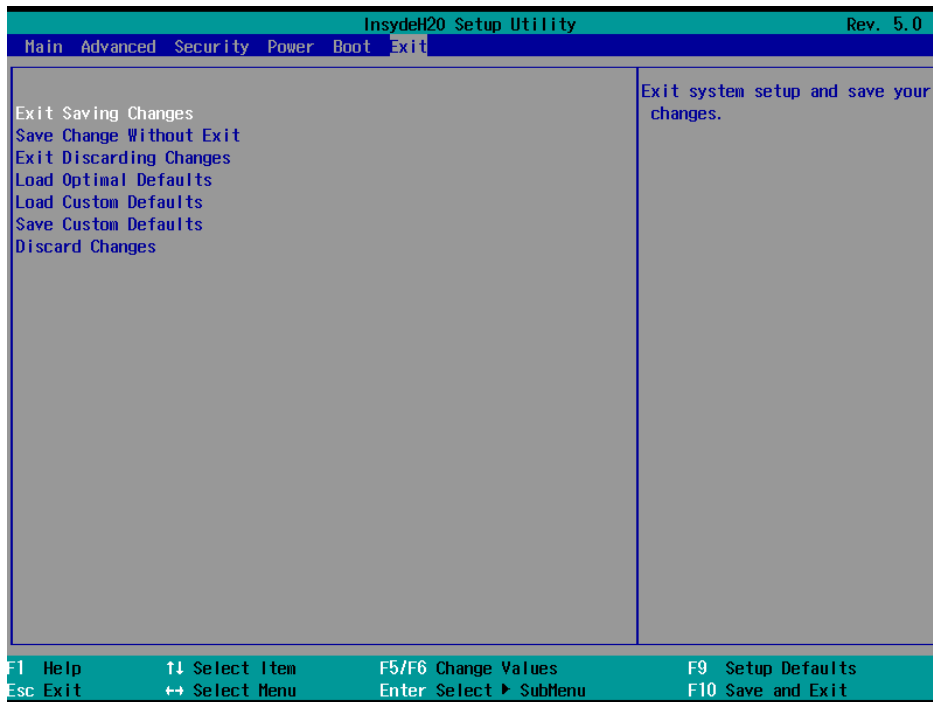

### 3.6.6.1 Exit Saving Changes

Exit system setup and save your changes.

### 3.6.6.2 Save Change Without Exit

Save your changes and without exiting system.

### 3.6.6.3 Exit Discarding Changes

Exit system setup and without saving your changes.

### 3.6.6.4 Load Optimal Defaults

Load Optimal Defaults.

### 3.6.6.5 Load Custom Defaults

Load Custom Defaults.

### 3.6.6.6 Save Custom Defaults

Save Custom Defaults.

### 3.6.6.7 Discard Changes

Discard Changes.

# 4. Drivers Installation

---



**Note:** Installation procedures and screen shots in this section are for your reference and may not be exactly the same as shown on your screen.

## 4.1 Install Chipset Driver

Insert the Supporting DVD-ROM to DVD-ROM drive, and it should show the index page of Avalue's products automatically. If not, locate Index.htm and choose the product from the menu left, or link to `\Driver_Chipset\Intel\ECM-BSW`.



**Note:** The installation procedures and screen shots in this section are based on Windows 8.1 operation system. If the warning message appears while the installation process, click Continue to go on.

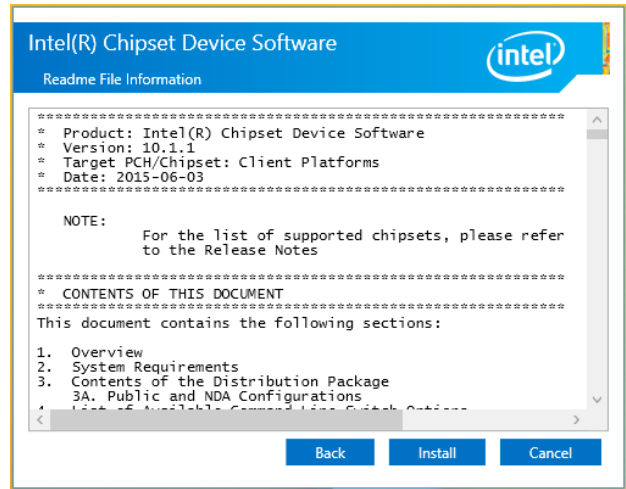

**Step 3. Click Install.**



**Step1. Click Next.**



**Step 4. Click Finish** to complete setup.



**Step 2. Click Accept.**



## 4.2 Install Nuvoton Driver

Insert the Supporting DVD-ROM to DVD-ROM drive, and it should show the index page of Avalue's products automatically. If not, locate Index.htm and choose the product from the menu left, or link to **Utility\ECM-BSW\_Nuvoton**.



**Note:** The installation procedures and screen shots in this section are based on Windows 8.1 operation system. If the warning message appears while the installation process, click Continue to go on.

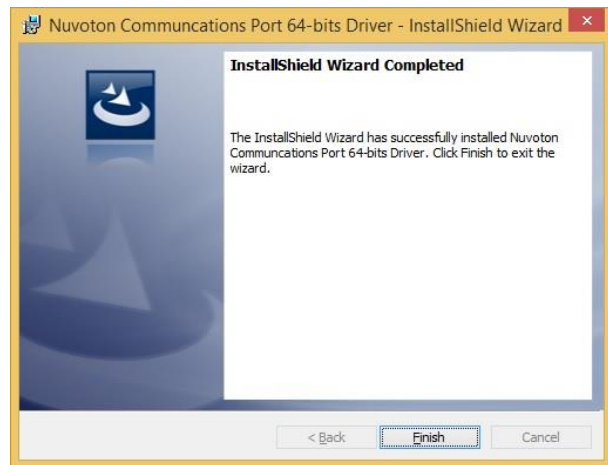

**Step 3.** Click **Finish** to complete setup.

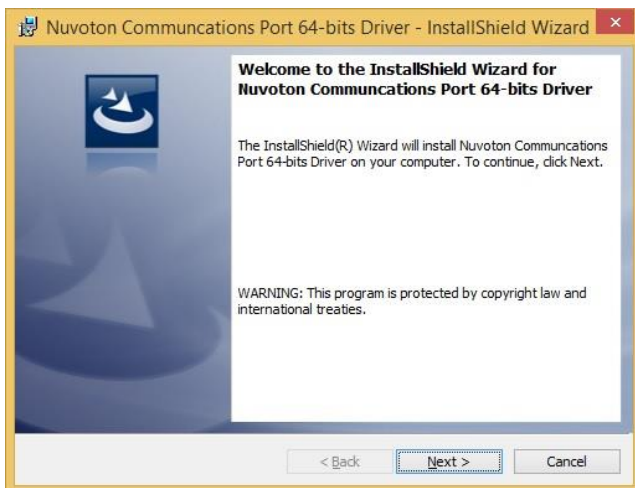

**Step1.** Click **Next** to start installation.

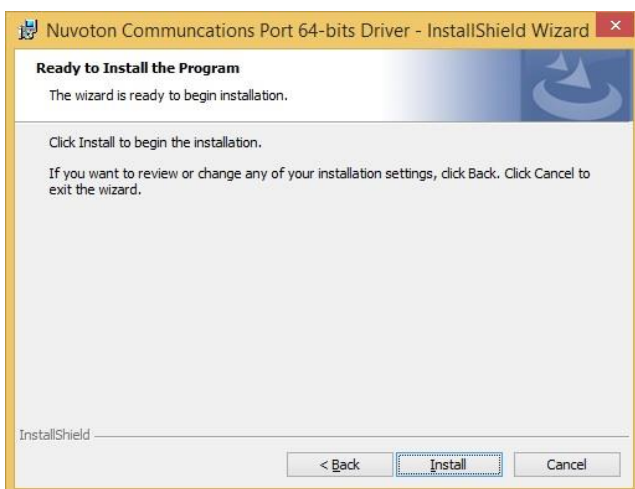

**Step 2.** Click **Install** to proceed setup.

## 4.3 Install TXE Driver

Insert the Supporting DVD-ROM to DVD-ROM drive, and it should show the index page of Avalue's products automatically. If not, locate Index.htm and choose the product from the menu left, or link to \Utility\ECM-BSW\_TXE.



**Note:** The installation procedures and screen shots in this section are based on Windows 8.1 operation system. If the warning message appears while the installation process, click Continue to go on.

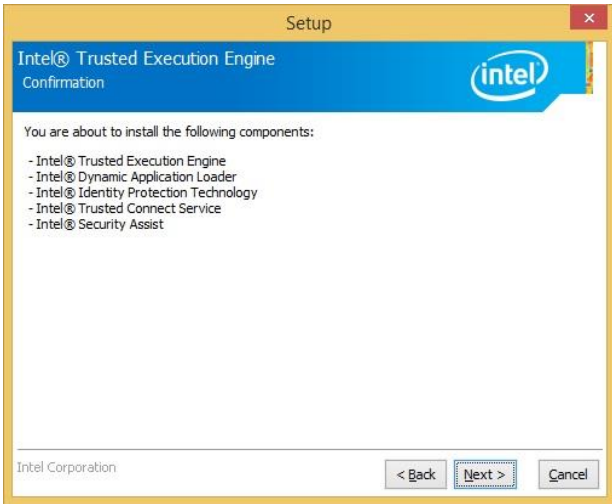

**Step 3.** Click **Next** to continue installation.

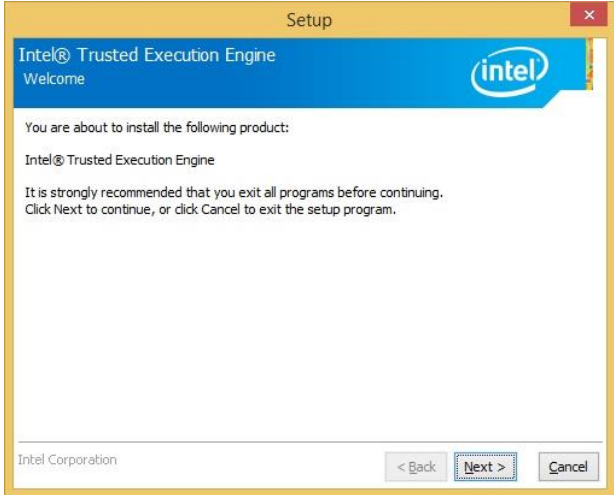

**Step1.** Click **Next** to start installation.



**Step 4.** Click **Install** to complete setup.



**Step 2.** Click **Next**.

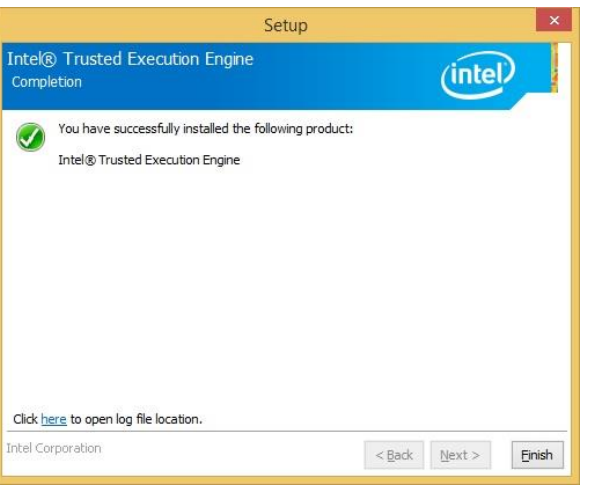

**Step 5.** Click **Finish** to complete setup.

## 4.4 Install VGA Driver

Insert the Supporting DVD-ROM to DVD-ROM drive, and it should show the index page of Avalue's products automatically. If not, locate Index.htm and choose the product from the menu left, or link to **WGAECM-BSW**.



**Note:** The installation procedures and screen shots in this section are based on Windows 8.1 operation system.

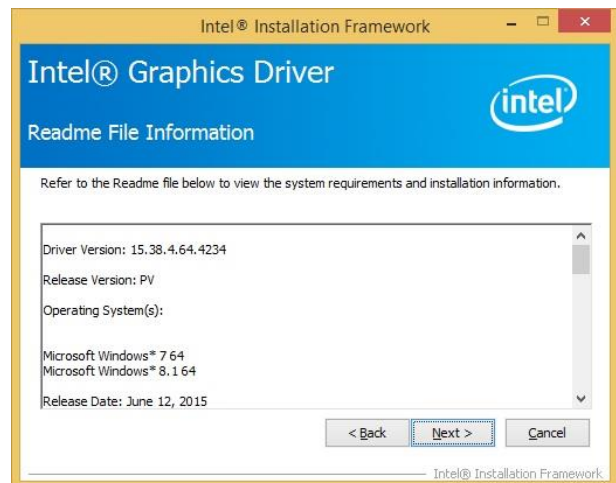

**Step 3. Click Next.**

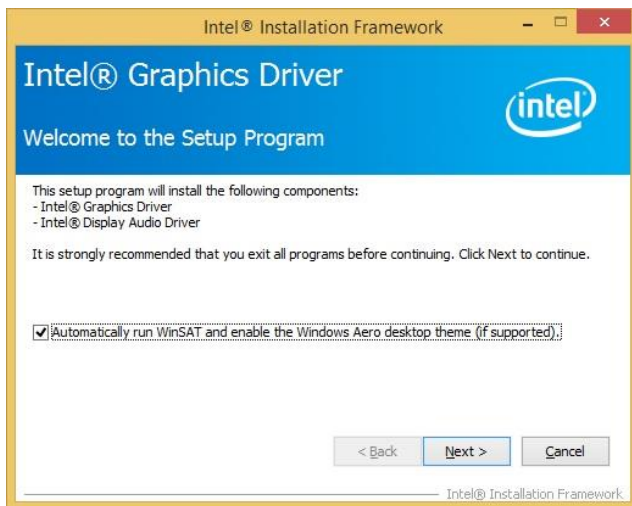

**Step 1. Click Next** to continue installation.

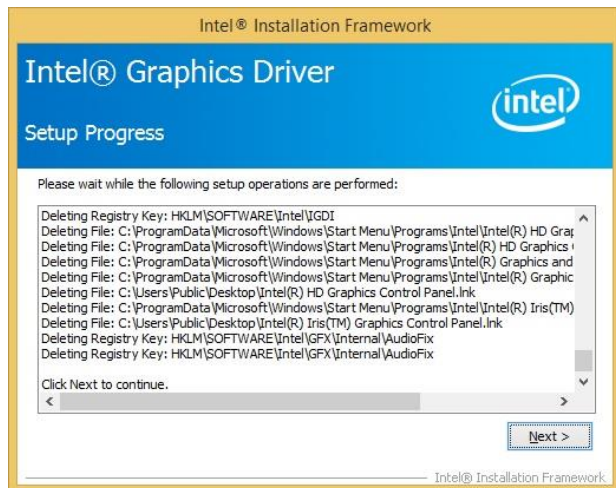

**Step 4. Click Next.**

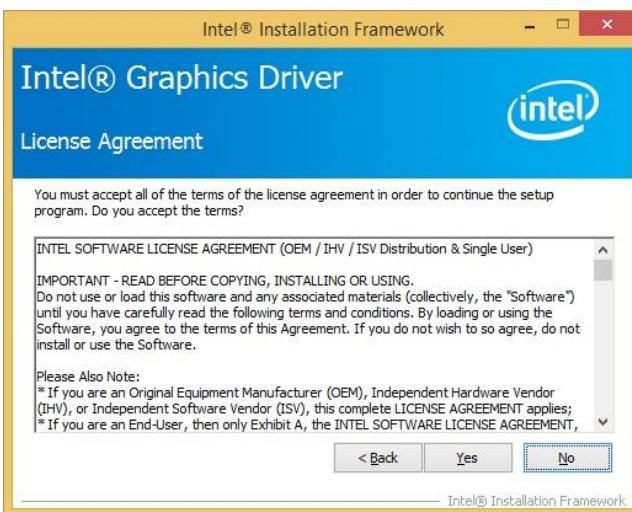

**Step 2.**  
Click **Yes** to accept license agreement.

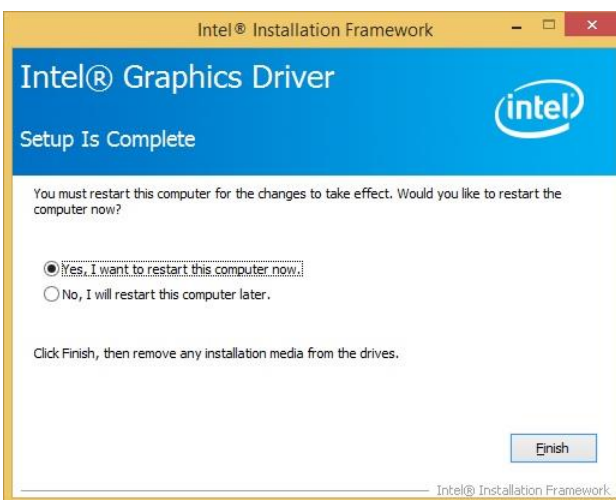

**Step 5. Click Finish** to complete setup.

## 4.5 Install Audio Driver (For Realtek ALC233)

Insert the Supporting CD-ROM to CD-ROM drive, and it should show the index page of Avalue's products automatically. If not, locate Index.htm and choose the product from the menu left, or link to **\Driver\_Audio\Realtek\ALC233\ECM-BSW\_Audio**.



**Note:** The installation procedures and screen shots in this section are based on Windows 8.1 operation system.

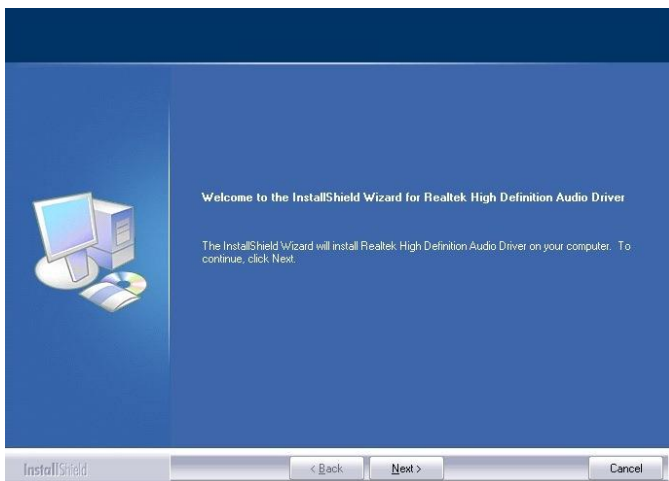

**Step 1.** Click **Next** to continue setup.

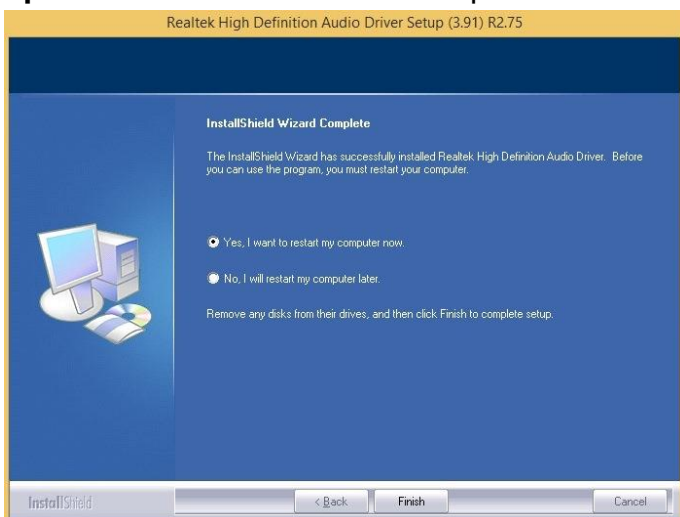

**Step 2.** Click **Finish** to complete the setup.

## 4.6 Install USB3.0 Driver

Insert the Supporting CD-ROM to CD-ROM drive, and it should show the index page of Avalue's products automatically. If not, locate Index.htm and choose the product from the menu left, or link to **\\Utility\ECM-BSW\_USB3.0**.



**Note:** The installation procedures and screen shots in this section are based on Windows 8.1 operation system.

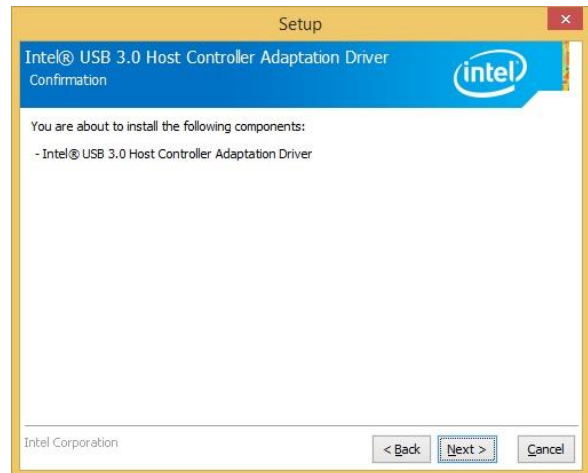

**Step 3. Click Next**

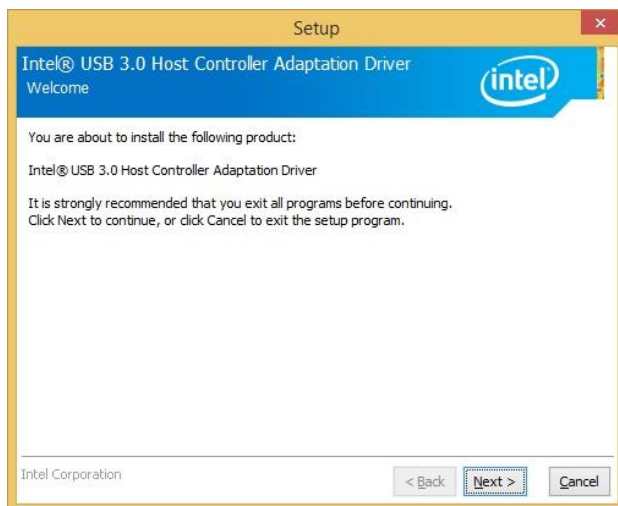

**Step 1. Click Next** to continue setup.

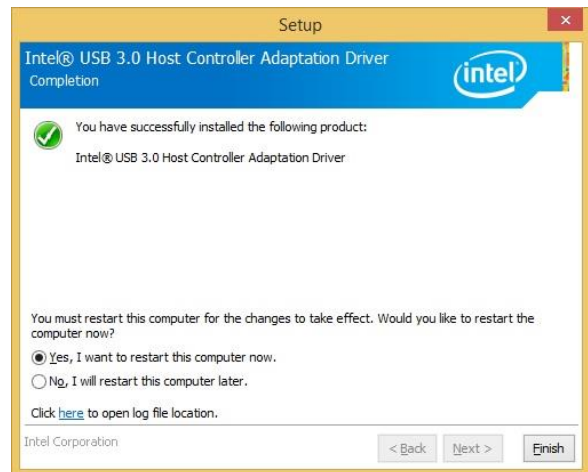

**Step 4. Click Finish** to complete the setup

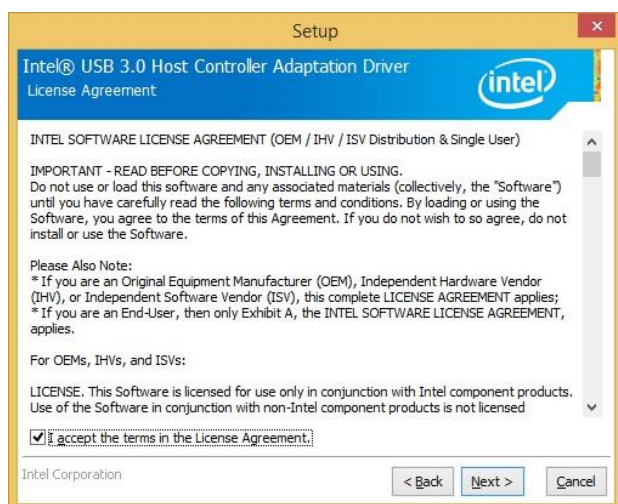

**Step 2. Click Next.**

## 4.7 Install Ethernet Driver

Insert the Supporting DVD-ROM to DVD-ROM drive, and it should show the index page of Avalue's products automatically. If not, locate Index.htm and choose the product from the menu left, or link to **\\Driver\_Gigabit\Realtek\RTL8119\ECM-BSW\_LAN.**



**Note:** The installation procedures and screen shots in this section are based on Windows 8.1 operation system.

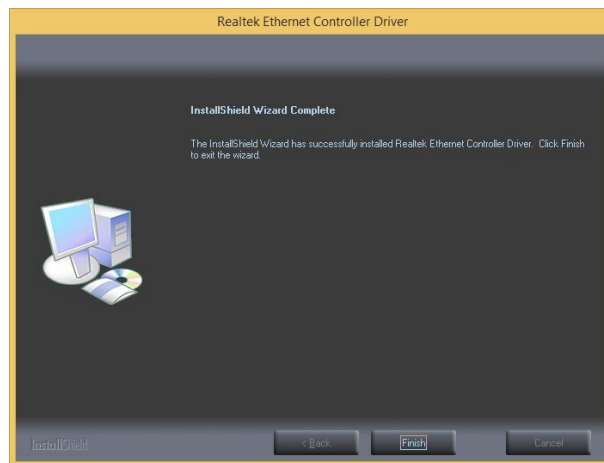

**Step 3.** Click **Finish** to complete the setup.

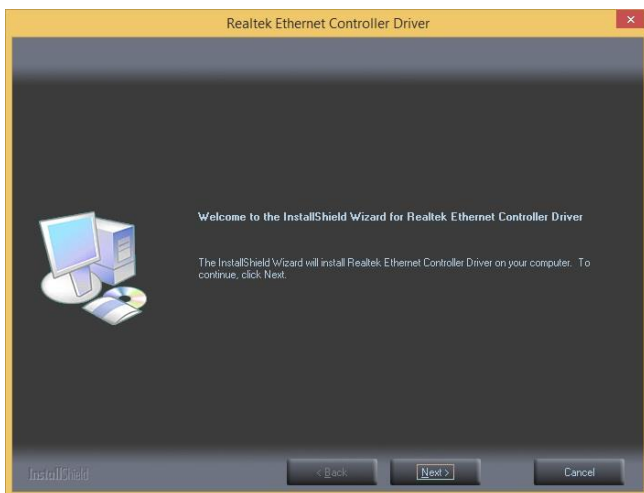

**Step 1.** Click **Next**.

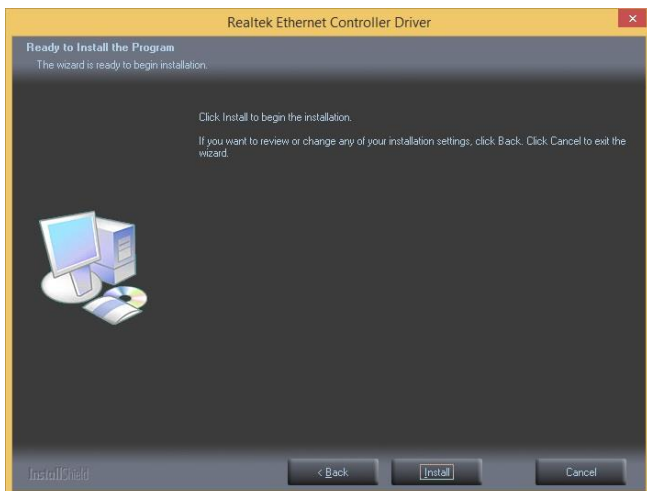

**Step 2.** Click **Install** to proceed.

## 4.8 Install Serial IO Driver

Insert the Supporting CD-ROM to CD-ROM drive, and it should show the index page of Avalue's products automatically. If not, locate Index.htm and choose the product from the menu left, or link to **\\Utility\ECM-BSW\_Serial IO**.



**Note:** The installation procedures and screen shots in this section are based on Windows 8.1 operation system.



**Step 1.** Click **Next** to continue setup.



**Step 2.** Click **Finish** to complete the setup.

## 4.9 Install SMSC Hub Driver

Insert the Supporting CD-ROM to CD-ROM drive, and it should show the index page of Avalue's products automatically. If not, locate Index.htm and choose the product from the menu left, or link to **\\Utility\ECM-BSW\_SMSC hub.**



**Note:** The installation procedures and screen shots in this section are based on Windows 8.1 operation system.



**Step 1.** Click **Install** to continue setup.

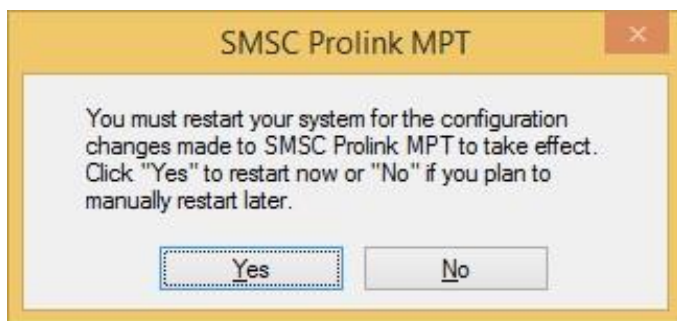

**Step 2.** Click **Yes** to complete the setup.



## 4.10 Install Touch Driver

Insert the Supporting DVD-ROM to DVD-ROM drive, and it should show the index page of Avalue's products automatically. If not, locate Index.htm and choose the product from the menu left, or link to **Utility\ECM-BSW\_Touch**.



**Note:** The installation procedures and screen shots in this section are based on Windows 8.1 operation system.



**Step 3. Click Next.**

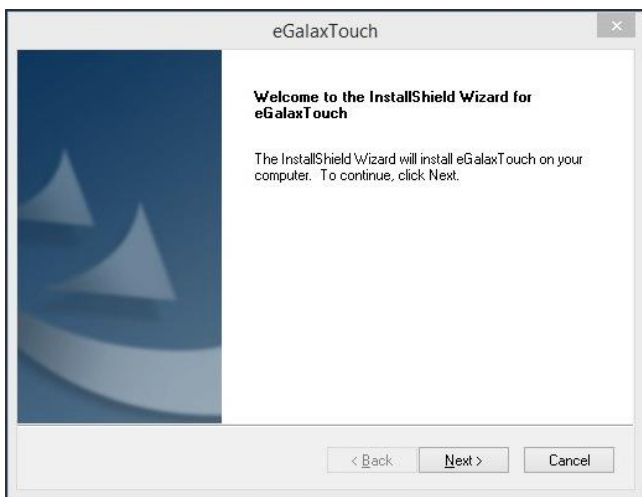

**Step 1. Click Next** to continue installation.

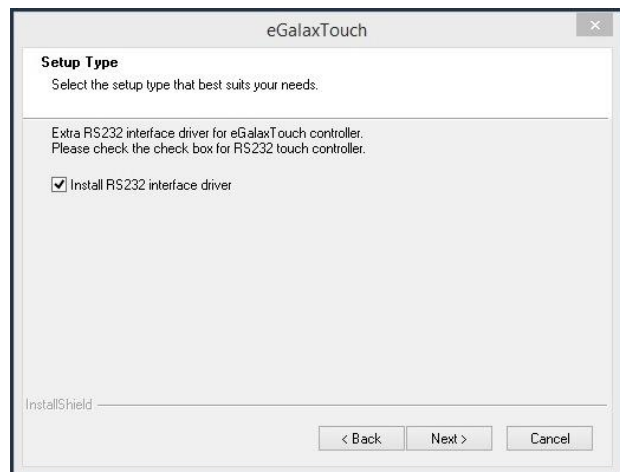

**Step 4. Click Next.**



**Step 2. Click Next.**



**Step 5. Click Next.**

# ECM-BSW User's Manual

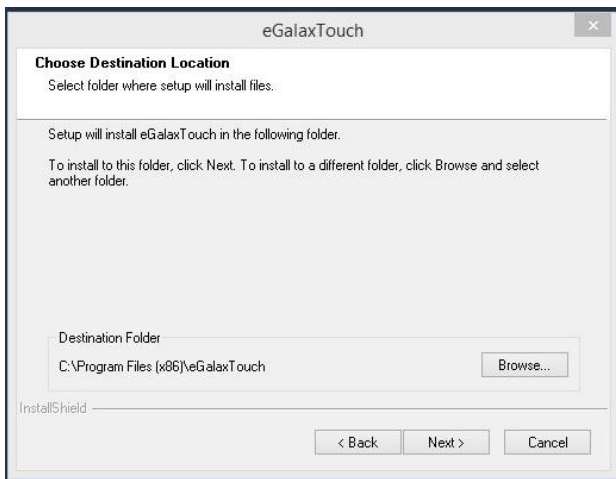

**Step 6. Click Next.**



**Step 9. Click Next.**

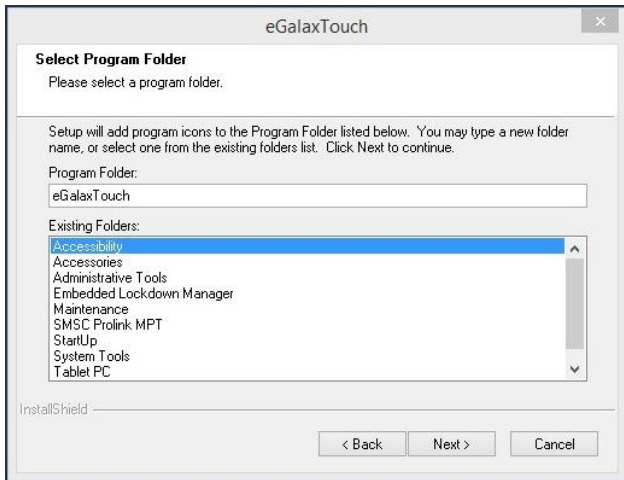

**Step 7. Click Next.**



**Step 8. Click Next.**

# 5. Mechanical Drawing

---

# ECM-BSW User's Manual

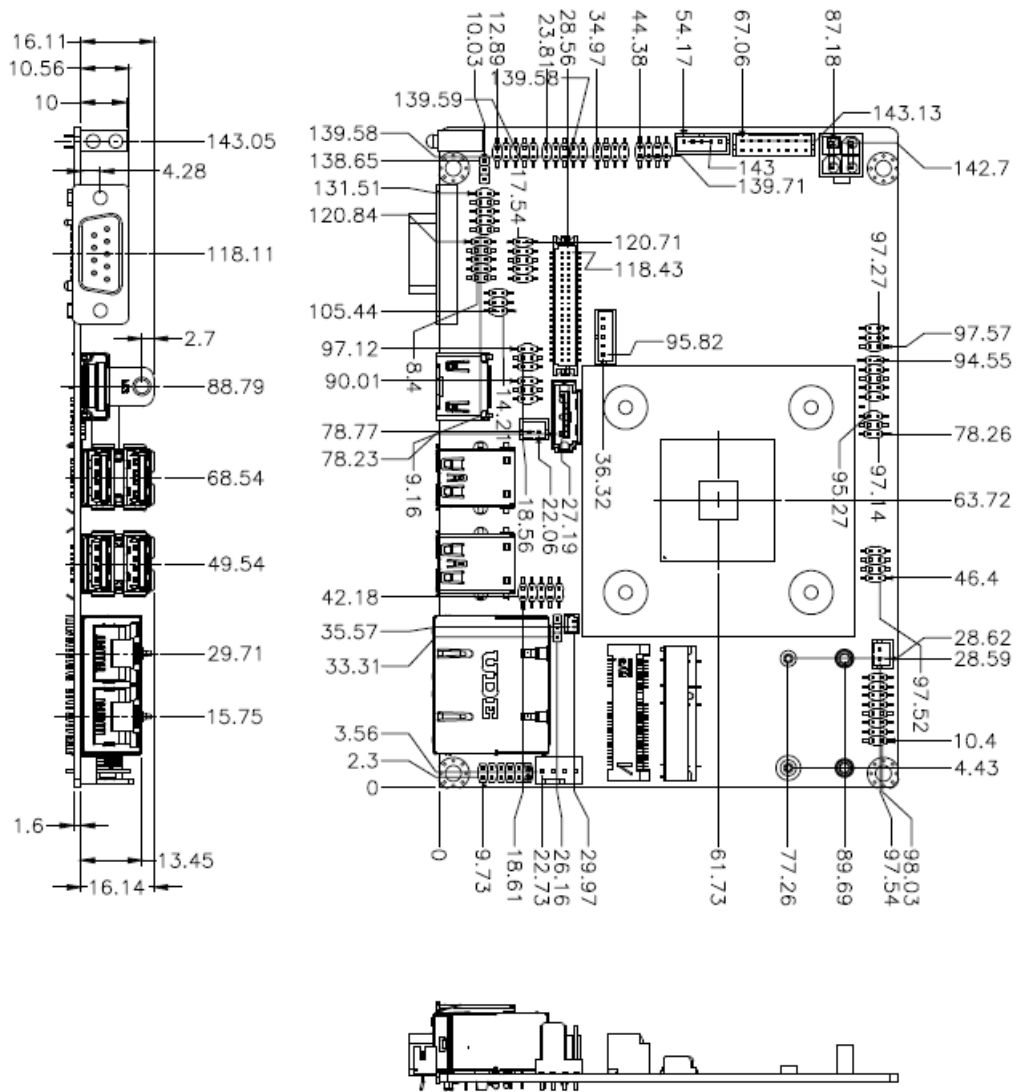

Unit: mm

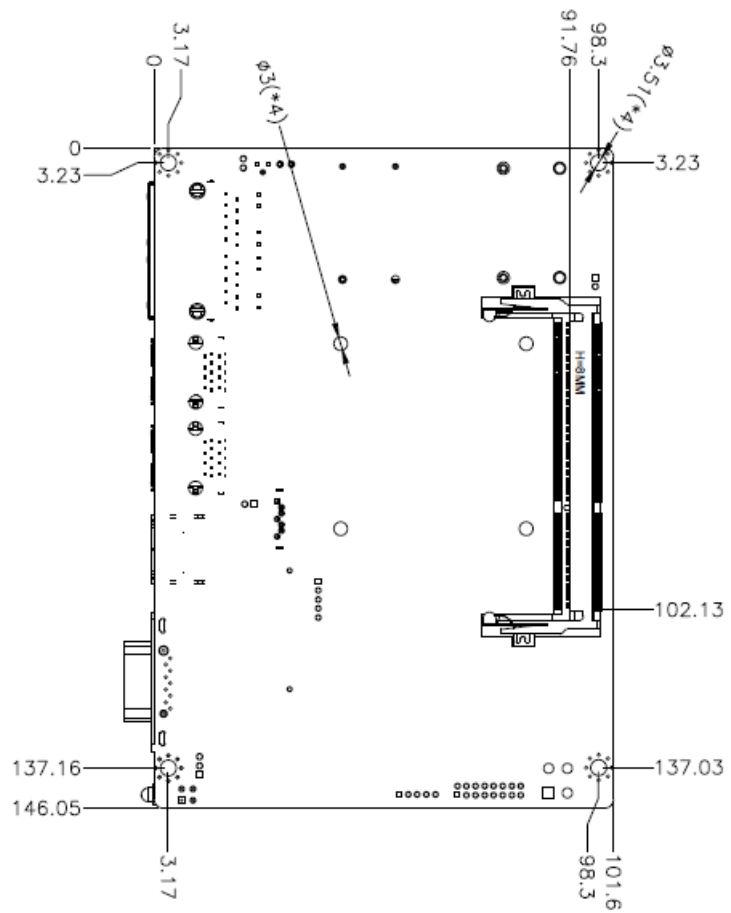

Unit: mm

