

EBM-PNV

Intel® Atom™ Dual-Core 5.25" Mini Module with Intel®
ICH8-M Chipset

User's Manual



1st Ed – 22 August 2011

FCC Statement



THIS DEVICE COMPLIES WITH PART 15 FCC RULES. OPERATION IS SUBJECT TO THE FOLLOWING TWO CONDITIONS:

- (1) THIS DEVICE MAY NOT CAUSE HARMFUL INTERFERENCE.
- (2) THIS DEVICE MUST ACCEPT ANY INTERFERENCE RECEIVED INCLUDING INTERFERENCE THAT MAY CAUSE UNDESIRE OPERATION.

THIS EQUIPMENT HAS BEEN TESTED AND FOUND TO COMPLY WITH THE LIMITS FOR A CLASS "A" DIGITAL DEVICE, PURSUANT TO PART 15 OF THE FCC RULES.

THESE LIMITS ARE DESIGNED TO PROVIDE REASONABLE PROTECTION AGAINST HARMFUL INTERFERENCE WHEN THE EQUIPMENT IS OPERATED IN A COMMERCIAL ENVIRONMENT. THIS EQUIPMENT GENERATES, USES, AND CAN RADIATE RADIO FREQUENCY ENERGY AND, IF NOT INSTALLED AND USED IN ACCORDANCE WITH THE INSTRUCTION MANUAL, MAY CAUSE HARMFUL INTERFERENCE TO RADIO COMMUNICATIONS.

OPERATION OF THIS EQUIPMENT IN A RESIDENTIAL AREA IS LIKELY TO CAUSE HARMFUL INTERFERENCE IN WHICH CASE THE USER WILL BE REQUIRED TO CORRECT THE INTERFERENCE AT HIS OWN EXPENSE.

Notice

This guide is designed for experienced users to setup the system within the shortest time. For detailed information, please always refer to the electronic user's manual.

Copyright Notice

Copyright © 2011 Avalue Technology Inc., ALL RIGHTS RESERVED.

No part of this document may be reproduced, copied, translated, or transmitted in any form or by any means, electronic or mechanical, for any purpose, without the prior written permission of the original manufacturer.

Trademark Acknowledgement

Brand and product names are trademarks or registered trademarks of their respective owners.

Disclaimer

Avalue Technology Inc. reserves the right to make changes, without notice, to any product, including circuits and/or software described or contained in this manual in order to improve design and/or performance. Avalue Technology assumes no responsibility or liability for the use of the described product(s), conveys no license or title under any patent, copyright, or masks work rights to these products, and makes no representations or warranties that

these products are free from patent, copyright, or mask work right infringement, unless otherwise specified. Applications that are described in this manual are for illustration purposes only. Avalue Technology Inc. makes no representation or warranty that such application will be suitable for the specified use without further testing or modification.

Life Support Policy

Avalue Technology's PRODUCTS ARE NOT FOR USE AS CRITICAL COMPONENTS IN LIFE SUPPORT DEVICES OR SYSTEMS WITHOUT THE PRIOR WRITTEN APPROVAL OF Avalue Technology Inc.

As used herein:

1. Life support devices or systems are devices or systems which, (a) are intended for surgical implant into body, or (b) support or sustain life and whose failure to perform, when properly used in accordance with instructions for use provided in the labeling, can be reasonably expected to result in significant injury to the user.
2. A critical component is any component of a life support device or system whose failure to perform can be reasonably expected to cause the failure of the life support device or system, or to affect its safety or effectiveness.

A Message to the Customer

Avalue Customer Services

Each and every Avalue's product is built to the most exacting specifications to ensure reliable performance in the harsh and demanding conditions typical of industrial environments. Whether your new Avalue device is destined for the laboratory or the factory floor, you can be assured that your product will provide the reliability and ease of operation for which the name Avalue has come to be known.

Your satisfaction is our primary concern. Here is a guide to Avalue's customer services. To ensure you get the full benefit of our services, please follow the instructions below carefully.

Technical Support

We want you to get the maximum performance from your products. So if you run into technical difficulties, we are here to help. For the most frequently asked questions, you can easily find answers in your product documentation. These answers are normally a lot more detailed than the ones we can give over the phone. So please consult the user's manual first.

To receive the latest version of the user's manual; please visit our Web site at:

<http://www.avalue.com.tw/>

EBM-PNV User's Manual

If you still cannot find the answer, gather all the information or questions that apply to your problem, and with the product close at hand, call your dealer. Our dealers are well trained and ready to give you the support you need to get the most from your Avalue's products. In fact, most problems reported are minor and are able to be easily solved over the phone. In addition, free technical support is available from Avalue's engineers every business day. We are always ready to give advice on application requirements or specific information on the installation and operation of any of our products. Please do not hesitate to call or e-mail us.

Headquarters and Branch

Avalue Technology Inc.

7F, 228, Lian-cheng Road, Chung Ho City, Taipei,
Taiwan

Tel:+886-2-8226-2345

Fax: +886-2-8226-2777

Information: sales@avalue.com.tw

Service: service@avalue.com.tw

BCM Advanced Research

BCM Advanced Research an Avalue Company

7 Marconi, Irvine, CA92618

Tel: +1-949-470-1888

Fax: +1-949-470-0971

Information: BCMSales@bcmcom.com

Web: www.bcmcom.com

Avalue China

Avalue Technology Inc.

Room 805, Building 9, No.99 Tianzhou Rd.,
Caohejing Development Area,

Xuhui District, Shanghai

Tel: +86-21-5169-3609

Fax: +86-21-5445-3266

Information: sales.china@avalue.com.cn

Service: service@avalue.com.tw

Avalue USA

Avalue Technology Inc.

9 Timber Lane, Marlboro, NJ 07746-1443

Tel: (732) 414-6500

Fax: (732) 414-6501

Information: sales@avalue-usa.com

Service: support@avalue-usa.com

Avalue Europe

Avalue Europe A/S

Moelledalen 22C, 3140

Aalsgaarde, Denmark

Tel: +45-7025-0310

Fax: +45-4975-5026

Information: sales.europe@avalue.com.tw

Service: service.europe@avalue.com.tw

Avalue Japan

Avalue Technology Inc.

2F keduka-Bldg, 2-27-3 Taito,

Taito-Ku, Tokyo 110-0016 Japan

Tel: +81-3-5807-2321

Fax: +81-3-5807-2322

Information: sales.japan@avalue.com.tw

Service: service@avalue.com.tw

Product Warranty

Avalue warrants to you, the original purchaser, that each of its products will be free from defects in materials and workmanship for two years from the date of purchase.

This warranty does not apply to any products that have been repaired or altered by people other than repair personnel authorized by Avalue, or that have been subject of misuse, abuse, accident or improper installation. Avalue assumes no liability under the terms of this warranty as a consequence of such events. Because of Avalue's high quality-control standards and rigorous testing, most of our customers never need to use our repair service. If any of Avalue's products is defective, it will be repaired or replaced at no charge during the warranty period. For out-of-warranty repairs, you will be billed according to the cost of replacement materials, service time, and freight. Please consult your dealer for more details. If you think you have a defective product, follow these steps:

1. Collect all the information about the problem encountered. (For example, CPU type and speed, Avalue's products model name, hardware & BIOS revision number, other hardware and software used, etc.) Note anything abnormal and list any on-screen messages you get when the problem occurs.
2. Call your dealer and describe the problem. Please have your manual, product, and any helpful information available.
3. If your product is diagnosed as defective, obtain an RMA (return material authorization) number from your dealer. This allows us to process your good return more quickly.
4. Carefully pack the defective product, a complete Repair and Replacement Order Card and a photocopy proof of purchase date (such as your sales receipt) in a shippable container. A product returned without proof of the purchase date is not eligible for warranty service.
5. Write the RMA number visibly on the outside of the package and ship it prepaid to your dealer.

Contents

1. Getting Started	9
1.1 Safety Precautions.....	9
1.2 Packing List.....	9
1.3 Document Amendment History	10
1.4 Manual Objectives.....	11
1.5 System Specifications	12
1.6 Architecture Overview – Block Diagram.....	14
2. Hardware Configuration	15
2.1 Product Overview.....	16
2.2 Installation Procedure	17
2.2.1 Main Memory.....	18
2.3 Jumper and Connector List.....	20
2.4 Setting Jumpers & Connectors	22
2.4.1 Clear CMOS (JBAT).....	22
2.4.2 Multi-function select (SW1)	22
2.4.3 Serial port 1/ 2 - RS-232/ 422/ 485 mode select (SW2).....	23
2.4.4 Serial port 1/ 2 pin9 signal select (JRI1/ JRI2)	23
2.4.5 Serial port 1/ 2 RS-232/ 422/ 485 mode select (JP1/ JP2)	24
2.4.6 SATA DOM Pin 7 Power mode selector (JP4).....	24
2.4.7 Battery connector (BAT).....	25
2.4.8 LCD backlight brightness adjustment (JVR1)	26
2.4.9 LCD backlight brightness adjustment (JVR2)	27
2.4.10 Power connector (PWR2)	28
2.4.11 Serial ATA power connector (S_PWR1).....	28
2.4.12 LCD Inverter connector (JBKL1/ JBKL2)	29
2.4.12.1 Signal Description – LCD Inverter Connector (JBKL1/ JBKL2)	29
2.4.13 Optional LPT connector (PRINT).....	30
2.4.14 Serial port 1 connector (COM1)	31
2.4.15 CPU fan connector (CPU_FAN)	32
2.4.16 Audio connector (JAUDIO)	32
2.4.17 Serial port 2 connector (JCOM2)	33
2.4.18 Serial port 3/ 4/ 5/ 6 connector (JCOM3/ JCOM4/ JCOM5/ JCOM6)	34
2.4.19 General purpose I/O connector (JDIO).....	34
2.4.20 LED indicator connector (JLED)	35
2.4.21 LVDS connector (JLVDS1)	36
2.4.21.1 Signal Description – LVDS Connector (JLVDS).....	36

2.4.22	LVDS connector (JLVDS2)	37
2.4.23	Touch panel connector (JTOUCH)	38
2.4.24	USB connector 4&5, 2&3, 6&7 (JUSB1/ JUSB2).....	38
2.4.25	USB connector 9 (JUSB4)	39
2.4.26	OSD for front panel key (JKEY)	39
3.	BIOS Setup	40
3.1	Introduction	41
3.2	Starting Setup	41
3.3	Using Setup	42
3.4	Getting Help	43
3.5	In Case of Problems	43
3.6	BIOS setup	44
3.6.1	Main Menu	44
3.6.1.1	System Time	44
3.6.1.2	System Date	44
3.6.2	Advanced Menu	45
3.6.2.1	CPU Configuration	46
3.6.2.2	IDE Configuration.....	47
3.6.2.2.1	AHCI Configuration.....	48
3.6.2.3	Super I/O Configuration.....	49
3.6.2.4	Hardware Health Configuration	50
3.6.2.5	ACPI Settings.....	50
3.6.2.5.1	General ACPI Configuration.....	51
3.6.2.5.2	Advanced ACPI Configuration	52
3.6.2.5.3	Chipset ACPI Configuration	53
3.6.2.6	USB Configuration	54
3.6.2.7	APM Configuration.....	55
3.6.3	Advanced PCI/ PnP Settings	56
3.6.4	Boot Settings	57
3.6.4.1	Boot Settings Configuration	58
3.6.4.2	Boot Device Priority	59
3.6.4.3	Hard Disk Devices	59
3.6.4.4	Removable Devices	60
3.6.5	Security Settings	60
3.6.5.1	Change Supervisor/ User Password.....	61
3.6.5.2	Clear User Password	62
3.6.5.3	Boot Sector Virus Protection.....	62
3.6.6	Advanced Chipset Settings	63
3.6.6.1	North Bridge Configuration	64
3.6.6.1.1	Video Function Configuration	65

EBM-PNV User's Manual

3.6.6.2	South Bridge Configuration	67
3.6.7	Exit Options	68
3.6.7.1	Save Changes and Exit	68
3.6.7.2	Discard Changes and Exit	69
3.6.7.3	Discard Changes	69
3.6.7.4	Load Optimal Defaults	70
3.6.7.5	Load Failsafe Defaults	70
4.	Drivers Installation.....	71
4.1	Install Chipset Driver (For Intel ICH8-M)	72
4.2	Install Display Driver (For Intel Pineview).....	73
4.3	Install Audio Driver (For Realtek ALC888)	74
4.4	Install Ethernet Driver (For Intel 82574L)	75
5.	Mechanical Drawing	77

1. Getting Started

1.1 Safety Precautions

Warning!



Always completely disconnect the power cord from your chassis whenever you work with the hardware. Do not make connections while the power is on. Sensitive electronic components can be damaged by sudden power surges. Only experienced electronics personnel should open the PC chassis.

Caution!



Always ground yourself to remove any static charge before touching the CPU card. Modern electronic devices are very sensitive to static electric charges. As a safety precaution, use a grounding wrist strap at all times. Place all electronic components in a static-dissipative surface or static-shielded bag when they are not in the chassis.

1.2 Packing List

Before you begin installing your single board, please make sure that the following materials have been shipped:

- 1 x EBM-PNV with Intel® Atom™ Dual Core & DDR3 SDRAM Mini Module
- 1 x DVD-ROM or CD-ROM contains the followings:
 - User's Manual (this manual in PDF file)
 - Ethernet driver and utilities
 - VGA drivers and utilities
 - Audio drivers and utilities



If any of the above items is damaged or missing, contact your retailer.

1.3 Document Amendment History

Revision	Date	Comment
1 st	August 2011	Initial Release

1.4 Manual Objectives

This manual describes in details Avalue Technology EBM-PNV Single Board.





We have tried to include as much information as possible but we have not duplicated information that is already being provided in the standard IBM Technical References, unless it proved to be necessary to aid in the understanding of this board.



We strongly recommend that you study this manual carefully before attempting to interface with EBM-PNV series or change the standard configurations. Whilst all the necessary information is available in this manual we would recommend that unless you are confident, you contact your supplier for guidance.

Please be aware that it is possible to create configurations within the CMOS RAM that make booting impossible. If this should happen, clear the CMOS settings, (see the description of the Jumper Settings for details).

If you have any suggestions or find any errors concerning this manual and want to inform us of these, please contact our Customer Service department with the relevant details.

1.5 System Specifications

System 	
CPU	Onboard Intel® Atom™ D525 Dual-Core 1.8GHz CPU
FSB	800 MHz
BIOS	AMI 8Mbit Flash BIOS
System Chipset	Intel® ICH8-M Chipset (2.4W)
I/O Chip	Winbond W83627DHG-P
System Memory	Onboard 1GB DDR3 SDRAM & One 204-pin SODIMM Supports Up to 3GB DDR3
SSD	One CompactFlash Type I/II Socket
Watchdog Timer	Reset: 1 ~ 255min. and 1sec. or 1min./step
H/W Status Monitor	Monitoring System Temperature, Voltage, and Cooling Fan Status. Auto Trotting Control when CPU Overheats
Expansion	Two Mini PCIe Slots (One Supports <u>optional</u> Mini Card DOM)
I/O 	
MIO	1 x SATA (SATA 2 or SATA 3) optional, 1 LPT (Option), 2 x RS-232/422/485, 4 x RS-232 (Option), 1 x K/B & Mouse (Option)
USB	7 x USB 2.0
DIO	16-bit General Purpose I/O for DI and DO 8-bit Parallel Port Data
Display 	
Chipset	Intel® Pineview™ Integrated, Gen3.5 + GFX Core @ 400MHz
Resolution	CRT Mode : Up to 2048 x 1536 @ 60Hz LCD/ Simultaneous Mode: Up to 1366 x 768 @ 75Hz
Multiple Display	CRT + LVDS, LVDS + LVDS
LVDS	1 x 18-bit, 2 x 18/24-bit LVDS
Backlight Control	VR, PWM (Setting by BIOS)
Touch Screen Interface (Optional) 	
Chipset	ETP-CP-S458XRU
Touch Screen Interface	With 5-pin 2.54mm Pin Header (Can be Selected to Support 4/5-wire Touch Screen)

Audio 	
HD Codec	Realtek ALC888 Supports 5.1-CH Audio
Audio Interface	Mic-in, Line-in, Line-out
Audio Amplifier	2 x 2W
Ethernet 	
LAN 1	Intel® 82574L PCI-E Gigabit Ethernet
LAN 2	Intel® 82574L PCI-E Gigabit Ethernet (Optional 1 x PS/2 Keyboard & Mouse)
Ethernet Interface	1000 Base-Tx Gigabit Ethernet Compatible
Mechanical & Environmental 	
Power Consumption	+12V @ 1.80A
Power Type	+12V ~ +28V Power Input AT/Adapter
Operation Temperature	0 ~ 60°C (32 ~ 140°F)
Operating Humidity	0% ~ 90% Relative Humidity, Non-condensing
Size (L x W)	8" x 5.75" x 0.75" (203mm x 146mm x 19mm)
Weight	0.55lb (0.25kg)

1.6 Architecture Overview – Block Diagram

The following block diagram shows the architecture and main components of EBM-PNV.

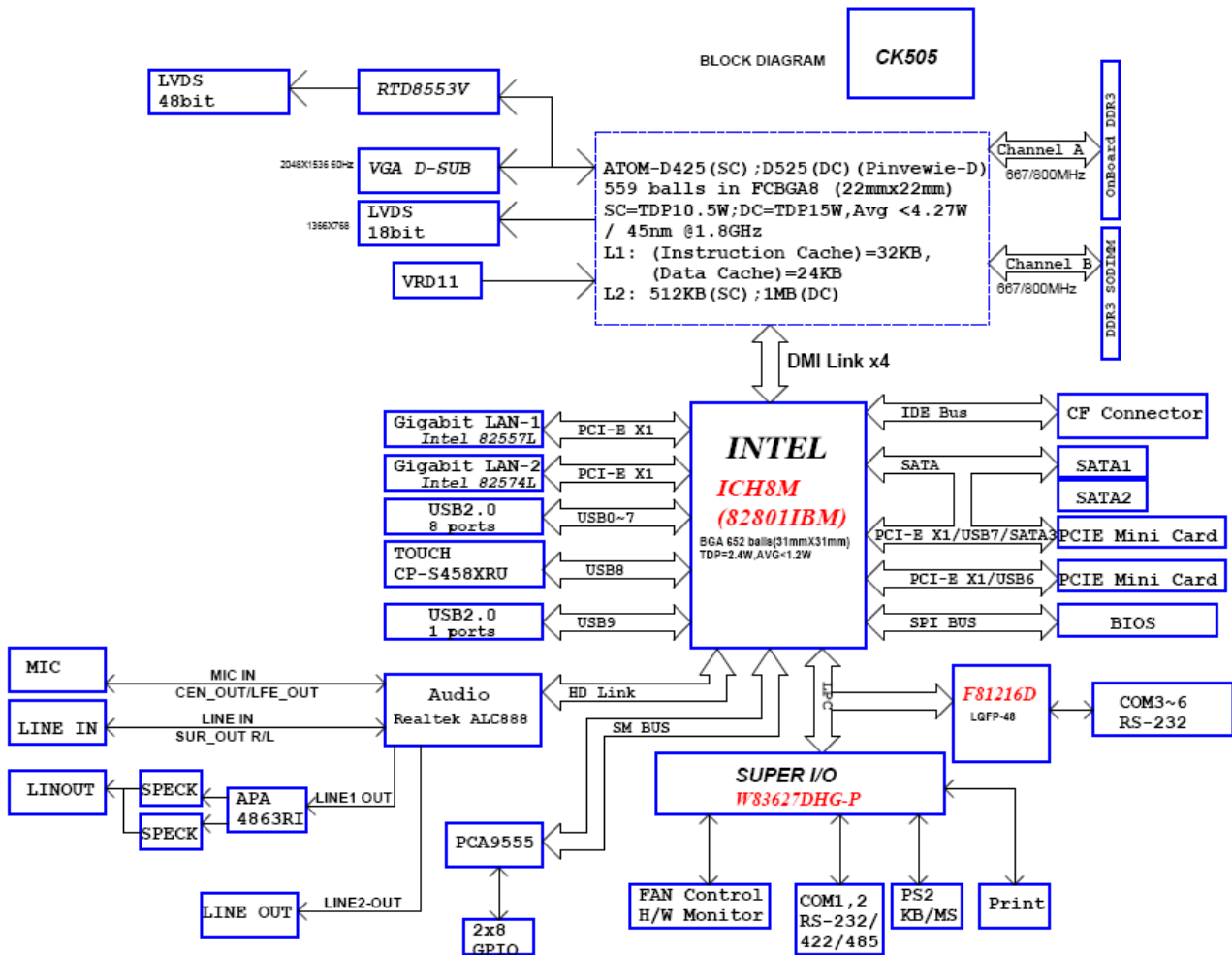

2. Hardware Configuration

2.1 Product Overview

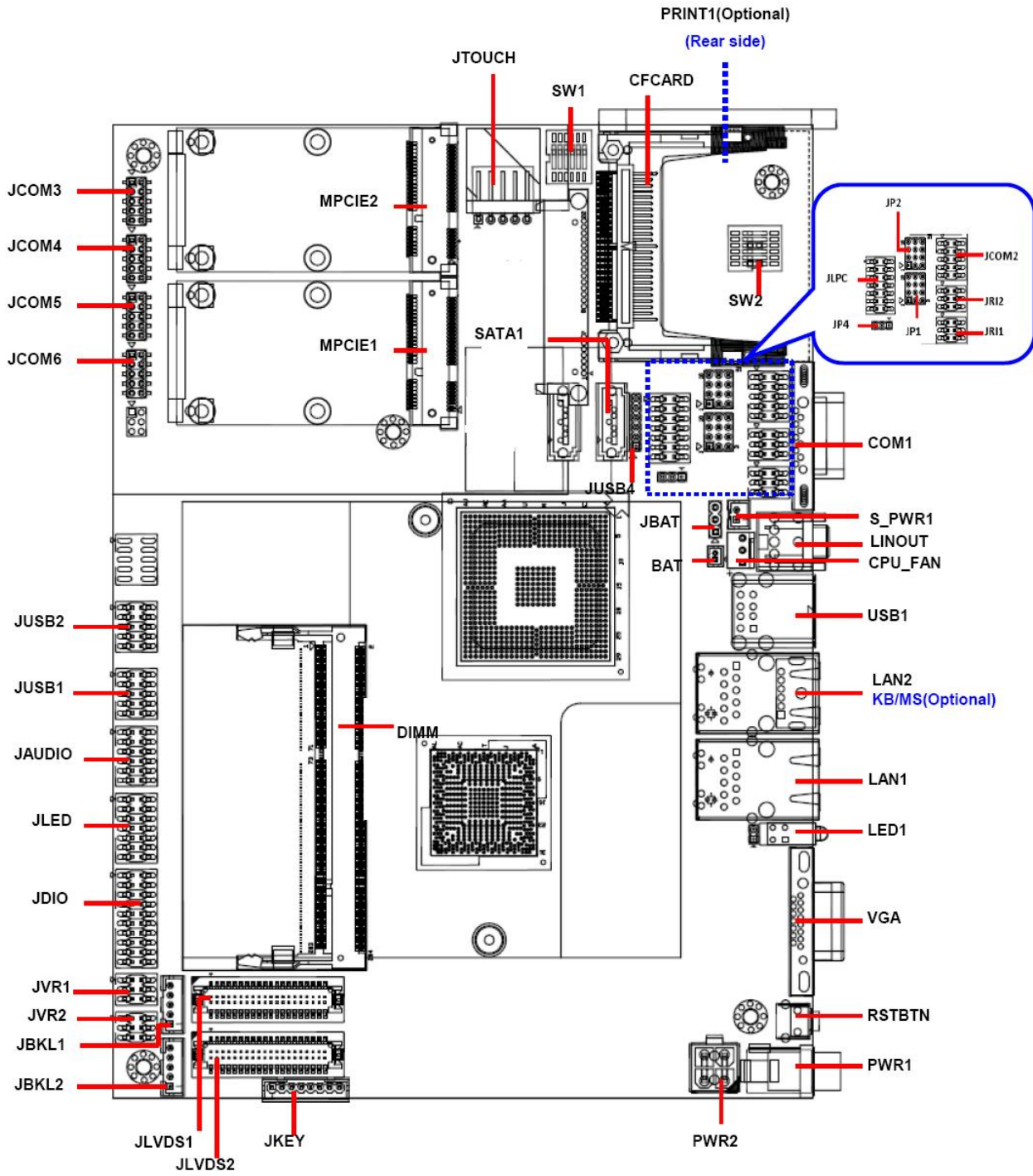

2.2 Installation Procedure

This chapter provides you the instructions on how to setup your system.

1. Turn off the power supply.
2. Insert the SODIMM module (be careful with the orientation).
3. Insert all external cables for hard disk, floppy, keyboard, mouse, USB etc. except for flat panel. A CRT monitor must be connected in order to change CMOS settings to support flat panel.
4. Connect power supply to the board via the ATXPWR.
5. Turn on the power.
6. Enter the BIOS setup by pressing the delete key during boot up. Use the "LOAD BIOS DEFAULTS" feature. The ***Integrated Peripheral Setup*** and the ***Standard CMOS Setup*** Window must be entered and configured correctly to match the particular system configuration.
7. If TFT panel display is to be utilized, make sure the panel voltage is correctly set before connecting the display cable and turning on the power.



Note: Make sure the heat sink and the CPU top surface are in total contact to avoid CPU overheating problem that would cause the system to hang or show instability.

2.2.1 Main Memory

EBM-PNV provides Onboard 1GB DDR3 SDRAM and One 204-pin SODIMM Supporting Up to 3GB DDR3

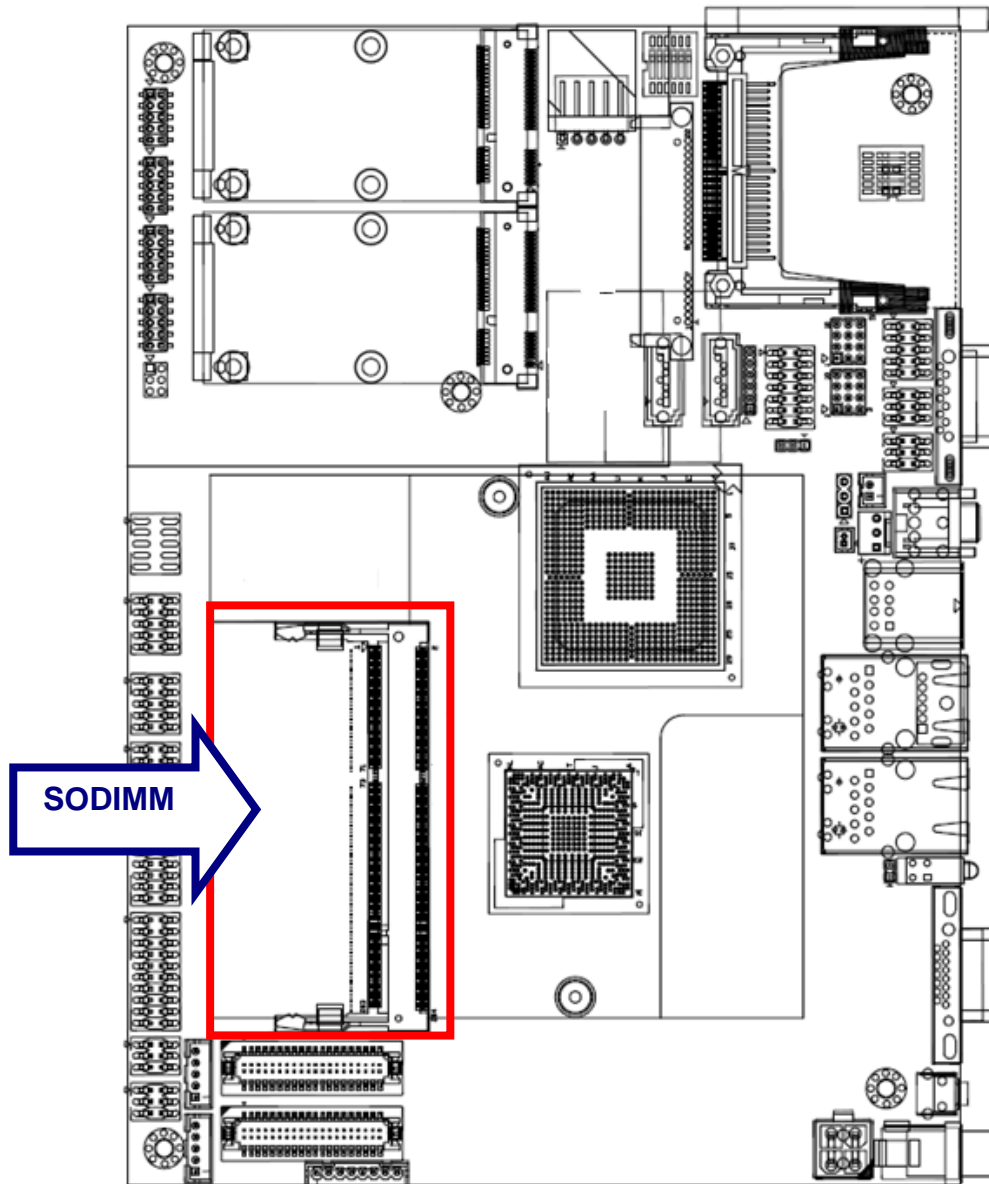

Make sure to unplug the power supply before adding or removing SODIMMs or other system components. Failure to do so may cause severe damage to both the board and the components.

- Locate the SODIMM socket on the board.
- Hold two edges of the SODIMM module carefully. Avoid touching its connectors.

- Align the notch key on the module with the rib on the slot.
- Firmly press the modules into the socket which automatically snaps into the mounting notch. Do not force the SODIMM module in with extra force as the SODIMM module only fits in one direction.

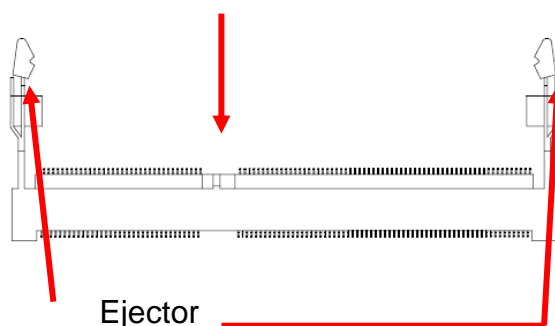
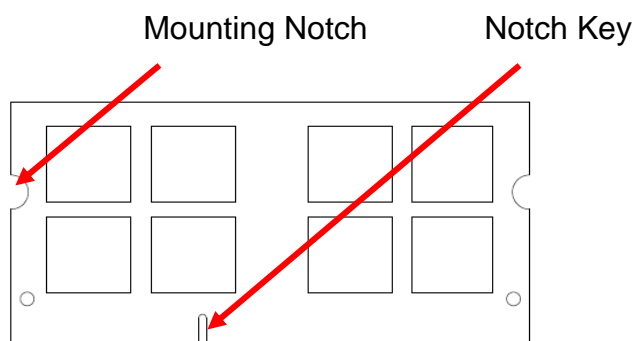

204-pin DDR3 SODIMM

- To remove SODIMM modules, simultaneously push the two ejector tabs outward, then pull out the SODIMM module.



Note:

- (1) Please do not change any DDR3 SDRAM parameter in BIOS setup to increase your system's performance without acquiring technical information in advance.
- (2) Static electricity can damage the electronic components of the computer or optional boards. Before proceeding, ensure that you are discharged of static electricity by briefly touching a grounded metal object.

2.3 Jumper and Connector List

You can configure your board to match the needs of your application by setting jumpers. A jumper is the simplest kind of electric switch.

It consists of two metal pins and a small metal clip (often protected by a plastic cover) that slides over the pins to connect them. To “close” a jumper you connect the pins with the clip. To “open” a jumper you remove the clip. Sometimes a jumper will have three pins, labeled 1, 2, and 3. In this case, you would connect either two pins.

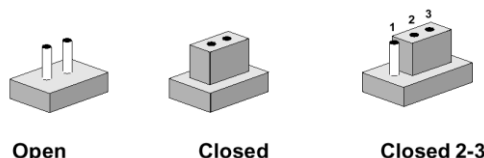

The jumper settings are schematically depicted in this manual as follows:



A pair of needle-nose pliers may be helpful when working with jumpers.

Connectors on the board are linked to external devices such as hard disk drives, a keyboard, or floppy drives. In addition, the board has a number of jumpers that allow you to configure your system to suit your application.

If you have any doubts about the best hardware configuration for your application, contact your local distributor or sales representative before you make any changes.

The following tables list the function of each of the board’s jumpers and connectors.

Jumpers

Label	Function	Note
JBAT	Clear CMOS	3 x 1 header, pitch 2.54mm
JP1	Serial port 1 – RS232/ 422/ 485 mode select	4 x 3 header, pitch 2.0mm
JP2	Serial port 2 – RS232/ 422/ 485 mode select	4 x 3 header, pitch 2.0mm
JP4	SATA DOM Pin 7 Power mode selector	3 x 1 header, pitch 2.0mm
JRI1	Serial port 1 pin9 signal select	3 x 2 header, pitch 2.0mm
JRI2	Serial port 2 pin9 signal select	3 x 2 header, pitch 2.0mm
JVR1	LCD backlight brightness adjustment	3 x 2 header, pitch 2.0mm
JVR2	LCD backlight brightness adjustment	3 x 2 header, pitch 2.0mm
SW1	Multi-function select	DIP switch 6pin
SW2	Serial port 1/ 2 – RS232/ 422/ 485 mode select	DIP switch 6pin

Connectors

Label	Function	Note
BAT	Battery connector	2 x 1 wafer, pitch 1.25mm
CFCARD	Compact Flash card connector	
COM1	Serial Port 1 connector	D-sub 9 pin, male
CPU_FAN	CPU fan connector	3 x 1 wafer, pitch 2.54mm
DIMM	204-pin DDR3 SODIMM socket	
JAUDIO	Audio connector	6 x 2 header, pitch 2.0mm
JBKL1	LCD Inverter connector	5 x 1 wafer, pitch 2.0mm
JBKL2	LCD Inverter connector	5 x 1 wafer, pitch 2.0mm
JCOM2	Serial Port 2 connector	5 x 2 header, pitch 2.0mm
JCOM3	Serial Port 3 connector	5 x 2 header, pitch 2.0mm
JCOM4	Serial Port 4 connector	5 x 2 header, pitch 2.0mm
JCOM5	Serial Port 5 connector	5 x 2 header, pitch 2.0mm
JCOM6	Serial Port 6 connector	5 x 2 header, pitch 2.0mm
JDIO	General purpose I/O connector	10 x 2 header, pitch 2.0mm
JLED	LED indicator connector	7 x 2 header, pitch 2.0mm
JLVDS1	LVDS Connector	DIN 40-pin wafer, pitch 1.25mm
JLVDS2	LVDS Connector	DIN 40-pin wafer, pitch 1.25mm
JTOUCH	Touch panel connector	5 x 1 header, pitch 2.54mm
JUSB1	USB connector 4&5	5 x 2 header, pitch 2.0mm
JUSB2	USB connector 2&3	5 x 2 header, pitch 2.0mm
JUSB4	USB connector 9	6 x 1 header, pitch 2.0mm
JKEY	OSD for front panel key	8 x 1 wafer, pitch 2.0mm
LAN1	RJ-45 Ethernet 1	
LAN2	RJ-45 Ethernet 1 (KB/MS-Optional)	
LED	LED indicator connector	
LINOUT	Audio line-out connector	
MPCIE1	Mini-PCI connector 1	
MPCIE2	Mini-PCI connector 2	
PRINT	Optional LPT Connector	
PWR1	Power connector	
PWR2	Power connector	2 x 2 wafer, pitch 2.0mm
RSBTN	Reset button	
S_PWR1	Serial ATA power connector	2 x 1 wafer, pitch 2.0mm
SATA1	Serial ATA connector 1	
SATA2	Serial ATA connector 2	
USB1	USB connector 0&1	
VGA	VGA connector	D-sub 15-pin, female

2.4 Setting Jumpers & Connectors

2.4.1 Clear CMOS (JBAT)

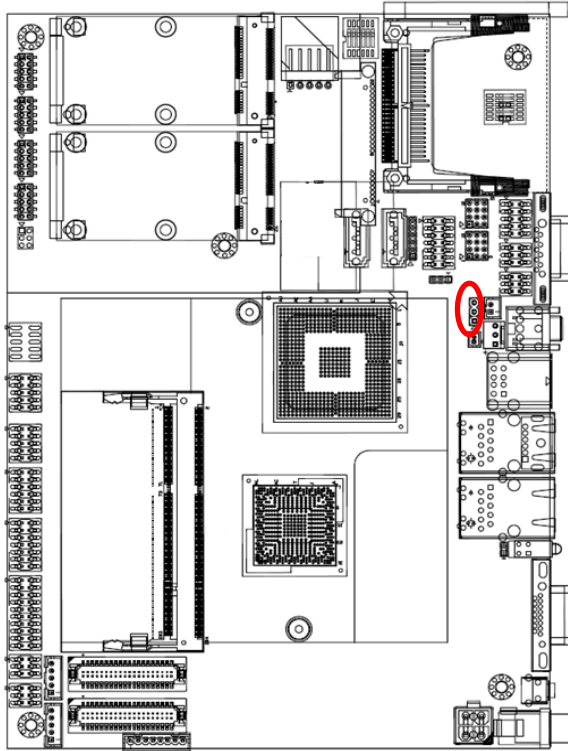

Protect*

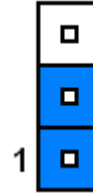

Clear CMOS

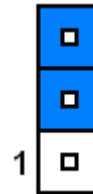

* Default

2.4.2 Multi-function select (SW1)

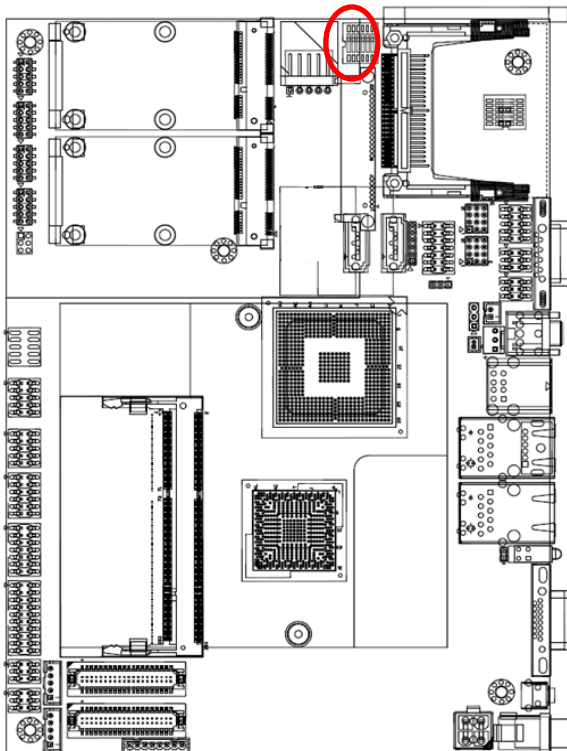

	ON	OFF
1	AT SEL	ATX SEL
2	CF Master	CF Slave
3	Touch off	Touch on
4	Touch: 4W	Touch: 5W
5	GPIO32:L	GPIO32:H
6	GPIO33:L	GPIO33:H

2.4.3 Serial port 1/ 2 - RS-232/ 422/ 485 mode select (SW2)

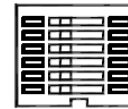
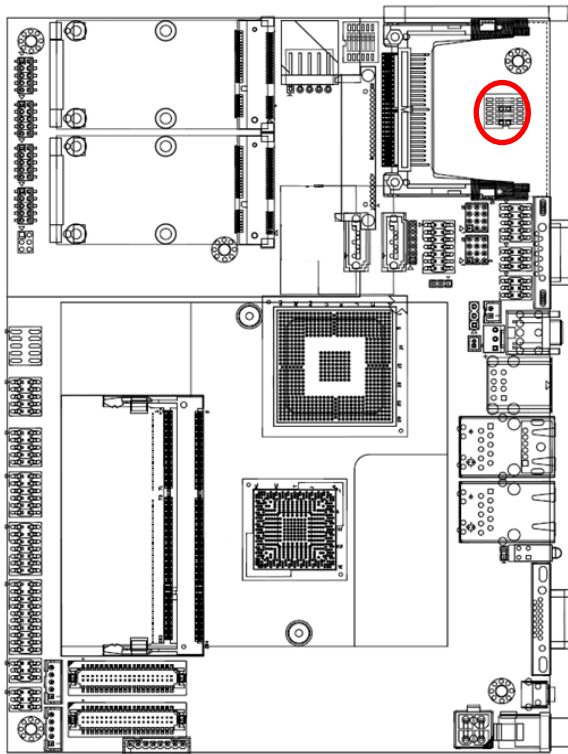

In Serial Port 1 mode

	RS-232	RS-422	RS-485
1	ON	OFF	OFF
2	OFF	ON	OFF
3	OFF	OFF	ON

In Serial Port 2 mode

	RS-232	RS-422	RS-485
4	ON	OFF	OFF
5	OFF	ON	OFF
6	OFF	OFF	ON

2.4.4 Serial port 1/ 2 pin9 signal select (JRI1/ JRI2)

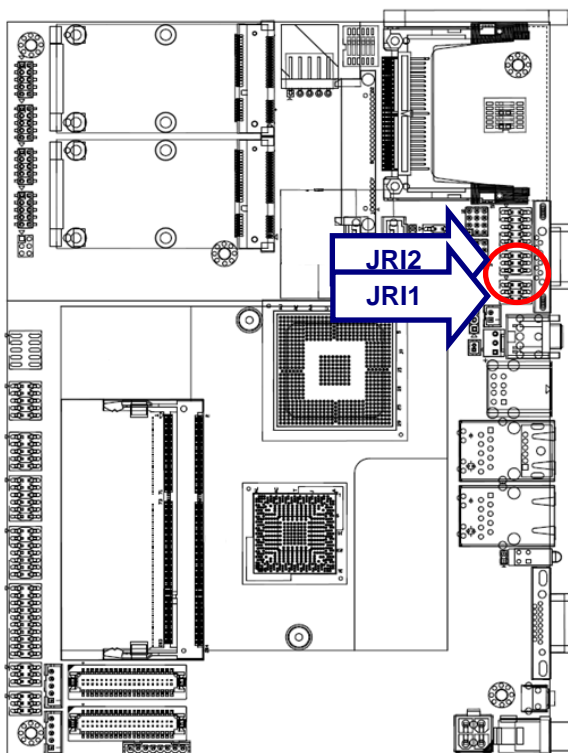

Ring*

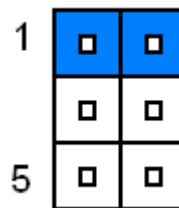

+12V

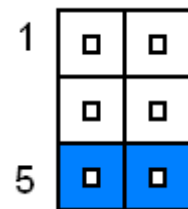

+5V

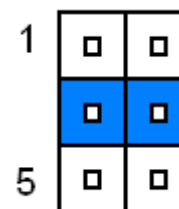

* Default

2.4.5 Serial port 1/ 2 RS-232/ 422/ 485 mode select (JP1/ JP2)

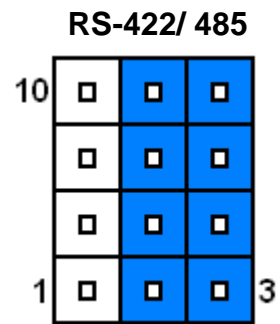
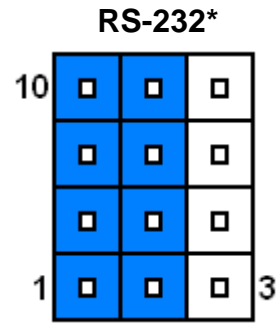
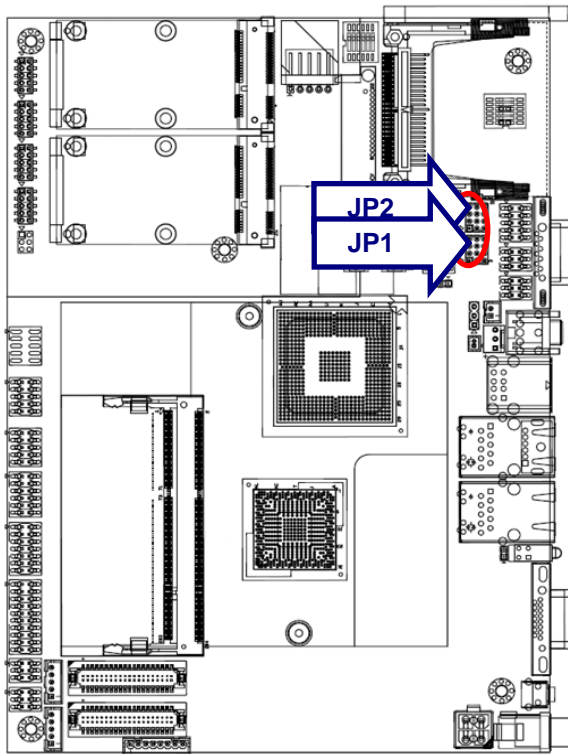

* Default

2.4.6 SATA DOM Pin 7 Power mode selector (JP4)

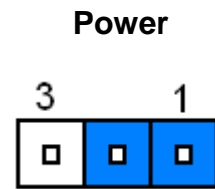
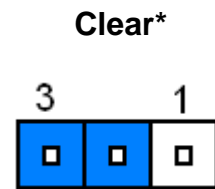
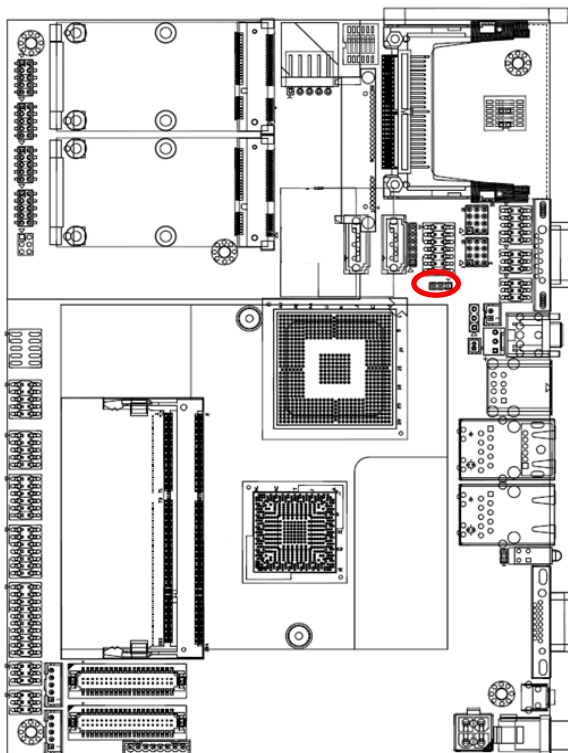

Signal	PIN
SATA_PWR	1
GND#7_1	2
GND	3

* Default

2.4.7 Battery connector (BAT)

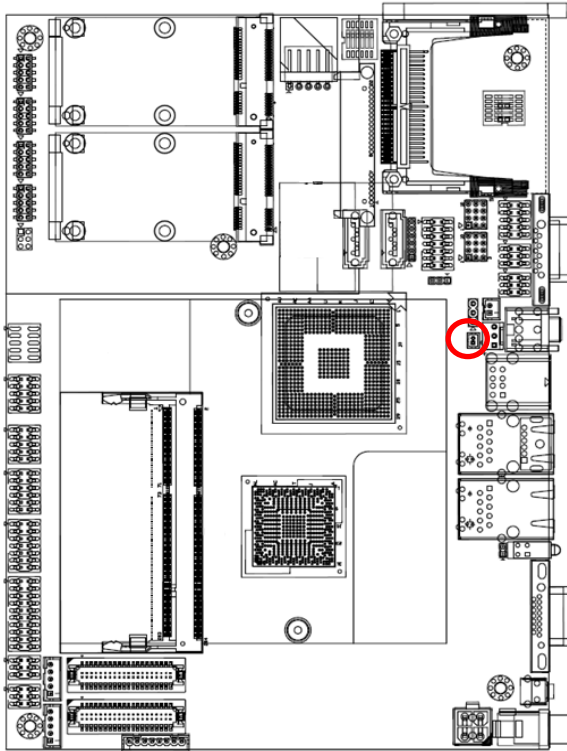

Signal	PIN
GND	2
BAT	1

2.4.8 LCD backlight brightness adjustment (JVR1)

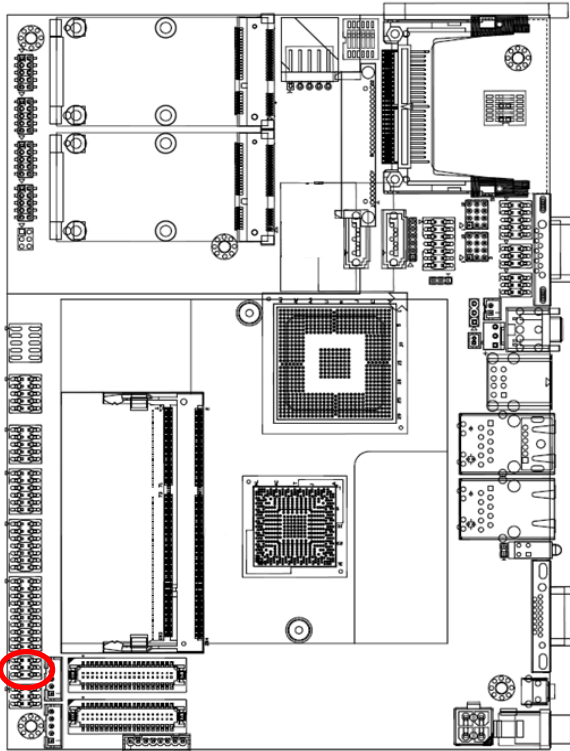

Mode1: VR type

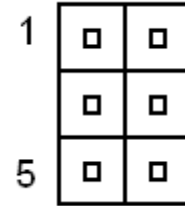

Mode 2: DC type*

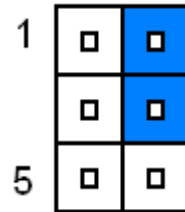

Note: DC: 0V ~5V

* Default

Signal	PIN	PIN	Signal
+5V	1	2	DC
VR	3	4	VR
GND	5	6	PWM

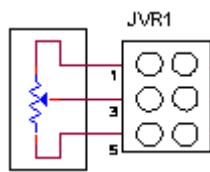

Variation Resistor

(Recommended: 4.7KΩ, >1/16W)

Mode 3: Pulse-Width Modulated type

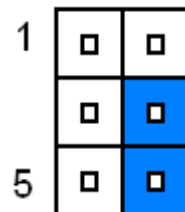

Note:

For inverters with adjustable Backlight function, it is possible to control the LCD brightness through the VR signal controlled by JBKL1. Please see the JBKL1 section for detailed circuitry information.

2.4.9 LCD backlight brightness adjustment (JVR2)

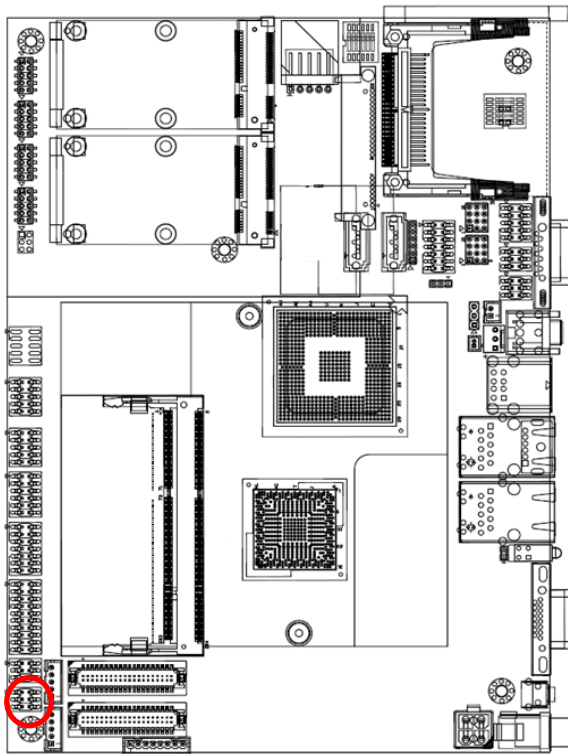

* Default

Mode1: VR type

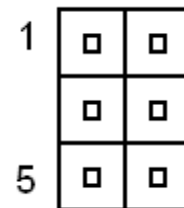

Mode 2: DC type*

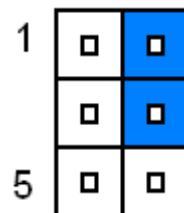

Note: DC: 0V ~5V

Signal	PIN	PIN	Signal
+5V	1	2	DC2
VR	3	4	VR
GND	5	6	PWM2

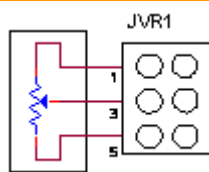

Variation Resistor

(Recommended: 4.7KΩ, >1/16W)

Mode 3: Pulse-Width Modulated type

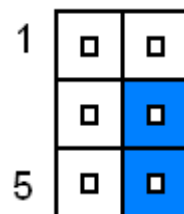

Note:

For inverters with adjustable Backlight function, it is possible to control the LCD brightness through the VR signal controlled by JBKL2. Please see the JBKL2 section for detailed circuitry information.

2.4.10 Power connector (PWR2)

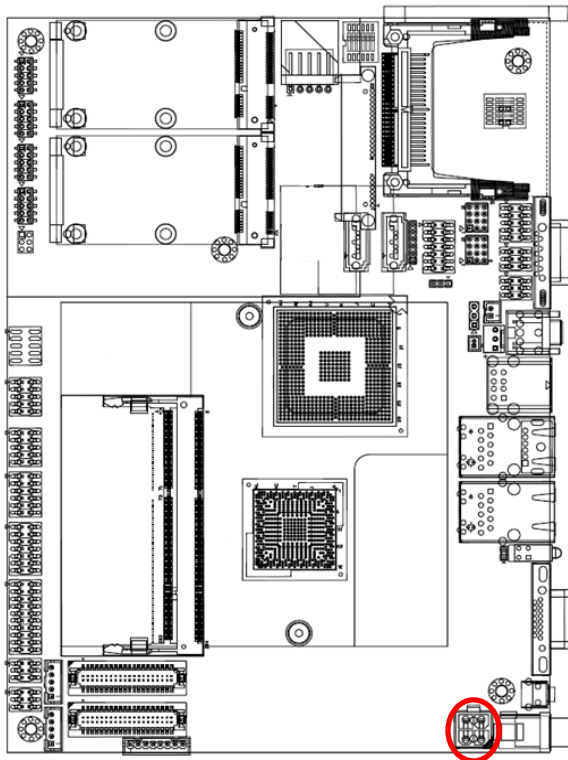

Signal	PIN	PIN	Signal
VIN	4	3	VIN
GND	2	1	GND

2.4.11 Serial ATA power connector (S_PWR1)

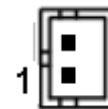
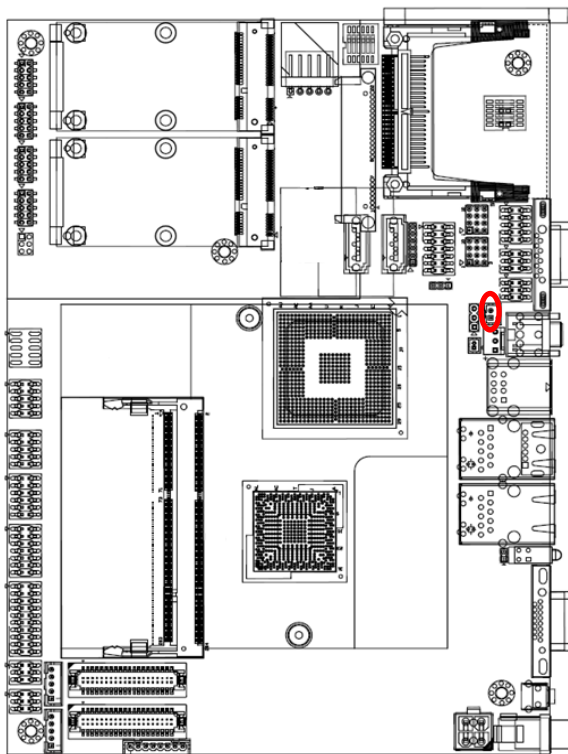

Signal	PIN
SATA_PWR	2
GND	1

2.4.12 LCD Inverter connector (JBKL1/ JBKL2)

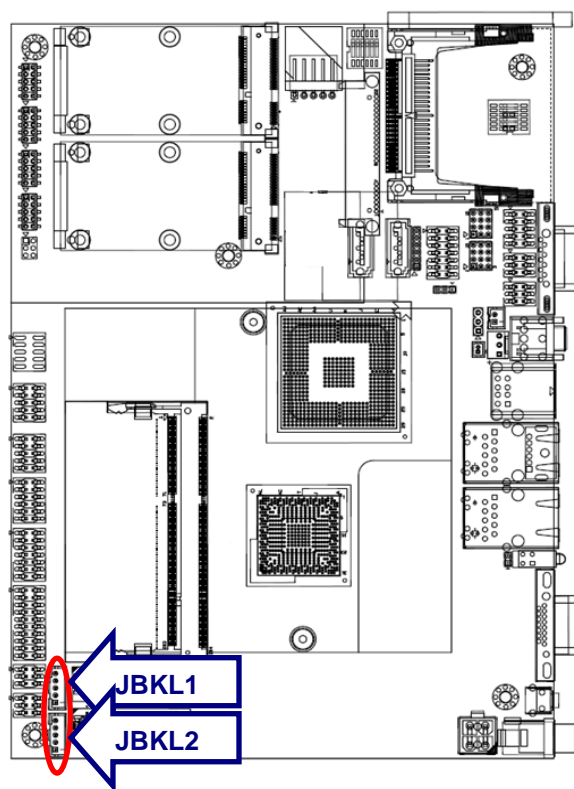

Signal	PIN
+5V	5
BRIGHT	4
BLK_ON	3
GND	2
+12V	1



Note:

For inverters with adjustable Backlight function, it is possible to control the LCD brightness through the VR signal controlled by **JVR1/ JVR2**. Please see the **JVR1/ JVR2** section for detailed circuitry information.

2.4.12.1 Signal Description – LCD Inverter Connector (JBKL1/ JBKL2)

Signal	Signal Description
BRIGHT	Vadj = 0.75V ~ 4.25V (Recommended: 4.7KΩ, >1/16W)
BKL_ON	LCD backlight ON/OFF control signal

2.4.13 Optional LPT connector (PRINT)

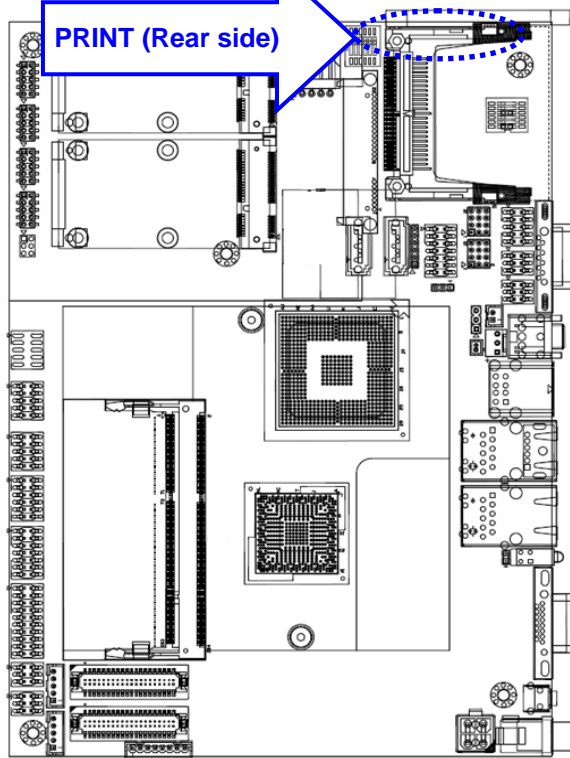

Signal	PIN
GND	20
GND	19
GND	18
SLIN#	17
PAR_INIT#	16
ERR#	15
AFD#	14
SLCT	13
PE	12
BUSY	11
ACK#	10
PTD7	9
PTD6	8
PTD5	7
PTD4	6
PTD3	5
PTD2	4
PTD1	3
PTD0	2
STB-	1

2.4.14 Serial port 1 connector (COM1)

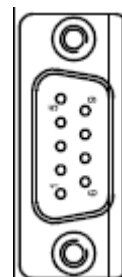
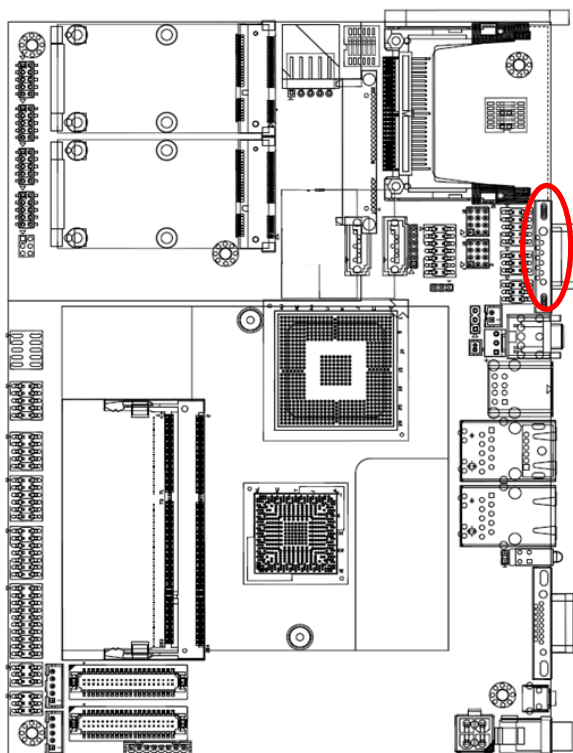

In RS-232 Mode

Signal	PIN	PIN	Signal
DCD1	1	2	RxD1
TxD1	3	4	DTR1
GND	5	6	DSR1
RTS1	7	8	CTS1
RI1	9		NC

In RS-422 Mode

Signal	PIN	PIN	Signal
TxD1-	1	2	RxD1+
TxD1+	3	4	RxD1-
GND	5	6	NC
NC	7	8	NC
NC	9		NC

In RS-485 Mode

Signal	PIN	PIN	Signal
DATA1-	1	2	NC
DATA1+	3	4	NC
GND	5	6	NC
NC	7	8	NC
NC	9		NC

2.4.15 CPU fan connector (CPU_FAN)

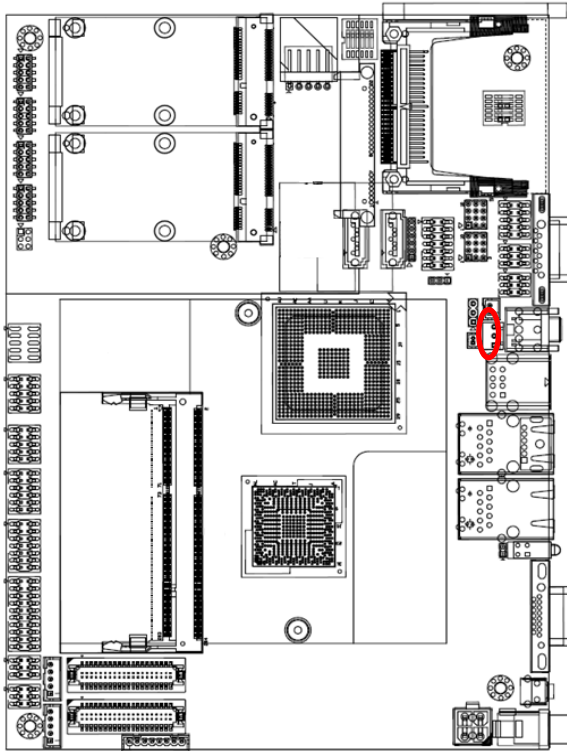

Signal	PIN
FAN_TAC1	3
+12V	2
GND	1

2.4.16 Audio connector (JAUDIO)

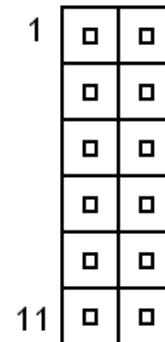
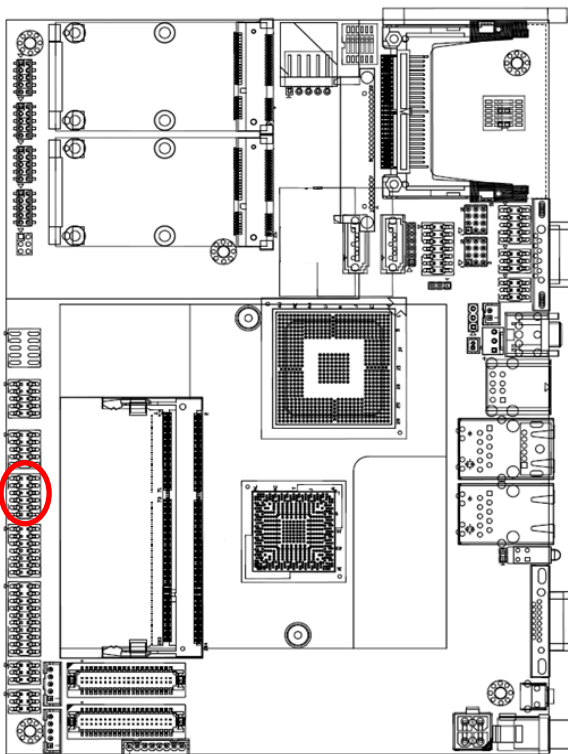

Signal	PIN	PIN	Signal
APM_LOUT_R	1	2	APM_LOUT_L
GND	3	4	GND
LINEIN_R	5	6	LINEIN_L
MIC-R	7	8	MIC-L
FRONT-JD	9	10	LINE1-JD
MIC1-JD	11	12	GND

2.4.17 Serial port 2 connector (JCOM2)

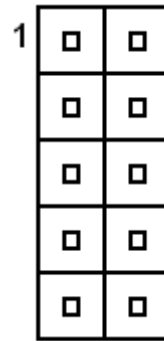
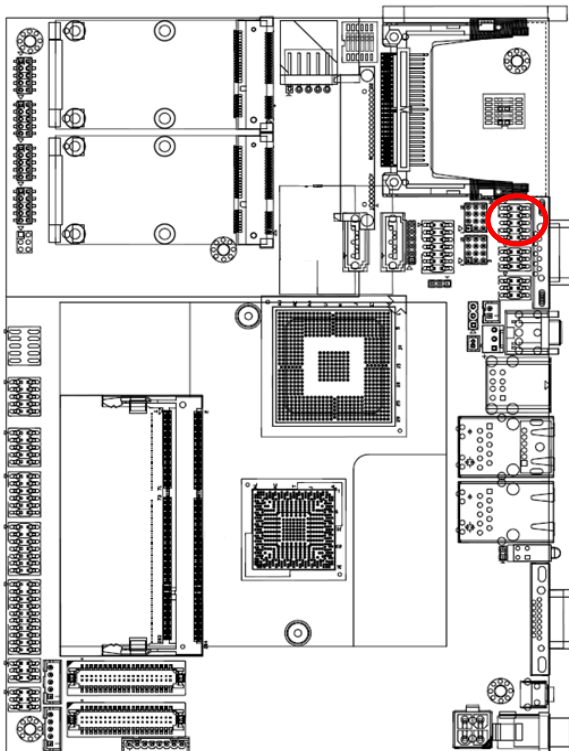

In RS-232 Mode

Signal	PIN	PIN	Signal
DCD2	1	2	RxD2
TxD2	3	4	DTR2
GND	5	6	DSR2
RTS2	7	8	CTS2
RI2	9	10	NC

In RS-422 Mode

Signal	PIN	PIN	Signal
TxD2-	1	2	RxD2+
TxD2+	3	4	RxD2-
GND	5	6	NC
NC	7	8	NC
NC	9	10	NC

In RS-485 Mode

Signal	PIN	PIN	Signal
DATA2-	1	2	NC
DATA2+	3	4	NC
GND	5	6	NC
NC	7	8	NC
NC	9	10	NC

2.4.18 Serial port 3/ 4/ 5/ 6 connector (JCOM3/ JCOM4/ JCOM5/ JCOM6)

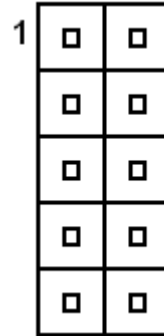
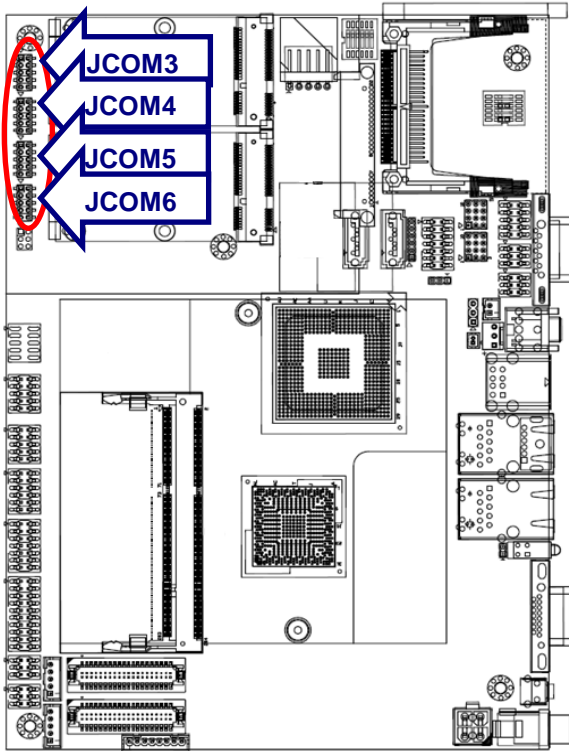

Signal	PIN	PIN	Signal
DCD	1	2	RxD
TxD	3	4	DTR
GND	5	6	DSR
RTS	7	8	CTS
RI	9	10	NC

2.4.19 General purpose I/O connector (JDIO)

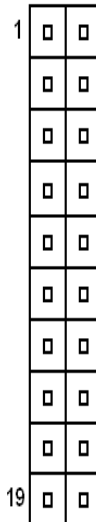
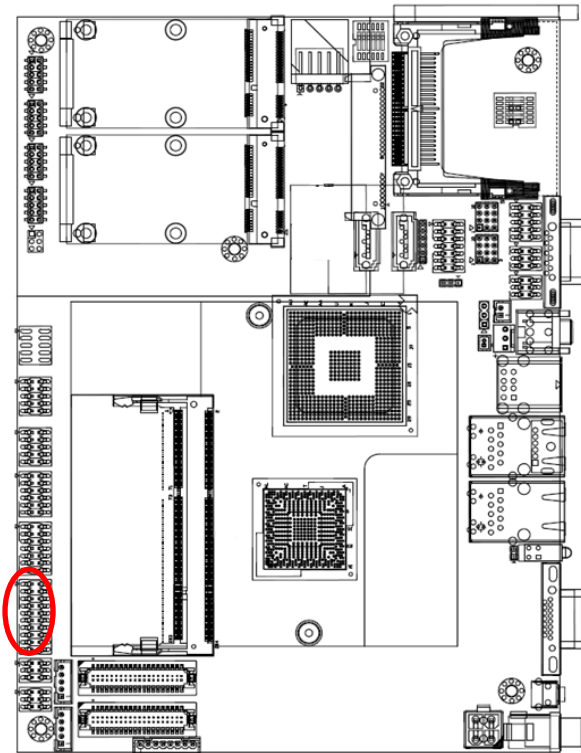

Signal	PIN	PIN	Signal
DIO0	1	2	DIO10
DIO1	3	4	DIO11
DIO2	5	6	DIO12
DIO3	7	8	DIO13
DIO4	9	10	DIO14
DIO5	11	12	DIO15
DIO6	13	14	DIO16
DIO7	15	16	DIO17
SMB_CLK_S	17	18	SMB_DATA_S
GND	19	20	+5V

2.4.20 LED indicator connector (JLED)

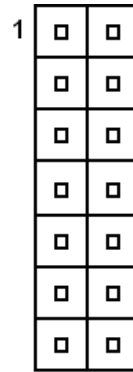
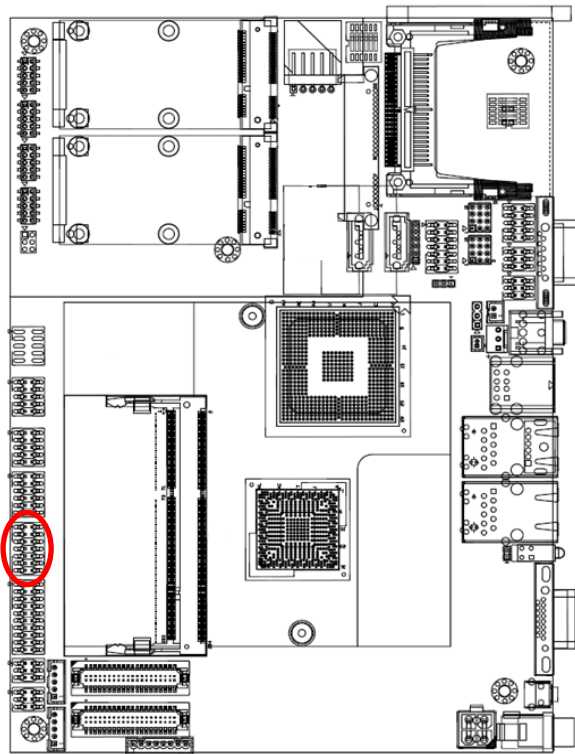

Signal	PIN	PIN	Signal
GND	1	2	+3.3V
HD_ACT#	3	4	+3.3V
LAN1_ACT	5	6	3.3V_SB
LAN2_ACT	7	8	3.3V_SB
ROUT-	9	10	ROUT+
LOUT-	11	12	LOUT+
PWRBTN#	13	14	GND

2.4.21 LVDS connector (JLVDS1)

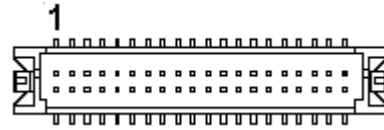
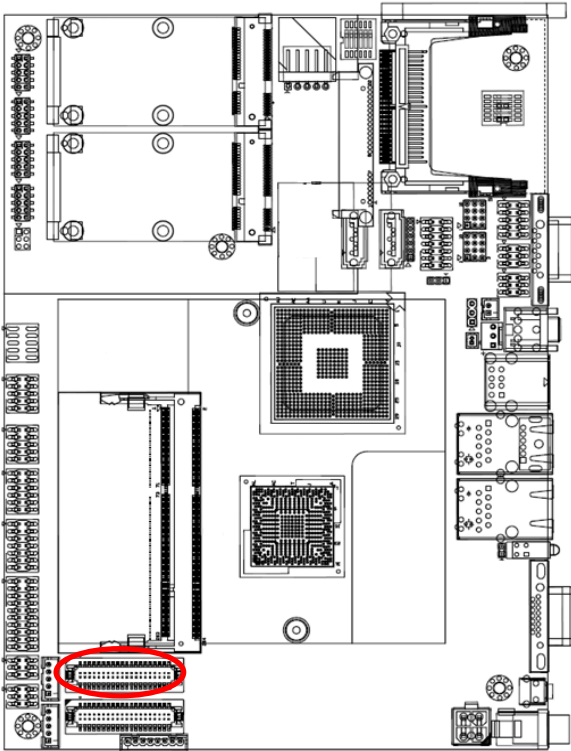

Signal	PIN	PIN	Signal
+5V	2	1	+3.3V
+5V	4	3	+3.3V
I ² C_DAT	6	5	I ² C_CLK
GND	8	7	GND
Txout0	10	9	Txout1
Txout0#	12	11	Txout1#
GND	14	13	GND
Txout2	16	15	NC
Txout2#	18	17	NC
GND	20	19	GND
NC	22	21	NC
NC	24	23	NC
GND	26	25	GND
NC	28	27	NC
NC	30	29	NC
GND	32	31	GND
Txclk	34	33	NC
Txclk#	36	35	NC
GND	38	37	GND
+12V	40	39	+12V

2.4.21.1 Signal Description – LVDS Connector (JLVDS)

Signal	Description
I ² C_DAT, I ² C_CLK	I ² C interface for panel parameter EEPROM. This EEPROM is mounted on the LVDS receiver. The data in the EEPROM allows the EXT module to automatically set the proper timing parameters for a specific LCD panel.

2.4.22 LVDS connector (JLVDS2)

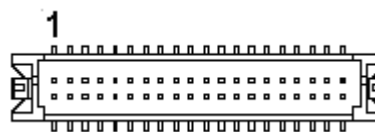
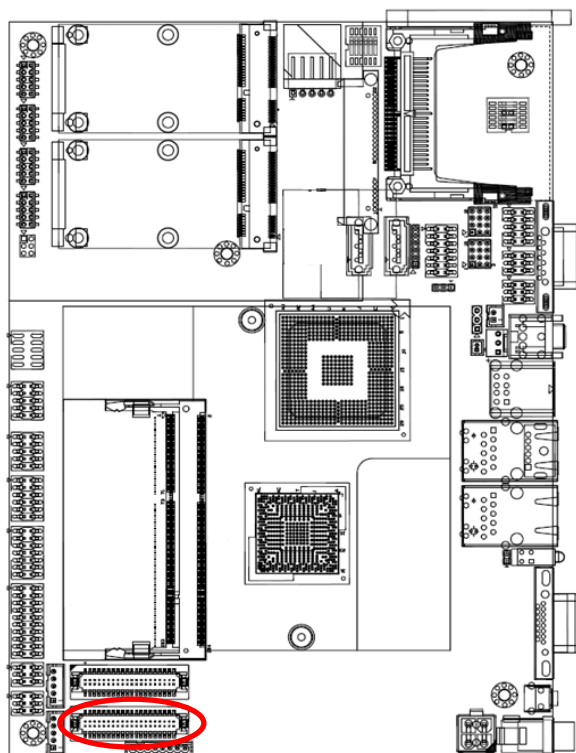

Signal	PIN	PIN	Signal
+5V	2	1	+3.3V
+5V	4	3	+3.3V
NC	6	5	NC
GND	8	7	GND
Txout0	10	9	Txout1
Txout0#	12	11	Txout1#
GND	14	13	GND
Txout2	16	15	Txout3
Txout2#	18	17	Txout3#
GND	20	19	GND
Txout4	22	21	Txout5
Txout4#	24	23	Txout5#
GND	26	25	GND
Txout6	28	27	Txout7
Txout6#	30	29	Txout7#
GND	32	31	GND
Txclk1	34	33	Txclk2
Txclk1#	36	35	Txclk2#
GND	38	37	GND
+12V	40	39	+12V



Note: Single/Dual 24-bit LVDS

- CRT's resolution < LCD's resolution.

If we boot from CRT & LCD, the resolution is fixed by CRT's resolution.

If we boot from LCD only and plug the CRT in the OS, LCD works well but the CRT will have wrong resolution.
- CRT's resolution > LCD's resolution.

Everything is fine.

2.4.23 Touch panel connector (JTOUCH)

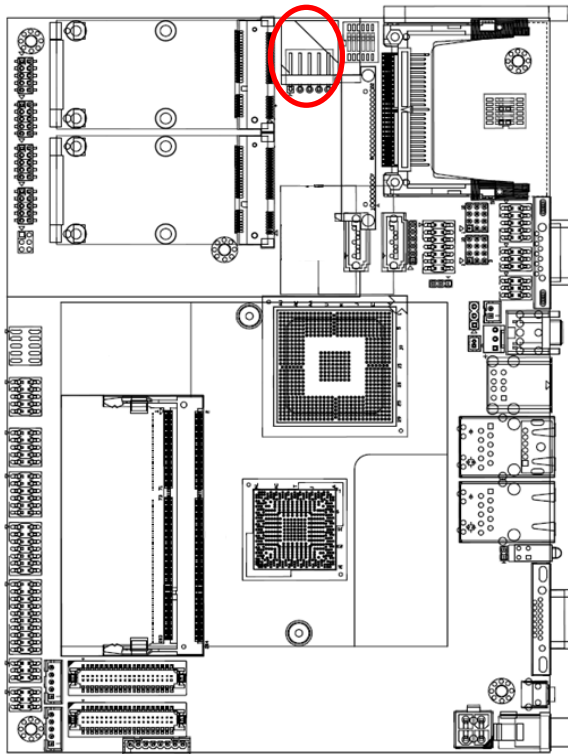

Signal	PIN
UL	1
UR	2
PROBE	3
LR	4
LL	5



NOTE: Under 4W situation
UL=X+, UR=Y+, LR=Y-, LL=X-

2.4.24 USB connector 4&5, 2&3, 6&7 (JUSB1/ JUSB2)

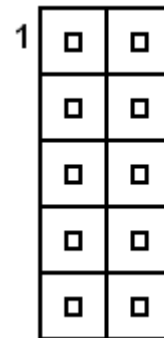
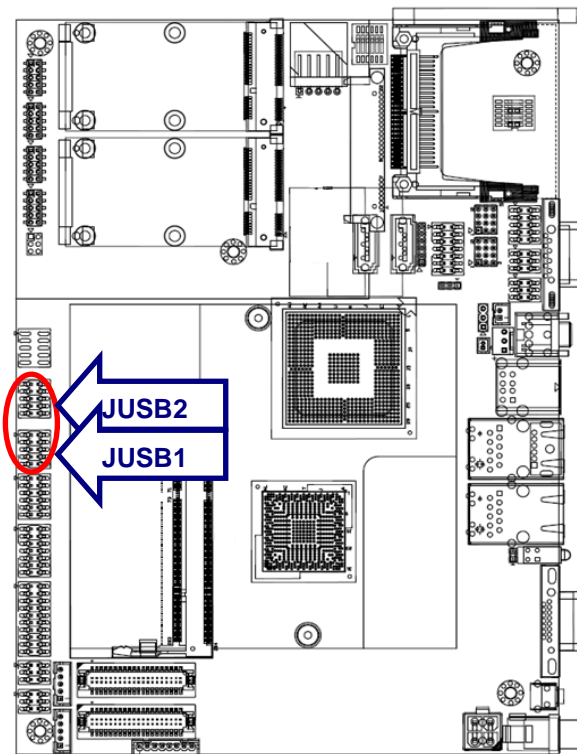

Signal	PIN	PIN	Signal
+5V	1	2	GND
D-	3	4	GND
D+	5	6	D+
GND	7	8	D-
GND	9	10	+5V

2.4.25 USB connector 9 (JUSB4)

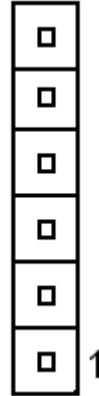
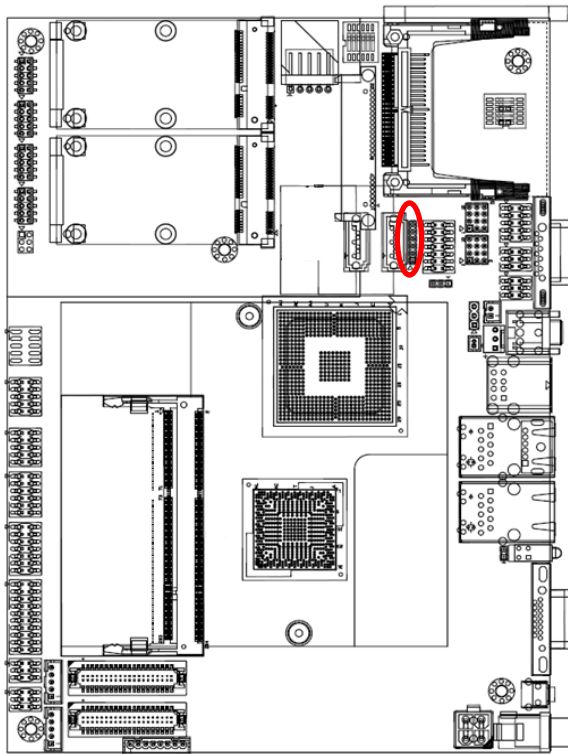

Signal	PIN
+5V	1
D-	2
D+	3
GND	4
GND	5
+3.3V	6

2.4.26 OSD for front panel key (JKEY)

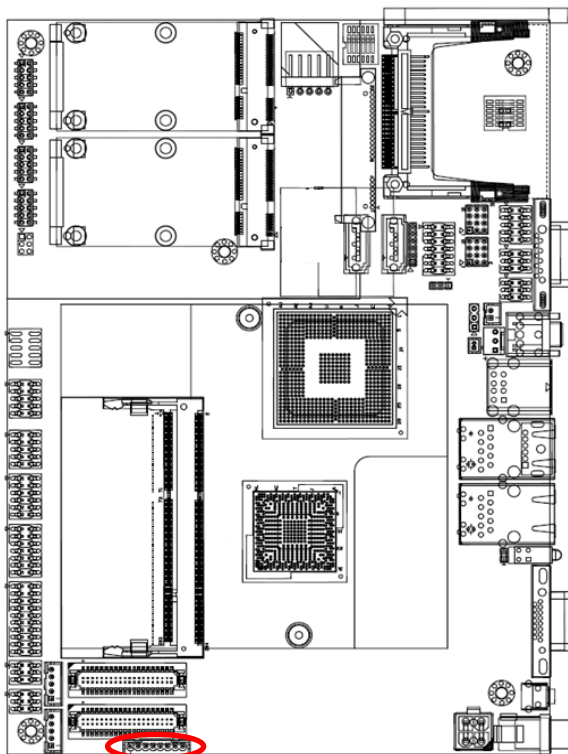

Signal	PIN
GND	1
K-LED_GREEN	2
K-LED_RED	3
K-POWER	4
K-AUTO	5
K-MENU	6
K-RIGHT	7
K-LEFT	8

3. BIOS Setup

3.1 Introduction

The BIOS setup program allows users to modify the basic system configuration. In this following chapter will describe how to access the BIOS setup program and the configuration options that may be changed.

3.2 Starting Setup

The AMI BIOS™ is immediately activated when you first power on the computer. The BIOS reads the system information contained in the CMOS and begins the process of checking out the system and configuring it. When it finishes, the BIOS will seek an operating system on one of the disks and then launch and turn control over to the operating system.

While the BIOS is in control, the Setup program can be activated in one of two ways:

By pressing immediately after switching the system on, or

By pressing the key when the following message appears briefly at the bottom of the screen during the POST (Power On Self Test).

Press DEL to enter SETUP

If the message disappears before you respond and you still wish to enter Setup, restart the system to try again by turning it OFF then ON or pressing the "RESET" button on the system case. You may also restart by simultaneously pressing <Ctrl>, <Alt>, and <Delete> keys. If you do not press the keys at the correct time and the system does not boot, an error message will be displayed and you will again be asked to.

Press F1 to Continue, DEL to enter SETUP

3.3 Using Setup

In general, you use the arrow keys to highlight items, press <Enter> to select, use the PageUp and PageDown keys to change entries, press <F1> for help and press <Esc> to quit. The following table provides more detail about how to navigate in the Setup program using the keyboard.

Button	Description
↑	Move to previous item
↓	Move to next item
←	Move to the item in the left hand
→	Move to the item in the right hand
Esc key	Main Menu -- Quit and not save changes into CMOS Status Page Setup Menu and Option Page Setup Menu -- Exit current page and return to Main Menu
PgUp key	Increase the numeric value or make changes
PgDn key	Decrease the numeric value or make changes
+ key	Increase the numeric value or make changes
- key	Decrease the numeric value or make changes
F1 key	General help, only for Status Page Setup Menu and Option Page Setup Menu
(Shift) F2 key	Change color from total 16 colors. F2 to select color forward, (Shift) F2 to select color backward
F3 key	Calendar, only for Status Page Setup Menu
F4 key	Reserved
F5 key	Restore the previous CMOS value from CMOS, only for Option Page Setup Menu
F6 key	Load the default CMOS value from BIOS default table, only for Option Page Setup Menu
F7 key	Load the default
F8 key	Reserved
F9 key	Reserved
F10 key	Save all the CMOS changes, only for Main Menu

- **Navigating Through The Menu Bar**

Use the left and right arrow keys to choose the menu you want to be in.



Note: Some of the navigation keys differ from one screen to another.

- **To Display a Sub Menu**

Use the arrow keys to move the cursor to the sub menu you want. Then press <Enter>. A “>” pointer marks all sub menus.

3.4 Getting Help

Press F1 to pop up a small help window that describes the appropriate keys to use and the possible selections for the highlighted item. To exit the Help Window press <Esc> or the F1 key again.

3.5 In Case of Problems

If, after making and saving system changes with Setup, you discover that your computer is no longer able to boot, the AMI BIOS supports an override to the CMOS settings which resets your system to its defaults.

The best advice is to only alter settings which you thoroughly understand. To this end, we strongly recommend that you avoid making any changes to the chipset defaults. These defaults have been carefully chosen by both Award and your systems manufacturer to provide the absolute maximum performance and reliability. Even a seemingly small change to the chipset setup has the potential for causing you to use the override.

3.6 BIOS setup

Once you enter the AMI BIOS CMOS Setup Utility, the Main Menu will appear on the screen. The Main Menu allows you to select from several setup functions and exit choices. Use the arrow keys to select among the items and press <Enter> to accept and enter the sub-menu.

3.6.1 Main Menu

This section allows you to record some basic hardware configurations in your computer and set the system clock.

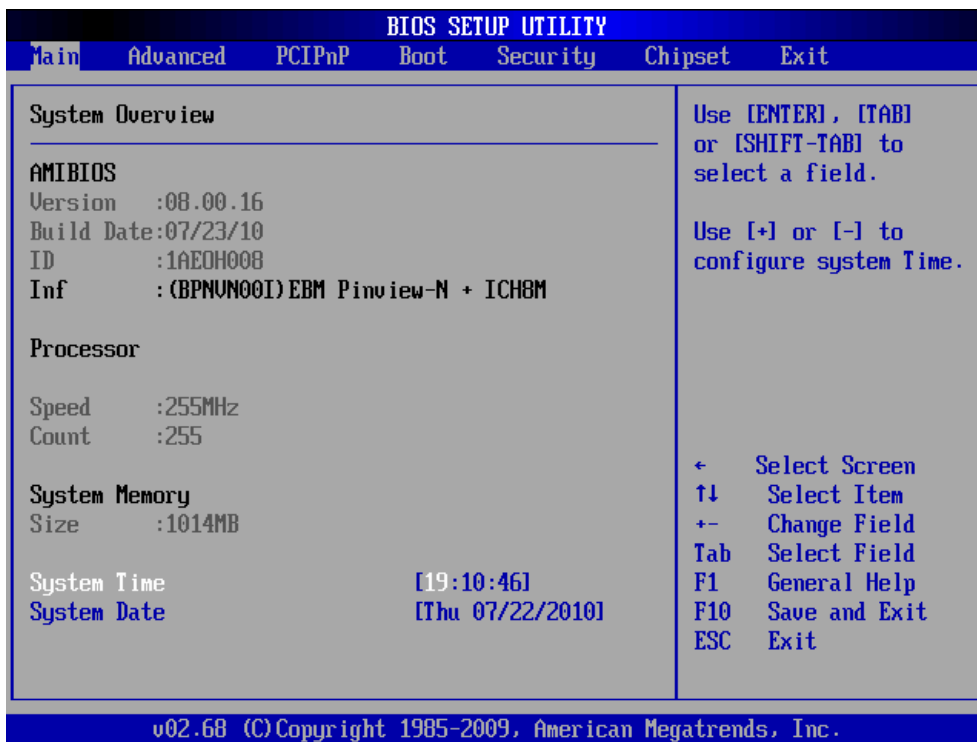

3.6.1.1 System Time

Use the system Date option to set the system date. Manually enter the day, month and year.

3.6.1.2 System Date

Use the system time option to set the system time. Manually enter the hours, minutes and seconds.



Note: The BIOS setup screens shown in this chapter are for reference purposes only, and may not exactly match what you see on your screen. Visit the Avalue website (www.avalue.com.tw) to download the latest product and BIOS information.

3.6.2 Advanced Menu

This section allows you to configure your CPU and other system devices for basic operation through the following sub-menus.

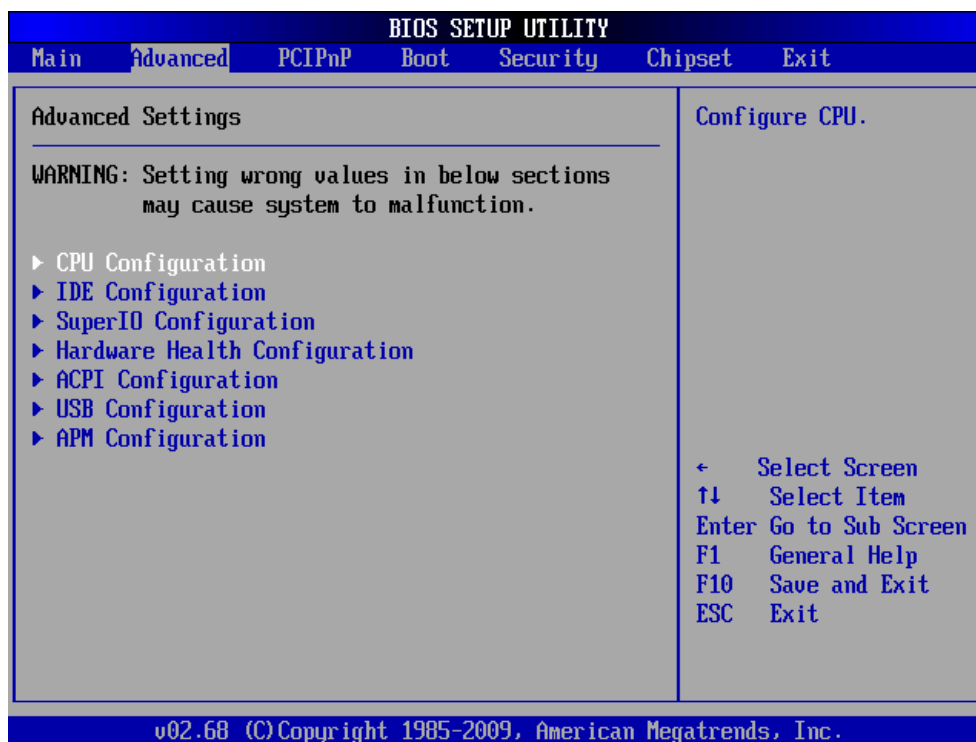

3.6.2.1 CPU Configuration

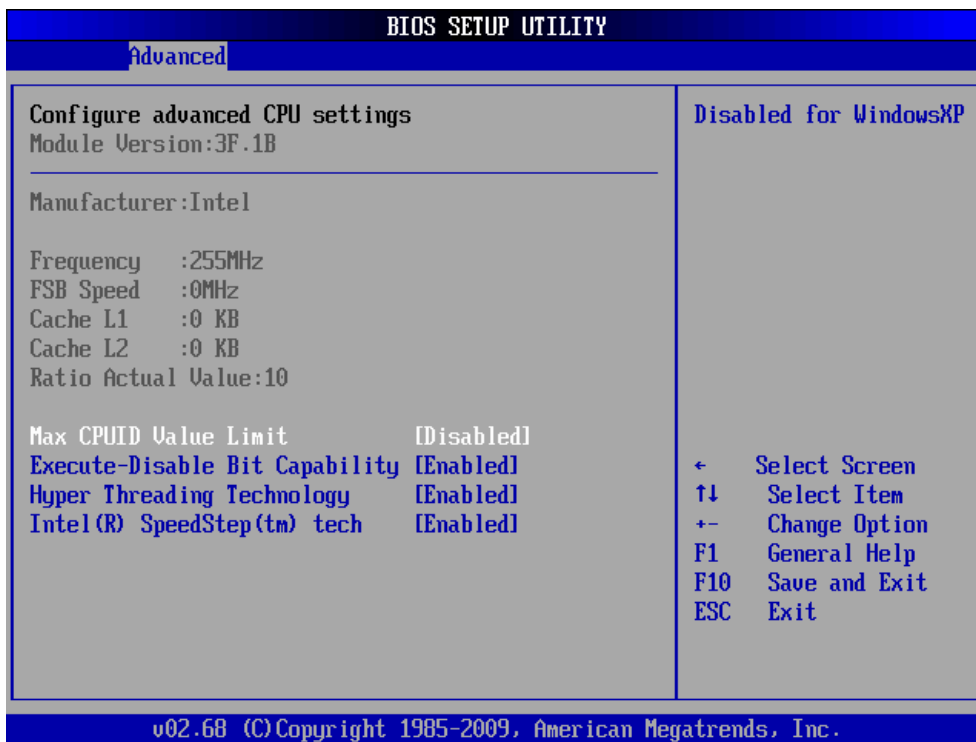

Item	Options	Description
Max CPUID Value Limit	Disabled, Enabled	This item allows you to limit CPUID maximum value.
Execute-Disable Bit Capability	Disabled, Enabled	This item allows you to enable or disable the No-Execution page protection technology.
Hyper Threading Technology	Disabled, Enabled	This item allows you to enable or disable Intel® Hyper Threading technology.
Intel® SpeedStep™ tech	Disabled, Enabled	This item allows you to enable or disable Intel® SpeedStep™ tech.

3.6.2.2 IDE Configuration

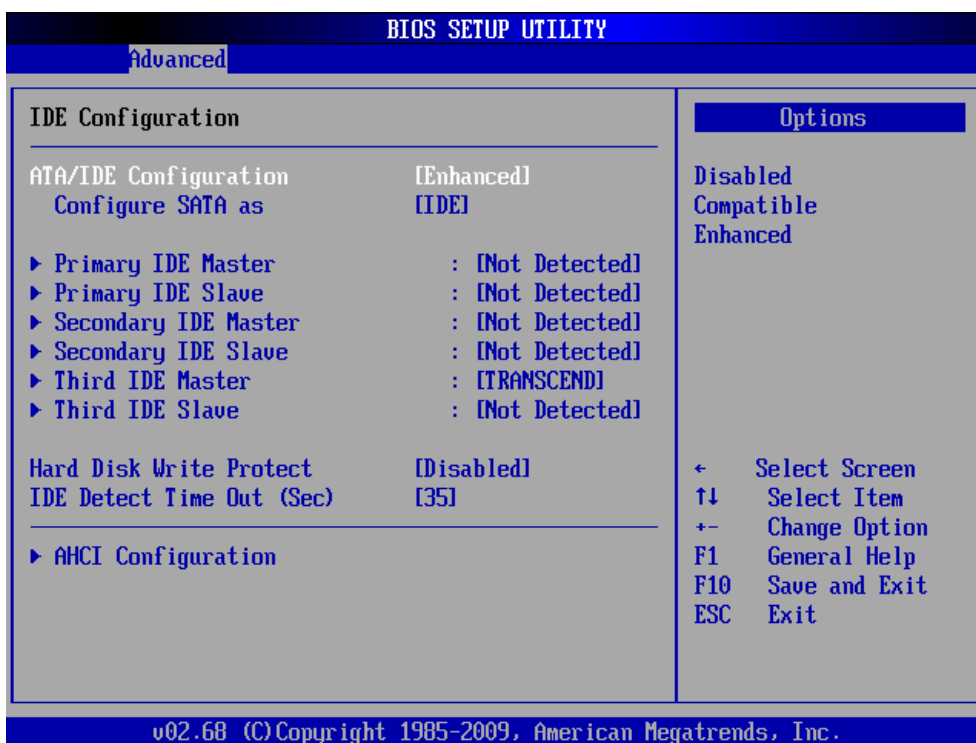

Item	Options	Description
ATA/ IDE Configuration	Disabled, Compatible, Enhanced	This can be configured as Disabled, Compatible or Enhanced.
Configure SATA as	IDE, RAID, AHCI	Use the configure SATA as BIOS option to configure the SATA port as an IDE drive, a SATA drive (AHCI mode) or a SATA drive in a RAID configuration.
Primary/ Secondary/ Third IDE Master	Disabled, Enabled	Use the IDE Master and IDE Slave configuration menu to view both primary and secondary IDE device details and configure the IDE devices connected to the system.
Primary/ Secondary/ Third IDE Slave	Disabled, Enabled	Use the IDE Master and IDE Slave configuration menu to view both primary and secondary IDE device details and configure the IDE devices connected to the system.
Hard Disk Write Protect	Disabled, Enabled	Disable/ Enable device write protection. This will effective only if device is accessed through BIOS.
IDE Detect Time Out (Sec)	0/ 5/ 10/ 15/ 20/ 25/ 30/ 35	This allows you to select the time out value for detecting ATA/ ATAPI devices.

3.6.2.2.1 AHCI Configuration

While entering setup, BIOS auto detects the presence of IDE devices. This displays the status of auto detection of IDE devices.

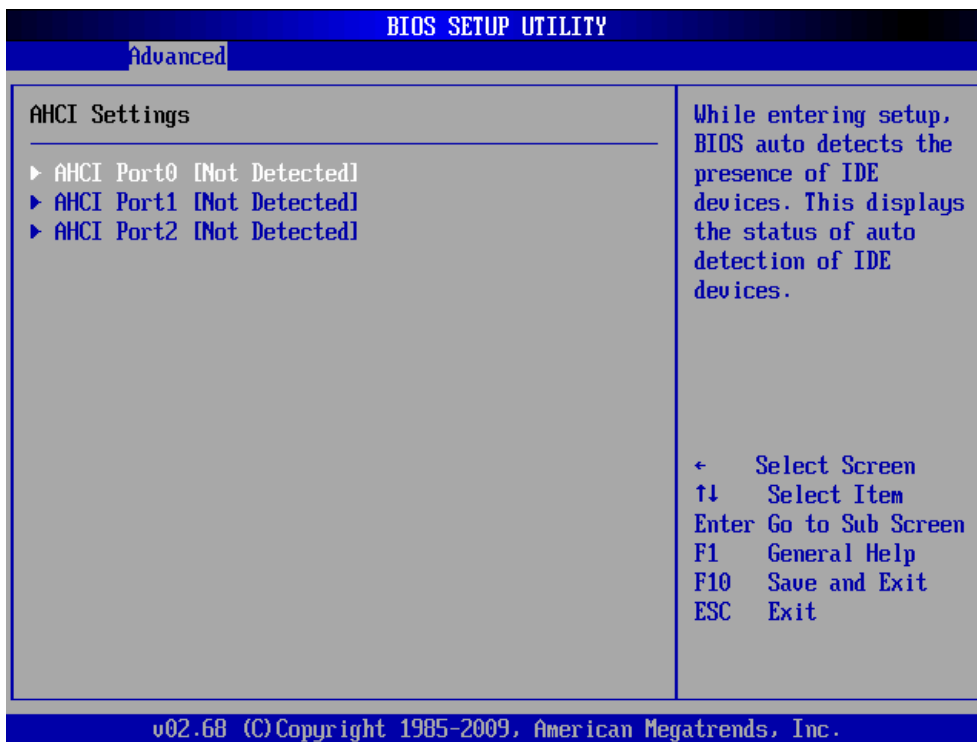

Item	Options	Description
SATA Port 0/ 1/ 2	Auto, Not Installed	Serial port 0/ 1/ 2 mode select.
S.M.A.R.T.	Disabled, Enabled	Select the smart monitoring, analysis, and reporting technology.

3.6.2.3 Super I/O Configuration

You can use this item to set up or change the Super I/O configuration for FDD controllers, parallel ports and serial ports.

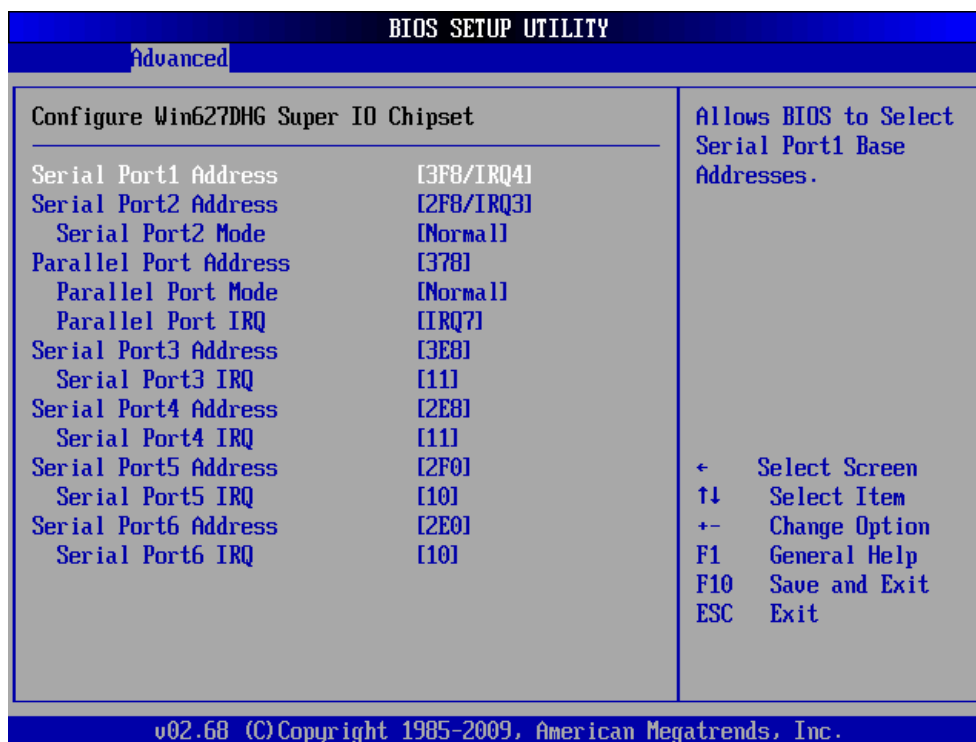

Item	Options	Description
Serial Port 1/ 2/ 3/ 4/ 5/ 6 Address	Disabled, 3F8, 2F8, 3E8, 2E8, 2F0, 2E0	This item allows you select serial port 1 ~ 6 of base addresses.
Serial Port 2/ 5/ 6 Type	422, 485	This item allows you select serial port 2/ 5/ 6 of type.
Serial Port 3/ 4/ 5/ 6 IRQ	4/ 9/ 10/ 11	This item allows you select serial port 3 ~ 6 of IRQ.
Parallel Port Address	Disabled, 378, 278, 3BC	The Parallel Address BIOS option assigns the I/O port address of the parallel port.
Parallel Port Mode	Normal, EPP, ECP, EPP+ECP	The Parallel Port Mode selection selects the mode the parallel port operations in.
Parallel Port IRQ	IRQ5, IRQ7	The Parallel Port Address BIOS option assigns the parallel port interrupt address.

3.6.2.4 Hardware Health Configuration

This section allows you to control H/W monitoring.

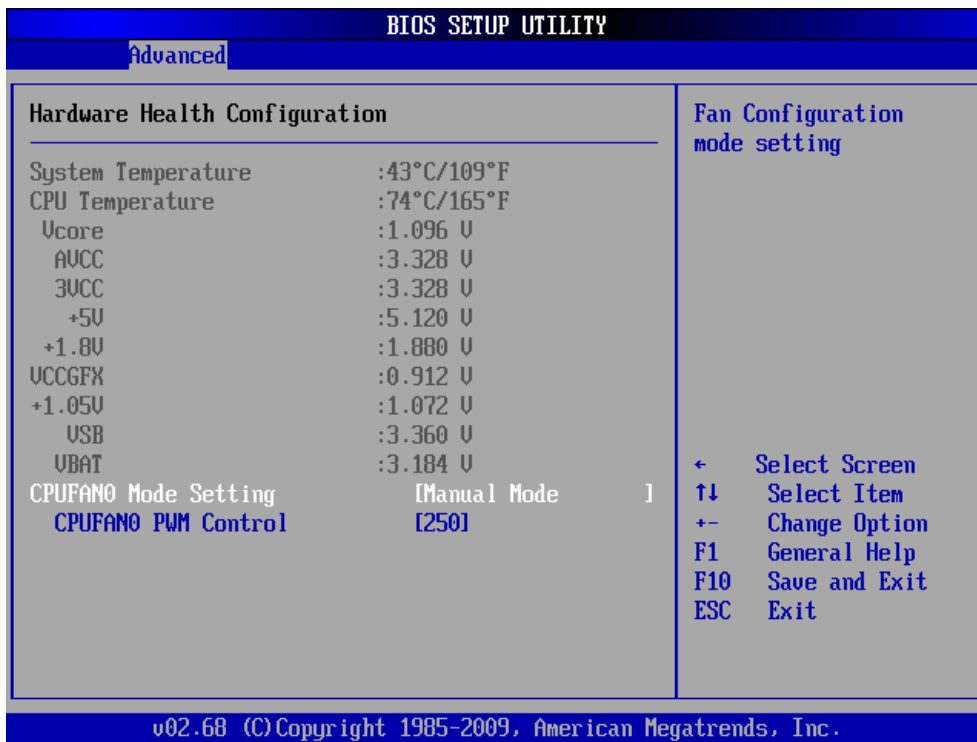

3.6.2.5 ACPI Settings

You can use this item to set up ACPI Configuration. Please refer to 3.5.2.5.1 ~ 3.5.2.5.3 for more details.

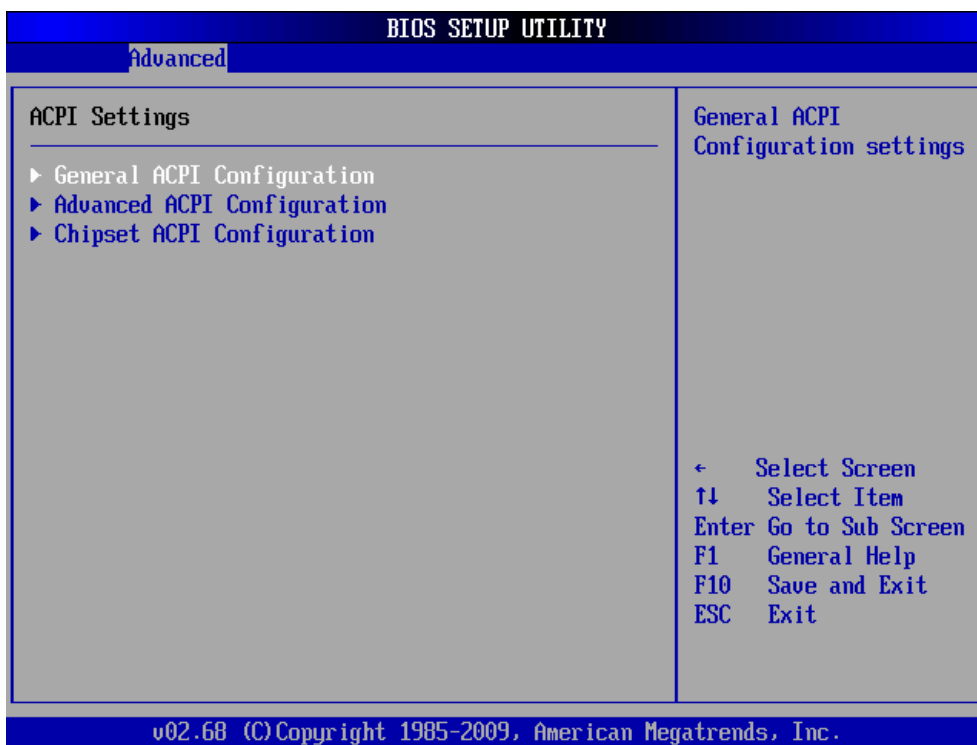

3.6.2.5.1 General ACPI Configuration

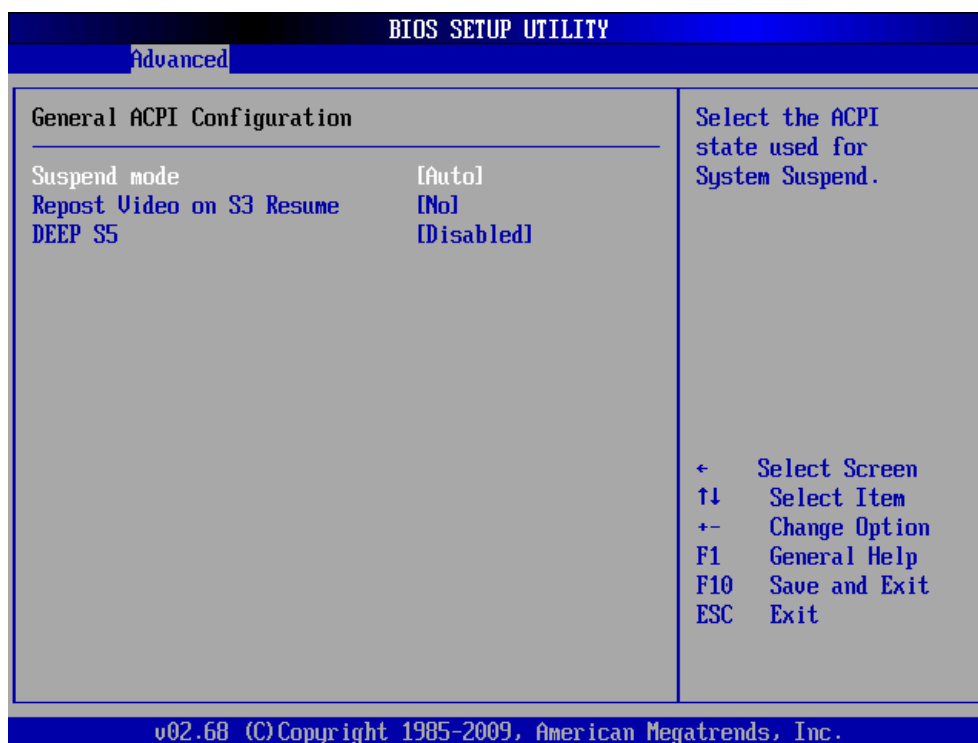

Item	Options	Description
Suspend Mode	S1 (POS), S3 (STR), Auto	Select the ACPI states used for system suspend.
Repost Video on S3 Resume	No, Yes	This item allows you to invoke VGA BIOS POST on S3/ STR resume.
Deep S5	Disabled, Enabled	All PME/ wakeup event will be disabled in S4/ S5 mode when enabled DEEP S5.



Note:

Deep S5=ErP

- ErP mode:**
1. No Timer-Power-On
 2. No Wake On Ring/ LAN

3.6.2.5.2 Advanced ACPI Configuration

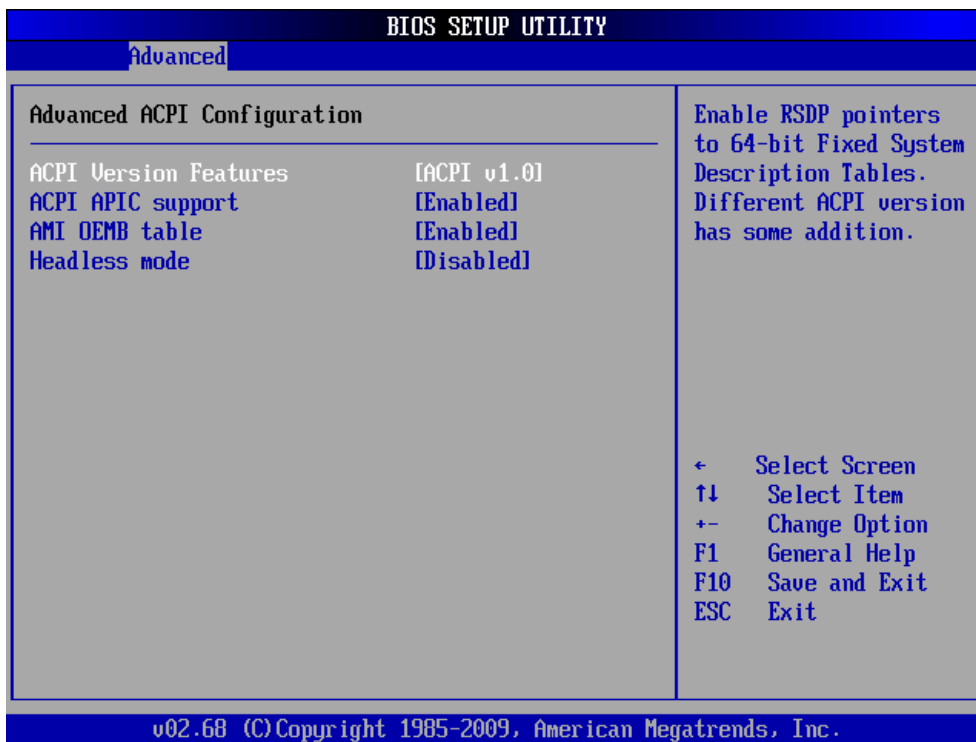

Item	Options	Description
ACPI Version Features	ACPI v1.0, ACPI v2.0, ACPI v3.0	This item allows you enable RSDP pointers to 64-bit fixed system description tables.
ACPI APIC support	Enabled, Disabled	Include APIC table pointer to RSDT pointer list.
AMI OEMB table	Enabled, Disabled	Include OEMB table pointer to R(x)SDT pointer list.
Headless mode	Disabled, Enabled	Enable/ Disable Headless operation mode through ACPI.

3.6.2.5.3 Chipset ACPI Configuration

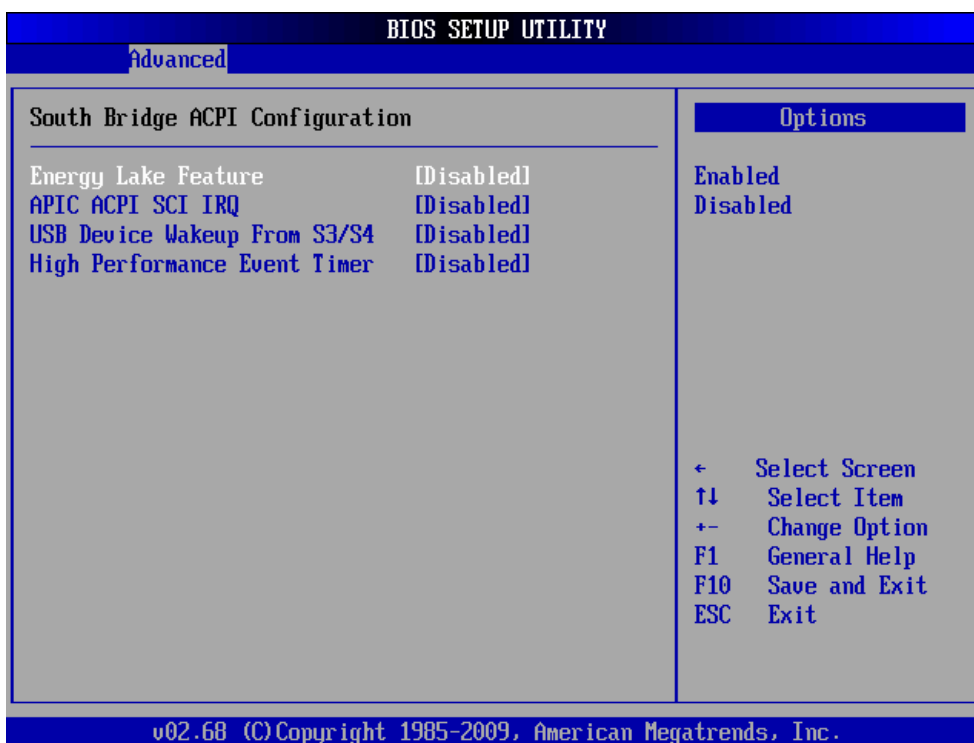

Item	Options	Description
Energy Lake Feature	Disabled, Enabled	This item allows selecting energy lake feature mode.
APIC ACPI SCI IRQ	Disabled, Enabled	This item allows to enable/ disable APIC ACPI SCI IRQ.
USB Device Wakeup From S3/ S4	Disabled, Enabled	This item allows selecting USB device wakeup mode.
High Performance Event Timer	Disabled, Enabled	This section helps to set high performance event timer.

3.6.2.6 USB Configuration

The USB configuration menu is used to read USB configuration information and configure the USB setting.

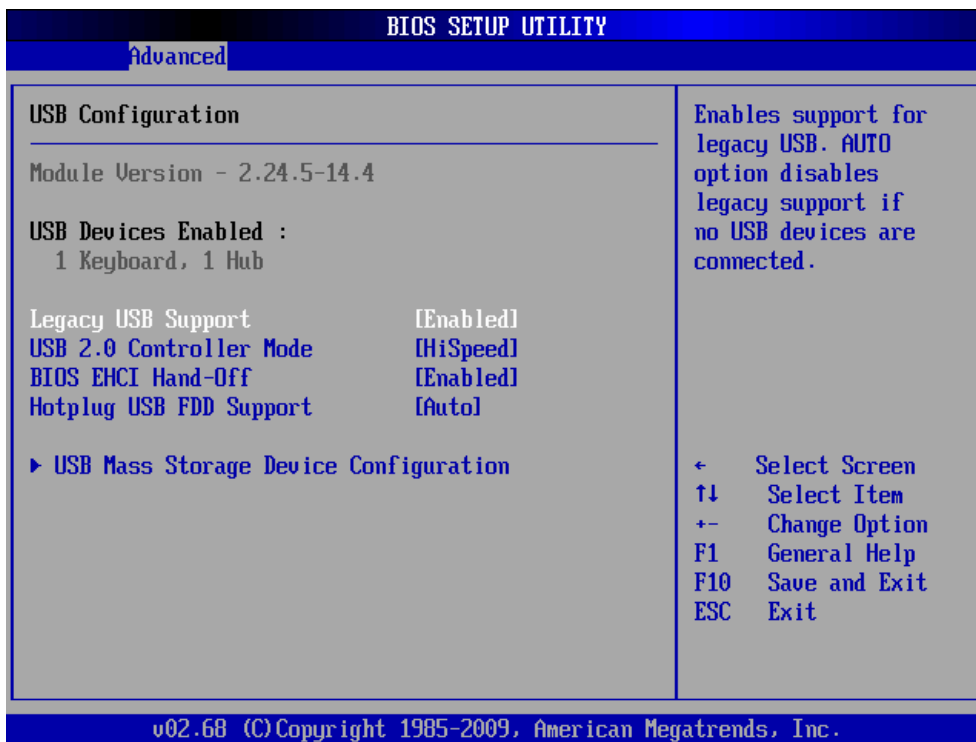

Item	Options	Description
Legacy USB Support	Enabled, Disabled, Auto	Use the Legacy USB Support BIOS option to enable USB mouse and USB keyboard support. Normally if this option is not enabled, any attached USB mouse or USB keyboard does not become available until a USB compatible operating system is fully booted with all USB drivers loaded. When this option is enabled, any attached USB mouse or USB keyboard can control the system even when there is no USB driver loaded onto the system.
USB 2.0 Controller Mode	HiSpeed (480Mbps), FullSpeed (12Mbps)	This item allows you to select HiSpeed (480Mbps) or FullSpeed (12Mbps).
BIOS EHCI Hand-Off	Enabled, Disabled	This is a workaround for OSs without EHCI hand-off support. The EHCI ownership change should be claimed by EHCI driver.
Hotplug USB FDD Support	Enabled, Disabled, Auto	A dummy FDD devices is created that will be associated with the hotplugged FDD later. Auto option creates this dummy device only if there is no USB present.

3.6.2.7 APM Configuration

The APM Configuration menu allows the advanced power management options to be configured.

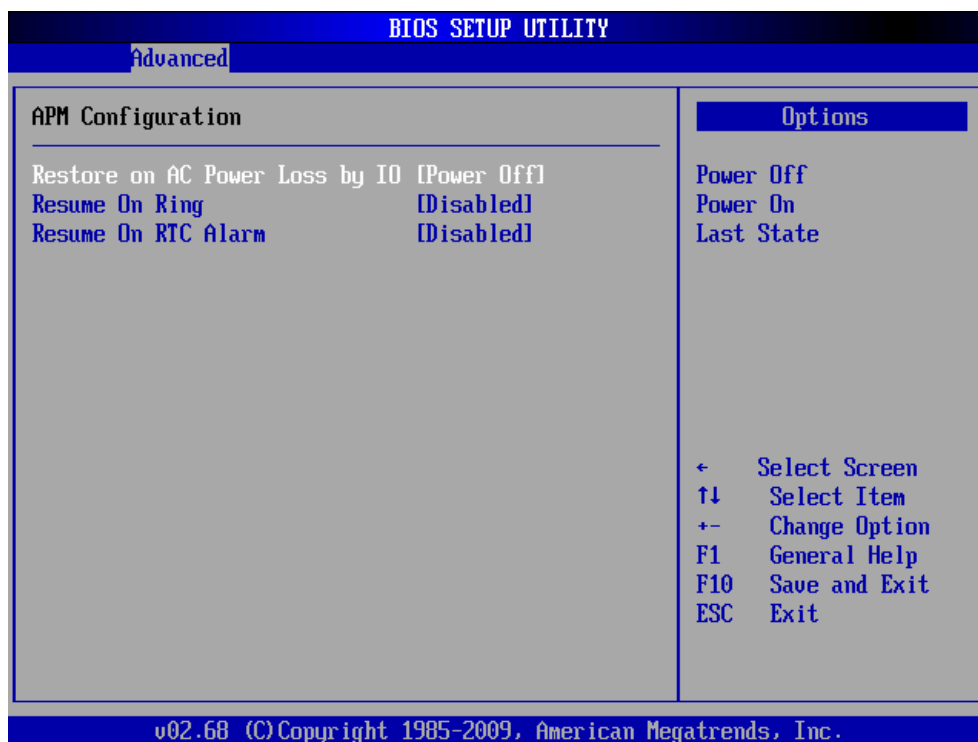

Item	Options	Description
Restore on AC Power Loss by IO	Power On, Power Off, Last State	Use this to set up the system response after a power failure.
Resume On Ring	Disabled, Enabled	Use the Resume on Ring BIOS option to enable activity on the RI (ring in) modem line to rouse the system from a suspend or standby state. That is, the system is roused by an incoming call on modem.
Resume On RTC Alarm	Disabled, Enabled	Use the Resume on RTC Alarm option to specify the time the system should be roused from a suspend state.

3.6.3 Advanced PCI/ PnP Settings

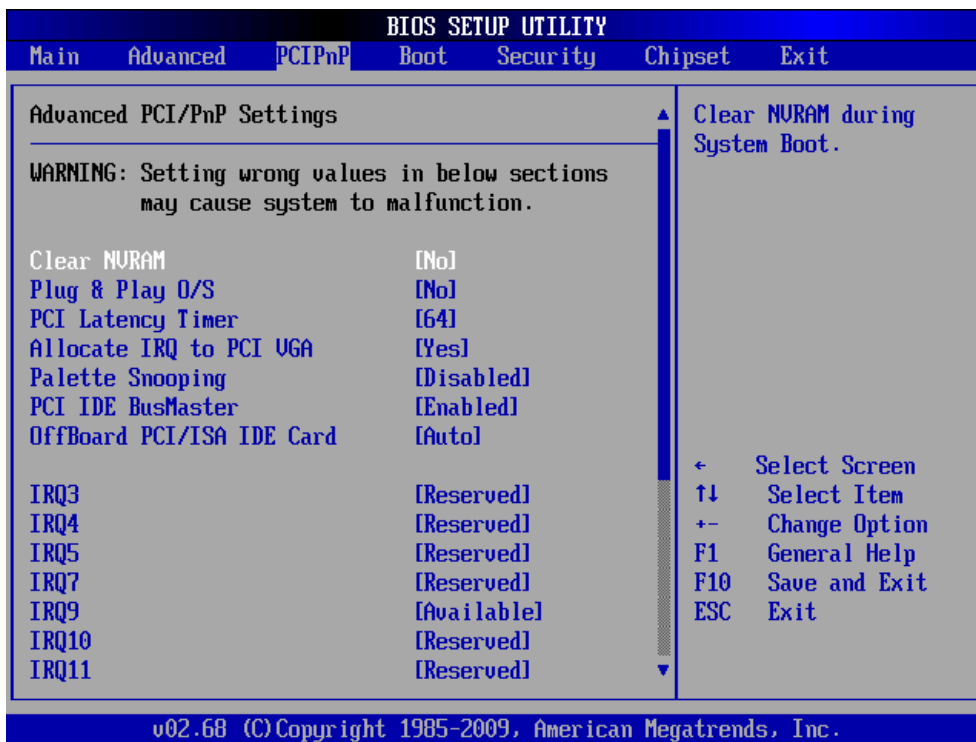

Item	Options	Description
Clear NURAM	No, Yes	Set this value to force the BIOS to clear the Non-volatile Random Access Memory (NVRAM). The Original and Fail-Safe default setting is No.
Plug & Play O/S	No, Yes	When set No, BIOS configures all the device in the system. When set to Yes and if you still a Plug and Play operating system, the operating system configures the plug and Play device not required for boot.
PCI Latency Timer	32, 64, 96, 128, 160, 192, 224, 248	Value in units of PCI clocks for PCI device latency timer register.
Allocate IRQ to PCI VGA	No, Yes	When set to Yes will assigns IRQ to PCI VGA card if card requests IRQ. When set to No will not assign IRQ to PCI VGA card even if card requests an IRQ.
PaletteSnooping	Disabled, Enabled	This item designed to solve problems caused by some non-standard VGA card.

PCI IDE BusMaster	Disabled, Enabled	When set to enabled BIOS uses PCI busmastering for reading/ writing to IDE drives.
OffBoard PCI/ ISA IDE Card	Auto, PCI Slot 1/ 2/ 3/ 4/ 5/ 6	Some PCI IDE cards may require this to be set to the PCI slot number that is holding the card. When set to auto will works for most PCI IDE cards.
IRQ3/ 4/ 5/ 7/ 9/ 10/ 11	Available, Reserved	Use the IRQ# address to specify what IRQs can be assigned to a particular peripheral device.

3.6.4 Boot Settings

Use the Boot menu to configure system boot options.



3.6.4.1 Boot Settings Configuration



Item	Options	Description
Quick Boot	Disabled, Enabled	Use the quick boot BIOS option to make the computer speed up the boot process.
Quiet Boot	Disabled, Enabled	Use the quiet boot BIOS option to select the screen display when the system boots.
AddOn ROM Display Mode	Force BIOS, Keep Curren	The AddOn ROM Display Mode option allows add-on ROM (read-only memory) messages to be displayed.
Bootup Num-Lock	On, Off	The Bootup Num-Lock BIOS option allows the number Lock setting to be modified during boot up.
PS/2 Mouse Support	Disabled, Enabled, Auto	This select support for PS/w mouse.
Wait For 'F1' if Error	Disabled, Enabled	When set to enable, the system waits for the F1 key to be pressed when error occurs. This allows option ROM to trap interrupt19.
Hit 'DEL' Message Display	Disabled, Enabled	This displays 'Press to run Setup> in POST.
Interrupt 19 Capture	Disabled, Enabled	This allows option ROMs to trap interrupt19.

3.6.4.2 Boot Device Priority

Use the Boot Device Priority menu to specify the boot sequence from the available devices.

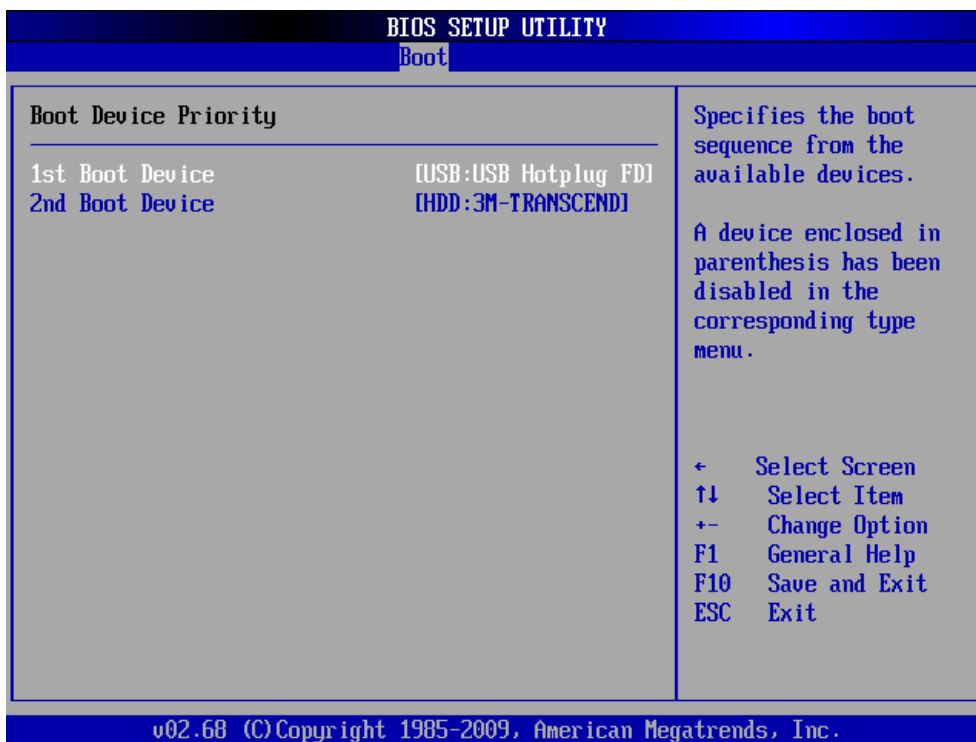

3.6.4.3 Hard Disk Devices

Use the Hard Disk Drives menu to specify the boot sequence of the available HDDs.

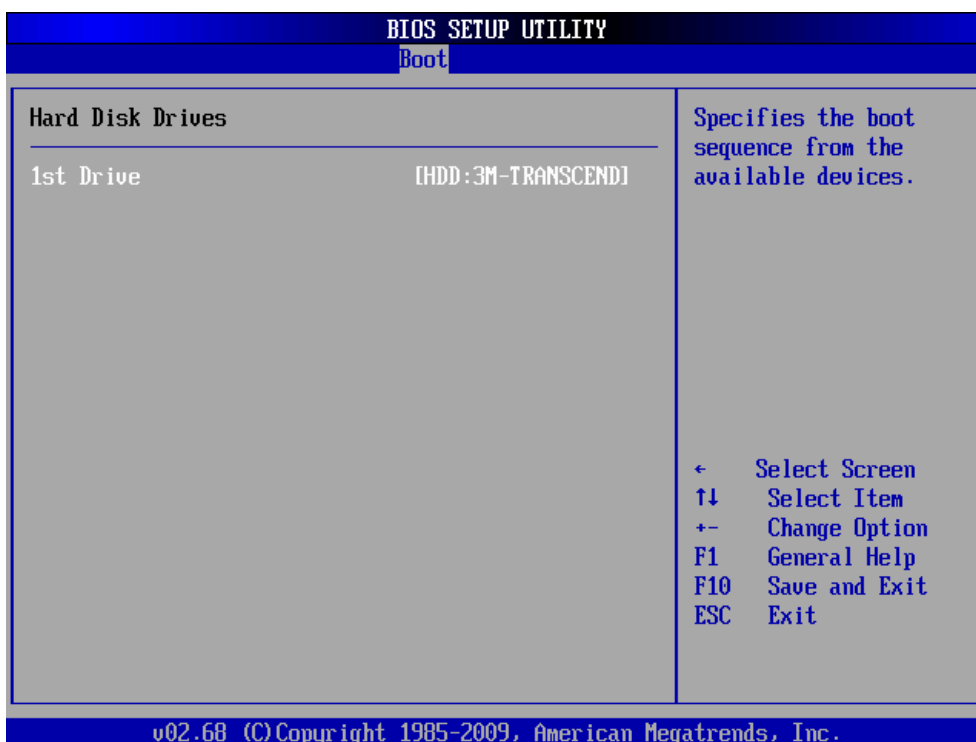

3.6.4.4 Removable Devices

Use the Removable Drives menu to specify the boot sequence of the available FDDs.

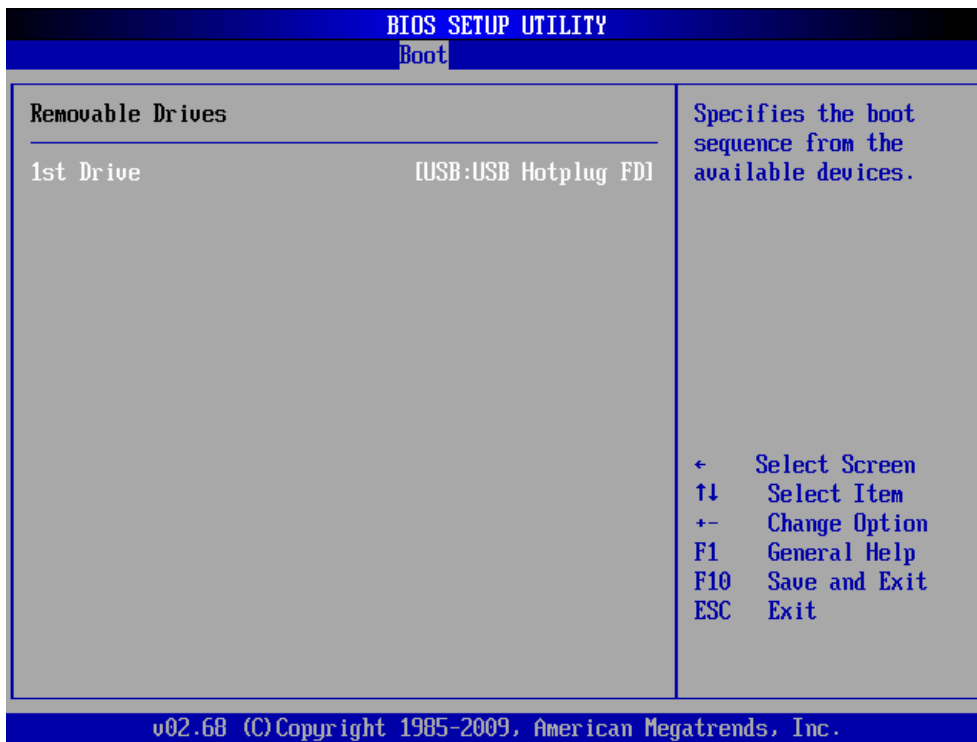

3.6.5 Security Settings

Use the Security menu to set system and user password.

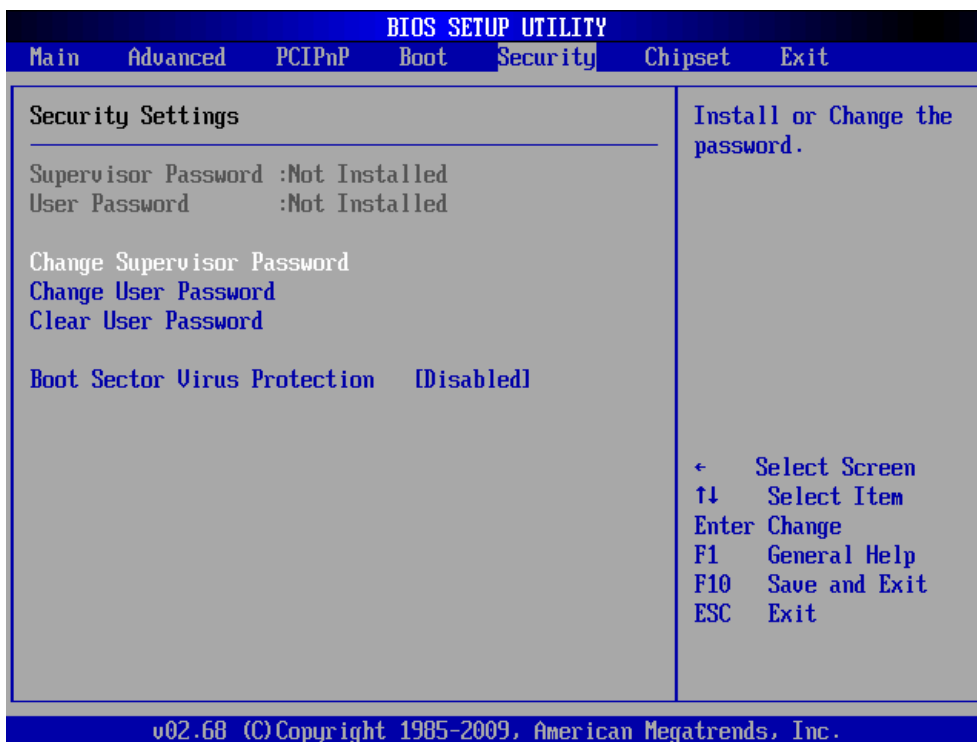

3.6.5.1 Change Supervisor/ User Password

To either install or change the password.

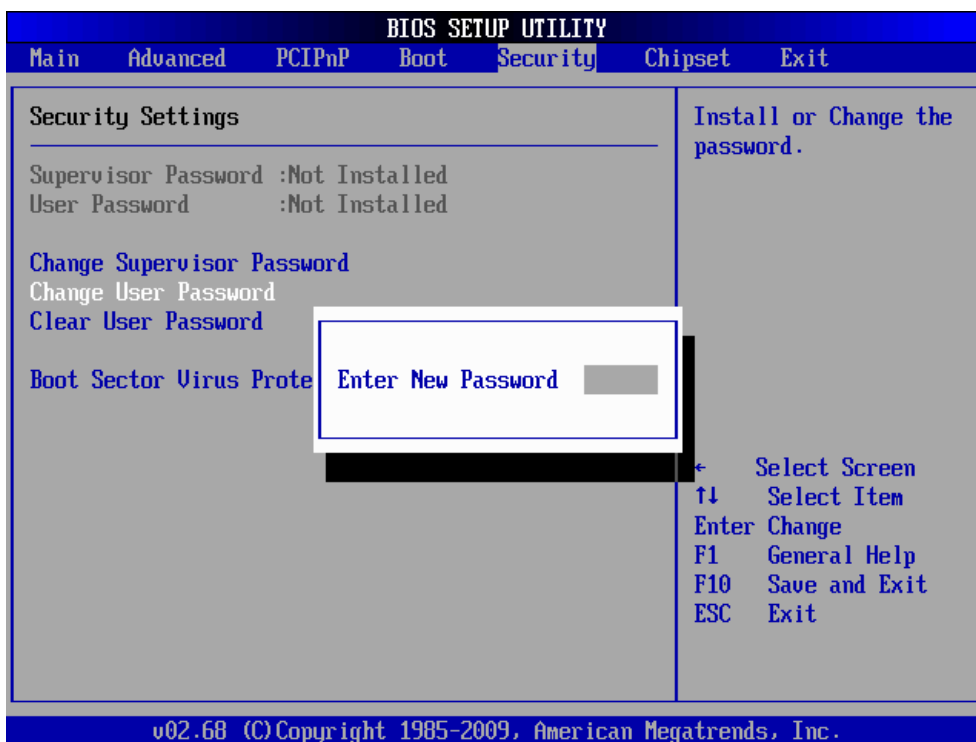
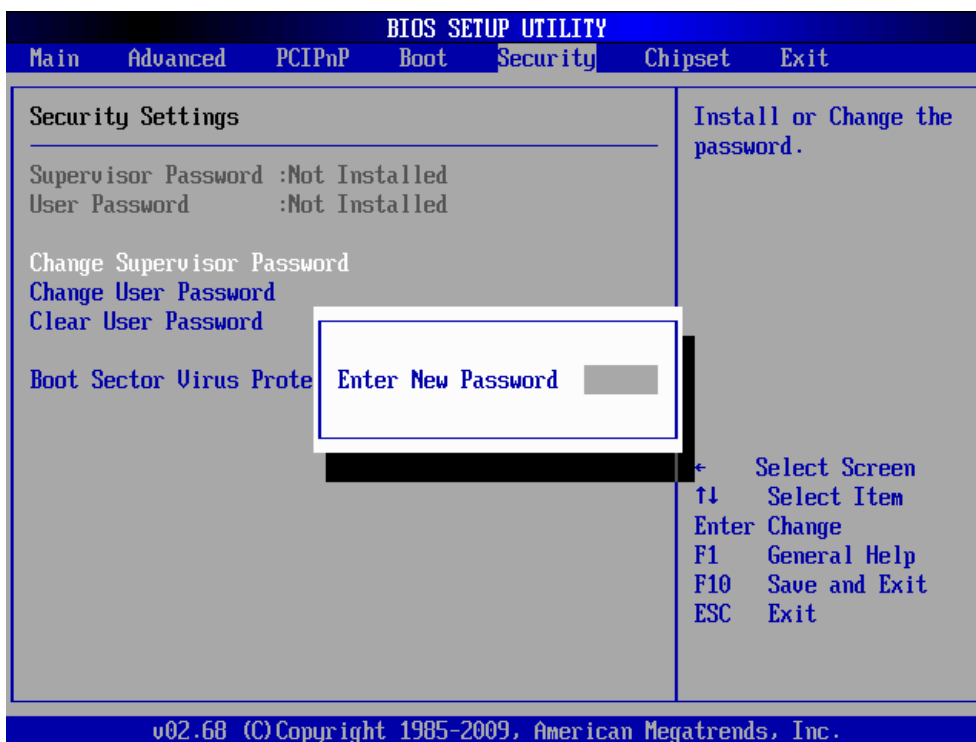

3.6.5.2 Clear User Password

Use the Clear User Password to clean a user password.

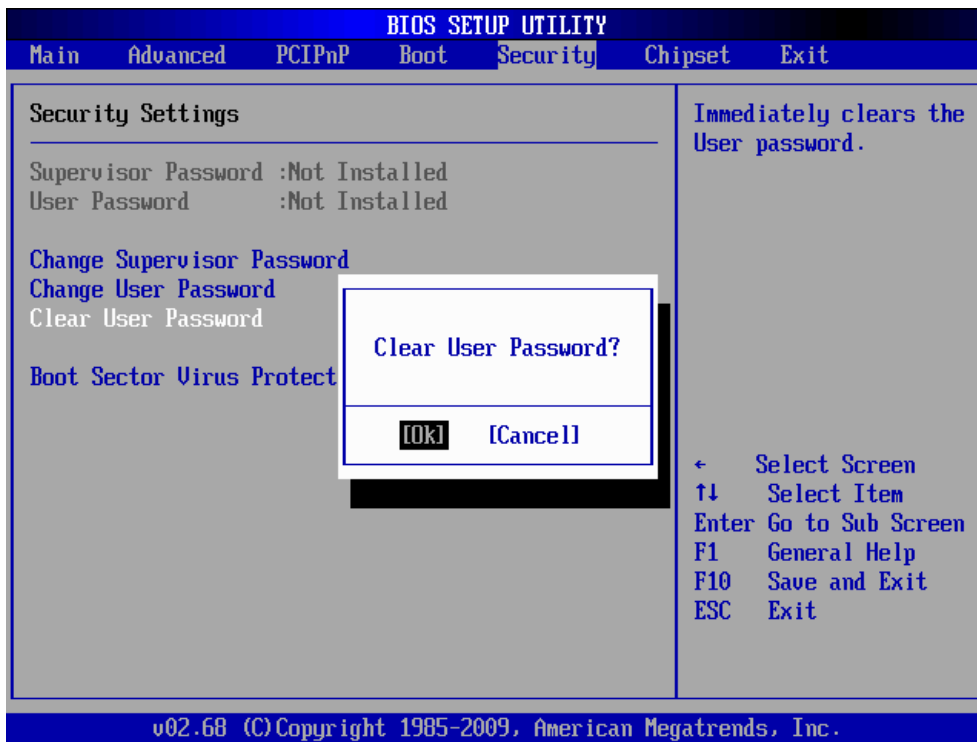

3.6.5.3 Boot Sector Virus Protection

The boot sector virus protection will warn if any program tries to write to the boot sector.

3.6.6 Advanced Chipset Settings

Use the chipset menu to access the Northbridge and Southbridge configuration menus.



3.6.6.1 North Bridge Configuration

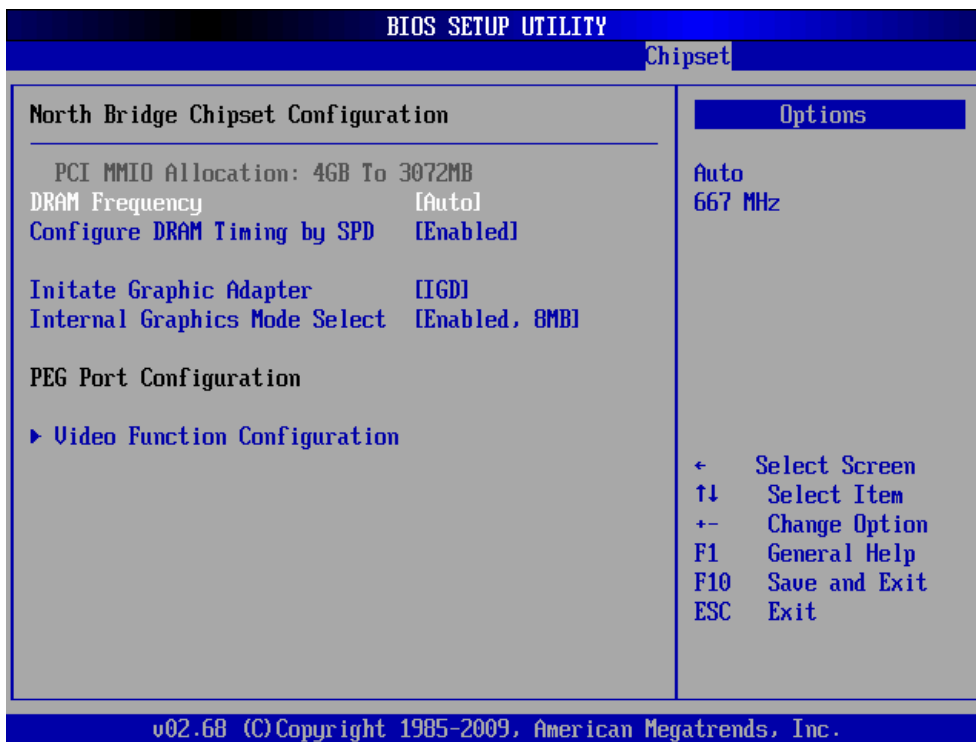

Item	Option	Description
DRAM Frequency	Auto, 667MHz	This item allows you to manually change DRAM frequency.
Configure DRAM Timing by SPD	Disabled, Enabled	This item allows you to enable or disable by DRAM SPD.
Initiate Graphic Adapter	IGD, PEG/IGD	This item allows you to select which graphics controller to use as the primary boot device.
Internal Graphics Mode Select	Disabled, Enabled 32MB, Enabled 64MB, Enabled 128MB	This option determines the amount of system memory that can be used by the internal graphics device.
PEG Port Configuration	Disabled, Enabled	Use the PEG Port option to enable or disable the PCI Express port.

3.6.6.1.1 Video Function Configuration

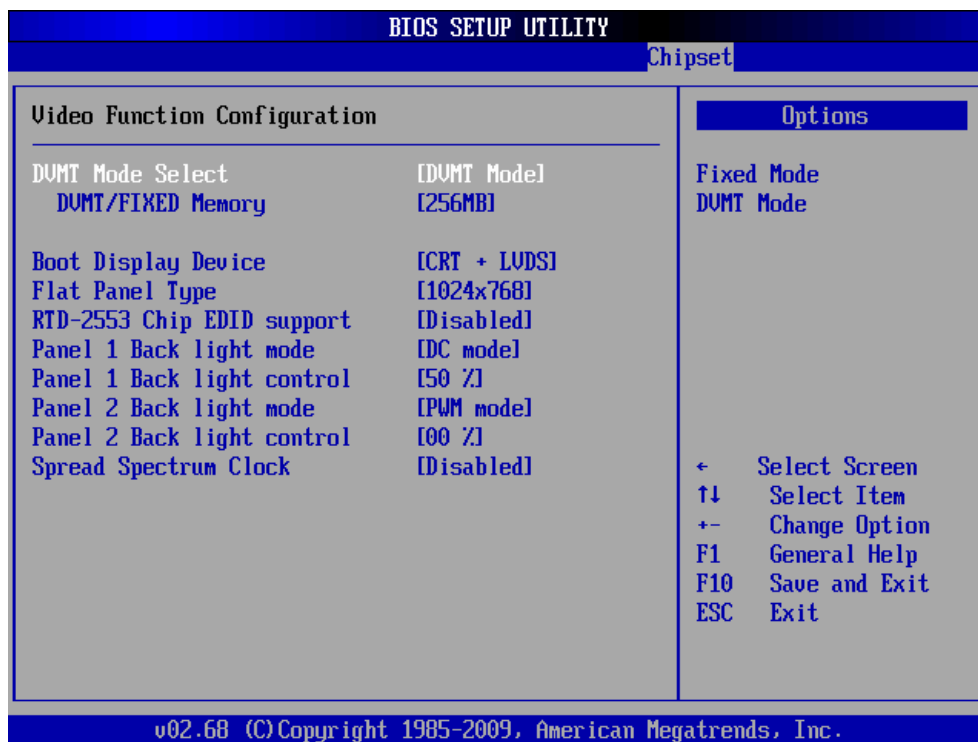

Item	Option	Description
DVMT Mode Select	Fixed Mode, DVMT Mode, Combo Mode	Displays the active system memory mode.
DVMT/ FIXED Memory	64MB, 128MB, Maximum DVMT	Specifies the amount of DVMT/ FIXED system memory to allocate for video memory.
Boot Display Device	VBIOS-Default, CRT, LVDS, CRT+LVDS	Select boot display device at post stage.

EBM-PNV User's Manual

<p>Flat Panel Type</p>	<p>640 x 480, 800 x 600, 1024 x 768, 1024 x 600, 1024 x 576, 800 x 480, 1280 x 720, 1280 x 768, 800 x 600, 1024 x 600, 1024 x 768, 1024 x 768, 1024 x 768, 1280 x 800, 1280 x 600, 1366 x 768</p>	<p>This item allows you to select which panel resolution you want.</p>
<p>RTD-2553 Chip EDID support</p>	<p>Disabled, Enabled</p>	<p>This item allows you to enable or disable RTD-2553 Chip EDID support.</p>
<p>Panel 1/ 2 Back light mode/ Control</p>	<p>PWM mode, DC mode</p>	<p>This item allows you to select Panel 1/ 2 backlight mode/ control.</p>
<p>Spread Spectrum Clock</p>	<p>Disabled, Enabled</p>	<p>This item allows you to enable or disable spread spectrum clock.</p>

3.6.6.2 South Bridge Configuration



Item	Option	Description
USB Functions	Disables, 2/ 4/ 6/ 8/ 10 USB Ports	This option enables the number of USB ports desired or disables the USB function.
USB 2.0 Controller	Disabled, Enabled	This option is disabled by default.
HAD Controller	Disabled, Enabled	This option is used to enable the southbridge high definition audio controller.
SMBUS Controller	Disabled, Enabled	This option is enabled by default.
PCIe Wake	Disabled, Enabled	This section allows selecting PCIe wake mode.
LAN Boot rom	Disabled, Enabled	This section allows selecting LAN boot rom mode.
PCIE Port 0/ 1/ 2	Disabled, Enabled, Auto	This section allows selecting PCIE port 0/ 1/ 2 mode.

3.6.7 Exit Options

Use the Exit menu to load default BIOS values, optional failsafe values and to save configuration changes.

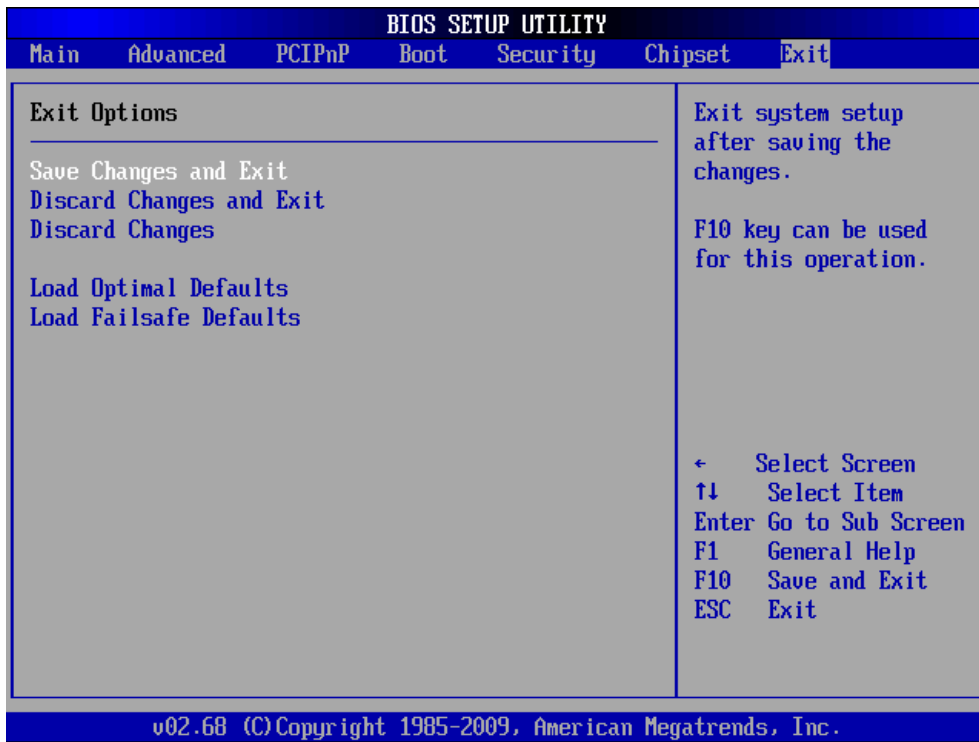

3.6.7.1 Save Changes and Exit

Use the save changes and reset option to save the changes made to the BIOS options and to exit the BIOS configuration setup program.



3.6.7.2 Discard Changes and Exit

Use the Discard changes and Exit option to exit the system without saving the changes made to the BIOS configuration setup program.



3.6.7.3 Discard Changes

Use the Discard Changes option to discard the changes and remain in the BIOS configuration setup program.

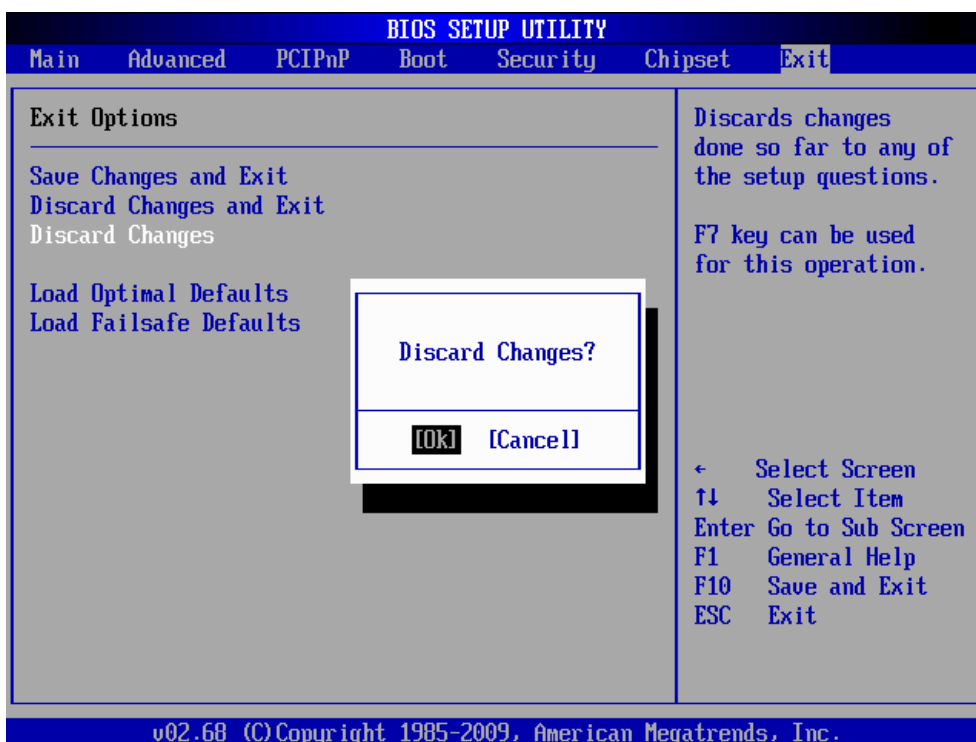

3.6.7.4 Load Optimal Defaults

Use the Load Optimal Defaults option to load the optimal default values for each of the parameters on the setup menus. F9 key can be used for this operation.

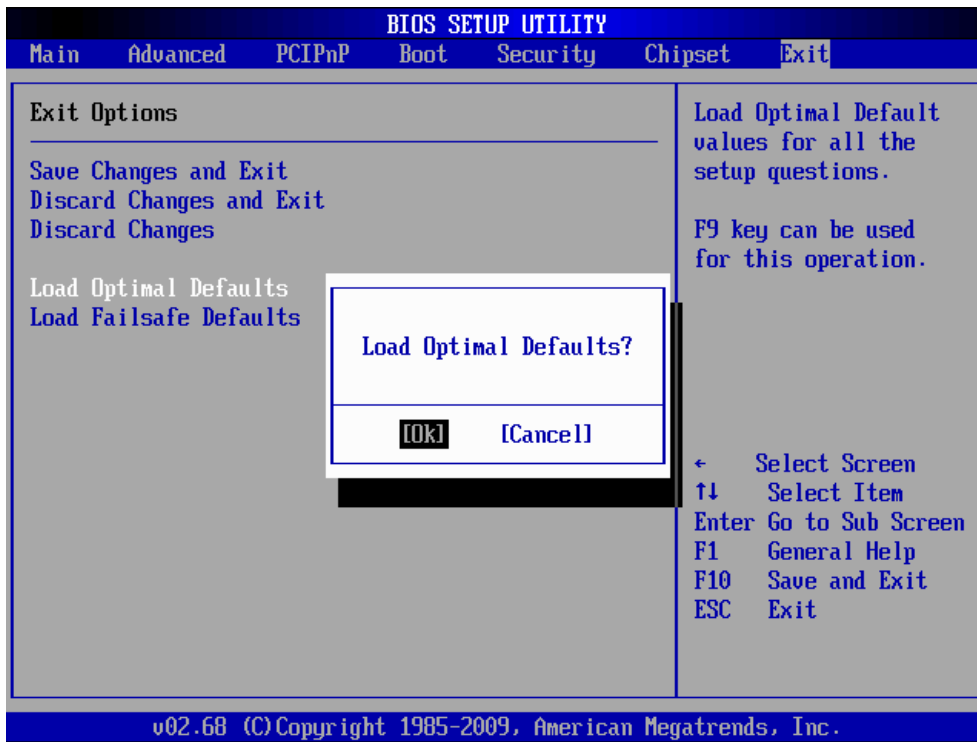

3.6.7.5 Load Failsafe Defaults

Use the Load Failsafe Defaults option to load failsafe default values for each of the parameters on the Setup menus. F8 key can be used for this operation.



4. Drivers Installation



Note: Installation procedures and screen shots in this section are for your reference and may not be exactly the same as shown on your screen.

4.1 Install Chipset Driver (For Intel ICH8-M)

Insert the Supporting DVD-ROM to DVD-ROM drive, and it should show the index page of Avalue's products automatically. If not, locate Index.htm and choose the product from the menu left, or link to \Driver_Chipset\Intel\ICH8-M.



Note: The installation procedures and screen shots in this section are based on Windows XP operation system. If the warning message appears while the installation process, click Continue to go on.

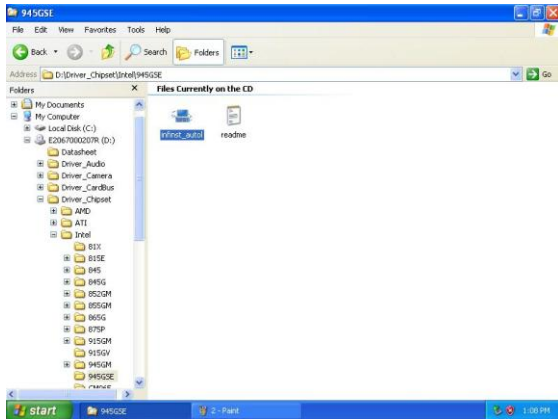

Step 1. Locate 「\Driver_Chipset\Intel\OM57\ \ininst_autol.exe」.



Step 2. Click **Next**.



Step 3. Click **Yes**.



Step 4. Click **Next**.



Step 5. Click **Finish** to complete setup.

4.2 Install Display Driver (For Intel Pineview)

Insert the Supporting DVD-ROM to DVD-ROM drive, and it should show the index page of Avalue's products automatically. If not, locate Index.htm and choose the product from the menu left, or link to **\\Driver_Video\\Intel\\Pineview**.



Note: The installation procedures and screen shots in this section are based on Windows XP operation system.

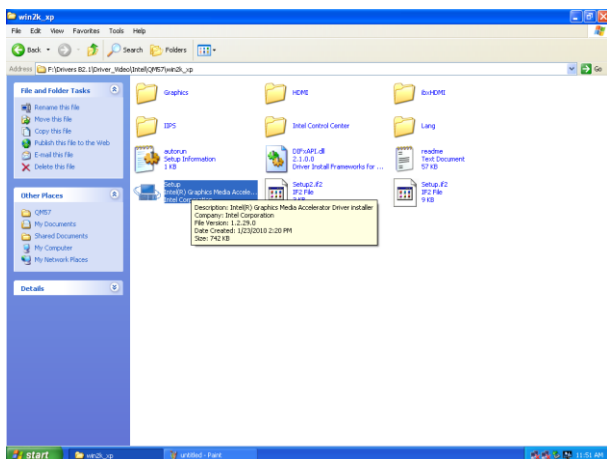

Step 1. Locate 「Driver_Video\\Intel\\Pineview\\Setup.exe」.



Step 2. Click **Next**.

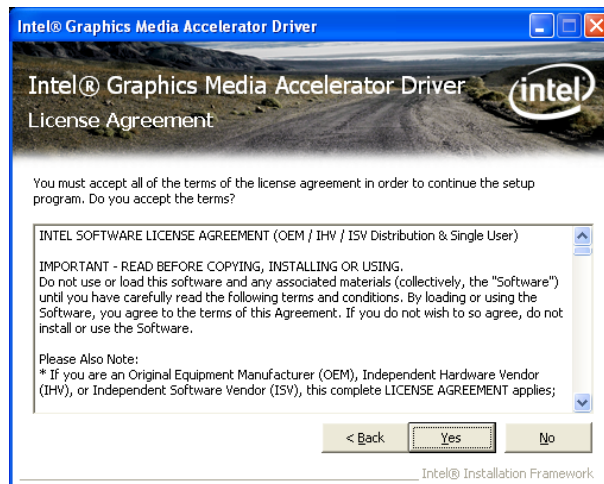

Step 3. Click **Yes**.



Step 4. Click **Next**.

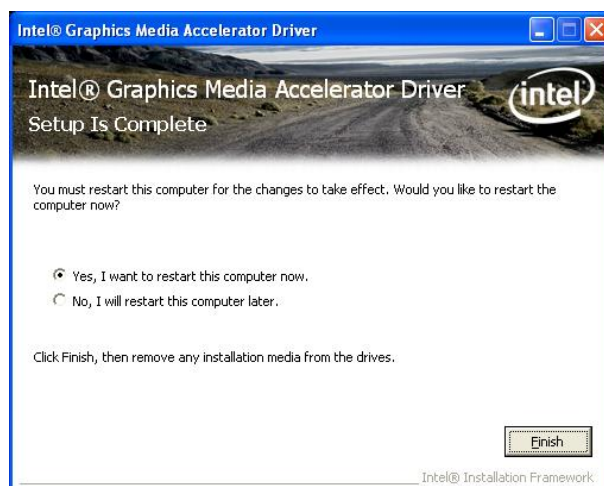

Step 5. Click **Finish** to complete setup.

4.3 Install Audio Driver (For Realtek ALC888)

Insert the Supporting CD-ROM to CD-ROM drive, and it should show the index page of Avalue's products automatically. If not, locate Index.htm and choose the product from the menu left, or link to `\\Driver_Audio\Realtek \ALC888`.



Note: The installation procedures and screen shots in this section are based on Windows 2000 operation system.

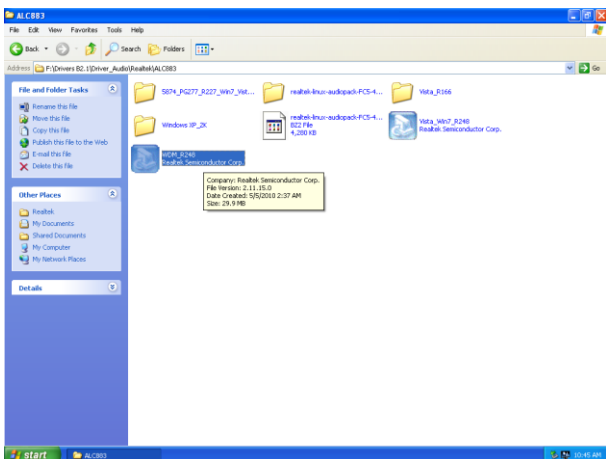

Step 1. Locate 「\\Driver_Audio\Intel\6300ESB ALC888\setu.exe」.

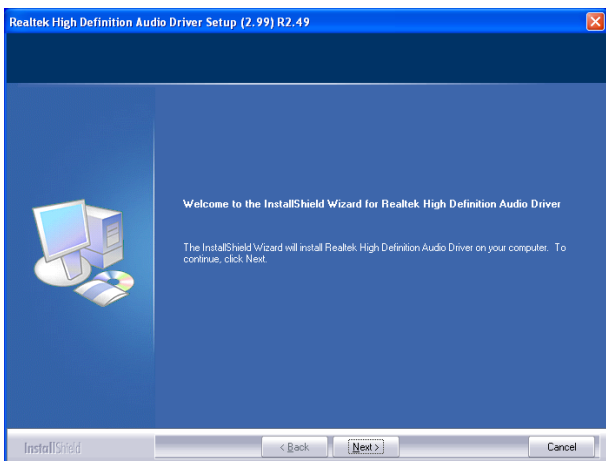

Step 2. Select **Next** to the next step.

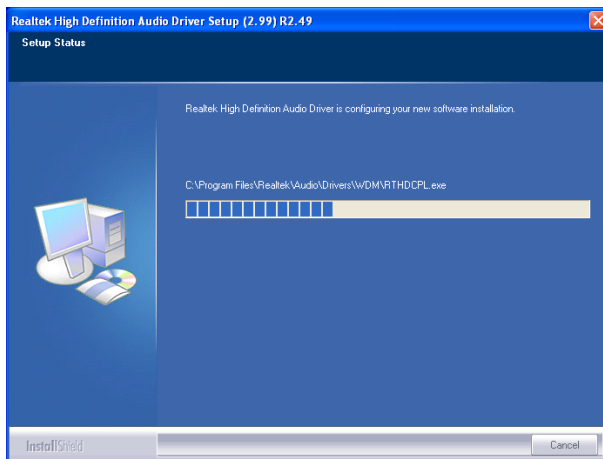

Step 3. The program executes the Setup automatically.

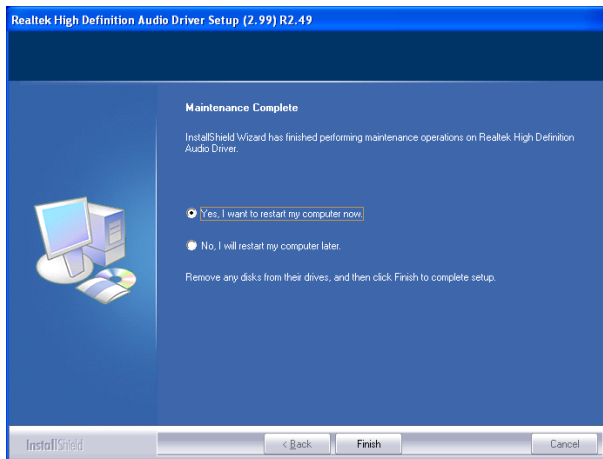

Step 4. Click **Finish** to complete the setup.

4.4 Install Ethernet Driver (For Intel 82574L)

Insert the Supporting DVD-ROM to DVD-ROM drive, and it should show the index page of Avalue's products automatically. If not, locate Index.htm and choose the product from the menu left, or link to **D:\Driver_Gigabit\Intel\ 82574L**.



Note: The installation procedures and screen shots in this section are based on Windows XP operation system.

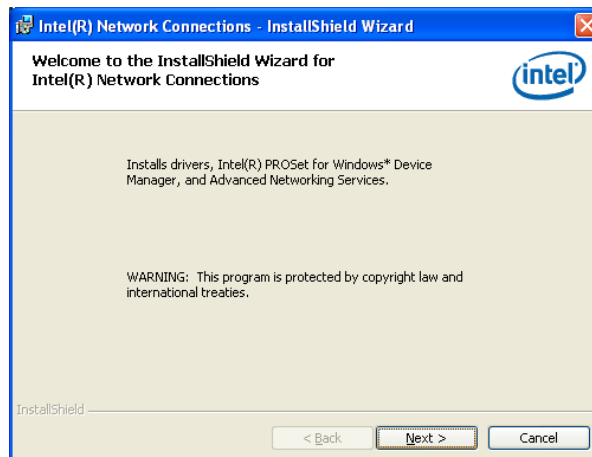

Step 3. Click **Next** to run the installation.

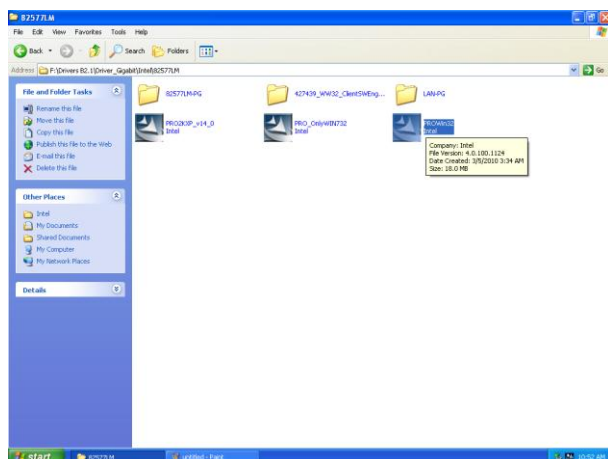

Step 1. Locate 「\Driver_Gigabit\Intel\ 82574L」 and choose your system OS.

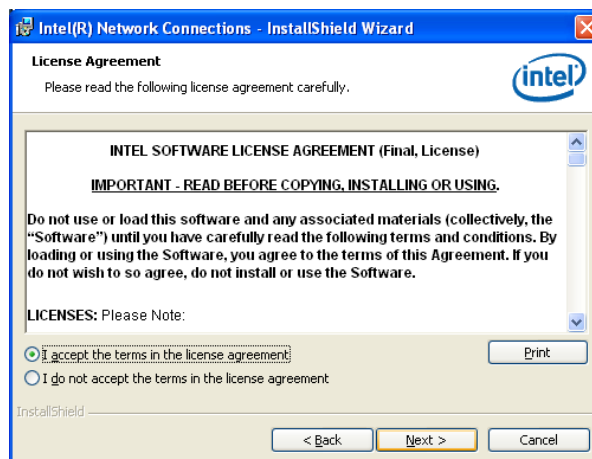

Step 4. Click **Accept** to continue.

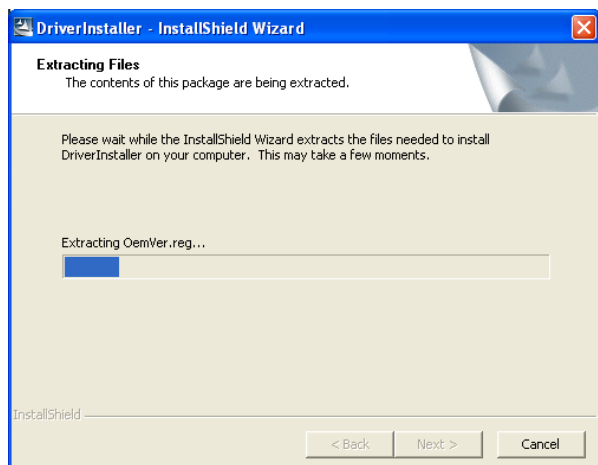

Step 2. Click **Next**.

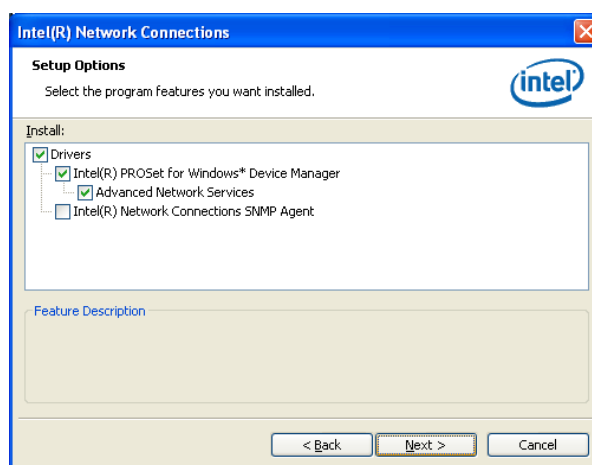

Step 5. Click **Next**.

EBM-PNV User's Manual

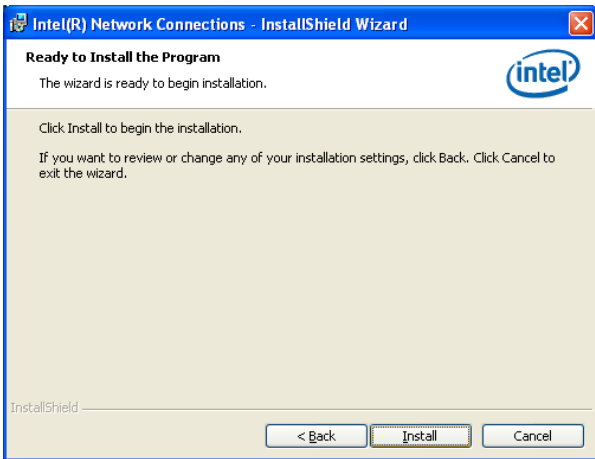

Step 5. Click **Install** to next step.

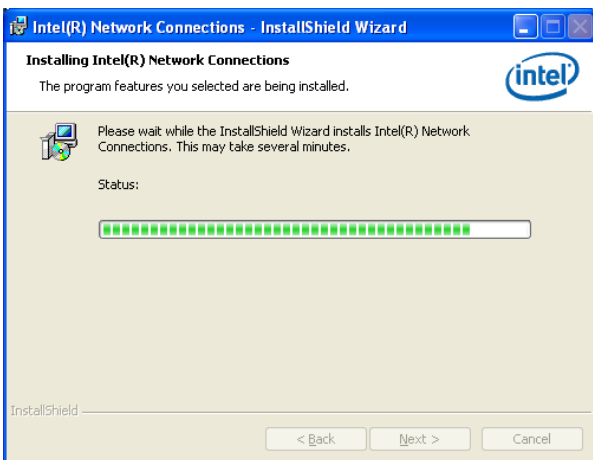

Step 6. Click **Next** to next step.

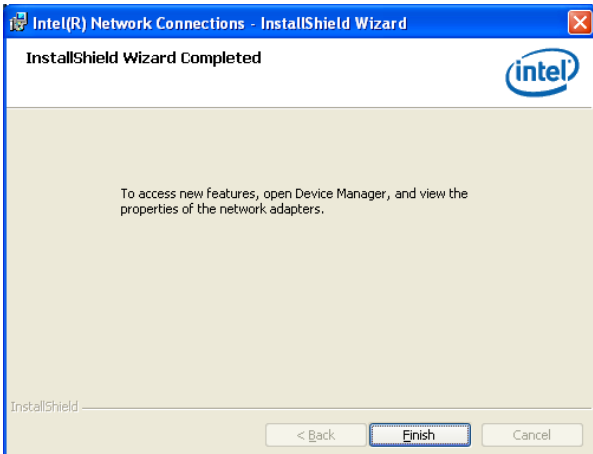

Step 7. Click **Finish** to complete the setup.

5. Mechanical Drawing



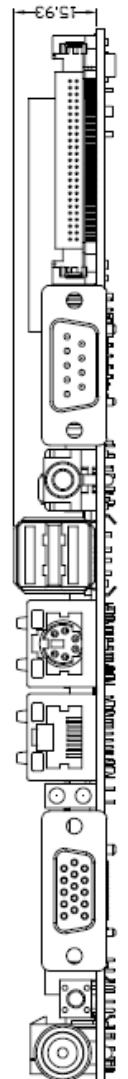
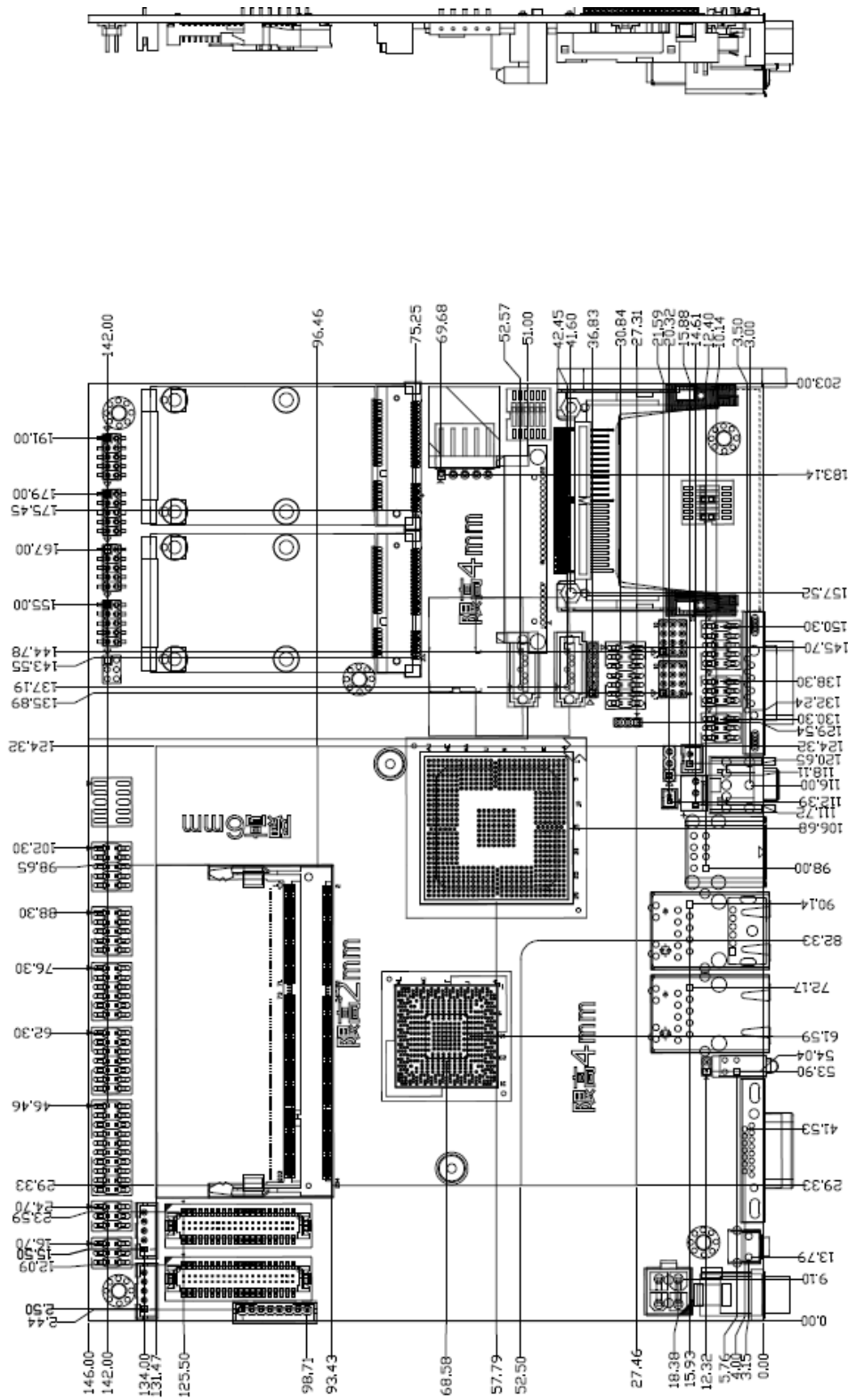

Unit: mm

