

EBM-945GSE

5.25" Intel 945GSE Atom™ N270 Mini Module

User's Manual



3rd Ed – 06 Aug 2010

FCC Statement



THIS DEVICE COMPLIES WITH PART 15 FCC RULES. OPERATION IS SUBJECT TO THE FOLLOWING TWO CONDITIONS:

- (1) THIS DEVICE MAY NOT CAUSE HARMFUL INTERFERENCE.
- (2) THIS DEVICE MUST ACCEPT ANY INTERFERENCE RECEIVED INCLUDING INTERFERENCE THAT MAY CAUSE UNDESIRE OPERATION.

THIS EQUIPMENT HAS BEEN TESTED AND FOUND TO COMPLY WITH THE LIMITS FOR A CLASS "A" DIGITAL DEVICE, PURSUANT TO PART 15 OF THE FCC RULES.

THESE LIMITS ARE DESIGNED TO PROVIDE REASONABLE PROTECTION AGAINST HARMFUL INTERFERENCE WHEN THE EQUIPMENT IS OPERATED IN A COMMERCIAL ENVIRONMENT. THIS EQUIPMENT GENERATES, USES, AND CAN RADIATE RADIO FREQUENCY ENERGY AND, IF NOT INSTALLED AND USED IN ACCORDANCE WITH THE INSTRUCTION MANUAL, MAY CAUSE HARMFUL INTERFERENCE TO RADIO COMMUNICATIONS.

OPERATION OF THIS EQUIPMENT IN A RESIDENTIAL AREA IS LIKELY TO CAUSE HARMFUL INTERFERENCE IN WHICH CASE THE USER WILL BE REQUIRED TO CORRECT THE INTERFERENCE AT HIS OWN EXPENSE.

Copyright Notice

Copyright © 2009 Avalue Technology Inc., ALL RIGHTS RESERVED.

No part of this document may be reproduced, copied, translated, or transmitted in any form or by any means, electronic or mechanical, for any purpose, without the prior written permission of the original manufacturer.

Trademark Acknowledgement

Brand and product names are trademarks or registered trademarks of their respective owners.

Disclaimer

Avalue Technology Inc. reserves the right to make changes, without notice, to any product, including circuits and/or software described or contained in this manual in order to improve design and/or performance. Avalue Technology assumes no responsibility or liability for the use of the described product(s), conveys no license or title under any patent, copyright, or masks work rights to these products, and makes no representations or warranties that these products are free from patent, copyright, or mask work right infringement, unless otherwise specified. Applications that are described in this manual are for illustration purposes only. Avalue Technology Inc. makes no representation or warranty that such application will be suitable for the specified use without further testing or modification.

Life Support Policy

Avalue Technology's PRODUCTS ARE NOT FOR USE AS CRITICAL COMPONENTS IN LIFE SUPPORT DEVICES OR SYSTEMS WITHOUT THE PRIOR WRITTEN APPROVAL OF Avalue Technology Inc.

As used herein:

1. Life support devices or systems are devices or systems which, (a) are intended for surgical implant into body, or (b) support or sustain life and whose failure to perform, when properly used in accordance with instructions for use provided in the labeling, can be reasonably expected to result in significant injury to the user.
2. A critical component is any component of a life support device or system whose failure to perform can be reasonably expected to cause the failure of the life support device or system, or to affect its safety or effectiveness.

A Message to the Customer

Avalue Customer Services

Each and every Avalue's product is built to the most exacting specifications to ensure reliable performance in the harsh and demanding conditions typical of industrial environments. Whether your new Avalue device is destined for the laboratory or the factory floor, you can be assured that your product will provide the reliability and ease of operation for which the name Avalue has come to be known.

Your satisfaction is our primary concern. Here is a guide to Avalue's customer services. To ensure you get the full benefit of our services, please follow the instructions below carefully.

Technical Support

We want you to get the maximum performance from your products. So if you run into technical difficulties, we are here to help. For the most frequently asked questions, you can

EBM-945GSE

easily find answers in your product documentation. These answers are normally a lot more detailed than the ones we can give over the phone. So please consult the user's manual first.

To receive the latest version of the user's manual; please visit our Web site at:

<http://www.avalue.com.tw/>

If you still cannot find the answer, gather all the information or questions that apply to your problem, and with the product close at hand, call your dealer. Our dealers are well trained and ready to give you the support you need to get the most from your Avalue's products. In fact, most problems reported are minor and are able to be easily solved over the phone. In addition, free technical support is available from Avalue's engineers every business day. We are always ready to give advice on application requirements or specific information on the installation and operation of any of our products. Please do not hesitate to call or e-mail us.

Headquarters and Branch

Avalue Technology Inc.

7F, 228, Lian-cheng Road, Chung Ho City, Taipei, Taiwan

Tel: +886-2-8226-2345

Fax: +886-2-8226-2777

Information: sales@avalue.com.tw

Service: service@avalue.com.tw

Avalue USA

Avalue Technology Inc.

200 Tornillo Way, Suite 210, Tinton Falls,
NJ 07712

Tel: +1-732-578-0200

Fax: +1-732-578-0250

Information: sales@avalue-usa.com

Service: support@avalue-usa.com

Avalue Europe

Avalue Europe A/S

Moelledalen 22C, 3140
Aalsgaarde, Denmark

Tel: +45-7025-0310

Fax: +45-4975-5026

Information: sales.europe@avalue.com.tw

Service: service.europe@avalue.com.tw

BCM Advanced Research

BCM Advanced Research an Avalue Company

7 Marconi, Irvine, CA92618

Tel: +1-949-470-1888

Fax: +1-949-470-0971

Information: BCMSales@bcmcom.com

Web: www.bcmcom.com

Avalue China

Avalue Technology Inc.

Room 805, Building 9, No.99 Tianzhou Rd.,
Caohejing Development Area,

Xuhui District, Shanghai

Tel: +86-21-5169-3609

Fax: +86-21-5445-3266

Information: sales.china@avalue.com.cn

Service: service@avalue.com.tw

Product Warranty

Avalue warrants to you, the original purchaser, that each of its products will be free from defects in materials and workmanship for two years from the date of purchase.

This warranty does not apply to any products which have been repaired or altered by persons other than repair personnel authorized by Avalue, or which have been subject to misuse, abuse, accident or improper installation. Avalue assumes no liability under the terms of this warranty as a consequence of such events. Because of Avalue's high quality-control standards and rigorous testing, most of our customers never need to use our repair service. If any of Avalue's products is defective, it will be repaired or replaced at no charge during the warranty period. For out-of-warranty repairs, you will be billed according to the cost of replacement materials, service time, and freight. Please consult your dealer for more details. If you think you have a defective product, follow these steps:

1. Collect all the information about the problem encountered. (For example, CPU type and speed, Avalue's products model name, hardware & BIOS revision number, other hardware and software used, etc.) Note anything abnormal and list any on-screen messages you get when the problem occurs.
2. Call your dealer and describe the problem. Please have your manual, product, and any helpful information available.
3. If your product is diagnosed as defective, obtain an RMA (return material authorization) number from your dealer. This allows us to process your good return more quickly.
4. Carefully pack the defective product, a complete Repair and Replacement Order Card and a photocopy proof of purchase date (such as your sales receipt) in a shippable container. A product returned without proof of the purchase date is not eligible for warranty service.
5. Write the RMA number visibly on the outside of the package and ship it prepaid to your dealer.

Contents

1. Getting Started	11
1.1 Safety Precautions	11
1.2 Packing List.....	11
1.3 Manual Objectives.....	12
1.4 System Specifications	13
1.5 Architecture Overview – Block Diagram.....	15
2. Hardware Configuration	16
2.1 Product Overview.....	17
2.2 Installation Procedure	18
2.2.1 Main Memory.....	19
2.3 Jumper and Connector List.....	21
2.4 Setting Jumpers & Connectors	24
2.4.1 Clear CMOS (JCMOS1).....	24
2.4.2 CF Master/Slave select (JIDEMS1)	24
2.4.3 COM1/2/3/4/5/6--Ring, +5V, +12V power select (JPC1/2/3/4/5/6, 3 to 6 are optional)	25
2.4.4 JSATA1&JSATA2 Pin7 select (JPSA1&JPSA2).....	25
2.4.5 4/5/8-wire Touch Screen Select & AT/ATX Select (SS1).....	26
2.4.6 ATX Power Connector (JSUS1).....	27
2.4.7 Serial port connector 3/ 4/ 5/ 6 (JCOM3/4/5/6, Optional).....	27
2.4.8 COM1 &COM2 Connector (JCOM1&JCOM2)	28
2.4.9 General purpose I/O connector (JDIO1)	29
2.4.10 LCD Inverter Connector (JINV1/ JINV2).....	29
2.4.11 Touch panel connector (JTP1, Optional).....	30
2.4.12 Backlight brightness adjustment Connector (JVR1)	31
2.4.13 IrDA Connector (JIR1)	32
2.4.14 Power bottom connector (JPB1)	32
2.4.15 IDE Connector (JIDE1)	33
2.4.16 TV-out Connector (JTV1).....	34
2.4.17 Audio Connector (JAUD1)	34
2.4.18 Power Connector (JPWR1).....	35
2.4.19 Fan Connector (JFAN1/ JFAN2).....	35
2.4.20 SPI interface Connector (JSPI1).....	36
2.4.21 PS/2 keyboard & mouse connector (JKBMS2).....	36
2.4.22 SATA1 power input (JPSATA1).....	37
2.4.23 USB connector (JUSB2/ 3)	37
2.4.24 USB connector (JUSB4)	38
2.4.25 LED indicator connector (JLED1)	38

2.4.26	24-bit LVDS/DVI Connector (JDVI1, Optional)	39
2.4.27	18-bit LVDS Connector (JLVDS1)	40
2.4.28	18-bit LVDS Connector (JLVDS2)	41
2.4.29	Print port Connector (JPRT1)	42
3.	BIOS Setup	43
3.1	Starting Setup	44
3.2	Using Setup	45
3.3	Getting Help	46
3.4	In Case of Problems	46
3.5	Main Menu	47
3.5.1	Standard CMOS Features	48
3.5.1.1	Main Menu Selection	48
3.5.1.2	IDE Adapter Setup	49
3.5.2	Advanced BIOS Features	50
3.5.2.1	CPU Feature	50
3.5.2.2	Hard Disk Boot Priority	51
3.5.2.3	Virus Warning	51
3.5.2.4	CPU L1 & L2 & L3 Cache	52
3.5.2.5	Hyper-Threading Technology	52
3.5.2.6	Quick Power On Self Test	52
3.5.2.7	First/Second/Third/Other Boot Device	52
3.5.2.8	Boot Up NumLock Status	52
3.5.2.9	Gate A20 Option	52
3.5.2.10	Typematic Rate Setting	52
3.5.2.11	Typematic Rate (Chars/Sec)	53
3.5.2.12	Typematic Delay (Msec)	53
3.5.2.13	Security Option	53
3.5.2.14	APIC Mode	53
3.5.2.15	MPS Version Control For OS	53
3.5.2.16	OS Select for DRAM > 64MB	53
3.5.2.17	Report No FDD For WIN95	53
3.5.2.18	Small Logo (EPA) Show	54
3.5.3	Advanced Chipset Features	55
3.5.3.1	Onboard – DRAM	55
3.5.3.2	DRAM Timing Selectable	55
3.5.3.3	CAS Latency Time	55
3.5.3.4	DRAM RAS# to CAS# Delay	56
3.5.3.5	DRAM RAS# Precharge	56
3.5.3.6	Precharge Delay (tRAS)	56
3.5.3.7	System Memory Frequency	56

EBM-945GSE

3.5.3.8	System BIOS Cacheable	56
3.5.3.9	Video BIOS Cacheable	56
3.5.3.10	Memory Hole At 15M-16M	57
3.5.3.11	PCI Express Root	57
3.5.3.11.1	PCI-E Compliancy Mode	57
3.5.3.12	VGA Setting	58
3.5.4	Integrated Peripherals	60
3.5.4.1	OnChip IDE Device	60
3.5.4.1.1	On-Chip Serial ATA Setting	61
3.5.4.2	Onboard Device	62
3.5.4.3	Super IO Device	63
3.5.4.4	PWRON After PWR-Fail	63
3.5.4.5	Watch Dog Timer	63
3.5.4.6	USB Device Setting	64
3.5.5	Power Management Setup	65
3.5.5.1	PCI Express PM Function	65
3.5.5.2	ACPI Function	65
3.5.5.3	ACPI Suspend Type	65
3.5.5.4	Run VGABIOS if S3 Resume	65
3.5.5.5	Power Management	65
3.5.5.6	Video Off Method	66
3.5.5.7	Video Off In Suspend	66
3.5.5.8	Suspend Type	66
3.5.5.9	MODEM Use IRQ	66
3.5.5.10	Suspended Mode	66
3.5.5.11	HDD Power Down	66
3.5.5.12	Soft-Off by PWR-BTTN	66
3.5.5.13	Wake Up by PCI Card	66
3.5.5.14	Power On By Ring	66
3.5.5.15	Resume By Alarm	66
3.5.5.16	Date<of Month>/Time<hh:mm:ss> Alarm	67
3.5.5.17	Primary/Secondary IDE 0/1, FDD,COM,LPT PORT, PCI PIRQ[A-D]#	67
3.5.6	PnP / PCI Configuration	67
3.5.6.1	Init Display First	67
3.5.6.2	Reset Configuration Data	68
3.5.6.3	Resources Controlled By	68
3.5.6.4	PCI / VGA Palette Snoop	68
3.5.6.5	INT Pin 1/2/3/4/5/6/7/8 Assignment	68
3.5.6.6	Maximum Payload Size	68
3.5.7	PC Health Status	69

3.5.8	Frequency/ Voltage Control	70
3.5.9	Load Fail-Safe Defaults	70
3.5.10	Load Optimized Defaults	71
3.5.11	Set Supervisor / User Password	72
3.5.12	Save & Exit Setup	74
3.5.13	Exit Without Save	75
4.	Drivers Installation.....	76
4.1	Install Chipset Driver (For Intel 945GSE)	77
4.2	Install Display Driver (For Intel 945GSE)	78
4.3	Install Ethernet Driver (For Realtek RTL8111C).....	79
4.4	Install Audio Driver (For Realtek ALC655)	80
5.	Mechanical drawing.....	81
Appendix A: AWARD BIOS POST Messages		84
Overview.....		85
Post Beep		85
Error Messages		85
1.	CMOS BATTERY HAS FAILED	85
2.	CMOS CHECKSUM ERROR	85
3.	DISK BOOT FAILURE, INSERT SYSTEM DISK AND PRESS ENTER	85
4.	DISKETTE DRIVES OR TYPES MISMATCH ERROR - RUN SETUP	85
5.	DISPLAY SWITCH IS SET INCORRECTLY	86
6.	DISPLAY TYPE HAS CHANGED SINCE LAST BOOT	86
7.	EISA Configuration Checksum Error PLEASE RUN EISA CONFIGURATION UTILITY	86
8.	EISA Configuration Is Not Complete PLEASE RUN EISA CONFIGURATION UTILITY	86
9.	ERROR ENCOUNTERED INITIALIZING HARD DRIVE.....	86
10.	ERROR INITIALIZING HARD DISK CONTROLLER	86
11.	FLOPPY DISK CNTRLR ERROR OR NO CNTRLR PRESENT	86
12.	Invalid EISA Configuration PLEASE RUN EISA CONFIGURATION UTILITY	87
13.	KEYBOARD ERROR OR NO KEYBOARD PRESENT	87
14.	Memory Address Error at	87
15.	Memory parity Error at	87
16.	MEMORY SIZE HAS CHANGED SINCE LAST BOOT	87
17.	Memory Verify Error at	87
18.	OFFENDING ADDRESS NOT FOUND	87
19.	OFFENDING SEGMENT:	87
20.	PRESS A KEY TO REBOOT	88
21.	PRESS F1 TO DISABLE NMI, F2 TO REBOOT	88
22.	RAM PARITY ERROR - CHECKING FOR SEGMENT	88
23.	Should Be Empty But EISA Board Found PLEASE RUN EISA CONFIGURATION UTILITY	88
24.	Should Have EISA Board But Not Found PLEASE RUN EISA CONFIGURATION UTILITY	88

EBM-945GSE

25.	Slot Not Empty	88
26.	SYSTEM HALTED, (CTRL-ALT-DEL) TO REBOOT	88
27.	Wrong Board In Slot PLEASE RUN EISA CONFIGURATION UTILITY	89
28.	FLOPPY DISK(S) fail (80) → Unable to reset floppy subsystem.....	89
29.	FLOPPY DISK(S) fail (40) → Floppy Type mismatch.....	89
30.	Hard Disk(s) fail (80) → HDD reset failed.....	89
31.	Hard Disk(s) fail (40) → HDD controller diagnostics failed.....	89
32.	Hard Disk(s) fail (20) → HDD initialization error.....	89
33.	Hard Disk(s) fail (10) → Unable to recalibrate fixed disk.....	89
34.	Hard Disk(s) fail (08) → Sector Verify failed.....	89
35.	Keyboard is locked out - Unlock the key.....	89
36.	Keyboard error or no keyboard present.....	89
37.	Manufacturing POST loop.....	89
38.	BIOS ROM checksum error - System halted.....	89
39.	Memory test fail.....	89
40.	POST Codes	90
40.1	Normal POST Code.....	90
40.2	Quick POST Codes.....	96
40.3	S4 POST Codes	98
40.4	BootBlock POST Codes.....	99

1. Getting Started

1.1 Safety Precautions

Warning!



Always completely disconnect the power cord from your chassis whenever you work with the hardware. Do not make connections while the power is on. Sensitive electronic components can be damaged by sudden power surges. Only experienced electronics personnel should open the PC chassis.

Caution!



Always ground yourself to remove any static charge before touching the CPU card. Modern electronic devices are very sensitive to static electric charges. As a safety precaution, use a grounding wrist strap at all times. Place all electronic components in a static-dissipative surface or static-shielded bag when they are not in the chassis.

1.2 Packing List

Before you begin installing your single board, please make sure that the following materials have been shipped:

- 1 x Intel 945GSE Mini Module
- 1 x Quick Installation Guide for EBM-945GSE
- 1 x DVD-ROM contains the followings:
 - User's Manual (this manual in PDF file)
 - Ethernet driver and utilities
 - VGA drivers and utilities
 - Audio drivers and utilities
- 1 x Cable set contains the followings:
 - 1 x IDE HDD cable (44-pin, pitch 2.0mm)
 - 1 x Serial ATA cables (7-pin, standard)



If any of the above items is damaged or missing, contact your retailer.

1.3 Manual Objectives

This manual describes in detail the Avalue Technology EBM-945GSE Single Board.





We have tried to include as much information as possible but we have not duplicated information that is provided in the standard IBM Technical References, unless it proved to be necessary to aid in the understanding of this board.

We strongly recommend that you study this manual carefully before attempting to interface with EBM-945GSE series or change the standard configurations. Whilst all the necessary information is available in this manual we would recommend that unless you are confident, you contact your supplier for guidance.



Please be aware that it is possible to create configurations within the CMOS RAM that make booting impossible. If this should happen, clear the CMOS settings, (see the description of the Jumper Settings for details).

If you have any suggestions or find any errors concerning this manual and want to inform us of these, please contact our Customer Service department with the relevant details.

1.4 System Specifications

System 	
CPU	Onboard Intel N270 Atom processor 1.6GHz, (2.5W)
FSB	533 MHz
BIOS	Award 8 Mbit Flash BIOS
System Chipset	Intel® 945GSE / ICH7-M
I/O Chip	ITE 8712F
System Memory	Onboard 1GB DDR2, extra one 200-pin DDR2 SODIMM supports up to 2GB 400/533 SDRAM
SSD	One CompactFlash Type I/II socket
Watchdog Timer	Reset: 1~65535 sec./min and 1 min./step
Expansion	1 x Mini PCI, one optional Mini PCI-E slot
I/O 	
MIO	1 x EIDE by 44-pin IDE connector, 2 x SATA 2 x RS-232/422/485 (COM1 DB-9, COM2 pin header, setting by BIOS) 4 x RS-232 (COM3~6) COM1~6 pin-9 RI/+5V/+12V setting by jump 1 x K/B & Mouse (Co-lay with LAN2)
USB	6 x USB 2.0 ports
DIO	16-bit General Purpose I/O for DI and DO
IrDA	Supports one IrDA Tx/Rx header
Touch Interface	ETP-CP-S458XRU support 4,5,8 wire
Display 	
Chipset	Intel® 945GSE Integrated
Display Memory	Intel® DVMT 3.0 Supports up to 224 MB Shared Video Memory
Resolution	CRT mode: 2048 x 1536 @ 75 Hz LCD/Simultaneous mode (4:3): 1600 x 1200 @ 60 Hz
Dual Display	CRT + LVDS, CRT + TV-out, CRT +DVI
LVDS	Dual-CH 18-bit LVDS / Optional Dual-CH 18/24 bit LVDS
DVI	Chrontel CH7307 SDVO to DVI transmitter
TV-out	Intel® 945GSE Integrated TV-out Interface Supports HDTV
Audio 	
Chipset	Intel® ICH7-M
AC97 Codec	Realtek ALC655 supports 5.1 CH Audio
Audio Interface	Mic in, Line in, Speak out (2W)

EBM-945GSE

Ethernet 	
LAN	Dual RealTek RTL8111C Gigabit LAN
Ethernet Interface	1000 Base-Tx Gigabit Ethernet Compatible
Mechanical & Environmental 	
Power Requirement	+12 V, +5 Vsb (for ATX only)
Power Type	Single Power AT / ATX
Operation Temperature	0~60°C (32~140°F)
Operating Humidity	0%~90% relative humidity, non-condensing
Size (L x W)	5.7" x 4.2" (146 mm x 105 mm)
Weight	0.44 lbs (0.2 Kg)

1.5 Architecture Overview – Block Diagram

The following block diagram shows the architecture and main components of EBM-945GSE.

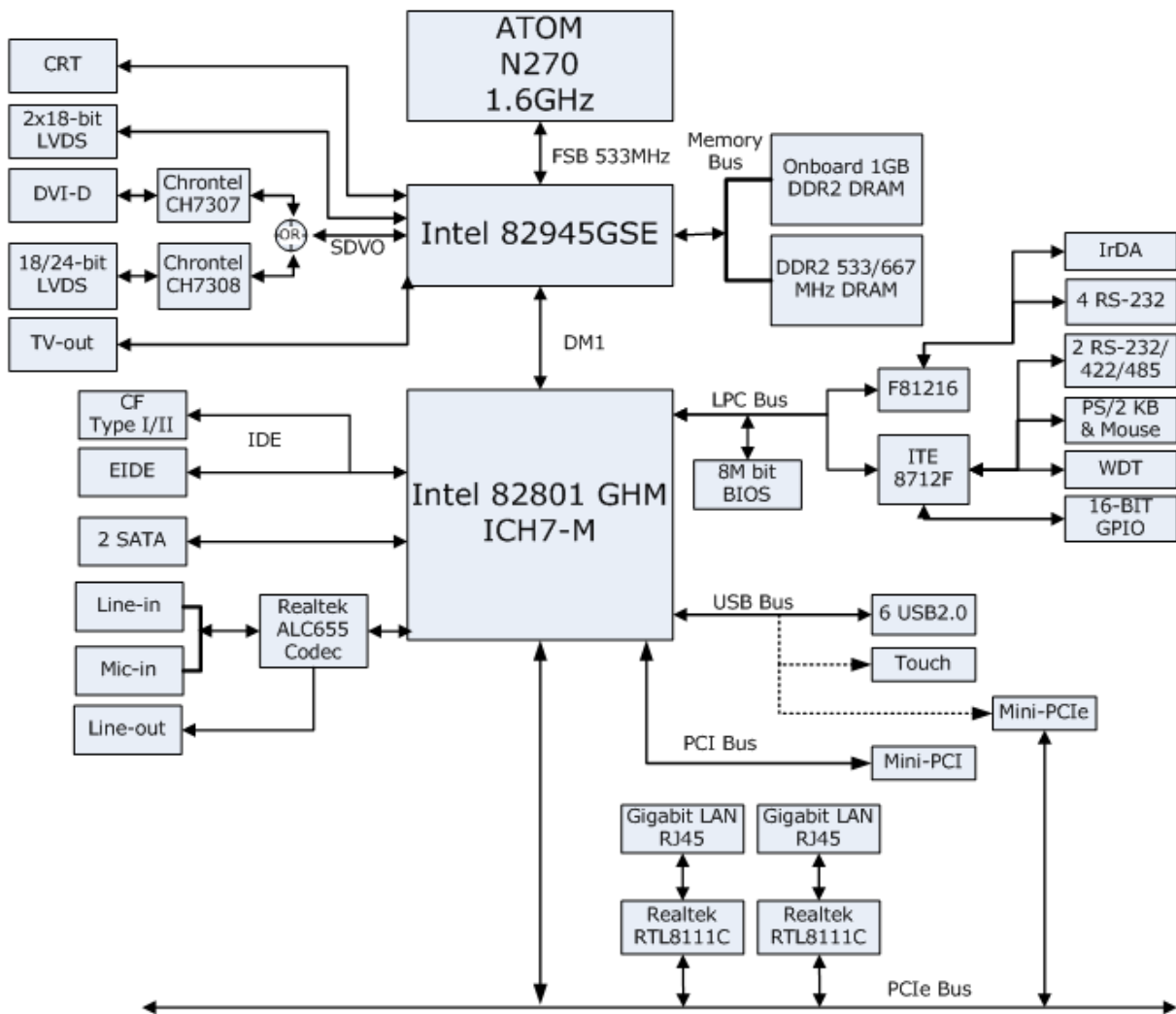

2. Hardware Configuration

2.1 Product Overview

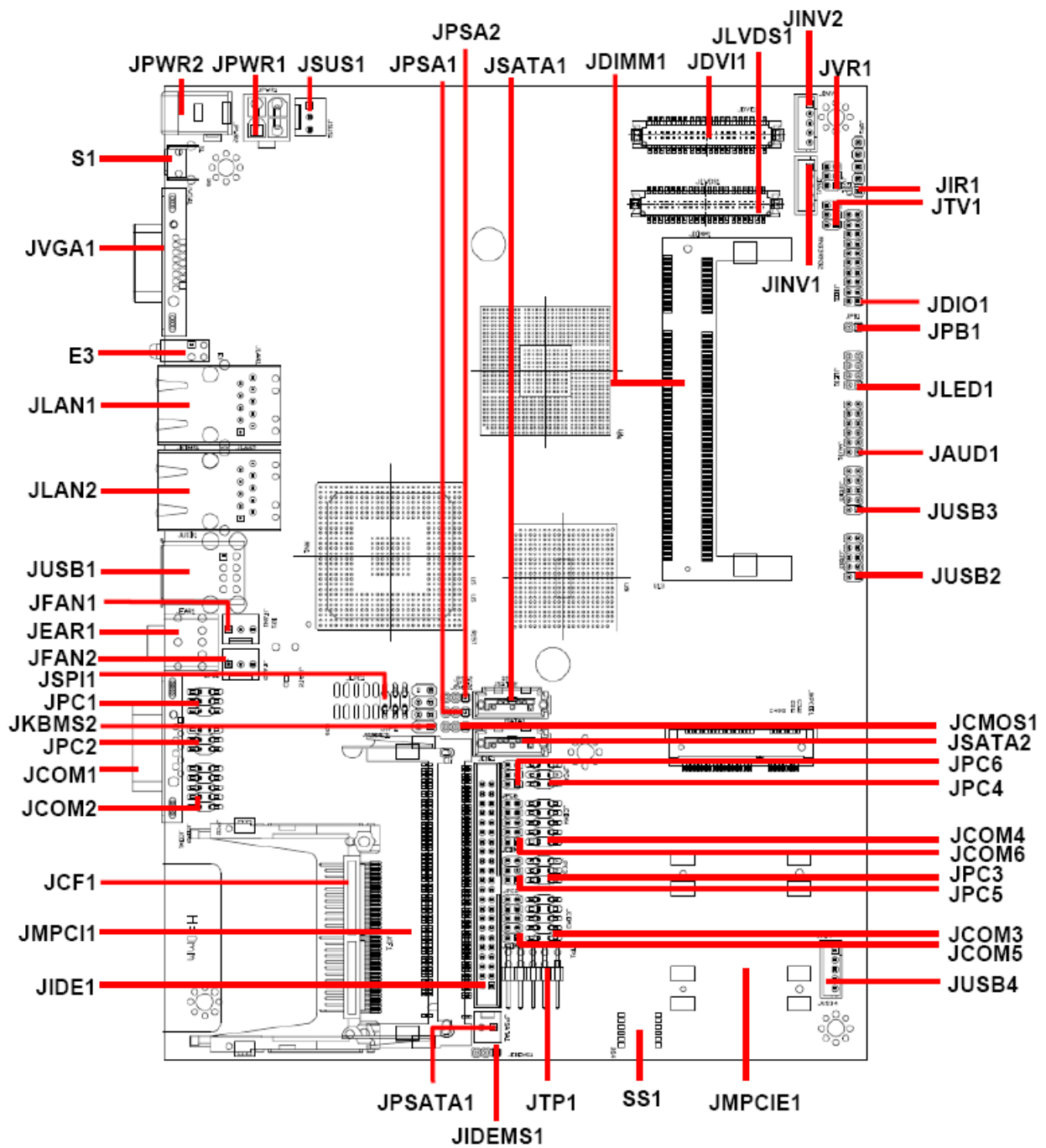

2.2 Installation Procedure

This chapter explains you the instructions of how to setup your system.

1. Turn off the power supply.
2. Insert the SODIMM module (be careful with the orientation).
3. Insert all external cables for hard disk, floppy, keyboard, mouse, USB etc. except for flat panel. A CRT monitor must be connected in order to change CMOS settings to support flat panel.
4. Connect power supply to the board via the ATXPWR.
5. Turn on the power.
6. Enter the BIOS setup by pressing the delete key during boot up. Use the "LOAD BIOS DEFAULTS" feature. The *Integrated Peripheral Setup* and the *Standard CMOS Setup* Window must be entered and configured correctly to match the particular system configuration.
7. If TFT panel display is to be utilized, make sure the panel voltage is correctly set before connecting the display cable and turning on the power.

2.2.1 Main Memory

EBM-945GM provides one 200-pin SODIMM sockets to support DDR2 SDRAM. The total maximum memory size is 2GB.

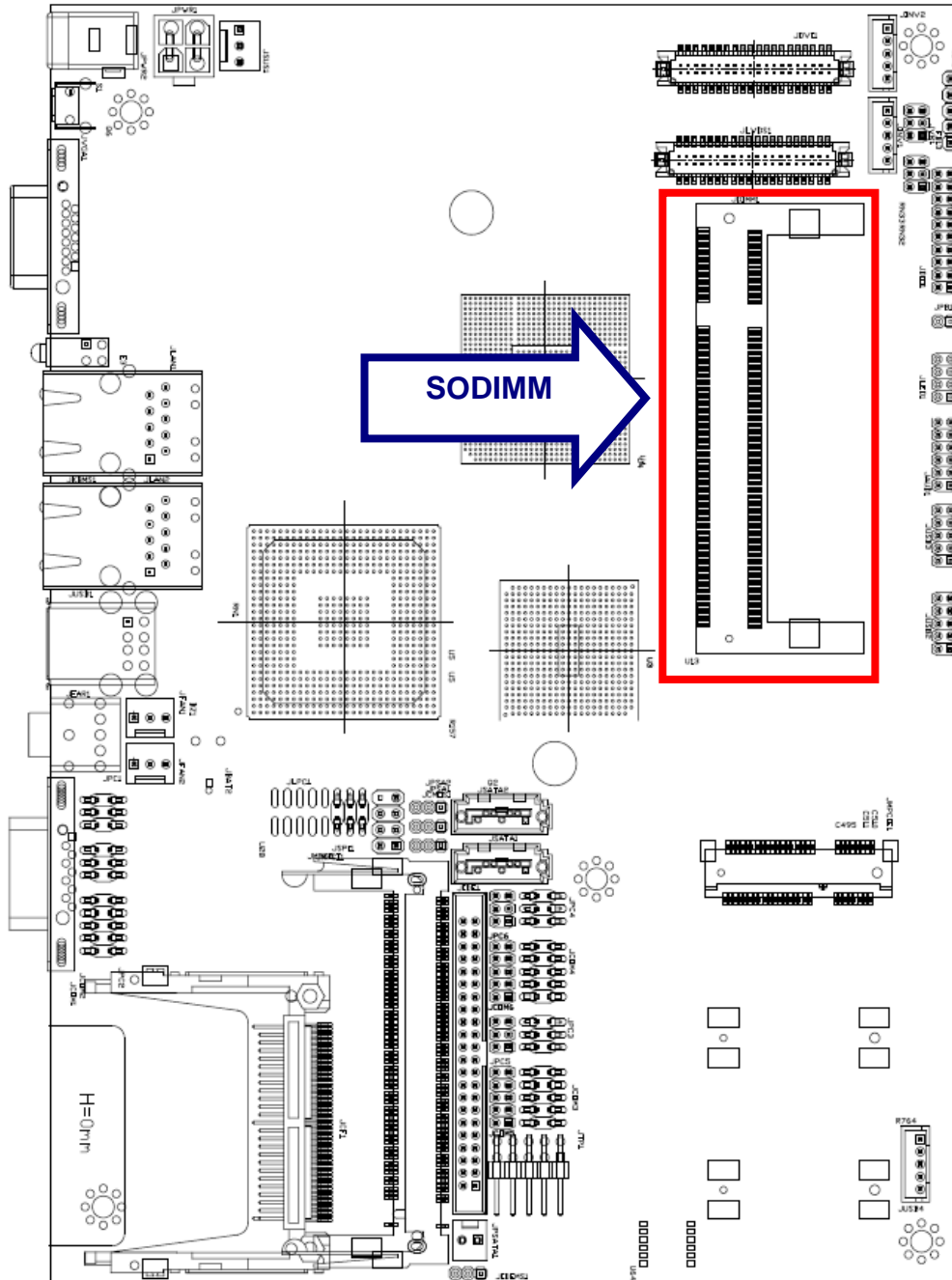

Make sure to unplug the power supply before adding or removing SODIMMs or other system components. Failure to do so may cause severe damage to both the board and the components.

EBM-945GSE

- Locate the SODIMM socket on the board.
- Hold two edges of the SODIMM module carefully. Keep away of touching its connectors.
- Align the notch key on the module with the rib on the slot.
- Firmly press the modules into the socket automatically snaps into the mounting notch. Do not force the SODIMM module in with extra force as the SODIMM module only fit in one direction.

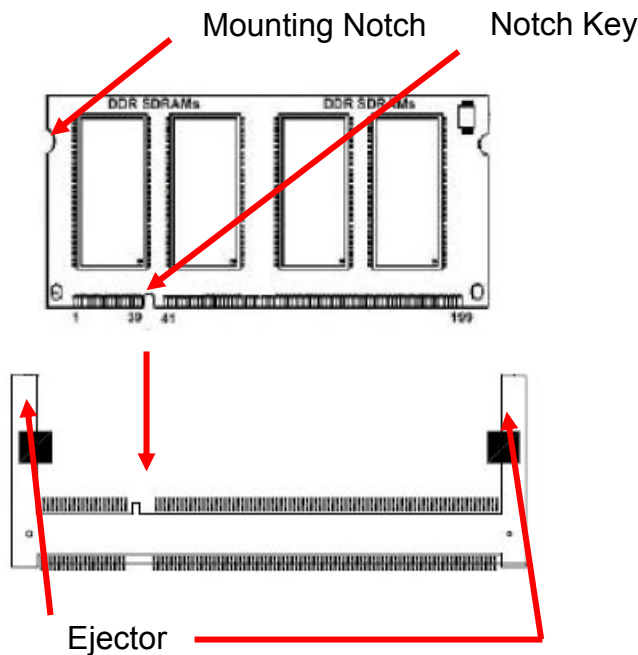

200-pin DDRSODIMM

- To remove the SODIMM modules, push the two ejector tabs on the slot outward simultaneously, and then pull out the SODIMM module.



Note:

- (1) Please do not change any DDR2 SDRAM parameter in BIOS setup to increase your system's performance without acquiring technical information in advance.
- (2) Static electricity can damage the electronic components of the computer or optional boards. Before starting these procedures, ensure that you are discharged of static electricity by touching a grounded metal object briefly.

2.3 Jumper and Connector List

You can configure your board to match the needs of your application by setting jumpers. A jumper is the simplest kind of electric switch.

It consists of two metal pins and a small metal clip (often protected by a plastic cover) that slides over the pins to connect them. To “close” a jumper you connect the pins with the clip. To “open” a jumper you remove the clip. Sometimes a jumper will have three pins, labeled 1, 2, and 3. In this case, you would connect either two pins.

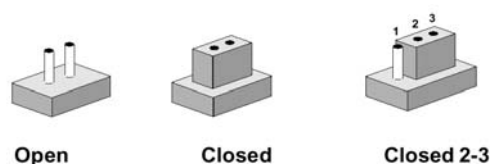

The jumper settings are schematically depicted in this manual as follows:



A pair of needle-nose pliers may be helpful when working with jumpers.

Connectors on the board are linked to external devices such as hard disk drives, a keyboard, or floppy drives. In addition, the board has a number of jumpers that allow you to configure your system to suit your application.

If you have any doubts about the best hardware configuration for your application, contact your local distributor or sales representative before you make any changes.

The following tables list the function of each of the board's jumpers and connectors.

Jumpers

Label	Function	Note
JCMOS1	Clear CMOS	3 x 1 header, pitch 2.0mm
JIDEMS1	CF Master/Slave Select	3 x 1 header, pitch 2.0mm
JPC1	COM1--Ring, +5V, +12V power select	3 x 2 header, pitch 2.0mm
JPC2	COM2--Ring, +5V, +12V power select	3 x 2 header, pitch 2.0mm
JPC3	COM3--Ring, +5V, +12V power select (Optional)	3 x 2 header, pitch 2.0mm
JPC4	COM4--Ring, +5V, +12V power select (Optional)	3 x 2 header, pitch 2.0mm
JPC5	COM5--Ring, +5V, +12V power select (Optional)	3 x 2 header, pitch 2.0mm
JPC6	COM6--Ring, +5V, +12V power select (Optional)	3 x 2 header, pitch 2.0mm
JPSA1	JSATA1 Pin7 select	3 x 1 header, pitch 2.0mm
JPSA2	JSATA2 Pin7 select	3 x 1 header, pitch 2.0mm

Connectors

Label	Function	Note
E3	LED connector	
JCF1	Compact Flash card connector	
JCOM1	Serial Port 1 connector	
JCOM2	Serial Port 2 connector	5 x 2 header, pitch 2.0mm
JCOM3	Serial Port 3 connector (Optional)	5 x 2 header, pitch 2.0mm
JCOM4	Serial Port 4 connector (Optional)	5 x 2 header, pitch 2.0mm
JCOM5	Serial Port 5 connector (Optional)	5 x 2 header, pitch 2.0mm
JCOM6	Serial Port 6 connector (Optional)	5 x 2 header, pitch 2.0mm
JDIMM1	200-pin DDR2 SODIMM socket	
JDIO1	General purpose I/O connector	10 x 2 header, pitch 2.0mm
JDVI1	DVI Connector (Optional)	HIROSE DF13-40DP-1.25V
JEAR1	Audio Connector	
JIDE1	Primary IDE connector	22 x 2 header, pitch 2.0mm
JINV1	LCD Inverter Connector	5 x 1 wafer, pitch 2.0mm
JINV2	LCD Inverter Connector	5 x 1 wafer, pitch 2.0mm
JIR1	IrDA connector	5 x 1 header, pitch 2.54mm
JKBMS2	PS/2 keyboard & mouse connector	4 x 2 header, pitch 2.54mm
JLAN1	RJ-45 Ethernet 1	
JLAN2	RJ-45 Ethernet 2	
JLED1	LED indicator connector	
JLVDS1	LVDS Connector 1	HIROSE DF13-40DP-1.25V
JLVDS2	LVDS Connector 2	HIROSE DF13-40DP-1.25V
JMPCI1	Mini-PCI connector	
JMPCIE1	Mini-PCIe slot	
JAUD1	Audio connector	6 x 2 header, pitch 2.0mm
JPB1	Power bottom connector	2 x 1 header, pitch 2.0mm
JPSATA1	SATA1 power input	2 x 1 wafer, pitch 2.54mm
JPWR1	Power connector	2 x 2 wafer, pitch 4.2mm
JPWR2	Power connector	
JPRT1	Print port connector (Optional)	
JSATA1&2	Serial ATA connector 1&2	Wafer 7P pitch 1.27mm
JSUS1	ATX Power connector	3 x 1 wafer, pitch 2.54mm
JSPI1	SPI interface connector	3 x 2 header, pitch 2.0mm

JFAN1&2	Fan connector	3 x 1 wafer, pitch 2.54mm
JTP1	Touch panel connector (Optional)	5 x 2 header, pitch 2.54mm
JUSB1	USB connector 0 & 1	
JUSB2	USB connector 2 & 3	5 x 2 header, pitch 2.0mm
JUSB3	USB connector 4 & 5	5 x 2 header, pitch 2.0mm
JUSB4	USB connector 7	5 x 2 header, pitch 2.0mm
JVGA1	VGA connector	
JVR1	LCD backlight brightness adjustment	3 x 2 header, pitch 2.0mm
JTV1	TV-out connector	3 x 2 header, pitch 2.0mm
S1	Reset/Power bottom	
SS1	4/5/8-wire Touch Screen Select & AT/ATX Select	DIP SW-6

2.4 Setting Jumpers & Connectors

2.4.1 Clear CMOS (JCMOS1)

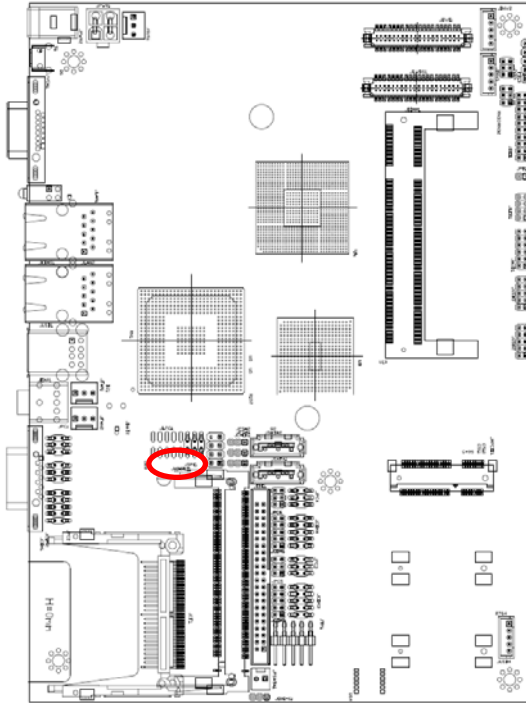

* Default

Protect*

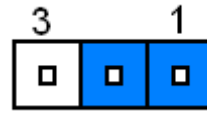

Clear CMOS

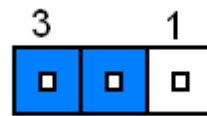

2.4.2 CF Master/Slave select (JIDEMS1)

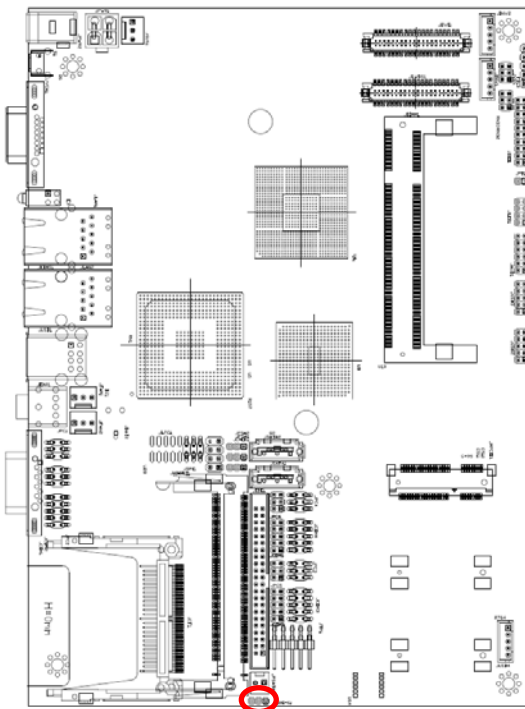

* Default

Master*

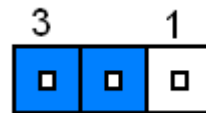

Slave

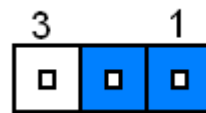

2.4.3 COM1/2/3/4/5/6--Ring, +5V, +12V power select (JPC1/2/3/4/5/6, 3 to 6 are optional)

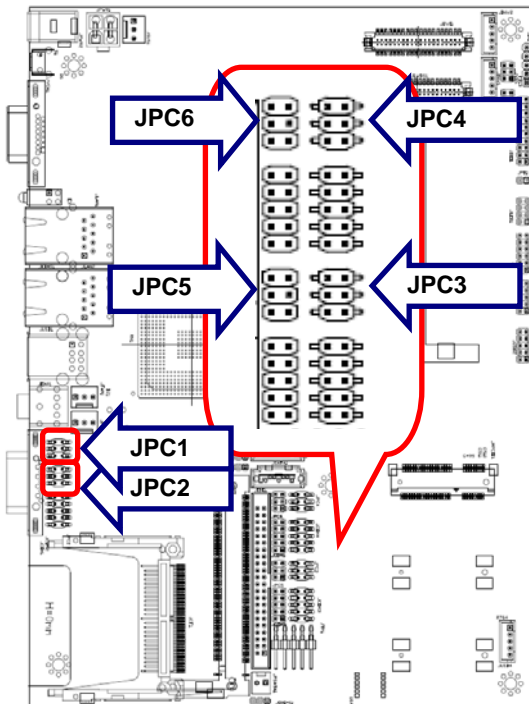

* Default

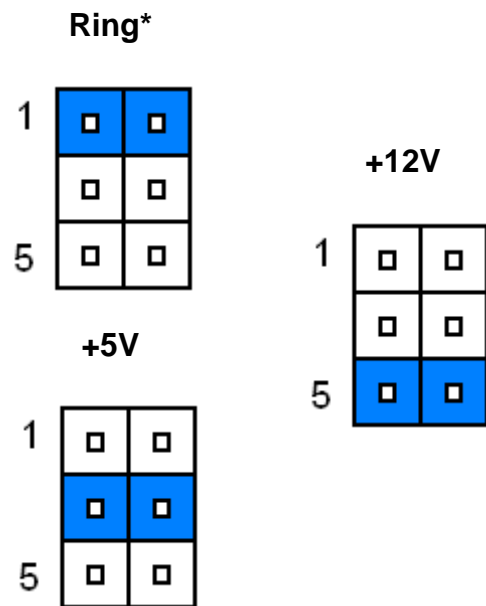

2.4.4 JSATA1&JSATA2 Pin7 select (JPSA1&JPSA2)

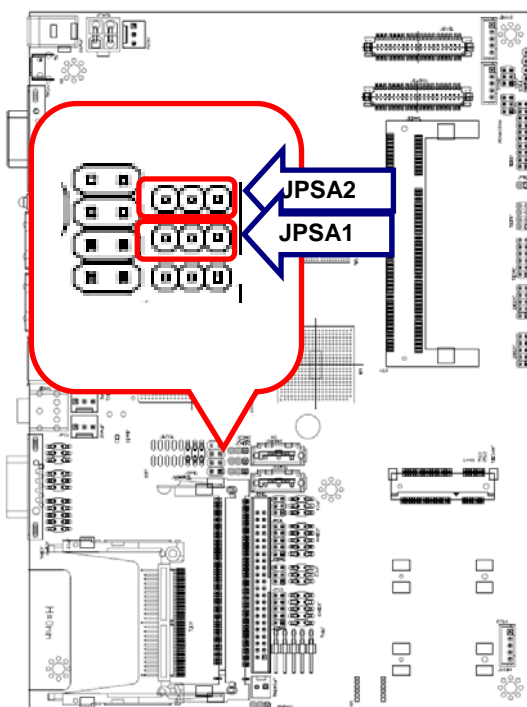

* Default

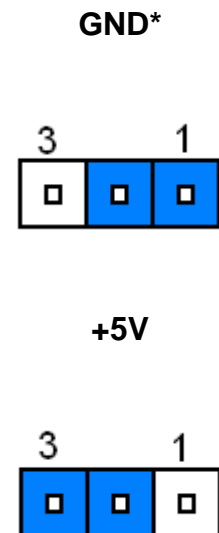

EBM-945GSE

2.4.5 4/5/8-wire Touch Screen Select & AT/ATX Select (SS1)

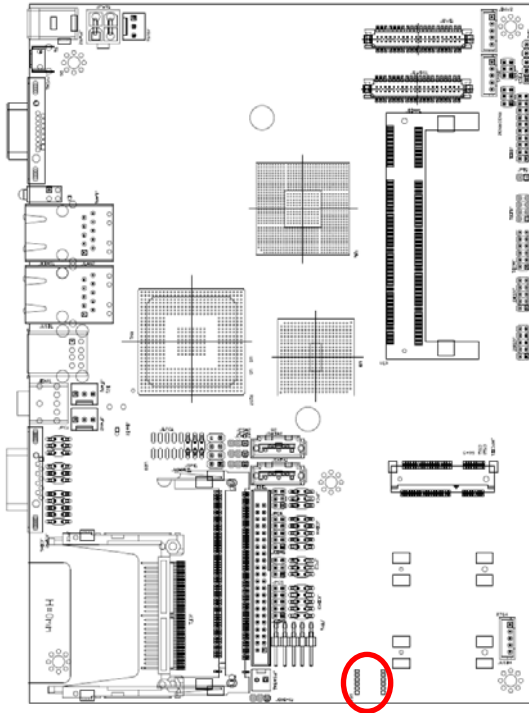

AT/ATX Select

	AT	ATX
SW6	ON	OFF

ATX

OFF	6	←	ON
-----	---	---	----

AT

OFF	6	→	ON
-----	---	---	----

4/5/8-wire Touch Screen Select

	4W	5W	8W
SW1	ON	OFF	ON
SW2	ON	ON	OFF
SW3	ON	ON	OFF
SW4	ON	ON	OFF
SW5	ON	ON	OFF

5-wire

OFF	1	←	ON
	2	→	
	3	→	
	4	→	
	5	→	
	6		

4-wire

OFF	1	→	ON
	2	→	
	3	→	
	4	→	
	5	→	
	6		

8-wire

OFF	1	→	ON
	2	←	
	3	←	
	4	←	
	5	←	
	6		

2.4.6 ATX Power Connector (JSUS1)

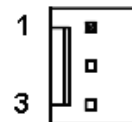
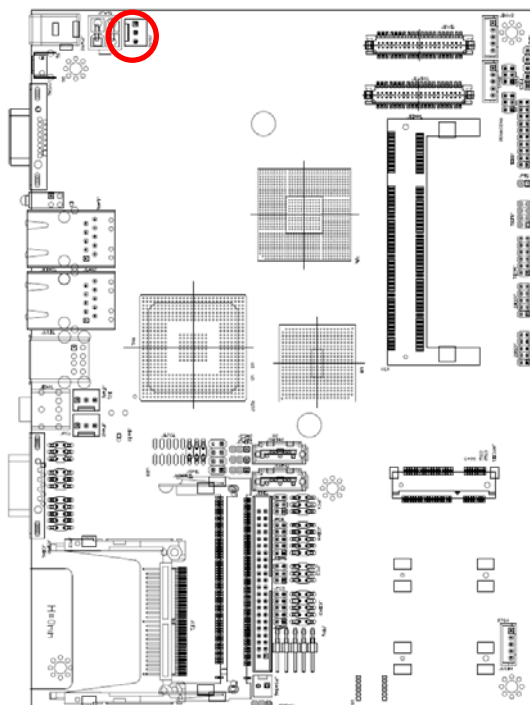

Signal	PIN
PS-ON	1
NC	2
+5VSB	3

2.4.7 Serial port connector 3/ 4/ 5/ 6 (JCOM3/4/5/6, Optional)

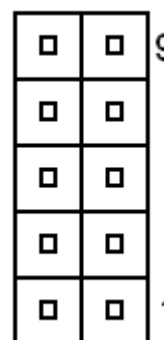
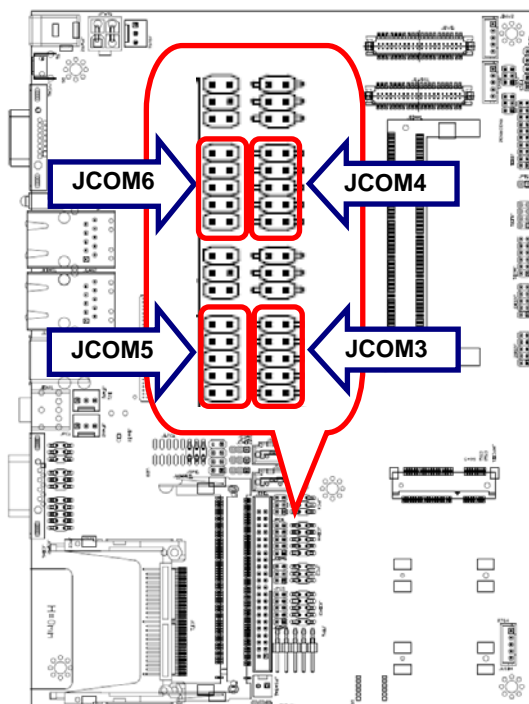

Signal	PIN	PIN	Signal
NC	10	9	RI
CTS	8	7	RTS
DSR	6	5	GND
DTR	4	3	TxD
RxD	2	1	DCD

EBM-945GSE

2.4.8 COM1 & COM2 Connector (JCOM1&JCOM2)

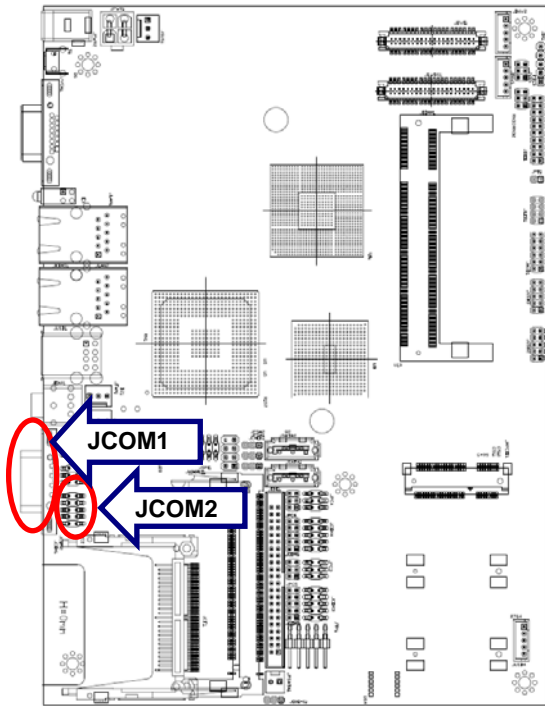

JCOM2

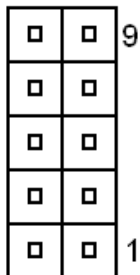

RS-232 Mode

Signal	PIN	PIN	Signal
NC	10	9	RI
CTS	8	7	RTS
DSR	6	5	GND
DTR	4	3	TxD
RxD	2	1	DCD

RS-422 Mode

Signal	PIN	PIN	Signal
GND	10	9	GND
RxD-	8	7	NC
TxD+	6	5	GND
NC	4	3	NC
RxD+	2	1	TxD-

RS-485 Mode

Signal	PIN	PIN	Signal
GND	10	9	GND
NC	8	7	NC
DATA+	6	5	GND
NC	4	3	NC
NC	2	1	DATA-

2.4.9 General purpose I/O connector (JDIO1)

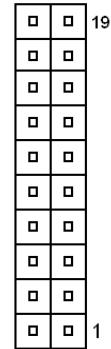
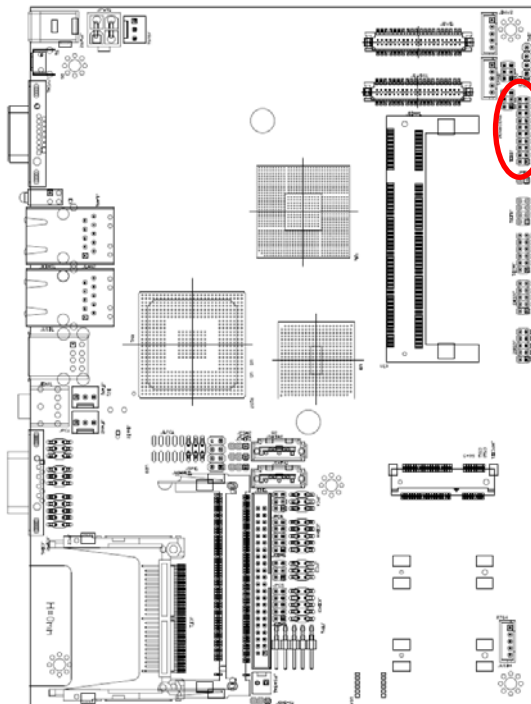

Signal	PIN	PIN	Signal
+5V	20	19	GND
SMB_DATA	18	17	SMB_CLK
GPIO37	16	15	GPIO27
GPIO36	14	13	GPIO26
GPIO35	12	11	GPIO25
GPIO34	10	9	GPIO24
GPIO33	8	7	GPIO23
GPIO32	6	5	GPIO22
GPIO31	4	3	GPIO21
GPIO30	2	1	GPIO20

2.4.10 LCD Inverter Connector (JINV1/ JINV2)

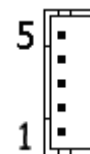
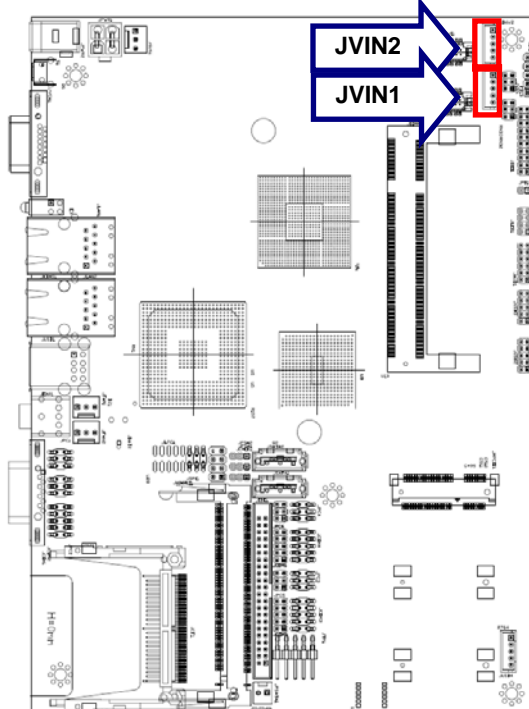

Signal	PIN
+5V	5
VR	4
ENBKL	3
GND	2
+12V	1

EBM-945GSE

2.4.11 Touch panel connector (JTP1, Optional)

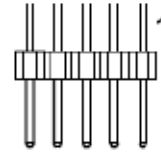
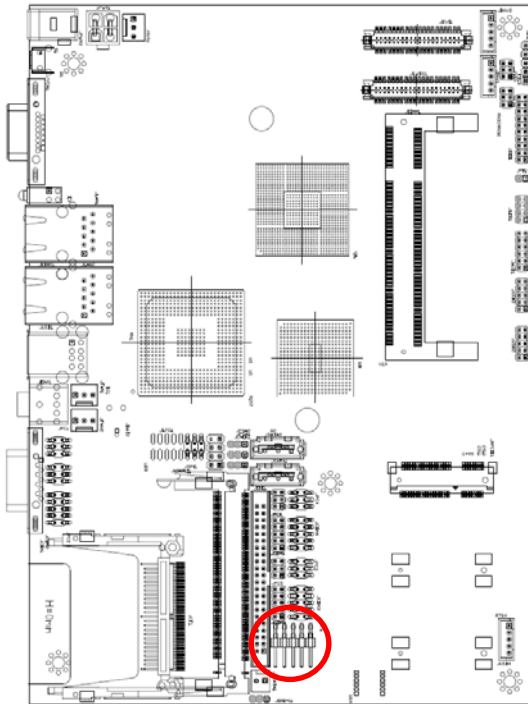

Signal	PIN	PIN	Signal
X+	1	2	X+2
Y+	3	4	Y+2
PROBE	5	6	GND
Y-	7	8	Y-2
X-	9	10	X-2

4/5/8-wire Touch Screen Select

Wire	Select
4	2, 4, 8, 10
5	2, 4, 6, 8, 10
8	1, 2, 3, 4, 6, 7, 8, 9, 10

2.4.12 Backlight brightness adjustment Connector (JVR1)

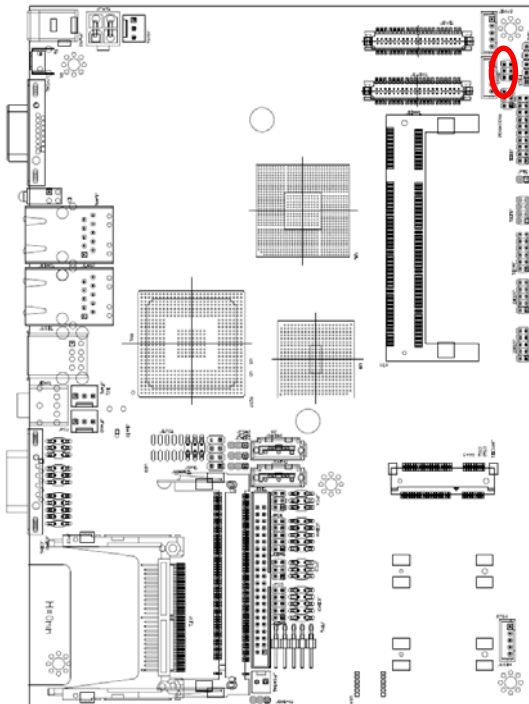

Mode1: VR type

Signal	PIN	PIN	Signal
+5V	1	2	INV_DA
VR	3	4	VR
GND	5	6	INV_PWM

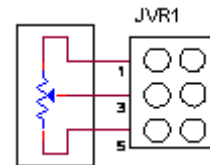

Variation Resistor

(Recommended: 4.7KΩ, >1/16W)

Mode2: Digital to Analogue type*

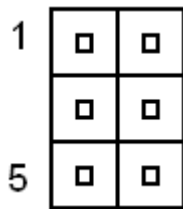
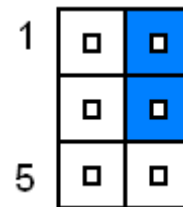

* Default

Mode3: Pulse-Width Modulated type

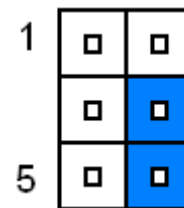

Note:

For inverters with adjustable Backlight function, it is possible to control the LCD brightness through the VR signal controlled by JVR1. Please see the JVR1 section for detailed circuitry information.

EBM-945GSE

2.4.13 IrDA Connector (JIR1)

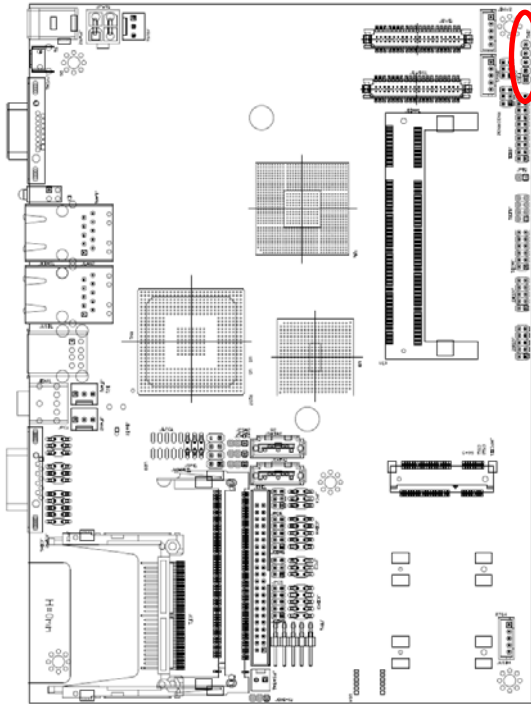

Signal	PIN
IRTX	5
GND	4
IRRX	3
NC	2
+5V	1



Note:

When using JIR1, it is necessary to give up JCOM3/ RS232 function.

2.4.14 Power bottom connector (JPB1)

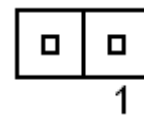
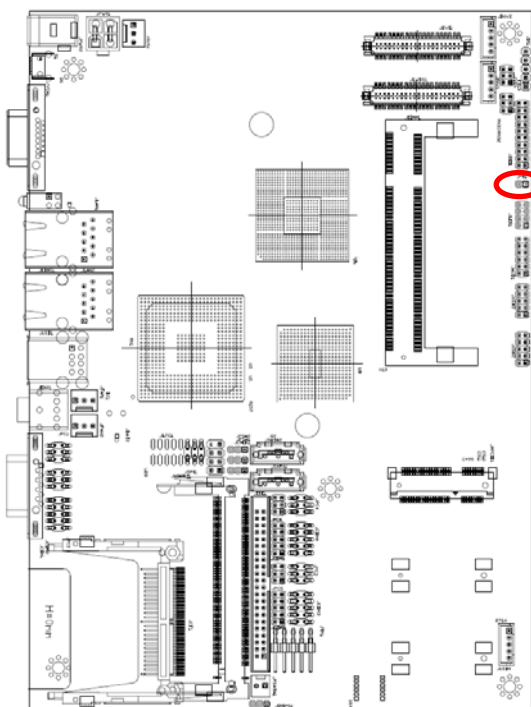

Signal	PIN
PWR-BT	1
GND	2

2.4.15 IDE Connector (JIDE1)

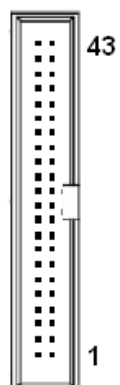
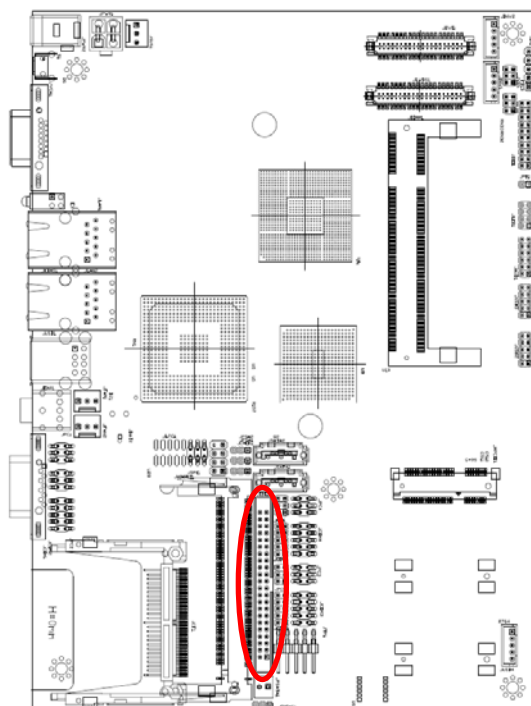

Signal	PIN	PIN	Signal
RESET#	1	2	GND
PDD7	3	4	PDD8
PDD6	5	6	PDD9
PDD5	7	8	PDD10
PDD4	9	10	PDD11
PDD3	11	12	PDD12
PDD2	13	14	PDD13
PDD1	15	16	PDD14
PDD0	17	18	PDD15
GND	19	20	NC
PDREQ	21	22	GND
PDIOW#	23	24	GND
PDIOR#	25	26	GND
PIORDY	27	28	CSEL
PDAK#	29	30	GND
IRQ15	31	32	NC
PDA1	33	34	LID
PDA0	35	36	PDA2
PDCS1#	37	38	PDCS3#
HD_LED1	39	40	GND
+5V	41	42	+5V
GND	43	44	NC

EBM-945GSE

2.4.16 TV-out Connector (JTV1)

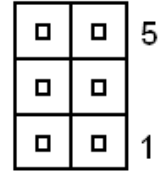
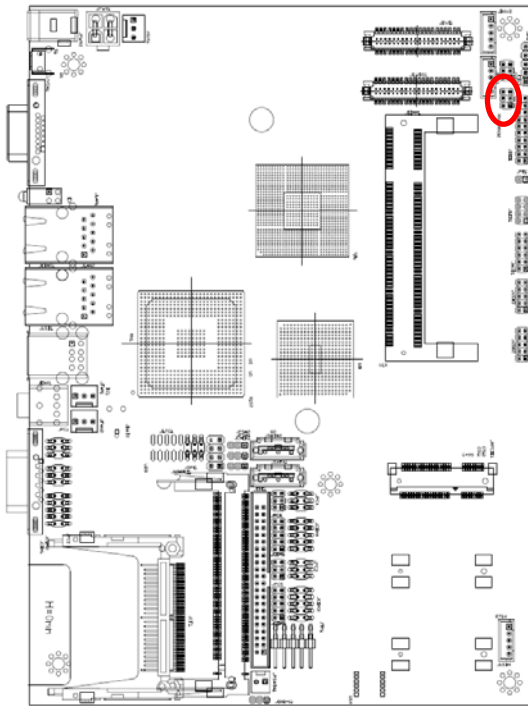

Signal	PIN	PIN	Signal
GND	6	5	GND
PR/C	4	3	Y/Y
GND	2	1	PB/CVBS

2.4.17 Audio Connector (JAUD1)

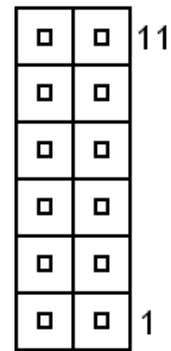
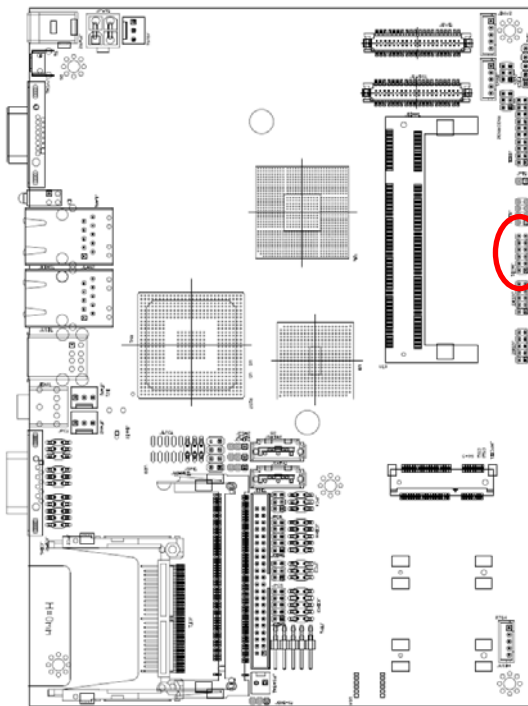

Signal	PIN	PIN	Signal
GND	12	11	MIC_JD
LINEIN_JD	10	9	LINEOUT_JD
AUD_MICL	8	7	AUD_MICR
AUD_LINEL	6	5	AUD_LINER
GND	4	3	GND
AUD_OUTL	2	1	AUD_OUTR

2.4.18 Power Connector (JPWR1)

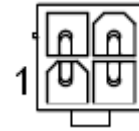
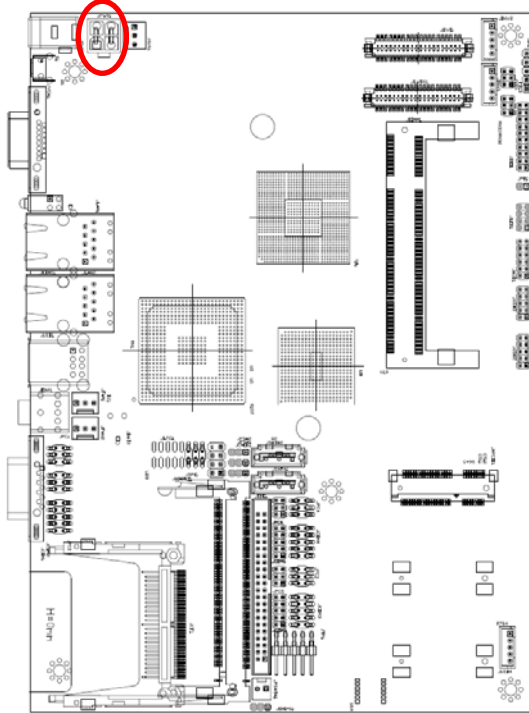

Signal	PIN	PIN	Signal
GND	3	4	GND
VIN	1	2	VIN

2.4.19 Fan Connector (JFAN1/ JFAN2)

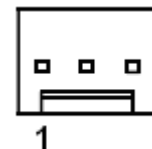
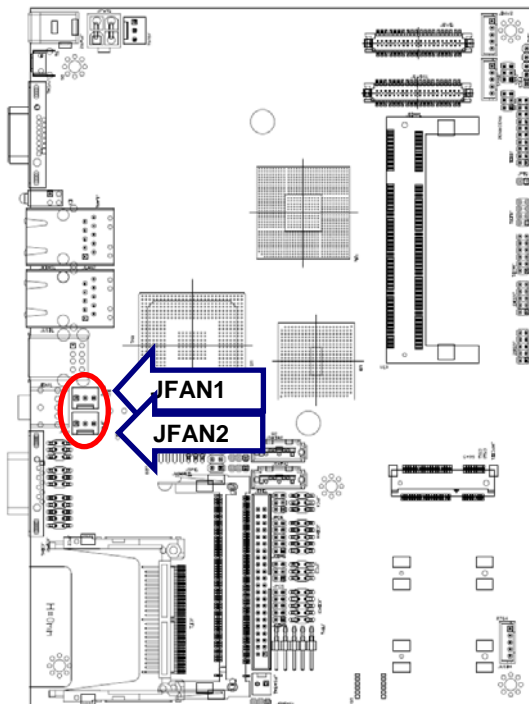

Signal	PIN
GND	1
+12V	2
FAN_TAC1/ FAN_TAC2	3

EBM-945GSE

2.4.20 SPI interface Connector (JSPI1)

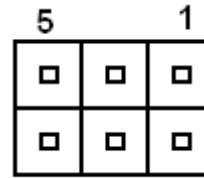
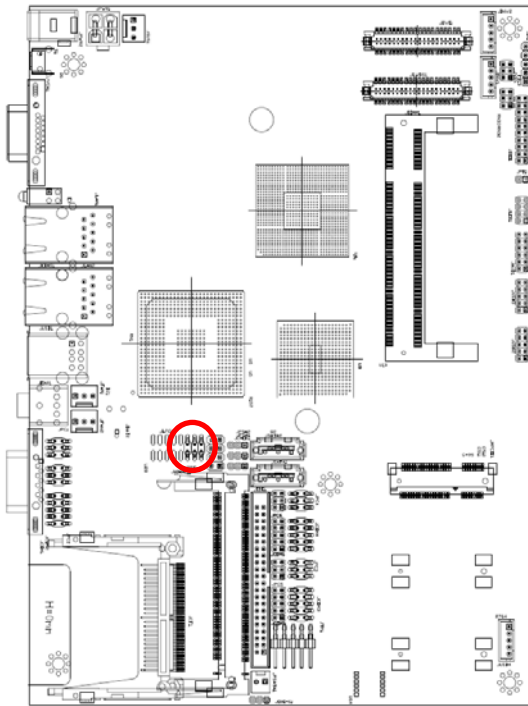

Signal	PIN	PIN	Signal
+5V	1	2	GND
SSPI_CE#	3	4	SSPI_SCK
SSPI_SO	5	6	SSPI_SI

2.4.21 PS/2 keyboard & mouse connector (JKBMS2)

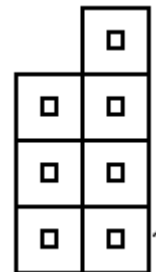
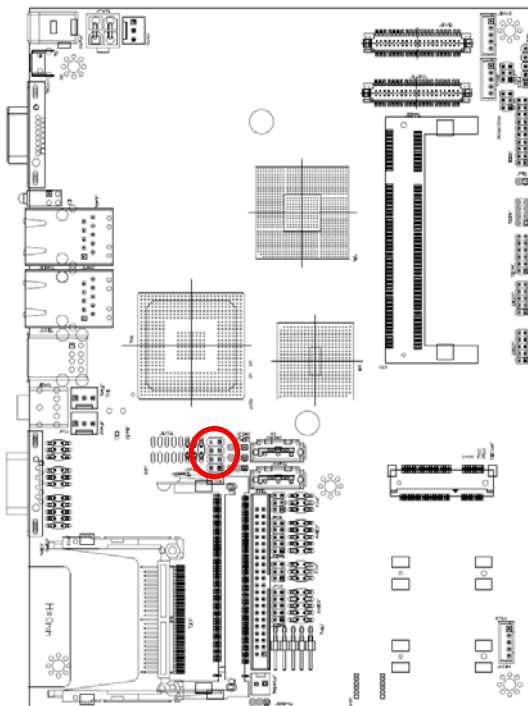

Signal	PIN	PIN	Signal
		7	NC
MS_CK	6	5	MS_DT
+KBVCC	4	3	GND
JB_CK	2	1	KB_DT

2.4.22 SATA1 power input (JPSATA1)

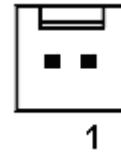
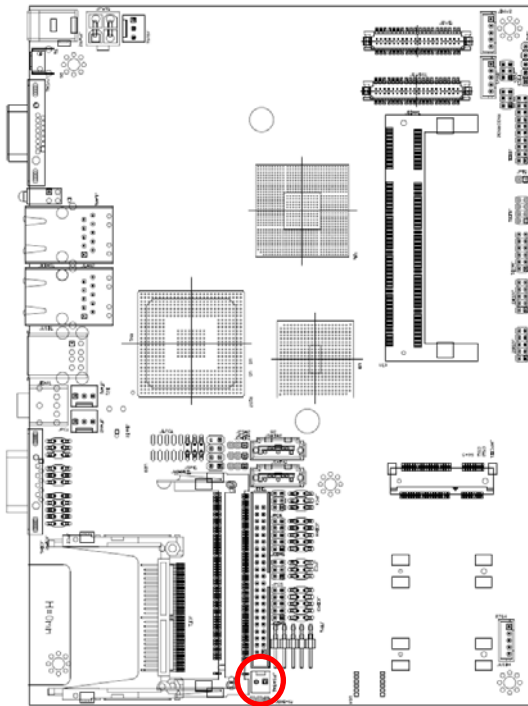

Signal	PIN
GND	1
+5V	2

2.4.23 USB connector (JUSB2/ 3)

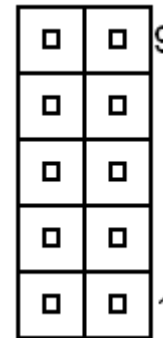
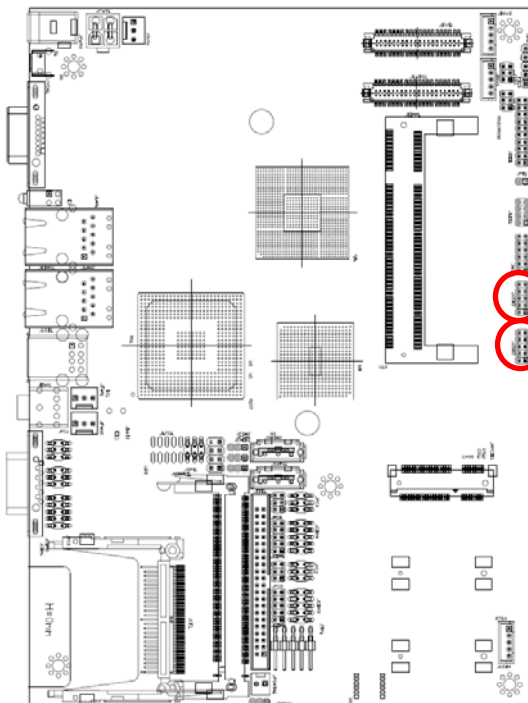

Signal	PIN	PIN	Signal
+5V	10	9	GND
USBD_T2-/ USBD_T4-	8	7	GND
USBD_T2+/ USBD_T4-	6	5	USBD_T3+/ USBD_T5-
GND	4	3	USBD_T3-/ USBD_T5-
GND	2	1	+5V

EBM-945GSE

2.4.24 USB connector (JUSB4)

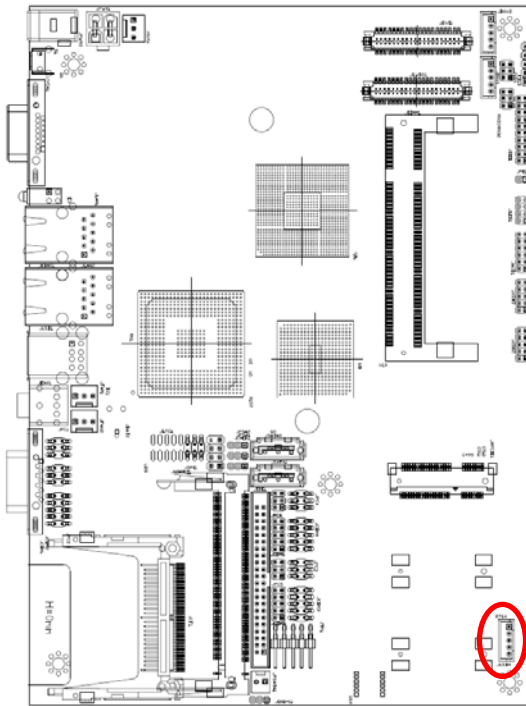

Signal	PIN
+3.3V	1
USBD_T7-	2
USBD_T7+	3
GND	4
GND	5

2.4.25 LED indicator connector (JLED1)

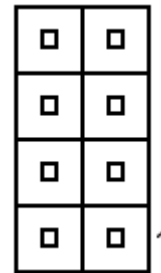
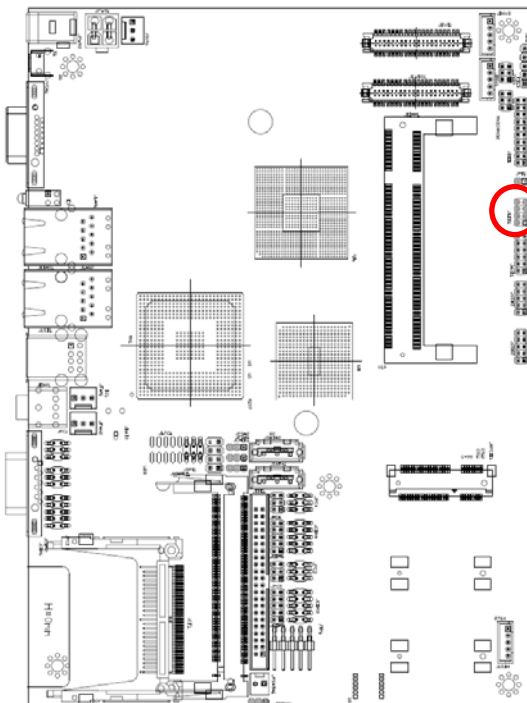

Signal	PIN	PIN	Signal
+3V_DUAL	8	7	LED_LINKACT-2
+3V_DUAL	6	5	LED_LINKACT-1
+3VS	4	3	-HD_LED
+3VS	2	1	GND

2.4.26 24-bit LVDS/DVI Connector (JDVI1, Optional)

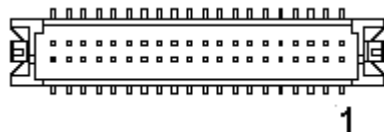
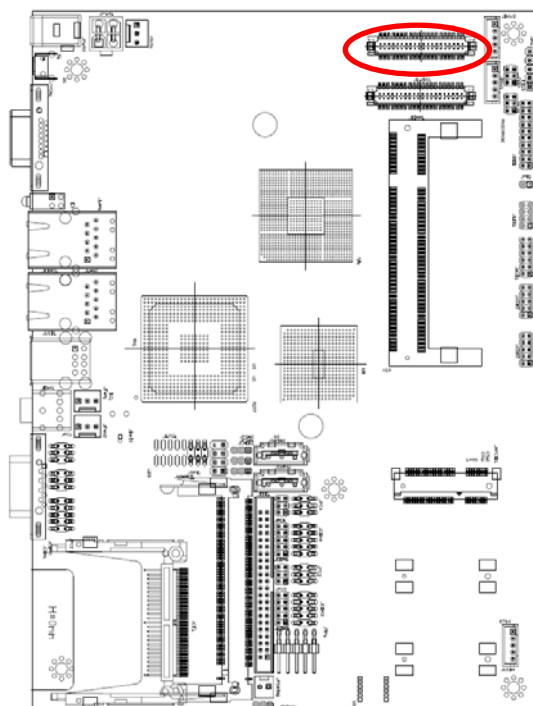

24-bit LVDS

Signal	PIN	PIN	Signal
+5V	2	1	+3.3V
+5V	4	3	+3.3V
I ² C_DAT	6	5	I ² C_CLK
GND	8	7	GND
Txout0	10	9	Txout1
Txout0#	12	11	Txout1#
GND	14	13	GND
Txout2	16	15	Txout3
Txout2#	18	17	Txout3#
GND	20	19	GND
E_Txout0	22	21	E_Txout1
E_Txout0#	24	23	E_Txout1#
GND	26	25	GND
E_Txout2	28	27	E_Txout3
E_Txout2#	30	29	E_Txout3#
GND	32	31	GND
Txclk	34	33	E_Txclk
Txclk#	36	35	E_Txclk#
GND	38	37	GND
+12V(Optional)	40	39	+12V(Optional)

DVI

Signal	PIN	PIN	Signal
+5V	2	1	+3.3V
+5V	4	3	+3.3V
--	6	5	--
GND	8	7	GND
TLC	10	9	TDC0
TLC#	12	11	TDC0#
GND	14	13	GND
TDC1	16	15	--
TDC1#	18	17	--
GND	20	19	GND
--	22	21	--
--	24	23	--
GND	26	25	GND
--	28	27	--
--	30	29	--
GND	32	31	GND
TDC2	34	33	--
TDC2#	36	35	--
GND	38	37	GND
DVI/DAT	40	39	DVI/CLK



NOTE:

Customized VBIOS is necessary for dual LVDS display function; please contact us for advanced information.

EBM-945GSE

2.4.27 18-bit LVDS Connector (JLVDS1)

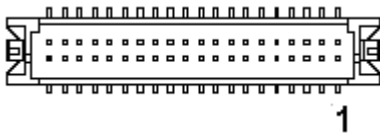
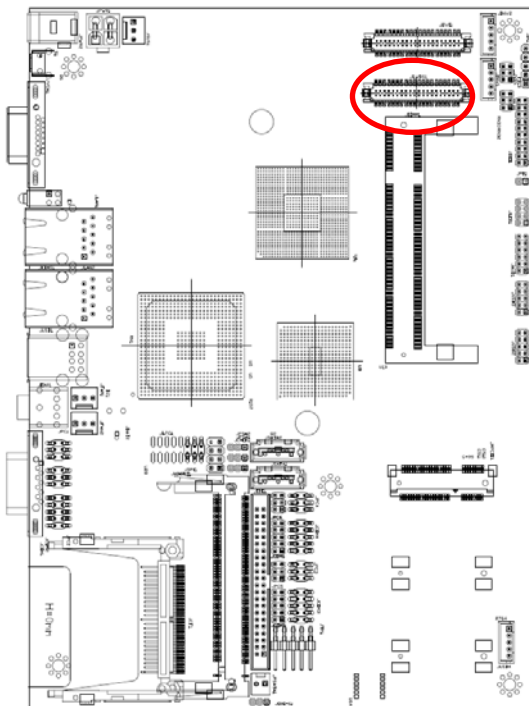

18-bit LVDS

Signal	PIN	PIN	Signal
+5V	2	1	+3.3V
+5V	4	3	+3.3V
NC	6	5	NC
GND	8	7	GND
LA_DATAP0	10	9	LA_DATAP1
LA_DATAN0	12	11	LA_DATAN1
GND	14	13	GND
LA_DATAP2	16	15	NC
LA_DATAN2	18	17	NC
GND	20	19	GND
LB_DATAP0	22	21	LB_DATAP1
LB_DATAN0	24	23	LB_DATAN1
GND	26	25	GND
LB_DATAP2	28	27	NC
LB_DATAN2	30	29	NC
GND	32	31	GND
LA_CLKP	34	33	LB_CLKP
LA_CLKN	36	35	LB_CLKN
GND	38	37	GND
+12V/NC	40	39	+12V/NC

2.4.28 18-bit LVDS Connector (JLVDS2)

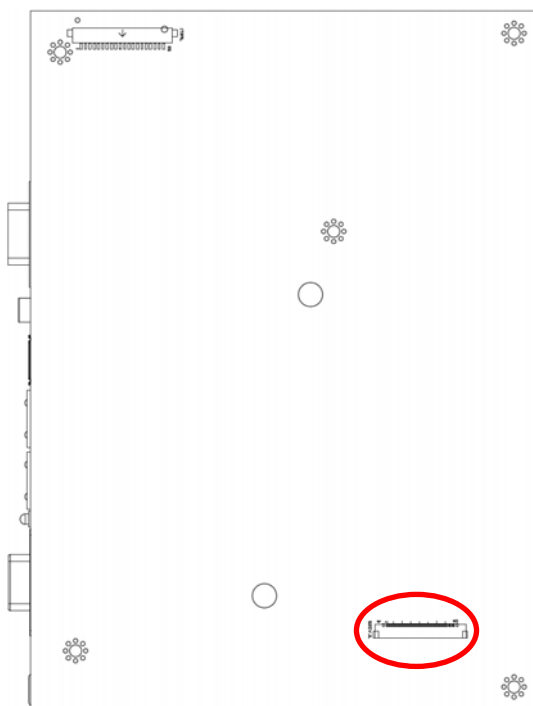

(Rear side)

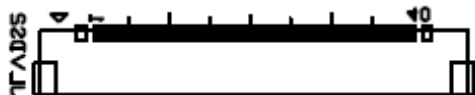

Signal	PIN
NC	1
+3.3V	2
+3.3V	3
+3.3V	4
NC	5
SMB_DATA_S	6
SMB_CLK_S	7
LA_DATAN0	8
LA_DATAP0	9
GND	10
LA_DATAN1	11
LA_DATAP1	12
GND	13
LA_DATAN2	14
LA_DATAP2	15
GND	16
LA_CKLN	17
LA_CLKP	18
GND	19
LB_DATAN0	20

Signal	PIN
LB_DATAP0	21
GND	22
LB_DATAN1	23
LB_DATAP1	24
GND	25
LB_DATAN2	26
LB_DATAP2	27
GND	28
LB_CKLN	29
LB_CLKP	30
GND	31
GND	32
GND	33
NC	34
INV_ON	35
INV_ADJ	36
NC	37
+5V	38
+5V	39
+5V	40



NOTE:

When using JLVDS2, please set up either JINV1 (jumper 4-6) or JLVDS1.

EBM-945GSE

2.4.29 Print port Connector (JPRT1)

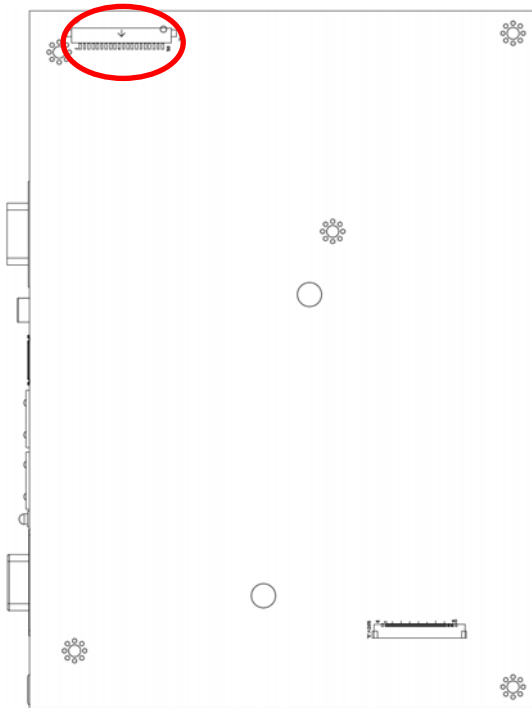

(Rear side)

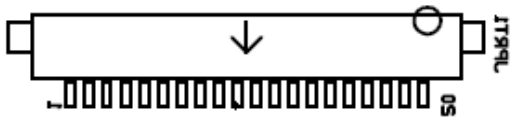

Signal	PIN
P_-STBT	1
P_PRD0T	2
P_PRD1T	3
P_PRD2T	4
P_PRD3T	5
P_PRD4T	6
P_PRD5T	7
P_PRD6T	8
P_PRD7T	9
P_-ACK	10
P_BUSY	11
P_PE	12
P_SLCT	13
P_-AFD	14
P_-ERR	15
P_-INIT	16
P_-SLIN	17
GND	18
GND	19
GND	20



NOTE:

JPRT1 is optional. When using JPRT1, please set up by BIOS.

3. BIOS Setup

3.1 Starting Setup

The AwardBIOS™ is immediately activated when you first power on the computer. The BIOS reads the system information contained in the CMOS and begins the process of checking out the system and configuring it. When it finishes, the BIOS will seek an operating system on one of the disks and then launch and turn control over to the operating system.

While the BIOS is in control, the Setup program can be activated in one of two ways:

By pressing immediately after switching the system on, or

By pressing the key when the following message appears briefly at the bottom of the screen during the POST (Power On Self Test).

Press DEL to enter SETUP

If the message disappears before you respond and you still wish to enter Setup, restart the system to try again by turning it OFF then ON or pressing the "RESET" button on the system case. You may also restart by simultaneously pressing <Ctrl>, <Alt>, and <Delete> keys. If you do not press the keys at the correct time and the system does not boot, an error message will be displayed and you will again be asked to.

Press F1 to Continue, DEL to enter SETUP

3.2 Using Setup

In general, you use the arrow keys to highlight items, press <Enter> to select, use the PageUp and PageDown keys to change entries, press <F1> for help and press <Esc> to quit. The following table provides more detail about how to navigate in the Setup program using the keyboard.

Button	Description
↑	Move to previous item
↓	Move to next item
←	Move to the item in the left hand
→	Move to the item in the right hand
Esc key	Main Menu -- Quit and not save changes into CMOS Status Page Setup Menu and Option Page Setup Menu -- Exit current page and return to Main Menu
PgUp key	Increase the numeric value or make changes
PgDn key	Decrease the numeric value or make changes
+ key	Increase the numeric value or make changes
- key	Decrease the numeric value or make changes
F1 key	General help, only for Status Page Setup Menu and Option Page Setup Menu
(Shift) F2 key	Change color from total 16 colors. F2 to select color forward, (Shift) F2 to select color backward
F3 key	Calendar, only for Status Page Setup Menu
F4 key	Reserved
F5 key	Restore the previous CMOS value from CMOS, only for Option Page Setup Menu
F6 key	Load the default CMOS value from BIOS default table, only for Option Page Setup Menu
F7 key	Load the default
F8 key	Reserved
F9 key	Reserved
F10 key	Save all the CMOS changes, only for Main Menu

- **Navigating Through The Menu Bar**

Use the left and right arrow keys to choose the menu you want to be in.



Note: Some of the navigation keys differ from one screen to another.

EBM-945GSE

- **To Display a Sub Menu**

Use the arrow keys to move the cursor to the sub menu you want. Then press <Enter>. A “>” pointer marks all sub menus.

3.3 Getting Help

Press F1 to pop up a small help window that describes the appropriate keys to use and the possible selections for the highlighted item. To exit the Help Window press <Esc> or the F1 key again.

3.4 In Case of Problems

If, after making and saving system changes with Setup, you discover that your computer no longer is able to boot, the AwardBIOS™ supports an override to the CMOS settings which resets your system to its defaults.

The best advice is to only alter settings which you thoroughly understand. To this end, we strongly recommend that you avoid making any changes to the chipset defaults. These defaults have been carefully chosen by both Award and your systems manufacturer to provide the absolute maximum performance and reliability. Even a seemingly small change to the chipset setup has the potential for causing you to use the override.

3.5 Main Menu

Once you enter the AwardBIOS™ CMOS Setup Utility, the Main Menu will appear on the screen. The Main Menu allows you to select from several setup functions and two exit choices. Use the arrow keys to select among the items and press <Enter> to accept and enter the sub-menu.

Note that a brief description of each highlighted selection appears at the bottom of the screen.

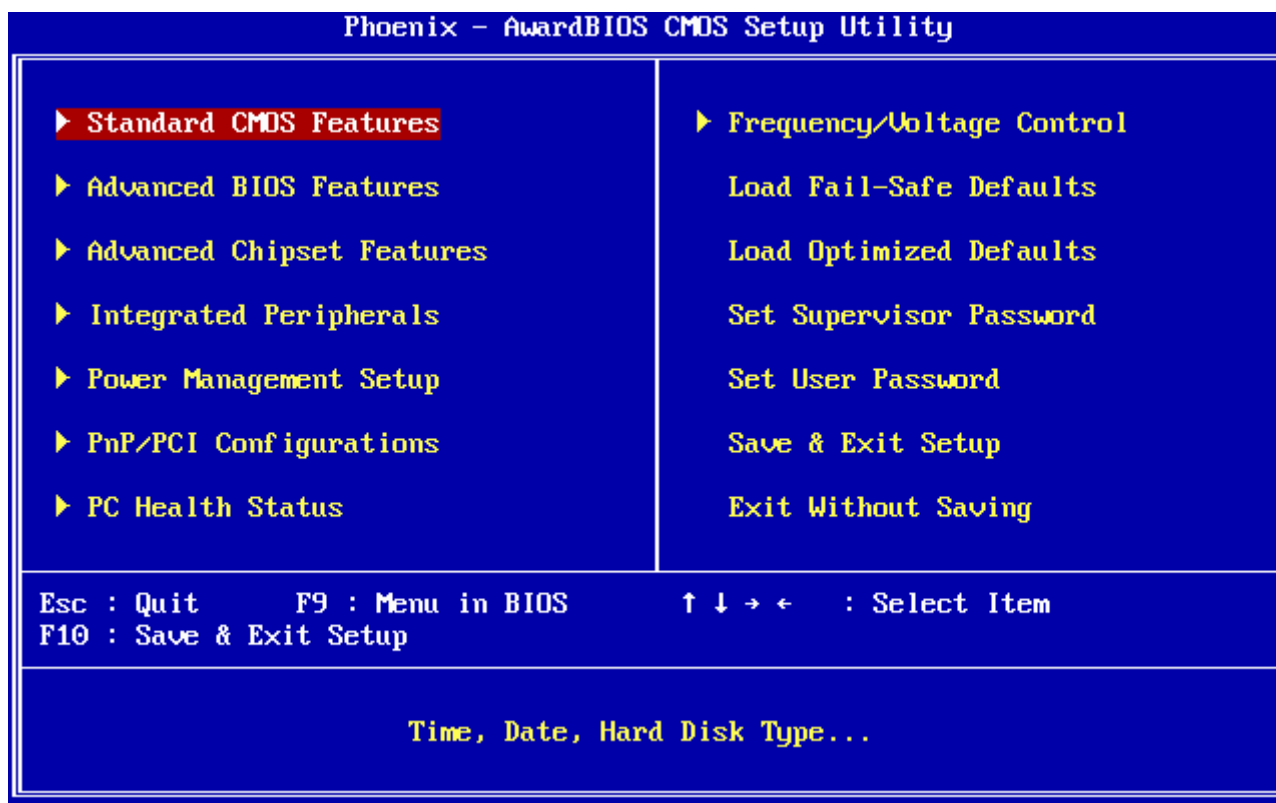

Note: The BIOS setup screens shown in this chapter are for reference purposes only, and may not exactly match what you see on your screen.

Visit the Avalue website (www.avalue.com.tw) to download the latest product and BIOS information.

EBM-945GSE

3.5.1 Standard CMOS Features

The items in Standard CMOS Setup Menu are divided into few categories. Each category includes no, one or more than one setup items. Use the arrow keys to highlight the item and then use the <PgUp> or <PgDn> keys to select the value you want in each item.

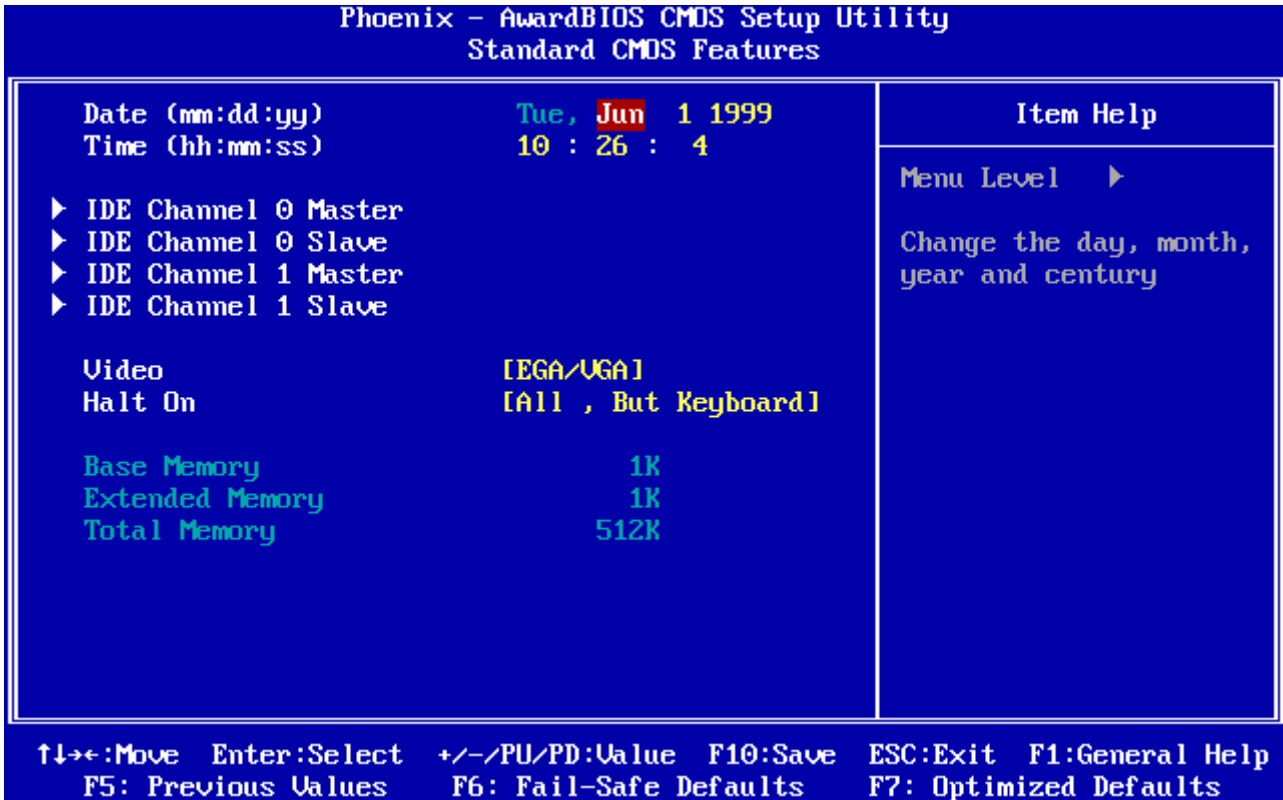

3.5.1.1 Main Menu Selection

This reference table shows the selections that you may make on the Main Menu.

Item	Options	Description
Time	HH : MM : SS	Set the system time
IDE Channel 0 Master IDE Channel 0 Slave IDE Channel 1 Master IDE Channel 1 Slave	Options are in 3.5.1.2	Press <Enter> to enter the sub menu of detailed options
Video	EGA/VGA CGA 40 CGA 80 MONO	Select the default video device
Halt On	All Errors No Errors All, but Keyboard	Select the situation in which you want the BIOS to stop the POST process and notify you

3.5.1.2 IDE Adapter Setup

The IDE adapters control the hard disk drive. Use a separate sub menu to configure each hard disk drive. The below table will shows the IDE primary master sub menu.

Item	Options	Description
IDE HDD Auto-detection	Press Enter	Press Enter to auto-detect the HDD on this channel. If detection is successful, it fills the remaining fields on this menu.
IDE Channel 0 Master IDE Channel 0 Slave IDE Channel 1 Master IDE Channel 1 Slave	None Auto Manual	Selecting 'manual' lets you set the remaining fields on this screen. Selects the type of fixed disk. "User Type" will let you select the number of cylinders, heads, etc. Note: PRECOMP=65535 means NONE !
Access Mode	CHS, LBA Large, Auto	Choose the access mode for this hard disk
The following options are selectable only if the 'IDE Channel ...' item is set to 'Manual'		
Cylinder	Min = 0 Max = 65535	Set the number of cylinders for this hard disk.
Head	Min = 0 Max = 255	Set the number of read/write heads
Precomp	Min = 0 Max = 65535	**** Warning: Setting a value of 65535 means no hard disk
Landing zone	Min = 0 Max = 65535	****
Sector	Min = 0 Max = 255	Number of sectors per track

3.5.2 Advanced BIOS Features

This section allows you to configure your system for basic operation. You have the opportunity to select the system's default speed, boot-up sequence, keyboard operation, shadowing and security.

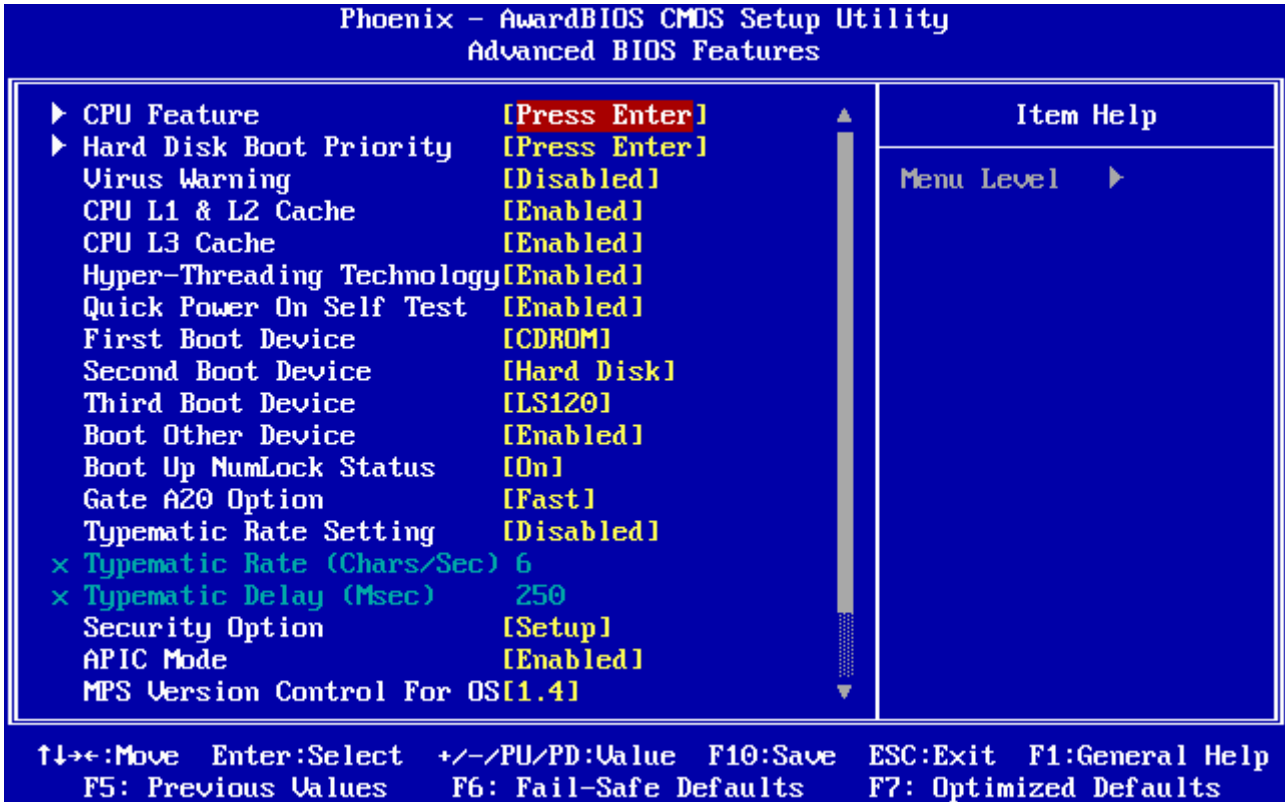

3.5.2.1 CPU Feature

This item allows you to setup the CPU thermal management function.

Item	Options	Description
Delay Prior to Thermal	4, 8, 16, 32 Min	Allow the Thermal Monitor to be activated of certain minutes in automatic mode after the system boots.
Thermal Management	Thermal Monitor 1 Thermal Monitor 2	Allow to choose the thermal management method of the monitor.
TM2 Bus Ratio	0~255	Represents the frequency. Bus ratio of the throttled performance state that will be initiated when the on-die sensor goes from not hot to hot.
TM2 Bus VID	0.700 ~ 1.708	Represents the voltage of the throttled performance state that will be initiated when the on-die sensor goes from not hot to hot.
Limit CPUID MaxVal	Disable Enable	In order to mask the physical CPUID for Proscott core when running WinNT, Award BIOS provides "Limit CPUID MaxVal" feature. Enabling this feature will make the main board BIOS respond "suitable", "virtual" CPUID to OS kernel. So WinNT or the legacy OS can use the masked CPUID to work well with the new CPU design.
C1E Function	Auto, Disabled	The C1E function enables the Core 2

		Extreme to throttle back to its standard clock rate under light load
Execute Disable Bit	Enabled, Disabled	It can help prevent certain classes of malicious buffer overflow attacks when combined with a supporting operating system.
Virtualization Technology	Enabled, Disabled	This BIOS feature is used to enable or disable the Intel Virtualization Technology (IVT) extensions that allow multiple operating systems to run simultaneously on the same system.

3.5.2.2 Hard Disk Boot Priority

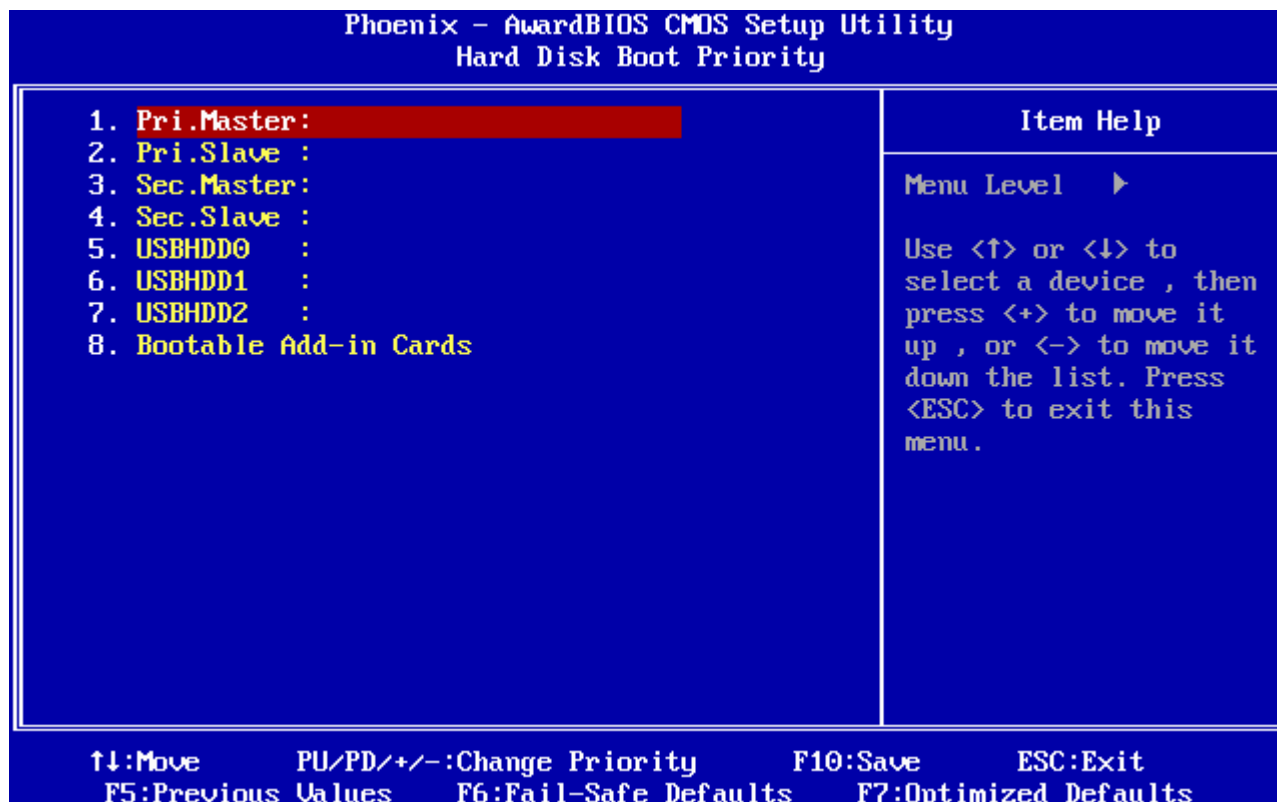

This item allows you to set the boot priority of the hard drives installed in the system.

Item	Description
Pri./Sec. Master/Slave	Boot up from IDE Primary/Secondary Master/Slave Hard Disk
USBHDD 0/1/2	Boot up from 1st/2nd/3rd USB Hard Disk
Bootable Add-in Cards	Boot up from other Add-In Card Hard Disk Device.

3.5.2.3 Virus Warning

Allows you to choose the VIRUS Warning feature for IDE Hard Disk boot sector protection. If this function is enabled and someone attempt to write data into this area, BIOS will show a warning message on screen and alarm beep.

Item	Description
Enabled	Activates automatically when the system boots up causing a warning message to appear when anything attempts to access the boot sector or hard disk partition table.
Disabled	No warning message will appear when anything attempts to access the boot sector or hard disk partition table.

EBM-945GSE

3.5.2.4 CPU L1 & L2 & L3 Cache

The item allows you to speed up memory access. However, it depends on CPU design.

Item	Description
Enabled	Enable cache
Disabled	Disable cache

3.5.2.5 Hyper-Threading Technology

The item allows you to enable HT Technology. However, it depends on CPU design.

Item	Description
Enabled	Enable cache
Disabled	Disable cache

3.5.2.6 Quick Power On Self Test

This category speeds up Power On Self Test (POST) after you power up the computer. If it is set to Enable, BIOS will shorten or skip some check items during POST.

Item	Description
Enabled	Enable quick POST
Disabled	Normal POST

3.5.2.7 First/Second/Third/Other Boot Device

The BIOS attempts to load the operating system from the devices in the sequence selected in these items.

Item	Description
LS120	LS120 Device
Hard Disk	Hard Disk Device
CDROM	CDROM Device
ZIP100	ZIP-100 Device
USB-FDD	USB Floppy Device
USB-ZIP	USB ZIP Device
USB-CDROM	USB CDROM Device
LAN	Network Device
Disabled	Disabled any boot device

3.5.2.8 Boot Up NumLock Status

Select power on state for NumLock.

Item	Description
On	Enable NumLock
Off	Disable NumLock

3.5.2.9 Gate A20 Option

Select if chipset or keyboard controller should control Gate A20.

Item	Description
Normal	A pin in the keyboard controller controls Gate A20
Fast	Lets chipset control Gate A20

3.5.2.10 Typematic Rate Setting

This feature enables you to control the keystroke repeat rate when you depress a key continuously. When enabled, you can manually adjust the settings using the two typematic controls (Typematic Rate and Typematic Delay). If disabled, the BIOS will use the default setting.

Item	Description
Enabled	Enable typematic rate/delay setting
Disabled	Disable typematic rate/delay setting

3.5.2.11 Typematic Rate (Chars/Sec)

This is the rate at which the keyboard will repeat the keystroke if you press it continuously. This setting will only work if Typematic Rate Setting is enabled..

Options: 6, 8, 10, 12, 15, 20, 24, 30

3.5.2.12 Typematic Delay (Msec)

This is the delay, in milliseconds, before the keyboard automatically repeats the keystroke that you have pressed continuously. This setting will only work if Typematic Rate Setting is enabled.

Options: 250, 500, 750, 1000

3.5.2.13 Security Option

Select whether the password is required every time the system boots or only when you enter setup.

Item	Description
System	The system will not boot and access to Setup will be denied if the correct password is not entered at the prompt.
Setup	The system will boot, but access to Setup will be denied if the correct password is not entered at the prompt.



Note: To disable security, select PASSWORD SETTING at Main Menu and then you will be asked to enter password. Do not type anything and just press <Enter>, it will disable security. Once the security is disabled, the system will boot and you can enter Setup freely.

3.5.2.14 APIC Mode

The BIOS supports versions 1.4 of the Intel multiprocessor specification. When enabled, The MPS Version 1.4 Control for OS can be activated.

The choice: Enabled/Disabled.

3.5.2.15 MPS Version Control For OS

This feature is only applicable to multiprocessor board as it specifies the version of the Multi-Processor Specification (MPS) that the board will use.

The choice: 1.4, 1.1.

3.5.2.16 OS Select for DRAM > 64MB

Select the operating system that is running with greater than 64MB of RAM on the system.

Item	Description
Non-OS2	Disable OS for over 64 MB DRAM
OS2	Enable OS for over 64 MB DRAM

3.5.2.17 Report No FDD For WIN95

The original Windows95 requires the presence of a floppy. Unless the BIOS tells it to disregard the absence of the drive, it will generate an error message. For other operating systems as Win98 etc this field is without relevance.

Item	Description
No	Don't generate error message
Yes	Generate error message

EBM-945GSE

3.5.2.18 Small Logo (EPA) Show

This item allows you enabled/disabled the small EPA logo show on screen at the POST step.

Item	Description
Enabled	EPA Logo show is enabled
Disabled	EPA Logo show is disabled

3.5.3 Advanced Chipset Features

This section allows you to configure the system based on the specific features of the installed chipset. This chipset manages bus speeds and access to system memory resources, such as DRAM and the external cache. It also coordinates communications between the conventional ISA bus and the PCI bus. It must be stated that these items should never need to be altered. The default settings have been chosen because they provide the best operating conditions for your system. The only time you might consider making any changes would be if you discovered that data was being lost while using your system.

The first chipset settings deal with CPU access to dynamic random access memory (DRAM). The default timings have been carefully chosen and should only be altered if data is being lost. Such a scenario might well occur if your system had mixed speed DRAM chips installed so that greater delays may be required to preserve the integrity of the data held in the slower memory chips.

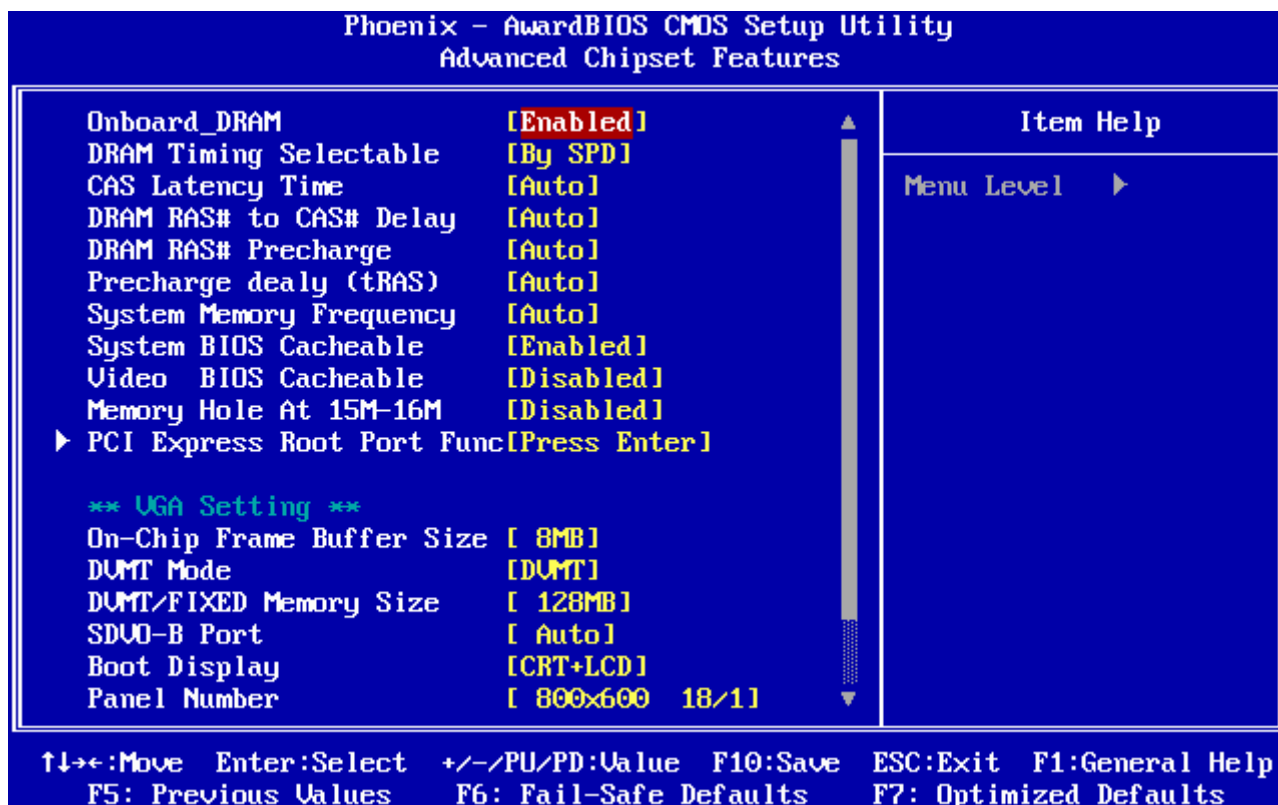

3.5.3.1 Onboard – DRAM

This item allows you to select the onboard – DRAM by yourself.

The choices: Enabled, Disabled.

3.5.3.2 DRAM Timing Selectable

This item allows you to select the DRAM timing value by SPD data or Manual by yourself.

The choices: Manual, By SPD.

3.5.3.3 CAS Latency Time

This item controls the time delay (in clock cycles - CLKs) that passes before the SDRAM

EBM-945GSE

starts to carry out a read command after receiving it. This also determines the number of CLKs for the completion of the first part of a burst transfer. In other words, the lower the latency, the faster the transaction.

The choices: 5, 4, 3, 6, Auto.

3.5.3.4 DRAM RAS# to CAS# Delay

This option allows you to insert a delay between the RAS (**Row Address Strobe**) and CAS (**Column Address Strobe**) signals. This delay occurs when the SDRAM is written to, read from or refreshed. Naturally, reducing the delay improves the performance of the SDRAM while increasing it reduces performance.

The choices: 2, 3, 4, 5, 6, Auto.

3.5.3.5 DRAM RAS# Precharge

This option sets the number of cycles required for the RAS to accumulate its charge before the SDRAM refreshes. Reducing the precharge time to **2** improves SDRAM performance but if the precharge time of **2** is insufficient for the installed SDRAM, the SDRAM may not be refreshed properly and it may fail to retain data

So, for better SDRAM performance, set the **SDRAM RAS Precharge Time** to **2** but increase it to **3** if you face system stability issues after reducing the precharge time.

The choices: 2, 3, 4, 5, 6, Auto.

3.5.3.6 Precharge Delay (tRAS)

It allows controlling the memory bank's minimum row active time (tRAS). This constitutes the time when a row is activated until the time the same row can be deactivated. If the tRAS period is too long, it can reduce performance by unnecessarily delaying the deactivation of active rows. Reducing the tRAS period allows the active row to be deactivated earlier.

If the tRAS period is too short, there may not be enough time to complete a burst transfer.

This reduces performance and data may be lost or corrupted.

The choices: Auto, 4, 5, 6, 7, 8, 9, 10, 11, 12, 13, 14, 15.

3.5.3.7 System Memory Frequency

It allows controlling the system memory frequency. The memory frequency will either be equal to or less than the processor system bus frequency.

The choices: Auto, 400MHz, 533MHz.

3.5.3.8 System BIOS Cacheable

This feature is only valid when the system BIOS is shadowed. It enables or disables the caching of the system BIOS ROM at **F0000h-FFFFFh** via the L2 cache. This greatly speeds up accesses to the system BIOS. However, this does **not** translate into better system performance because the OS does not need to access the system BIOS much.

The choices: Disabled, Enabled.

3.5.3.9 Video BIOS Cacheable

This feature is only valid when the video BIOS is shadowed. It enables or disables the caching of the video BIOS ROM at **C0000h-C7FFFh** via the L2 cache. This greatly speeds up accesses to the video BIOS. However, this does **not** translate into better system

performance because the OS bypasses the BIOS using the graphics driver to access the video card's hardware directly.

The Choice: Enabled, Disabled.

3.5.3.10 Memory Hole At 15M-16M

Enabling this feature reserves 15MB to 16MB memory address space to ISA expansion cards that specifically require this setting. This makes the memory from 15MB and up unavailable to the system. Expansion cards can only access memory up to 16MB.

The choice: Enable, Disable.

3.5.3.11 PCI Express Root

For the PCI Express root ports, the assignment of a function number to a root port is not fixed. This item allows you to re-assign the function numbers on a port by port basis. You can disable/hide any root port and have still have functions 0 thru N-1 where N is the total number of enabled root ports.

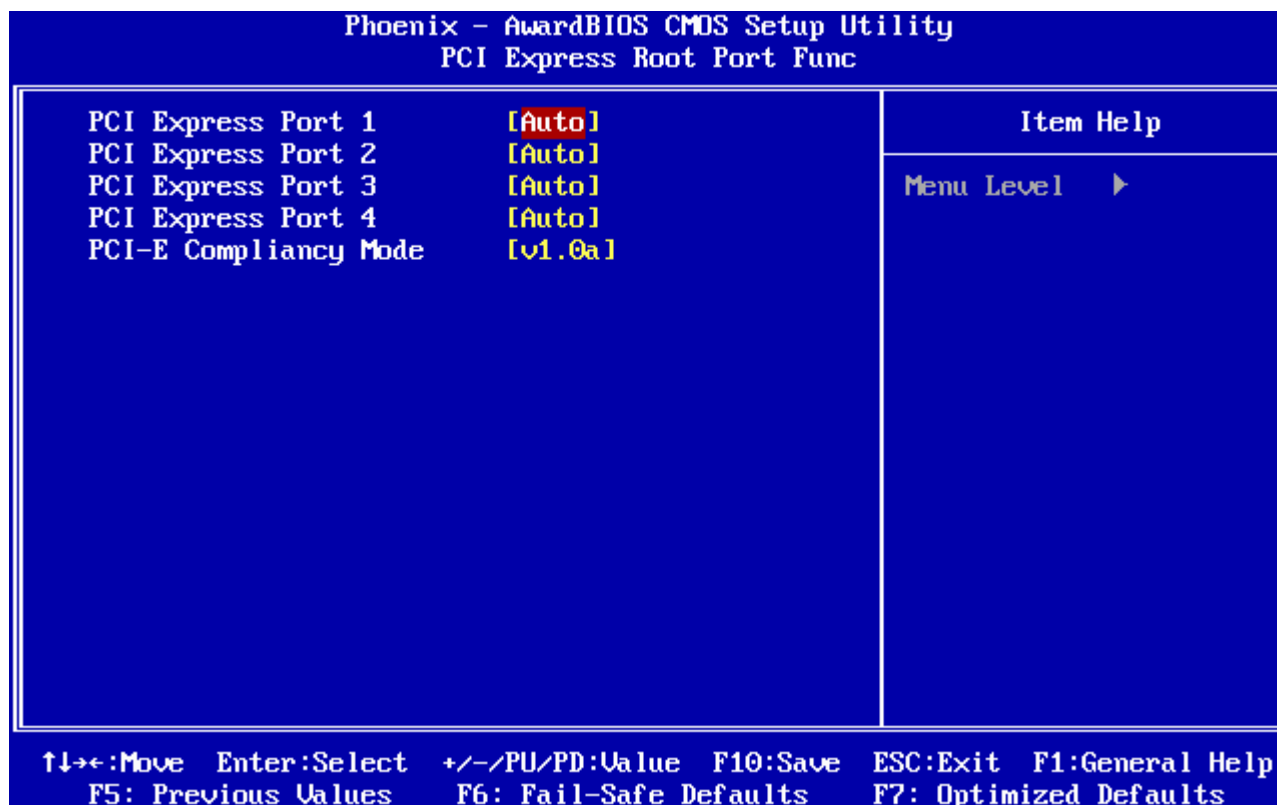

The choices: Auto, Enabled, Disabled.

3.5.3.11.1 PCI-E Compliancy Mode

This feature is used to select the compliancy mode for PCI-E.

The choices: v.1.0a, v1.0

EBM-945GSE

3.5.3.12 VGA Setting

Item	Options	Description				
On-Chip Frame Buffer Size	1MB 4MB 8MB 16MB 32MB	This item is to select the amount of system memory that will be utilized as internal graphics device memory.				
DVMT Mode	FIXED DVMT BOTH	This feature allows you to select the Dynamic Video Memory Technology (DVMT) operating mode.				
DVMT/FIXED Memory Size	64MB 128MB 224MB	This feature allows you to select the memory size of DVMT/BOTH operating mode.				
SDVO-B Port	AUTO DVI(7307) LVDS(7308)					
Boot Display	Auto CRT, LCD, CRT+LCD, DVI, TV, CRT+DVI, LCD(24bit) CRT+LCD(24bit), CRT+TV	This feature allows you to select the display device when you boot up the system.				
Panel Number	<table border="1"> <tr> <td>18 BIT</td> <td>640x480 1x18B, 800x600 1x18B, 1024x768 1x18B, 1280x1024 2x18B, 1400x1050 2x18B, 1440x900 2x18B, 1600x1200 2x18B, 1280x768 1x18B, 1680x1050 2x18B, 1920x1080 2x18B, 1024x768 1x18B, 1366x768 1x18B, 800x480 1x18B, 1280x800 1x18B, 1280x600 1x18B, 2048x1536 2x18B.</td> </tr> <tr> <td>24 BIT</td> <td>1024x768 2x24B 1280x1024 2x24B 1680x1050 2x24B</td> </tr> </table>	18 BIT	640x480 1x18B, 800x600 1x18B, 1024x768 1x18B, 1280x1024 2x18B, 1400x1050 2x18B, 1440x900 2x18B, 1600x1200 2x18B, 1280x768 1x18B, 1680x1050 2x18B, 1920x1080 2x18B, 1024x768 1x18B, 1366x768 1x18B, 800x480 1x18B, 1280x800 1x18B, 1280x600 1x18B, 2048x1536 2x18B.	24 BIT	1024x768 2x24B 1280x1024 2x24B 1680x1050 2x24B	This feature allows you to select Panel Resolution that will be displayed depending on the LCD Panel.
18 BIT	640x480 1x18B, 800x600 1x18B, 1024x768 1x18B, 1280x1024 2x18B, 1400x1050 2x18B, 1440x900 2x18B, 1600x1200 2x18B, 1280x768 1x18B, 1680x1050 2x18B, 1920x1080 2x18B, 1024x768 1x18B, 1366x768 1x18B, 800x480 1x18B, 1280x800 1x18B, 1280x600 1x18B, 2048x1536 2x18B.					
24 BIT	1024x768 2x24B 1280x1024 2x24B 1680x1050 2x24B					
TV Standard	Off, NTSC, PAL, SECAM	This feature allows you to select an analog TV standard system.				
Video Connector	Automatic, Composite, Component, Both.	This feature allows you to select the output video connector style.				
TV Format	Auto, NTSC_M, NTSC_M_J, NTSC_433, NTSC_N, PAL_B, PAL_G,	This feature allows you to select the TV format.				

	PAL_D, PAL_H, PAL_I, PAL_M, PAL_N, PAL_60, SECAM_L, SECAM_L1, SECAM_B, SECAM_D, SECAM_G, SECAM_H	
LVDS Back Light	100%,96%,93%,90%, 87%,84%,81%,77%, 72%,68%,65%,62%, 59%,56%,53%,50%, 46%,43%,40%	This feature allows you to control the back light.

EBM-945GSE

3.5.4 Integrated Peripherals

Use this menu to specify your settings for integrated peripherals.

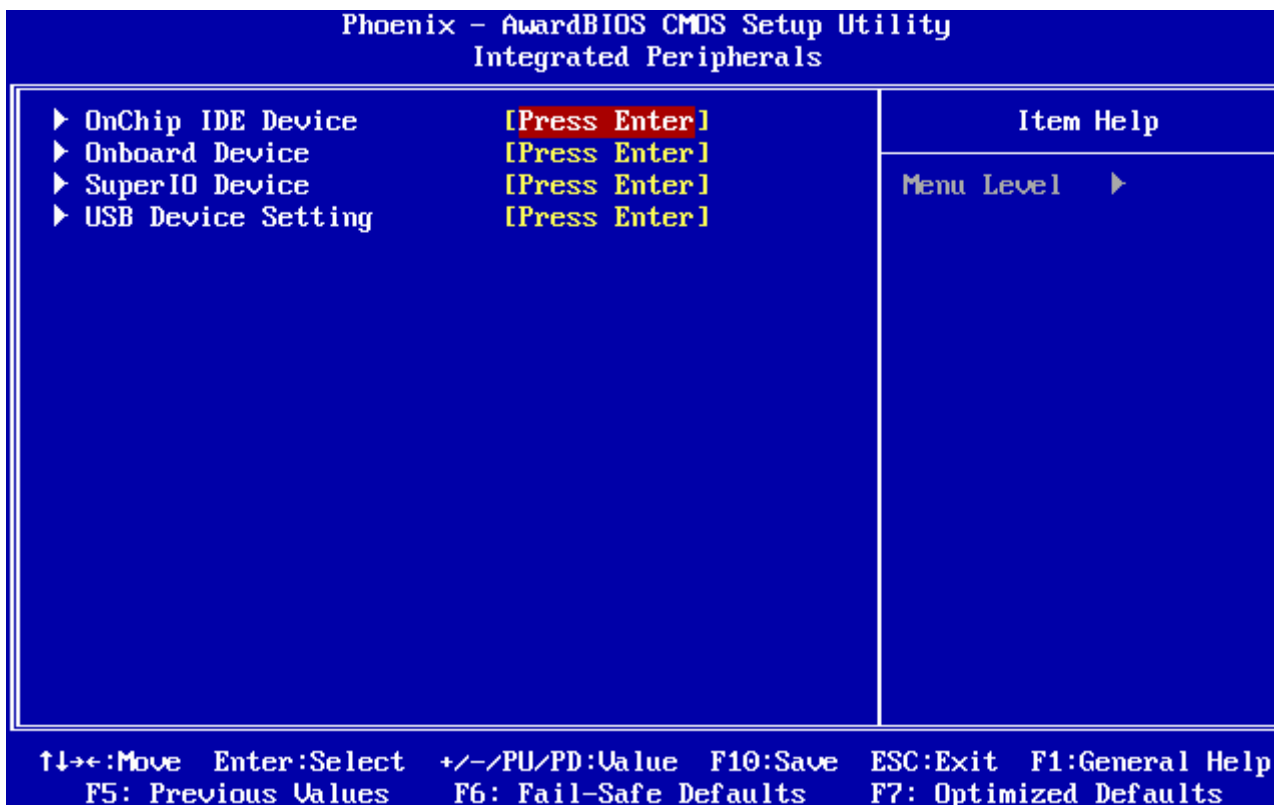

3.5.4.1 OnChip IDE Device

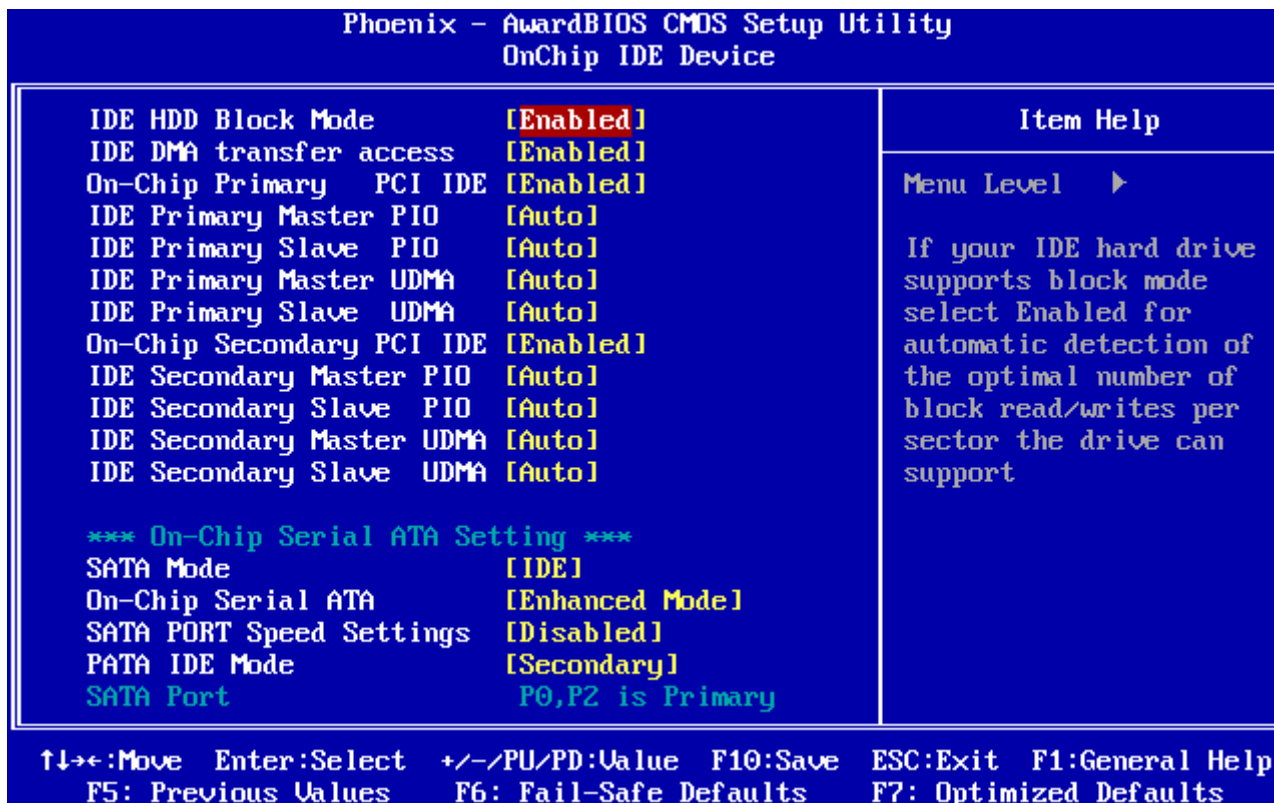

The chipset contains a PCI IDE interface with support for one IDE channel and two SATA channels. Select Enabled to activate the primary IDE interface. Select Disabled to

deactivate this interface.

Item	Options	Description
IDE HDD Block Mode	Enabled Disabled	Speeds up HDD access by transferring data from multiple sectors at once instead of using the old single sector transfer mode if the HDD supports block transfers and configure the proper block transfer settings for it. Up to 64KB of data can be transferred per interrupt with IDE HDD Block Mode enabled. (Virtually all HDDs now support block transfers.)
IDE DMA transfer access	Enabled Disabled	It allows you to enable or disable DMA (Direct Memory Access) support for all IDE devices. If you disable this BIOS feature, the BIOS will disable DMA transfers for all IDE drives. They will revert to PIO mode transfers. If you enable this BIOS feature, the BIOS will enable DMA transfers for all IDE drives. The proper DMA mode will be detected at boot-up. If the drive does not support DMA transfers, then it will use PIO mode instead.
On-Chip Primary/Secondary PCI IDE	Enabled Disabled	The integrated peripheral controller contains an IDE interface with support for two IDE channels. It allows you to activate each channel separately.
IDE Primary Master PIO IDE Primary Slave PIO IDE Secondary Master PIO IDE Secondary Slave PIO	Auto Mode 0 Mode 1 Mode 2 Mode 3 Mode 4	The IDE PIO (Programmed Input/Output) fields let you set a PIO mode (0-4) for each of the four IDE devices that the onboard IDE interface supports. Modes 0 through 4 provide successively increased performance. In Auto mode, the system automatically determines the best mode for each device.
IDE Primary Master UDMA IDE Primary Slave UDMA IDE Secondary Master UDMA IDE Secondary Slave UDMA	Auto Disabled	Ultra DMA implementation is possible only if your IDE hard drive supports it and the operating environment includes a DMA driver (Windows 95 OSR2 or a third-party IDE bus master driver). If the hard drive and the system software both support Ultra DMA, select Auto to enable BIOS support.

3.5.4.1.1 On-Chip Serial ATA Setting

The field under the SATA setting includes SATA Mode (IDE), On-Chip Serial ATA (Auto), PATA IDE Mode (Secondary) and SATA Port (P0, P2 is Primary).

Item	Options	Description
SATA Mode	IDE RAID AHCI	It allows you to select the operation mode for SATA controller.
On-Chip Serial ATA	Disabled, Auto, Combined Mode, Enhanced Mode, SATA Only	It provides access to set the mode of the On-Chip SATA devices.
SATA PORT Speed Settings	Disabled Force GEN I Force GEN II	This item allows you to select the speed of SATA ports.
PATA IDE Mode	Primary Secondary	This item shows the PATA IDE mode.

3.5.4.2 Onboard Device

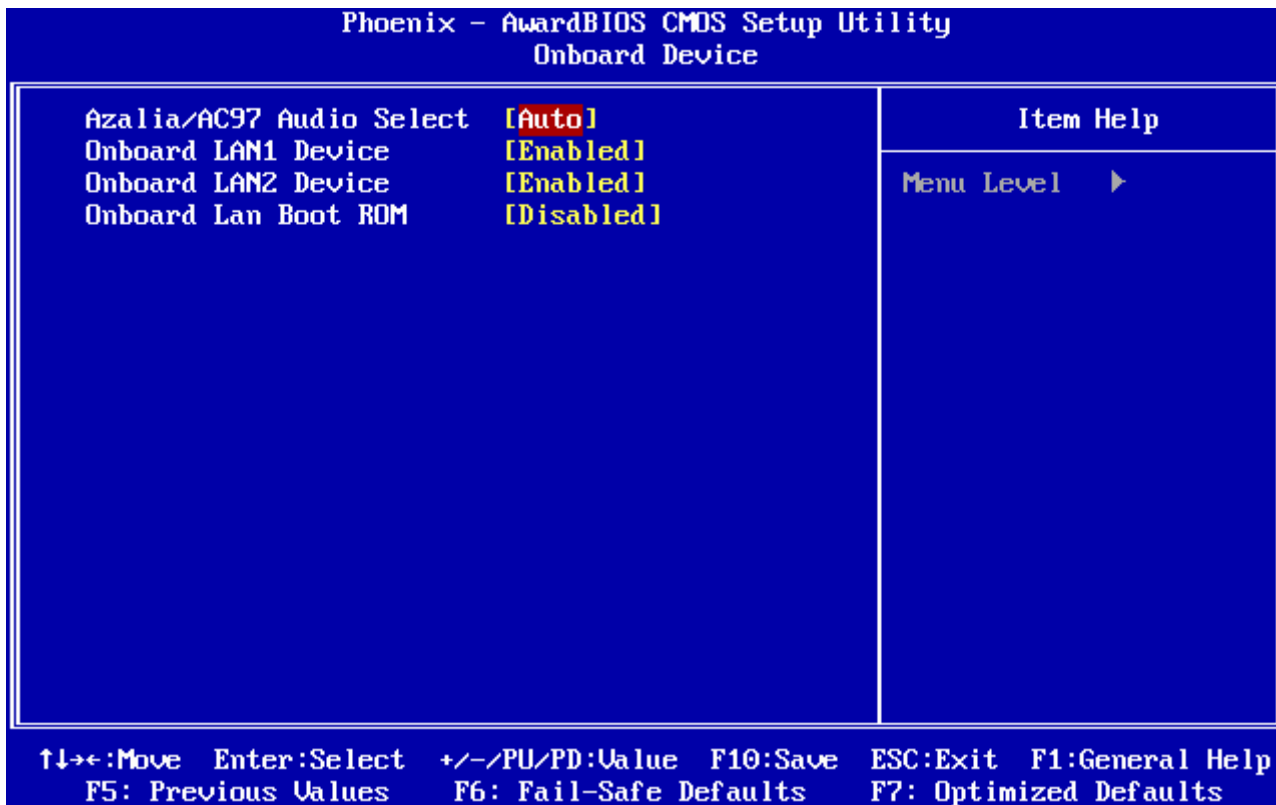

Item	Options	Description
Azalia/AC97 Audio Select	Auto Azalia AC97 Audio and Modem AC97 Modem only All Disabled	This item allows you to select the Audio codec.
Onboard LAN1 Device	Enabled Disabled	This item allows you to enabled the PCIe Lan1 Device.
Onboard LAN2 Device	Enabled Disabled	This item allows you to enabled the PCIe Lan2 Device
Onboard Lan Boot ROM	Enabled Disabled	This item allows you to enabled the LAN Boot ROM.

3.5.4.3 Super IO Device

Phoenix - AwardBIOS CMOS Setup Utility
SuperIO Device

Onboard Serial Port 1 [3F8/IRQ4] COM1 232/422/485 [RS232] Onboard Serial Port 2 [2F8/IRQ3] COM2 232/422/485 [RS232] PWRON After PWR-Fail [Off] Watch Dog Timer Select [Disabled] Onboard Serial Port 3 [3E8] Serial Port 3 Use IRQ [IRQ5] Onboard Serial Port 4 [2E8] Serial Port 4 Use IRQ [IRQ10] Onboard Serial Port 5 [218] Serial Port 5 Use IRQ [IRQ5] Onboard Serial Port 6 [208] Serial Port 6 Use IRQ [IRQ10] Serial Port 3 Mode [Normal]	Item Help <hr/> Menu Level ▶
---	-----------------------------------

↑↓←→:Move Enter:Select +/-/PU/PD:Ualue F10:Save ESC:Exit F1:General Help
 F5: Previous Values F6: Fail-Safe Defaults F7: Optimized Defaults

Item	Options	Description
Onboard Serial Port 1 Onboard Serial Port 2	Disabled, 3F8/IRQ4 2F8/IRQ3, 3E8/IRQ4 2E8/IRQ3, Auto	Select an address and corresponding interrupt for the first and second serial ports.
COM1 232/422/485 COM2 232/422/485	RS232 RS422 RS485	It allows you to select the COM Port mode
Onboard Parallel Port	Disabled, 378/IRQ7 278/IRQ5, 3BC/IRQ7	Select a matching address and interrupt for the physical parallel (printer) port.

3.5.4.4 PWRON After PWR-Fail

This option will determine PWRON after PWR-Fail.

The choices: Off, On, Former-Sts

3.5.4.5 Watch Dog Timer

This option will determine watch dog timer.

The choices: Disabled, 30,40,50,60 Sec, 2, 10, 30 Min.

3.5.4.6 USB Device Setting

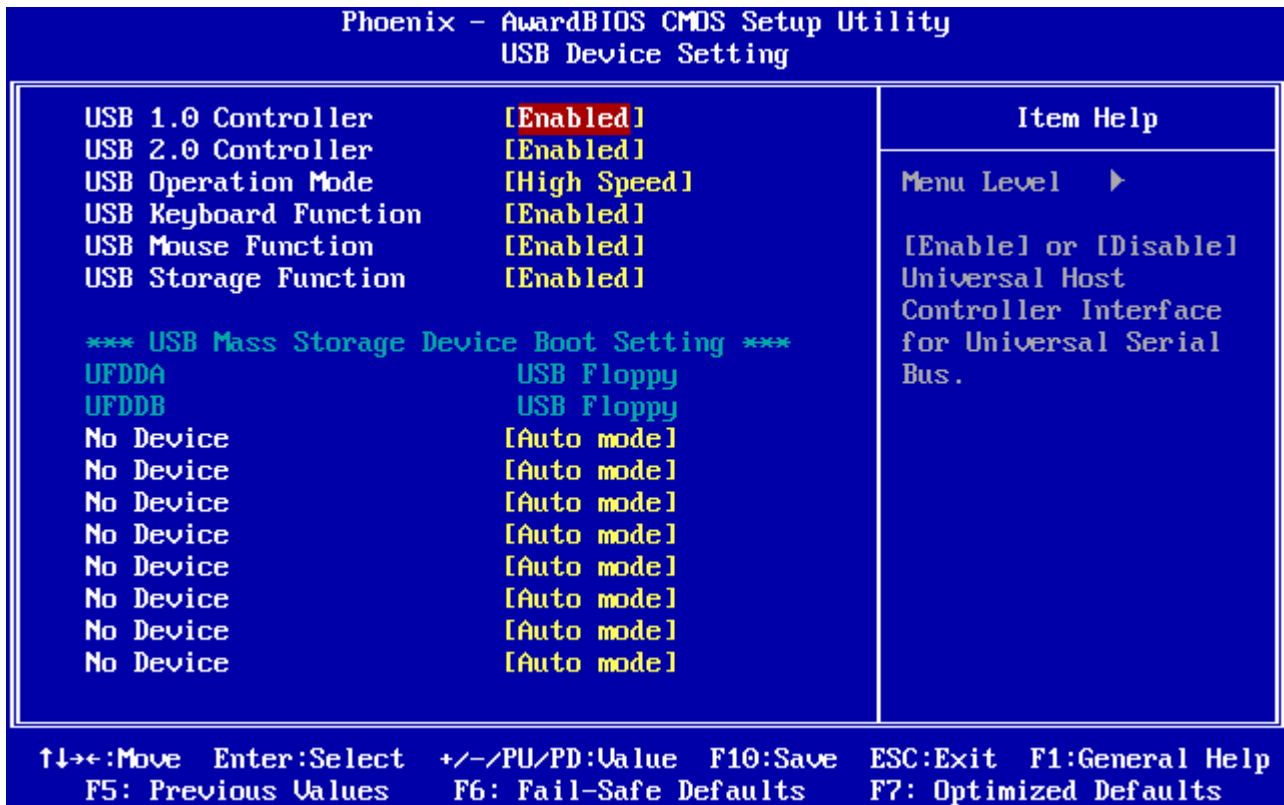

Item	Options	Description
USB 1.0 Controller	Disabled Enabled	This item enables you to use the onboard USB 1.0 controller to communicate with your USB devices
USB 2.0 Controller	Disabled Enabled	This item enables you to use the onboard USB 2.0 controller to communicate with your USB devices
USB Operation Mode	Full/Low Speed High Speed	This item allows you to select the USB mode.
USB Keyboard Function	Disabled Enabled	This BIOS feature determines if support for the USB keyboard should be provided by the operating system or the BIOS.
USB Mouse Function	Disabled Enabled	This BIOS feature determines if support for the USB mouse should be provided by the operating system or the BIOS.
USB Storage Function	Disabled Enabled	This BIOS feature determines if support for the USB Storage should be provided by the operating system or the BIOS.

3.5.5 Power Management Setup

The Power Management Setup allows you to configure you system to most effectively save energy while operating in a manner consistent with your own style of computer use.

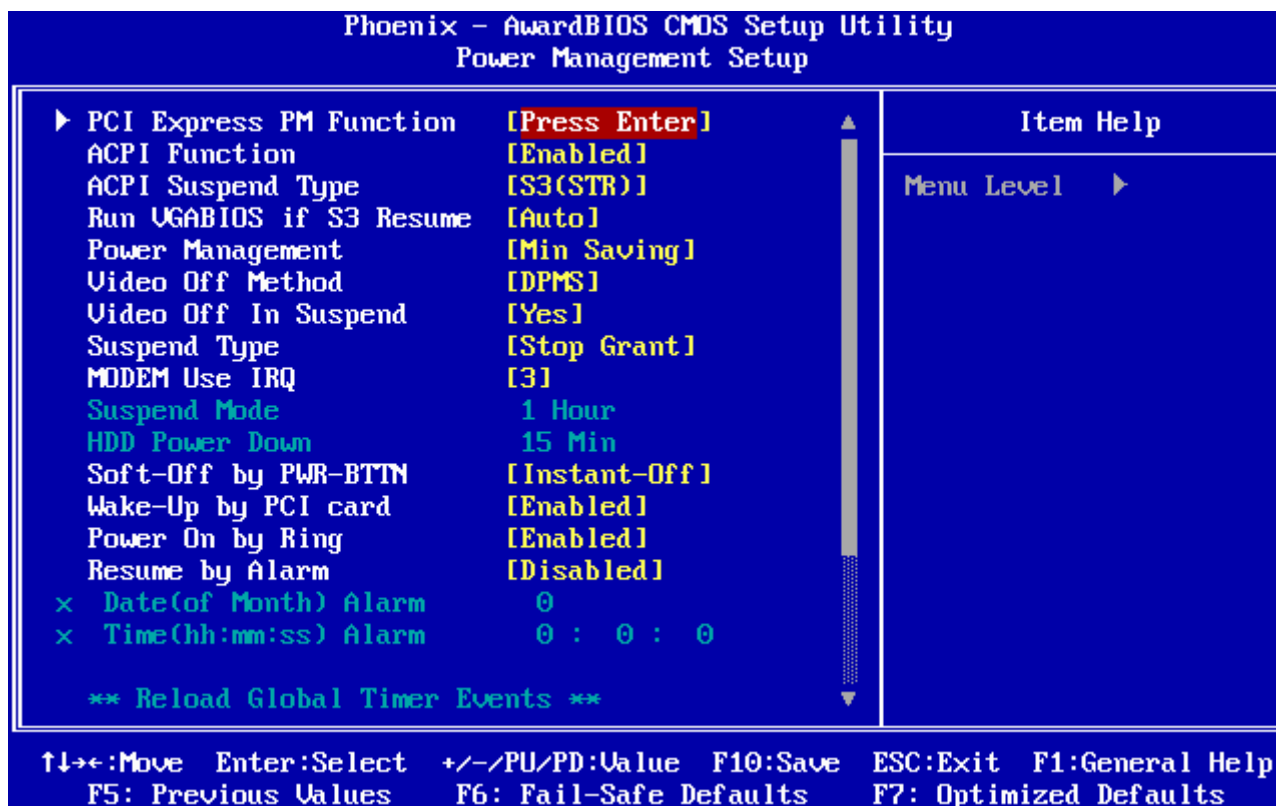

3.5.5.1 PCI Express PM Function

This item allows you to enable/disable the PCI Express PME Function.

The choices: Enabled, Disabled.

3.5.5.2 ACPI Function

This item allows you to enable/disable the ACPI function.

The choices: Enabled, Disabled.

3.5.5.3 ACPI Suspend Type

This item will set which ACPI suspend type will be used.

The choices: S1(POS), S3(STR).S1&S3.

3.5.5.4 Run VGABIOS if S3 Resume

There are 3 modes for you to decide to operate VGABIOS or not when the ACPI suspend type is S3.

The choices: Auto, Yes, No.

3.5.5.5 Power Management

This category allows you to select the type (or degree) of power saving and is directly related to the following modes:

Item	Description
User Defined	Allows you to set each mode individually. When not disabled, each of the ranges are from 1 min. to 1 hr. except for HDD Power Down which ranges from 1 min. to 15 min. and disable.

EBM-945GSE

Min. Saving	Minimum power management, HDD Power Down = 15 Min,
Max. Saving	Maximum power management, HDD Power Down =1 Min,
Disabled	Power management is disabled.

3.5.5.6 Video Off Method

This determines the manner in which the monitor is blanked.

The choices: Blank Screen, V/H SYNC+Blank, DPMS.

3.5.5.7 Video Off In Suspend

This determines the manner in which the monitor is blanked.

The choice: No, Yes.

3.5.5.8 Suspend Type

This function allows to select Suspend type.

The choices: Stop Grant, PwrOn Suspend.

3.5.5.9 MODEM Use IRQ

This determines the IRQ in which the MODEM can use.

The choices: NA, 3, 4, 5, 7, 9, 10, 11.

3.5.5.10 Suspended Mode

It specifies the length of time of system inactivity while in full power on state before the computer enters suspend mode and motivates the enable 'Wake Up Events In Doze & Standby' / 'PM Events'.

The choices: Disabled, 1, 2, 4, 8, 12, 20, 30, 40 mins, 1 hr.

3.5.5.11 HDD Power Down

When enable and after the set time of system inactivity, the hard disk drive will be powered down while all other devices remain active.

The choices: Disabled, 1 ~ 15 mins.

3.5.5.12 Soft-Off by PWR-BTTN

Pressing the power button for more than 4 seconds forces the system to enter the Soft-Off state when the system has "hung".(Only could working on ATX Power supply)

The choices: Delay 4 Sec, Instant-Off.

3.5.5.13 Wake Up by PCI Card

This will enable the system to wake up through PCI Card peripheral.

The choices: Enable, Disabled.

3.5.5.14 Power On By Ring

This determines whether the system boot up if there's an incoming call from the Modem.

The choices: Enable, Disabled.

3.5.5.15 Resume By Alarm

This function is for setting date and time for your computer to boot up.

The choices: Enabled, Disabled.

3.5.5.16 Date<of Month>/Time<hh:mm:ss> Alarm

After enabled "Resume By Alarm", set the specific date/hour/minute/second specified in these fields.

The choices: Alarm Date: 01-31, Every Day / Alarm Hour: 00-23 /
Alarm Minute: 00-59/ Alarm Second: 00-59

3.5.5.17 Primary/Secondary IDE 0/1, FDD,COM,LPT PORT, PCI PIRQ[A-D]#

Reload Global Timer events are I/O events whose occurrence can prevent the system from entering a power saving mode or can awake the system from such a mode. In effect ,the system remain alert for anything which occurs to a device which is configured as Enabled ,even when the system is in a power down mode.

The choices: Enabled, Disabled.

3.5.6 PnP / PCI Configuration

This section describes configuring the PCI bus system. PCI, or **P**ersonal **C**omputer **I**nterconnect, is a system which allows I/O devices to operate at speeds nearing the speed the CPU itself uses when communicating with its own special components. This section covers some very technical items and it is strongly recommended that only experienced users should make any changes to the default settings.

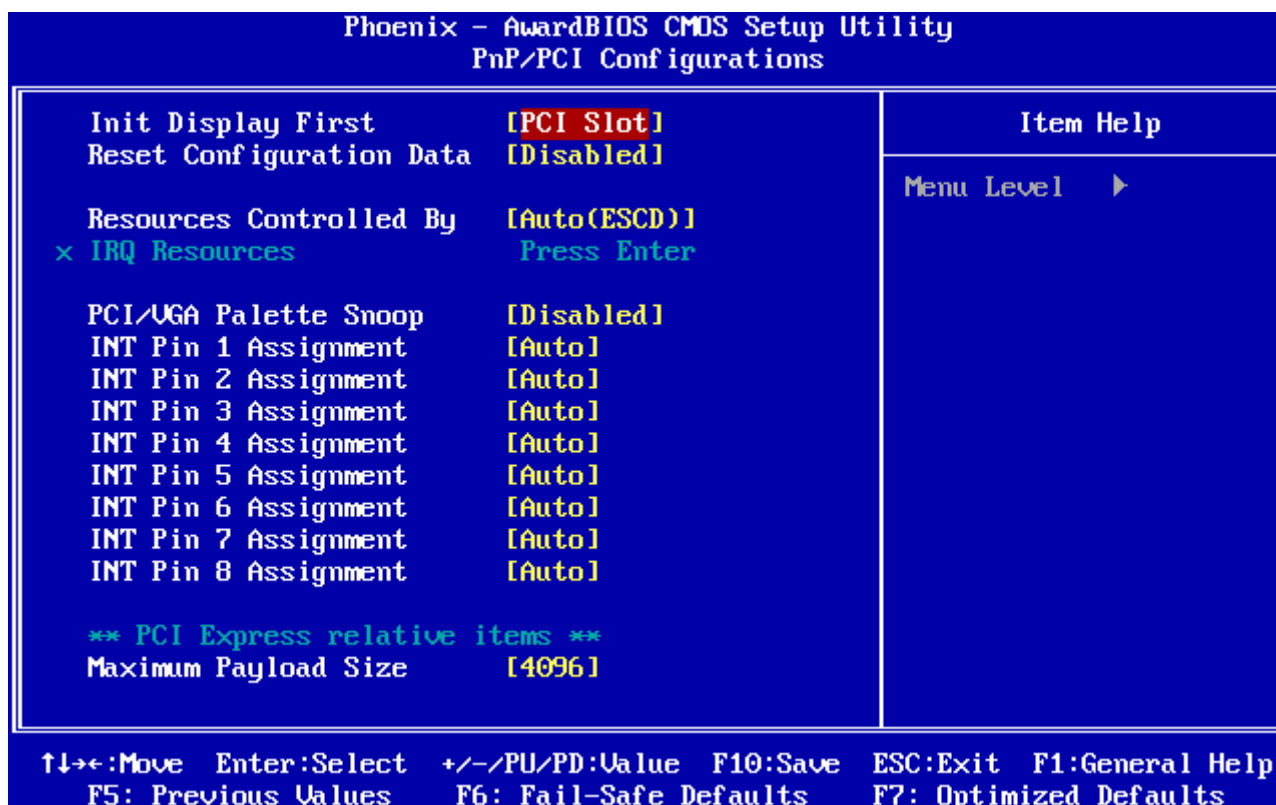

3.5.6.1 Init Display First

It allows you to select whether to boot the system using the AGP graphics card or the PCI graphics card. This is particularly important if you have AGP and PCI graphics cards but only one monitor.

EBM-945GSE

The choices: PCI Slot, Onboard, PCIEx.

3.5.6.2 Reset Configuration Data

Normally, you leave this field Disabled. Select Enabled to reset Extended System Configuration Data (ESCD) when you exit Setup if you have installed a new add-on and the system reconfiguration has caused such a serious conflict that the operating system cannot boot.

The choices: Enabled, Disabled.

3.5.6.3 Resources Controlled By

The Award Plug and Play BIOS has the capacity to automatically configure all of the boot and Plug and Play compatible devices. However, this capability means absolutely nothing unless you are using a Plug and Play operating system such as Windows®95. If you set this field to “manual” choose specific resources by going into each of the sub menu that follows this field (a sub menu is preceded by a “➤”).

The choices: Auto(ESCD), Manual.

3.5.6.4 PCI / VGA Palette Snoop

Leave this field at Disabled.

The choices: Enabled, Disabled.

3.5.6.5 INT Pin 1/2/3/4/5/6/7/8 Assignment

This feature allows you to assign the PCI IRQ numbers for PCI slots. Selecting the default, Auto, allows the PCI controller to automatically allocate the IRQ numbers.

The choices: Auto, 3, 4, 5, 7, 9, 10, 11, 12, 14, 15.

3.5.6.6 Maximum Payload Size

This setting defines the maximum payload size.

The choices: 128, 256, 512, 1024, 2048, 4096.

3.5.7 PC Health Status

This section shows the status of your CPU, Fan & System.

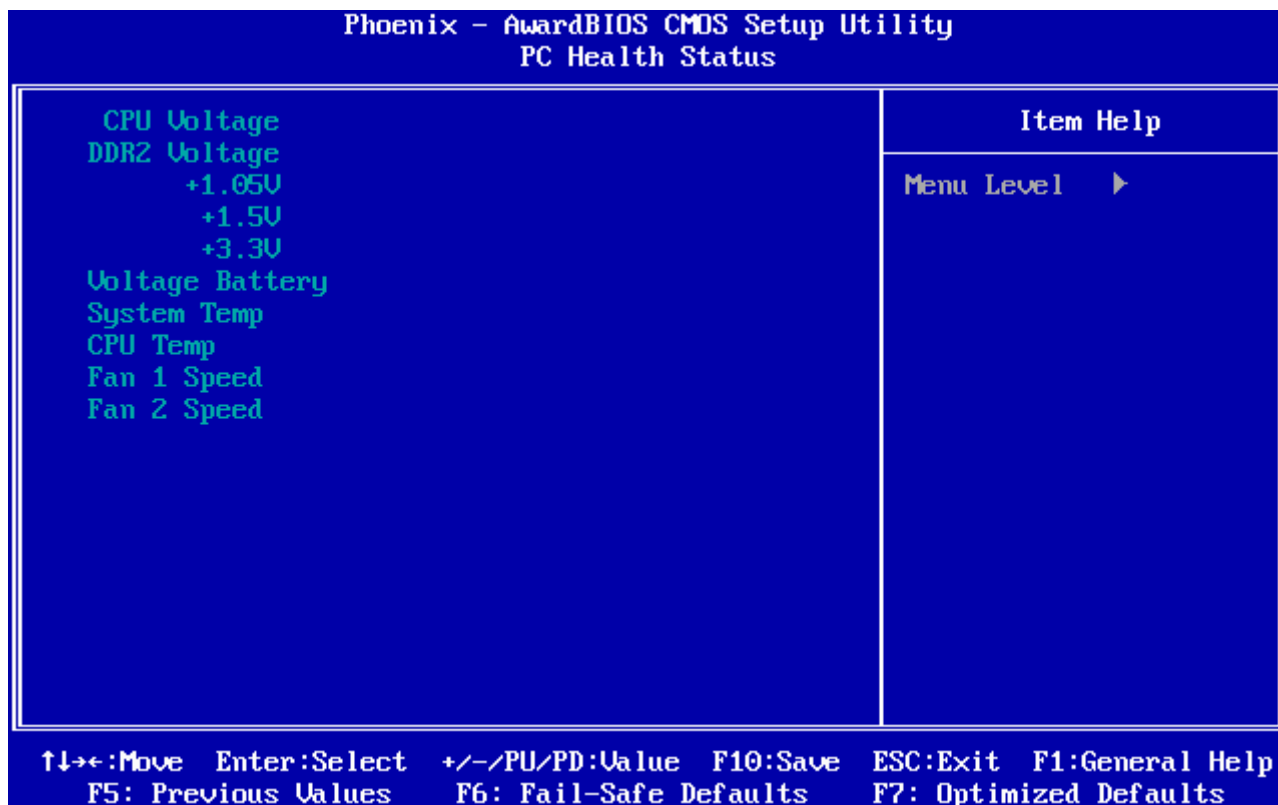

EBM-945GSE

3.5.8 Frequency/ Voltage Control

Use this menu to specify your settings for frequency/voltage control.

3.5.8.1 CPU Clock Ratio

This feature allows owners to change the CPU Clock Ratio.

The choices: 6~50

3.5.9 Load Fail-Safe Defaults

Use this menu to load the BIOS default values for the minimal/stable performance for your system to operate.

Press <Y> to load the BIOS default values for the most stable, minimal-performance system operations.

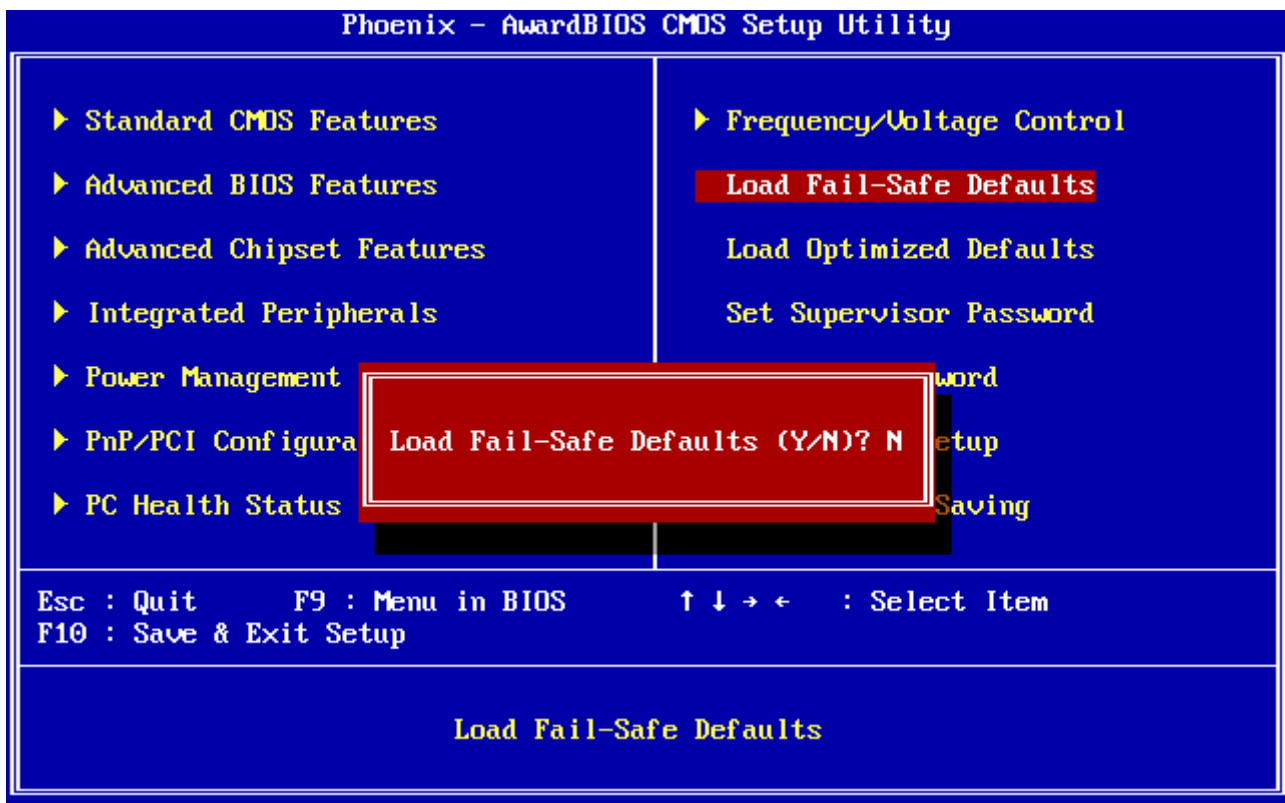

3.5.10 Load Optimized Defaults

Use this menu to load the BIOS default values that are factory settings for optimal performance system operations. While Award has designed the custom BIOS to maximize performance, the factory has the right to change these defaults to meet their needs. Press <Y> to load the default values setting for optimal performance system operations.

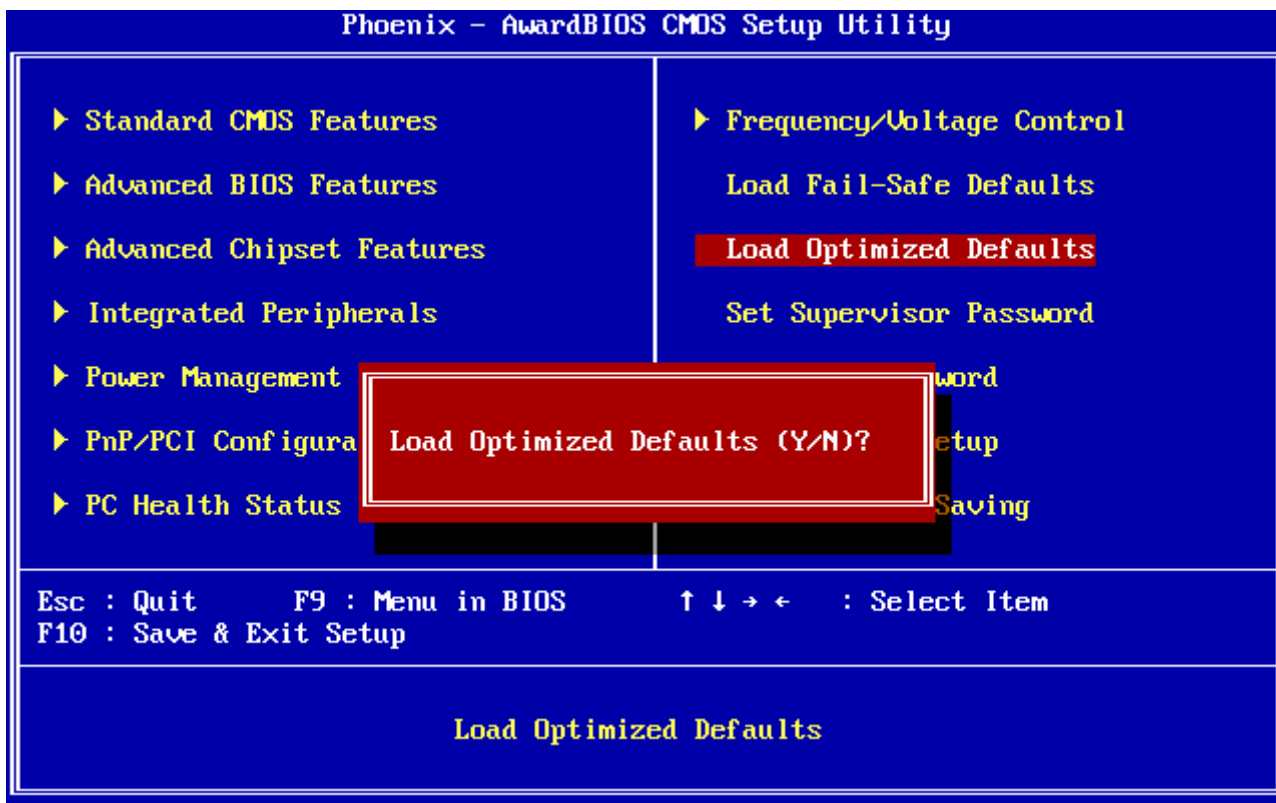

3.5.11 Set Supervisor / User Password

You can set either supervisor or user password, or both of them.

Supervisor Password: able to enter/change the options of setup menus.

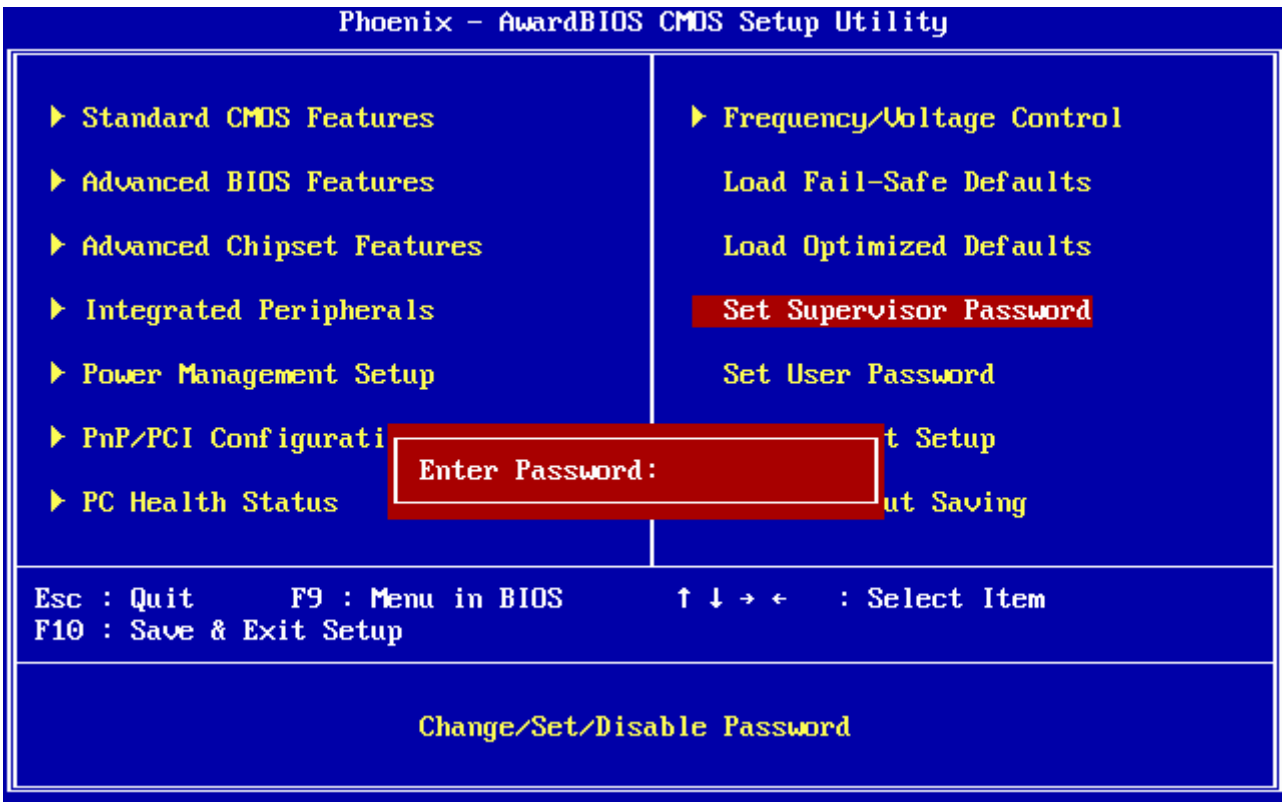

User Password: able to enter but no right to change the options of setup menus.

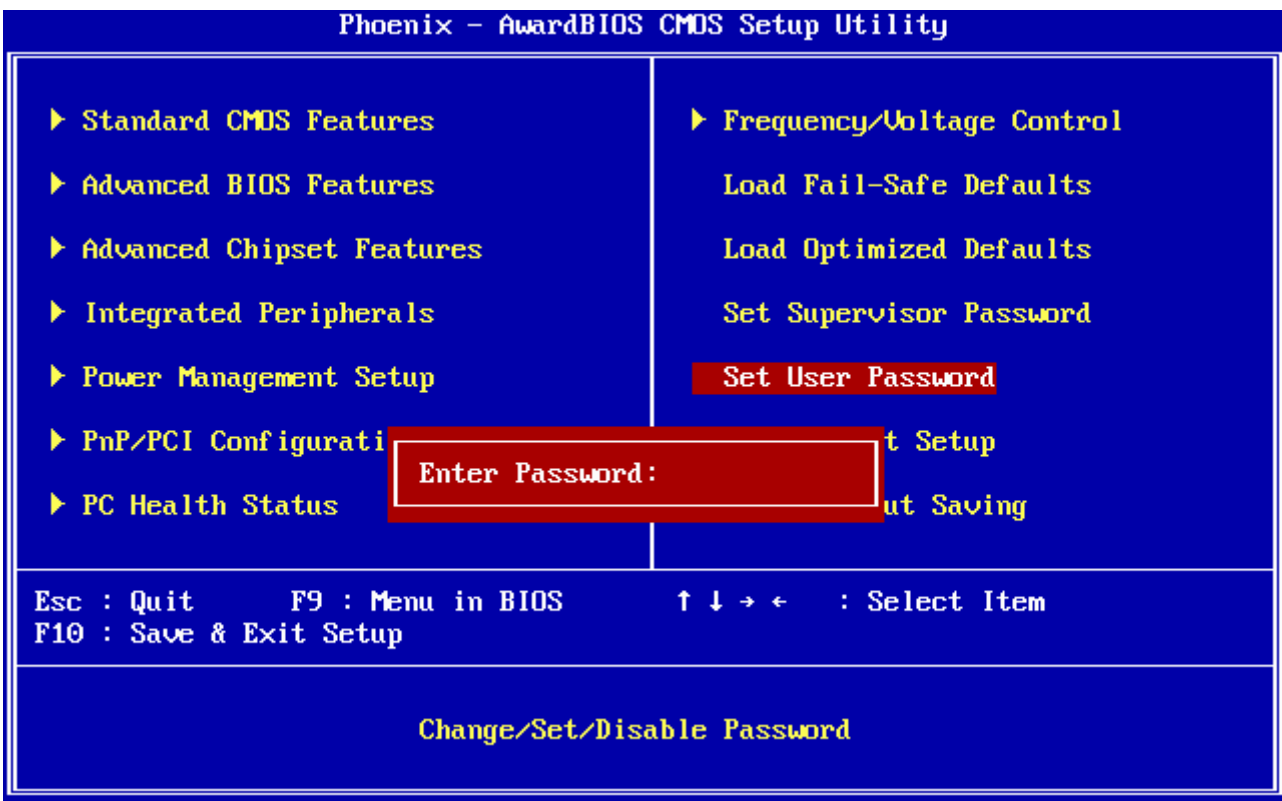

Type the password, up to eight characters in length, and press <Enter>. The password typed now will clear any previously entered password from CMOS memory. You will be asked to confirm the password. Type the password again and press <Enter>. You may also press <Esc> to abort the selection and not enter a password. To disable a password, just press <Enter> when you are prompted to enter the password. A message will confirm the password will be disabled. Once the password is disabled, the system will boot and you can enter Setup freely.

PASSWORD DISABLED.

When a password has been enabled, you will be prompted to enter it every time you try to enter Setup. This prevents an unauthorized person from changing any part of your system configuration. Additionally, when a password is enabled, you can also require the BIOS to request a password every time your system is rebooted. This would prevent unauthorized use of your computer. You determine when the password is required within the BIOS Features Setup Menu and its Security option (see Section 3). If the Security option is set to "System", the password will be required both at boot and at entry to Setup. If set to "Setup", prompting only occurs when trying to enter Setup

3.5.12 Save & Exit Setup

Save CMOS value changes to CMOS and exit setup.

Enter <Y> to store the selection made in the menus in CMOS, a special section in memory that stays on after turning the system off. The BIOS configures the system according to the Setup selection stored in CMOS when boot the computer next time.

The system is restarted after saving the values.

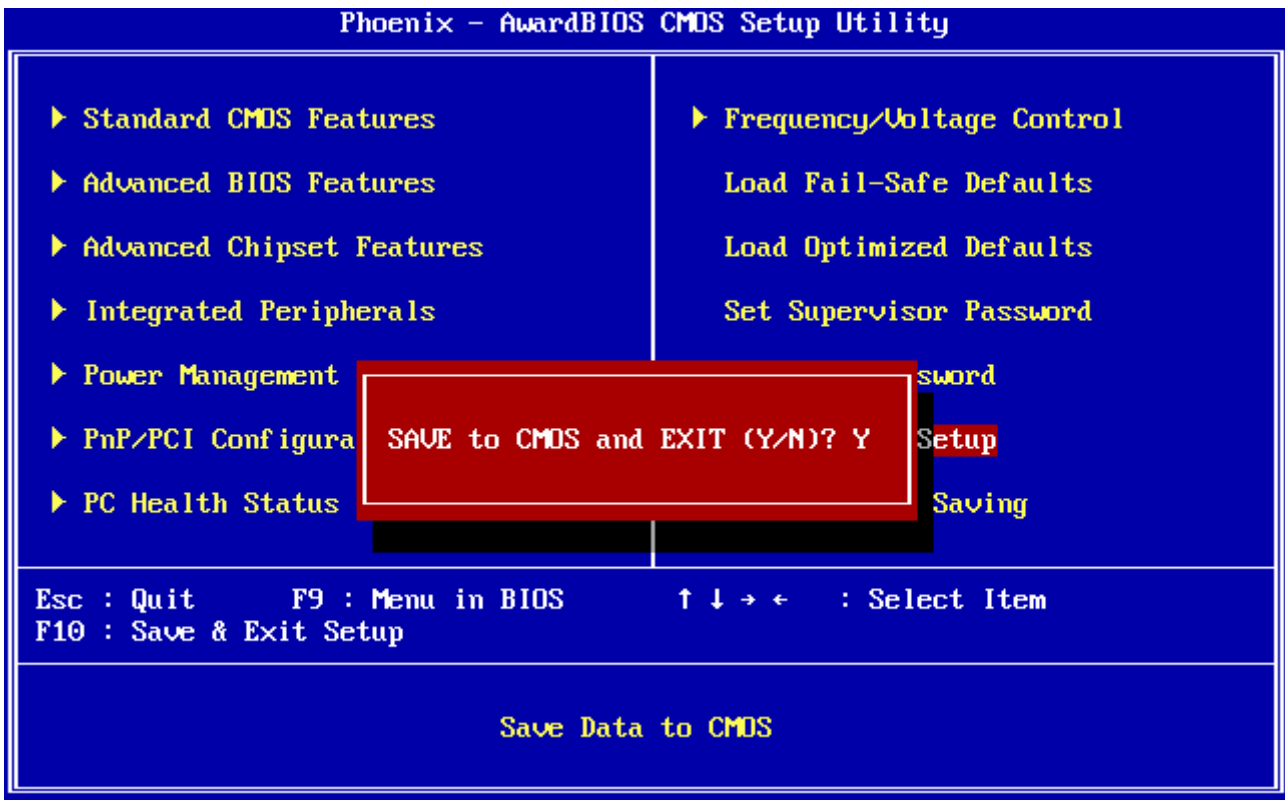

3.5.13 Exit Without Save

Abandon all CMOS value changes and exit setup, and the system is restarted after exiting.

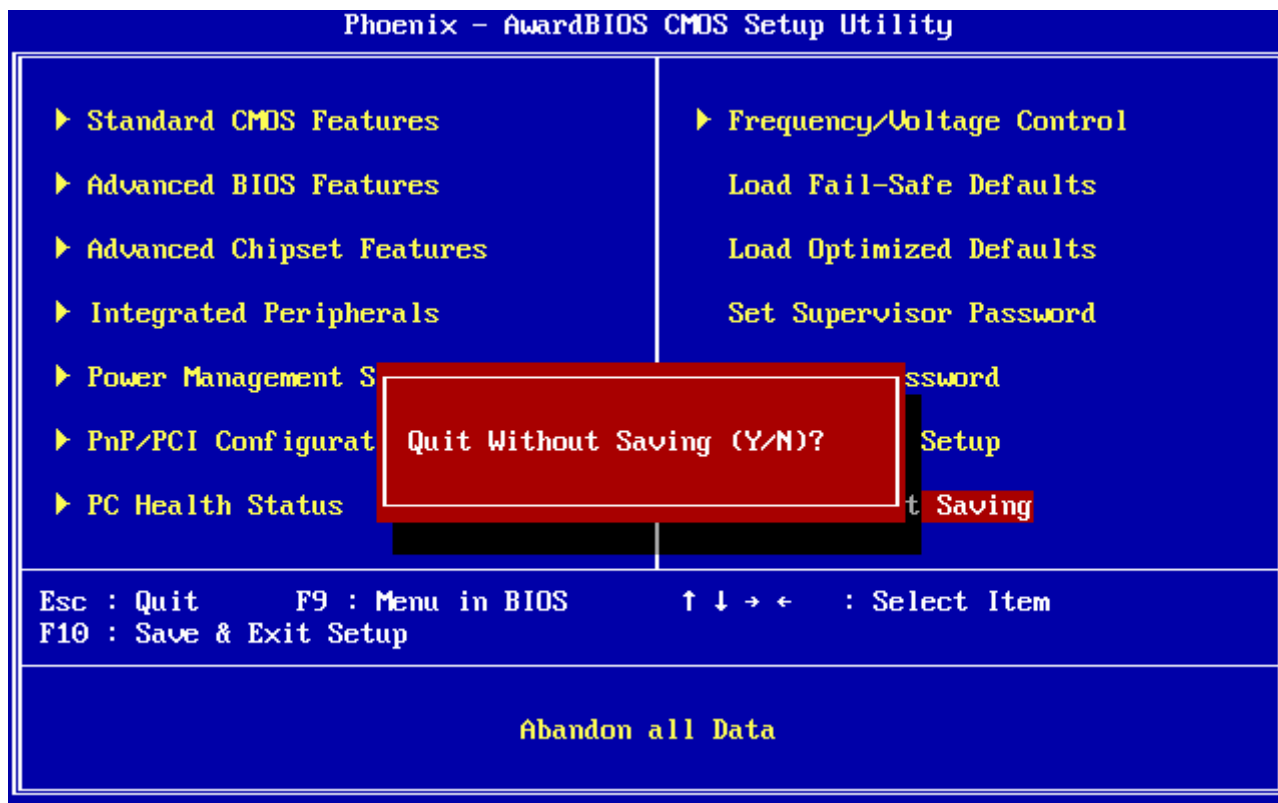

4. Drivers Installation



Note: Installation procedures and screen shots in this section are for your reference and may not be exactly the same as shown on your screen.

4.1 Install Chipset Driver (For Intel 945GSE)

Insert the Supporting DVD-ROM to DVD-ROM drive, and it should show the index page of Avalue's products automatically. If not, locate Index.htm and choose the product from the menu left, or link to \Driver_Chipset\Intel\ 945GSE.



Note: The installation procedures and screen shots in this section are based on Windows XP operation system. If the warning message appears while the installation process, click Continue to go on.

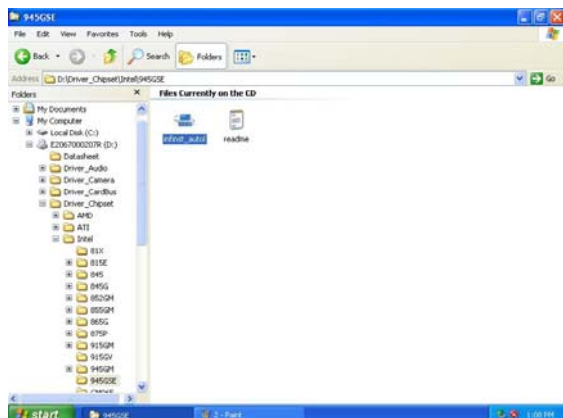

Step1. Locate 「\Driver_Chipset\Intel\ 945GM\ \inst_aut1.exe」.



Step 2. Click **Next**.



Step 3. Click **Next**.



Step 4. Click **Finish** to complete setup.

4.2 Install Display Driver (For Intel 945GSE)

Insert the Supporting DVD-ROM to DVD-ROM drive, and it should show the index page of Avalue's products automatically. If not, locate Index.htm and choose the product from the menu left, or link to **\\Driver_Video\Intel\945GSE**.



Note: The installation procedures and screen shots in this section are based on Windows XP operation system.



Step 3. Click Next.

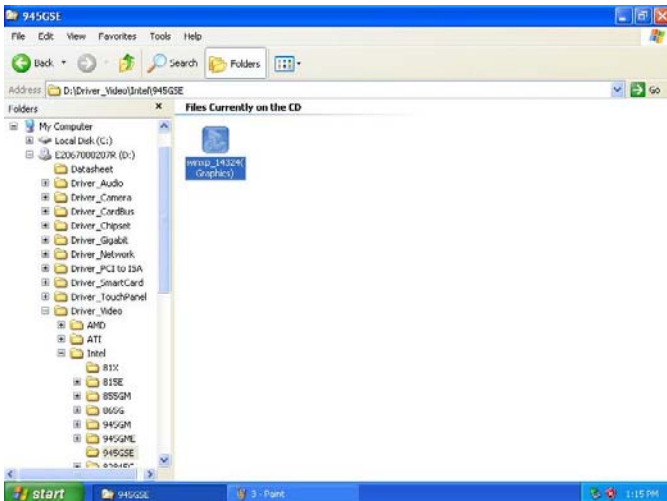

Step 1. Locate 「Driver_Video\Intel\945GSE\winxp_14324(Graphics).exe」.

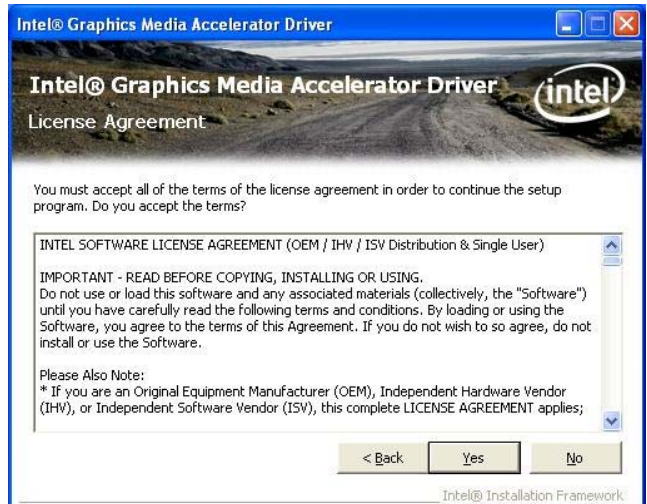

Step 4. Click Yes.

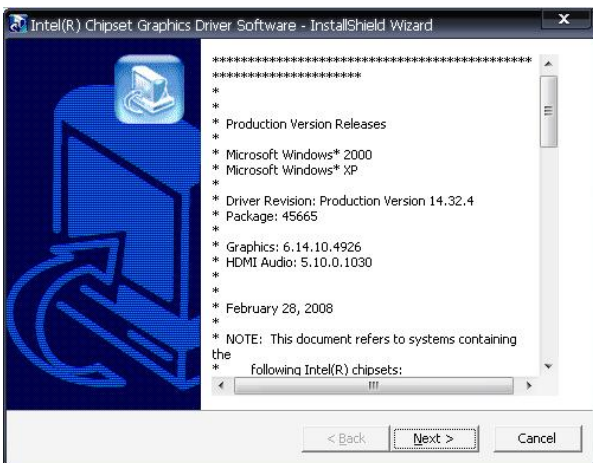

Step 2. Click Next.

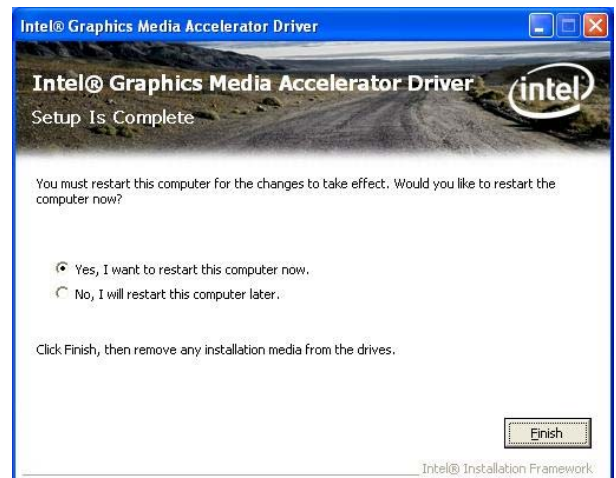

Step 5. Click Finish to complete setup.

4.3 Install Ethernet Driver (For Realtek RTL8111C)

Insert the Supporting DVD-ROM to DVD-ROM drive, and it should show the index page of Avalue's products automatically. If not, locate Index.htm and choose the product from the menu left, or link to **D:\Driver_Gigabit\Realtek\RTL8111C**.



Note: The installation procedures and screen shots in this section are based on Windows XP operation system.

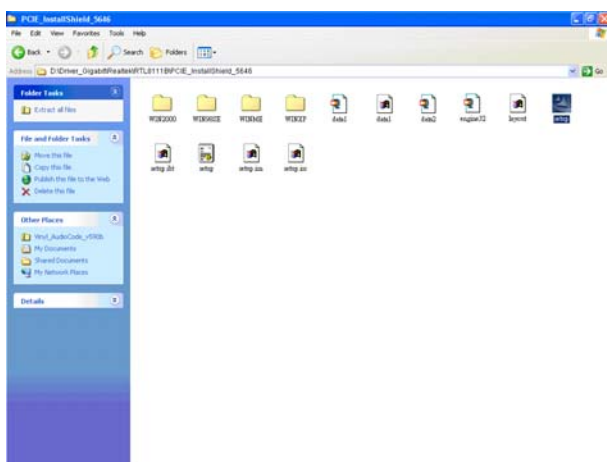

Step 1. Locate 「 \Driver_Gigabit\Realtek\RTL8111C\PCIE_InstallShield_5646\Setup.exe 」 .

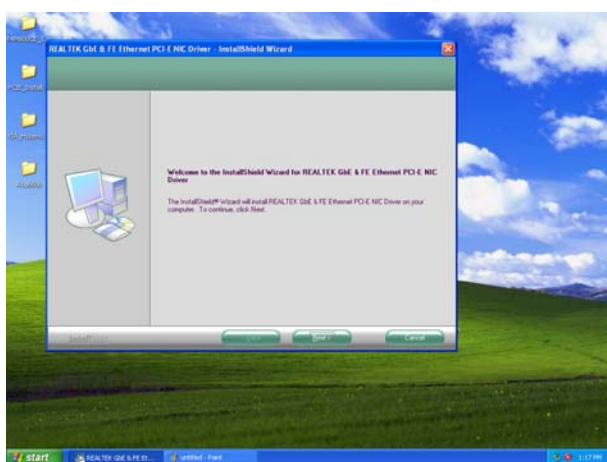

Step 2. Click **Next**.

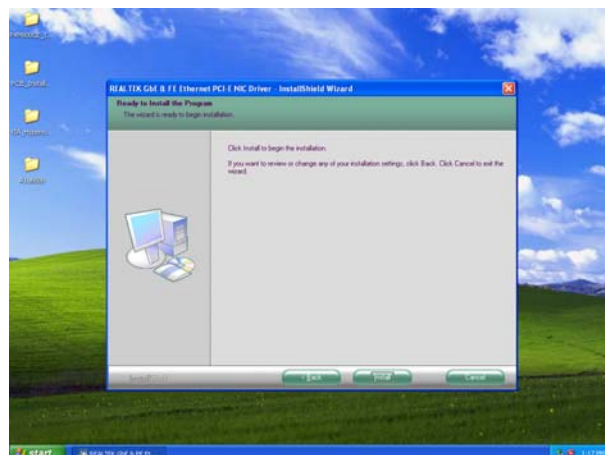

Step 3. Click **Next** to run the installation.

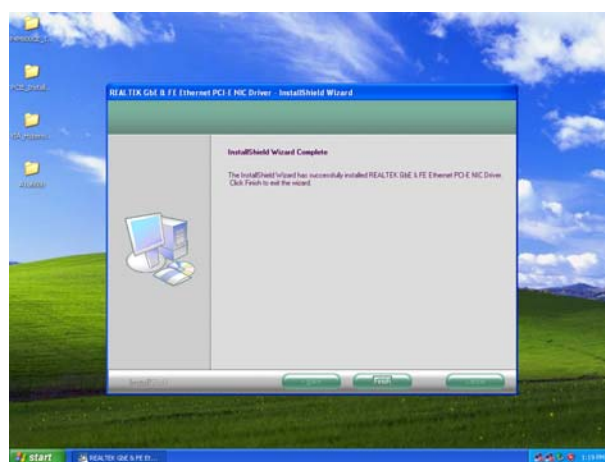

Step 4. Click **Finish** to complete the setup.

4.4 Install Audio Driver (For Realtek ALC655)

Insert the Supporting CD-ROM to CD-ROM drive, and it should show the index page of Avalue's products automatically. If not, locate Index.htm and choose the product from the menu left, or link to `\Drivers\Driver_Audio\Realtek\ALC655`



Note: The installation procedures and screen shots in this section are based on Windows 2000 operation system.

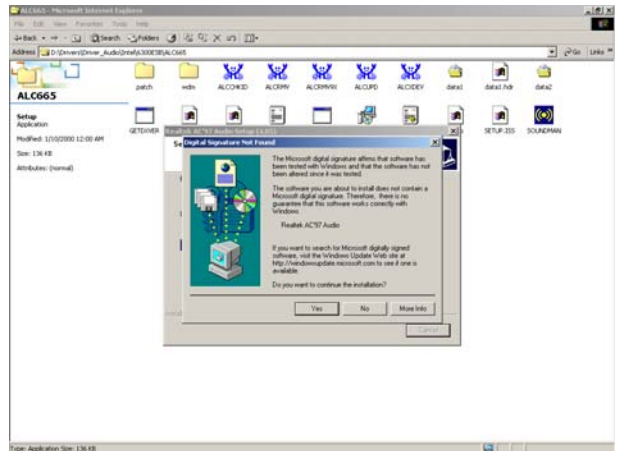

Step 3. Select **Yes** to the next step.

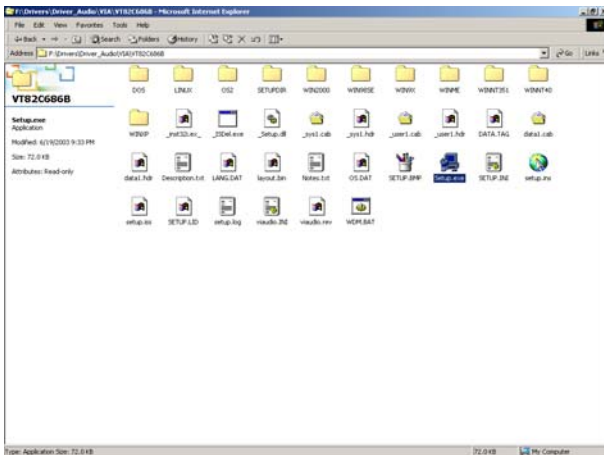

Step 1. Locate `\Drivers\Driver_Audio\Realtek\ALC655\setup.exe`.



Step 4. Click **Finish** to complete the setup.

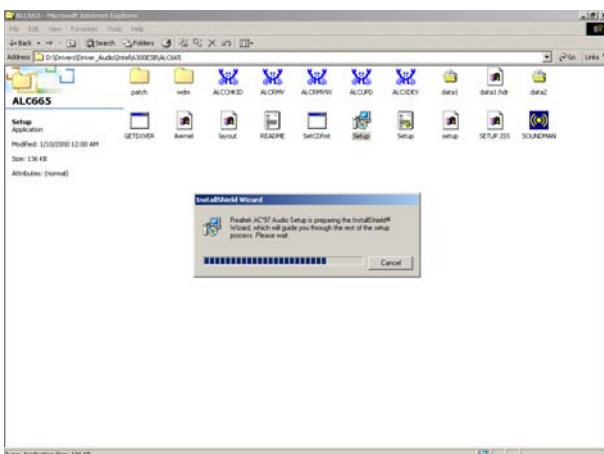

Step 2. The program executes the Setup automatically.

5. Mechanical drawing

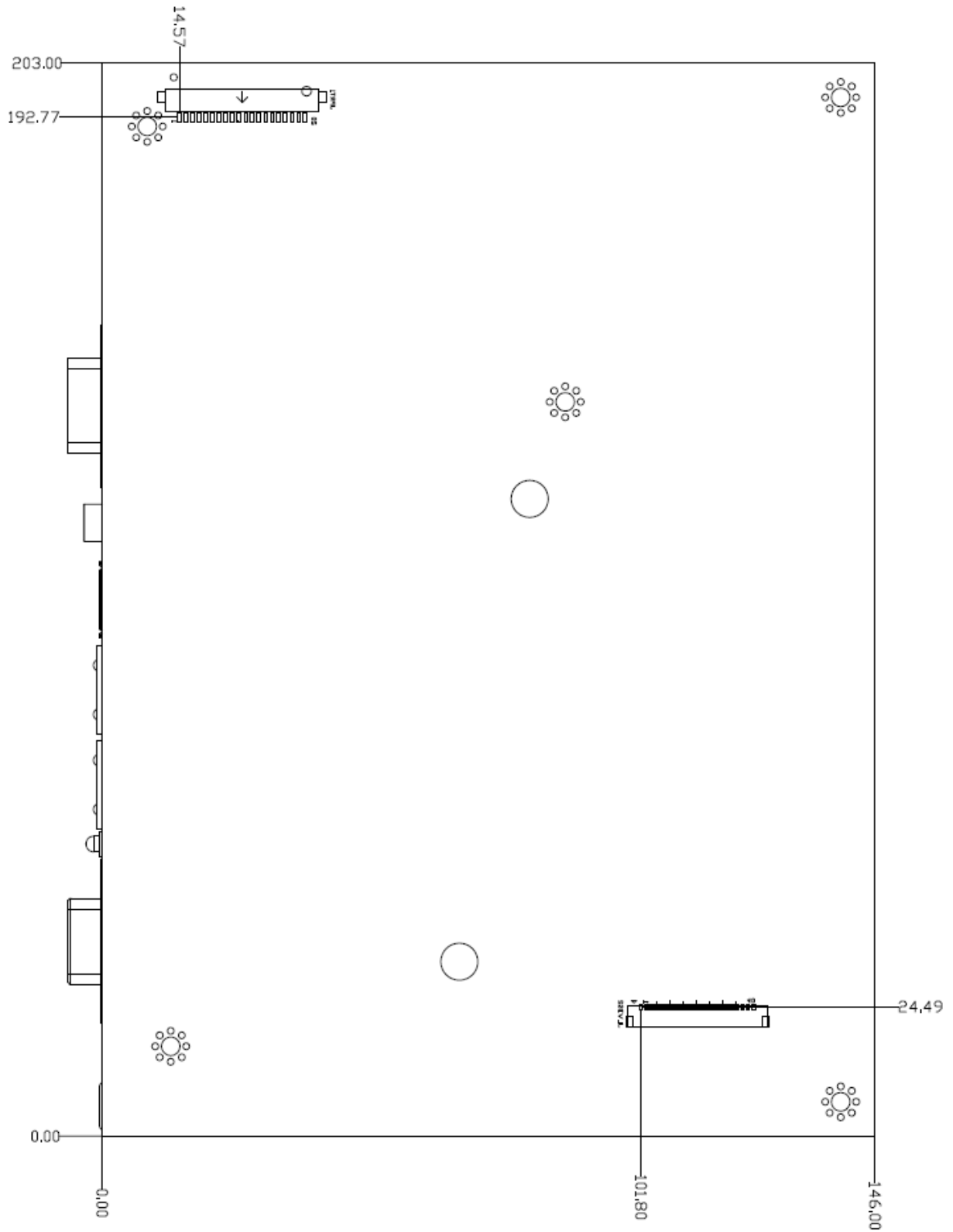

Unit: mm

Appendix A: AWARD BIOS POST Messages

Overview

During the Power On Self-Test (POST), if the BIOS detects an error requiring you to do something to fix, it will either sound a beep code or display a message.

If a message is displayed, it will be accompanied by:

PRESS F1 TO CONTINUE, CTRL-ALT-ESC OR DEL TO ENTER SETUP

Post Beep

Currently there are two kinds of beep codes in BIOS. This code indicates that a video error has occurred and the BIOS cannot initialize the video screen to display any additional information. This beep code consists of a single long beep followed by two short beeps. The other code indicates that your DRAM error has occurred. This beep code consists of a single long beep repeatedly.

Error Messages

One or more of the following messages may be displayed if the BIOS detects an error during the POST. This list includes messages for both the ISA and the EISA BIOS.

1. CMOS BATTERY HAS FAILED

CMOS battery is no longer functional. It should be replaced.

2. CMOS CHECKSUM ERROR

Checksum of CMOS is incorrect. This can indicate that CMOS has become corrupt. This error may have been caused by a weak battery. Check the battery and replace if necessary.

3. DISK BOOT FAILURE, INSERT SYSTEM DISK AND PRESS ENTER

No boot device was found. This could mean that either a boot drive was not detected or the drive does not contain proper system boot files. Insert a system disk into Drive A: and press <Enter>. If you assumed the system would boot from the hard drive, make sure the controller is inserted correctly and all cables are properly attached. Also be sure the disk is formatted as a boot device. Then reboot the system.

4. DISKETTE DRIVES OR TYPES MISMATCH ERROR - RUN SETUP

Type of diskette drive installed in the system is different from the CMOS definition. Run Setup to reconfigure the drive type correctly.

5. DISPLAY SWITCH IS SET INCORRECTLY

Display switch on the motherboard can be set to either monochrome or color. This indicates the switch is set to a different setting than indicated in Setup. Determine which setting is correct, and then either turn off the system and change the jumper, or enter Setup and change the VIDEO selection.

6. DISPLAY TYPE HAS CHANGED SINCE LAST BOOT

Since last powering off the system, the display adapter has been changed. You must configure the system for the new display type.

7. EISA Configuration Checksum Error

PLEASE RUN EISA CONFIGURATION UTILITY

The EISA non-volatile RAM checksum is incorrect or cannot correctly read the EISA slot. This can indicate either the EISA non-volatile memory has become corrupt or the slot has been configured incorrectly. Also be sure the card is installed firmly in the slot.

8. EISA Configuration Is Not Complete

PLEASE RUN EISA CONFIGURATION UTILITY

The slot configuration information stored in the EISA non-volatile memory is incomplete.



Note: When either of these errors appears, the system will boot in ISA mode, which allows you to run the EISA Configuration Utility.

9. ERROR ENCOUNTERED INITIALIZING HARD DRIVE

Hard drive cannot be initialized. Be sure the adapter is installed correctly and all cables are correctly and firmly attached. Also be sure the correct hard drive type is selected in Setup.

10. ERROR INITIALIZING HARD DISK CONTROLLER

Cannot initialize controller. Make sure the cord is correctly and firmly installed in the bus. Be sure the correct hard drive type is selected in Setup. Also check to see if any jumper needs to be set correctly on the hard drive.

11. FLOPPY DISK CNTRLR ERROR OR NO CNTRLR PRESENT

Cannot find or initialize the floppy drive controller. Make sure the controller is installed correctly and firmly. If there are no floppy drives installed, be sure the Diskette Drive selection in Setup is set to NONE.

12. Invalid EISA Configuration

PLEASE RUN EISA CONFIGURATION UTILITY

The non-volatile memory containing EISA configuration information was programmed incorrectly or has become corrupt. Re-run EISA configuration utility to correctly program the memory.



Note: When either of these errors appears, the system will boot in ISA mode, which allows you to run the EISA Configuration Utility.

13. KEYBOARD ERROR OR NO KEYBOARD PRESENT

Cannot initialize the keyboard. Make sure the keyboard is attached correctly and no keys are being pressed during the boot.

If you are purposely configuring the system without a keyboard, set the error halt condition in Setup to HALT ON ALL, BUT KEYBOARD. This will cause the BIOS to ignore the missing keyboard and continue the boot.

14. Memory Address Error at ...

Indicates a memory address error at a specific location. You can use this location along with the memory map for your system to find and replace the bad memory chips.

15. Memory parity Error at ...

Indicates a memory parity error at a specific location. You can use this location along with the memory map for your system to find and replace the bad memory chips.

16. MEMORY SIZE HAS CHANGED SINCE LAST BOOT

Memory has been added or removed since the last boot. In EISA mode use Configuration Utility to reconfigure the memory configuration. In ISA mode enter Setup and enter the new memory size in the memory fields.

17. Memory Verify Error at ...

Indicates an error verifying a value already written to memory. Use the location along with your system's memory map to locate the bad chip.

18. OFFENDING ADDRESS NOT FOUND

This message is used in conjunction with the I/O CHANNEL CHECK and RAM PARITY ERROR messages when the segment that has caused the problem cannot be isolated.

19. OFFENDING SEGMENT:

This message is used in conjunction with the I/O CHANNEL CHECK and RAM PARITY ERROR messages when the segment that has caused the problem has been isolated.

20. PRESS A KEY TO REBOOT

This will be displayed at the bottom screen when an error occurs that requires you to reboot. Press any key and the system will reboot.

21. PRESS F1 TO DISABLE NMI, F2 TO REBOOT

When BIOS detects a Non-maskable Interrupt condition during boot, this will allow you to disable the NMI and continue to boot, or you can reboot the system with the NMI enabled.

22. RAM PARITY ERROR - CHECKING FOR SEGMENT ...

Indicates a parity error in Random Access Memory.

23. Should Be Empty But EISA Board Found

PLEASE RUN EISA CONFIGURATION UTILITY

A valid board ID was found in a slot that was configured as having no board ID.



Note: When either of these errors appears, the system will boot in ISA mode, which allows you to run the EISA Configuration Utility.

24. Should Have EISA Board But Not Found

PLEASE RUN EISA CONFIGURATION UTILITY

The board installed is not responding to the ID request, or no board ID has been found in the indicated slot.



Note: When either of these errors appears, the system will boot in ISA mode, which allows you to run the EISA Configuration Utility.

25. Slot Not Empty

Indicates that a slot designated as empty by the EISA Configuration Utility actually contains a board.



Note: When either of these errors appears, the system will boot in ISA mode, which allows you to run the EISA Configuration Utility.

26. SYSTEM HALTED, (CTRL-ALT-DEL) TO REBOOT ...

Indicates the present boot attempt has been aborted and the system must be rebooted. Press and hold down the CTRL and ALT keys and press DEL.

27. Wrong Board In Slot**PLEASE RUN EISA CONFIGURATION UTILITY**

The board ID does not match the ID stored in the EISA non-volatile memory.



Note: When either of these errors appears, the system will boot in ISA mode, which allows you to run the EISA Configuration Utility.

28. FLOPPY DISK(S) fail (80) → Unable to reset floppy subsystem.

29. FLOPPY DISK(S) fail (40) → Floppy Type mismatch.

30. Hard Disk(s) fail (80) → HDD reset failed.

31. Hard Disk(s) fail (40) → HDD controller diagnostics failed.

32. Hard Disk(s) fail (20) → HDD initialization error.

33. Hard Disk(s) fail (10) → Unable to recalibrate fixed disk.

34. Hard Disk(s) fail (08) → Sector Verify failed.

35. Keyboard is locked out - Unlock the key.

BIOS detect the keyboard is locked. P17 of keyboard controller is pulled low.

36. Keyboard error or no keyboard present.

Cannot initialize the keyboard. Make sure the keyboard is attached correctly and no keys are being pressed during the boot.

37. Manufacturing POST loop.

System will repeat POST procedure infinitely while the P15 of keyboard controller is pull low. This is also used for M/B burn in test.

38. BIOS ROM checksum error - System halted.

The checksum of ROM address F0000H-FFFFFFH is bad.

39. Memory test fail.

BIOS reports the memory test fail if the onboard memory is tested error.

EBM-945GSE

40. POST Codes

Please take reference to Phoenix-Award website for the latest post codes.

<http://www.phoenix.com/en/OEM-ODM/Customer+Services/BIOS/AwardBIOS/Award+Error+Codes.htm>

40.1 Normal POST Code



Note: EISA POST codes are typically output to port address 300h. ISA POST codes are output to port address 80h.

Code (hex)	Name	Description
C0	Turn Off Chipset and CPU test	OEM Specific-Cache control cache Processor Status (1FLAGS) Verification. Tests the following processor status flags: Carry, zero, sign, overflow, the BIOS sets each flag, verifies They are set, then turns each flag off and verifies it is off. Read/Write/Verify all CPU registers except SS, SP, and BP with data pattern FF and 00. RAM must be periodically refreshed to keep the memory from decaying. This function ensures that the memory refresh function is working properly.
C1	Memory Presence	First block memory detect OEM Specific-Test to size on-board memory. Early chip set initialization Memory presence test OEM chip set routines clear low 64K of memory Test first 64K memory.
C2	Early Memory Initialization	OEM Specific- Board Initialization
C3	Extend Memory DRAM select	OEM Specific- Turn on extended memory Initialization Cyrix CPU initialization, Cache initialization
C4	Special Display Handling	OEM Specific- Display/Video Switch handling so that switch handling display switch errors never occurs
C5	Early Shadow	OEM specific- Early shadow enable for fast boot
C6	Cache presence test	External cache size detection
CF	CMOS Check	CMOS checkup
B0	Spurious	If interrupt occurs in protected mode.
B1	Unclaimed NMI	If unmasked NMI occurs, display Press F1 to disable NMI, F2 reboot.
BF	Program Chip Set	To program chipset from defaults values
E1-EF	Setup Pages	E1- Page 1, E2 - Page 2, etc.
1	Force load Default to chipset	Chipset defaults program
2	Reserved	

Code (hex)	Name	Description
3	Early Superio Init	Early Initialized the super IO
4	Reserved	
5	Blank video	Reset Video controller
6	Reserved	
7	Init KBC	Keyboard controller init
8	KB test	Test the Keyboard
9	Reserved	
A	Mouse Init	Initialized the mouse
B	Onboard Audio init	Onboard audio controller initialize if exist
C	Reserved	
D	Reserved	
E	CheckSum Check	Check the intergraty of the ROM, BIOS and message
F	Reserved	
10	Auto detec EEPROM	Check Flash type and copy flash write/erase routines to 0F000h segments
11	Reserved	
12	Cmos Check	Check Cmos Circuitry and reset CMOS
13	Reserved	
14	Chipset Default load	Program the chipset registers with CMOS values
15	Reserved	
16	Clock Init	Init onboard clock generator
17	Reserved	
18	Identify the CPU	Check the CPU ID and init L1/L2 cache
19	Reserved	
1A	Reserved	
1B	Setup Interrupt Vector Table	Initialize first 120 interrupt vectors with SPURIOUS_INT_HDLR and initialize INT 00h-1Fh according to INT_TBL
1C	Reserved	
1D	Early PM Init	First step initialize if single CPU onboard
1E	Reserved	
1F	Re-initial KB	Re-init KB
20	Reserved	
21	HPM init	If support HPM, HPM get initialized here
22	Reserved	
23	Test CMOS Interface and battery Status	Verifies CMOS is working correctly, detects bad battery. If failed, load CMOS defaults and load into chipset
24	Reserved	

EBM-945GSE

Code (hex)	Name	Description
25	Reserved	
26	Reserved	
27	KBC final Init	Final Initial KBC and setup BIOS data area
28	Reserved	
29	Initialize Video Interface	Read CMOS location 14h to find out type of video in use. Detect and Initialize Video Adapter.
2A	Reserved	
2B	Reserved	
2C	Reserved	
2D	Video memory test	Test video memory, write sign-on message to screen. Setup shadow RAM - Enable shadow according to Setup.
2E	Reserved	
2F	Reserved	
30	Reserved	
31	Reserved	
32	Reserved	
33	PS2 Mouse setup	Setup PS2 Mouse and reset KB
34	Reserved	
35	Test DMA Controller 0	Test DMA Controller 0
36	Reserved	
37	Test DMA Controller 1	Test DMA Controller 1
38	Reserved	
39	Test DMA Page Registers	Test DMA Page Registers.
3A	Reserved	
3B	Reserved	
3C	Test Timer Counter 2	Test 8254 Timer 0 Counter 2.
3D	Reserved	
3E	Test 8259-1 Mask Bits	Verify 8259 Channel 1 masked interrupts by alternately turning off and on the interrupt lines.
3F	Reserved	
40	Test 8259-2 Mask Bits	Verify 8259 Channel 2 masked interrupts by alternately turning off and on the interrupt lines.
41	Reserved	
42	Reserved	

Code (hex)	Name	Description
43	Test Stuck 8259's Interrupt Bits Test 8259 Interrupt Functionality	Turn off interrupts then verify no interrupt mask register is on. Force an interrupt and verify the interrupt occurred.
44	Reserved	
45	Reserved	
46	Reserved	
47	Set EISA Mode	If EISA non-volatile memory checksum is good, execute EISA initialization. If not, execute ISA tests and clear EISA mode flag.
48	Reserved	
49	Size Base and Extended Memory	Size base memory from 256K to 640K and extended memory above 1MB.
4A	Reserved	
4B	Reserved	
4C	Reserved	
4D	Reserved	
4E	Test Base and Extended Memory	Test base memory from 256K to 640K and extended memory above 1MB using various patterns. NOTE: This test is skipped in EISA mode and can be skipped with ESC key in ISA mode.
4F	Reserved	
50	USB init	Initialize USB controller
51	Reserved	
52	Memory Test	Test all memory of memory above 1MB using Virtual 8086 mode, page mode and clear the memory
53	Reserved	
54	Reserved	
55	CPU display	Detect CPU speed and display CPU vendor specific version string and turn on all necessary CPU features
56	Reserved	
57	PnP Init	Display PnP logo and PnP early init
58	Reserved	
59	Setup Virus Protect	Setup virus protect according to Setup
5A	Reserved	
5B	Awdflash Load	If required, will auto load Awdflash.exe in POST
5C	Reserved	
5D	Onboard I/O Init	Initializing onboard superIO

EBM-945GSE

Code (hex)	Name	Description
5E	Reserved	
5F	Reserved	
60	Setup enable	Display setup message and enable setup functions
61	Reserved	
62	Reserved	
63	Initialize & Install Mouse	Detect if mouse is present, initialize mouse, install interrupt vectors.
64	Reserved	
65	PS2 Mouse special	Special treatment to PS2 Mouse port
66	Reserved	
67	ACPI init	ACPI sub-system initializing
68	Reserved	
69	Setup Cache Controller	Initialize cache controller.
6A	Reserved	
6B	Setup Entering	Enter setup check and auto- configuration check up
6C	Reserved	
6D	Initialize Floppy Drive & Controller	Initialize floppy disk drive controller and any drives.
6E	Reserved	
6F	FDD install	Install FDD and setup BIOS data area parameters
70	Reserved	
71	Reserved	
72	Reserved	
73	Initialize Hard Drive & Controller	Initialize hard drive controller and any drives.
74	Reserved	
75	Install HDD	IDE device detection and install
76	Reserved	
77	Detect & Initialize Serial/Parallel Port	Initialize any serial and parallel ports (also game port).
78	Reserved	
79	Reserved	
7A	Detect & Initialize Math Coprocessor	Initialize math coprocessor.
7B	Reserved	
7C	HDD Check for Write protection	HDD check out

Code (hex)	Name	Description
7D	Reserved	
7E	Reserved	
7F	POST error check	Check POST error and display them and ask for user intervention
80	Reserved	
81	Reserved	
82	Security Check	Ask password security (optional).
83	Write CMOS	Write all CMOS values back to RAM and clear screen.
84	Pre-boot Enable	Enable parity checker. Enable NMI, Enable cache before boot.
85	Initialize Option ROMs	Initialize any option ROMs present from C8000h to EFFFFh. NOTE: When FSCAN option is enabled, ROMs initialize from C8000h to F7FFFh.
86	Reserved	
87	Reserved	
88	Reserved	
89	Reserved	
8A	Reserved	
8B	Reserved	
8C	Reserved	
8D	Reserved	
8E	Reserved	
8F	Reserved	
90	Reserved	
91	Reserved	
92	Reserved	
93	Boot Medium detection	Read and store boot partition head and cylinders values in RAM
94	Final Init	Final init for last micro details before boot
95	Special KBC patch	Set system speed for boot. Setup NumLock status according to Setup
96	Boot Attempt	Set low stack Boot via INT 19h.
FF	Boot	

40.2 Quick POST Codes

Code (hex)	Name	Description
65	Init onboard device	Early Initialized the super IO. Reset Video controller. Keyboard controller init Test the Keyboard Initialized the mouse Onboard audio controller initialize if exist. Check the intergraty of the ROM, BIOS and message Check Flash type and copy flash write/erase routines to 0F000h segments Check Cmos Circuitry and reset CMOS Program the chipset registers with CMOS values Init onboard clock generator
66	Early Sytem setup	Check the CPU ID and init L1/L2 cache. Initialize first 120 interrupt vectors with SPURIOUS_INT_HDLR and 10 initialize INT 00h-1Fh according to INT_TBL First step initialize if single CPU onboard. Re-init KB If support HPM, HPM get initialized here.
67	KBC and CMOS Init	Verifies CMOS is working correctly, detects bad battery. If failed, load CMOS defaults and load into chipset. Final Initial KBC and setup BIOS data area.
68	Video Init	Read CMOS location 14h to find out type of video in use. Detect and Initialize Video Adapter. Test video memory, write sign-on message to screen. Setup shadow RAM - Enable shadow according to Setup.
69	8259 Init	Init 8259 channel 1 and mask IRQ 9
6A	Memory test	Quick Memory Test
6B	CPU Detect and IO init	CPU vendor specific version string and turn on all necessary CPU features Display PnP logo and PnP early init Setup virus protect according to Setup. If required, will auto load Awdflash.exe in POST Initializing onboard superIO
6C	Reserved	
6D	Reserved	
6E	Reserved	
6F	Reserved	
70	Setup Init	Display setup message and enable setup functions Detect if mouse is present, initialize mouse, install interrupt vectors. Special treatment to PS2 Mouse port ACPI sub-system initializing
71	Setup Cache Controller	Initialize cache controller.

Code (hex)	Name	Description
72	Install FDD	Enter setup check and auto11 configuration check up Initialize floppy disk drive controller and any drives. Install FDD and setup BIOS data area parameters
73	Install FDD	Initialize hard drive controller and any drives. IDE device detection and install Initialize any serial and parallel ports (also game port).
74	Detect & Initialize Math Coprocessor	Initialize math coprocessor.
75	HDD Check for Write protection	HDD check out
76	Reserved	
77	Display POST error	Check POST error and display them and ask for user intervention Ask password security (optional).
78	CMOS and Option ROM Init	Write all CMOS values back to RAM and clear screen. Enable parity checker Enable NMI, Enable cache before boot. Initialize any option ROMs present from C8000h to EFFFFh. NOTE: When FSCAN option is enabled, ROMs initialize from C8000h to F7FFFh.
79	Reserved	
7A	Reserved	
7B	Reserved	
7C	Reserved	
7D	Boot Medium detection	Read and store boot partition head and cylinders values in RAM
7E	Final Init	Final init for last micro details before boot
7F	Special KBC patch	Set system speed for boot. Setup NumLock status according to Setup.
80	Boot Attempt	Set low stack Boot via INT 19h.
FF	Boot	

EBM-945GSE

40.3S4 POST Codes

Code (hex)	Name	Description
5A	Early Chipset Init	Early Initialized the super IO. Reset Video controller. Keyboard controller init. Test the Keyboard Initilized the mouse
5B	Cmos Check	Check Cmos Circuitry and reset CMOS
5C	Chipset default Prog	Program the chipset registers with CMOS values. Init onboard clock generator
5D	Identify the CPU	Check the CPU ID and init L1/L2 cache Initialize first 120 interrupt vectors with SPURIOUS_INT_HDLR and INT 00h-1Fh according to INT_TBL. First step initialize if single CPU Onboard. Re-init KB If support HPM, HPM get initialized Here.
5E	Setup Interrupt Vector Table	Initialize first 120 interrupt vectors with SPURIOUS_INT_HDLR and INT 00h-1Fh according to INT_TBL. First step initialize if single CPU Onboard. Re-init KB If support HPM, HPM get initialized here.
5F	Test CMOS Interface and Battery status	Verifies CMOS is working correctly, detects bad battery. If failed, load CMOS defaults and load into chipset.
60	KBC final Init	Final Initial KBC and setup BIOS data area
61	Initialize Video Interface	Read CMOS location 14h to find out type of video in use. Detect and Initialize Video Adapter.
62	Video memory test	Test video memory, write sign-on Test video memory, write sign-on message to screen. Setup shadow RAM - Enable shadow according to Setup.
63	Setup PS2 mouse and test DMA	Setup PS2 Mouse and reset KB Test DMA channel 0
64	Test 8259	Test 8259 channel 1 and mask IRQ 9
65	Init Boot Device	Detect if mouse is present, initialize mouse, install interrupt vectors. Special treatment to PS2 Mouse port ACPI sub-system initializing Initialize cache controller.
66	Install Boot Devices	Enter setup check and auto-configuration check up Initialize floppy disk drive controller and any drives. Install FDD and setup BIOS data area Parameters Initialize hard drive controller and any drives. IDE device detection and install
67	Cache Init	Cache init and USB init
68	PM init	PM initialization
69	PM final Init and issue SMI	Final init Before resume
FF	Full on	

40.4 BootBlock POST Codes

Code (hex)	Name	Description
1	Base memory test	Clear base memory area (0000:0000--9000:ffffh)
5	KB init	Initialized KBC
12	Install interrupt vectors	Install int. vector (0-77), and initialized 00-1fh to their proper place
0D	Init Video	Video initializing
41	Init FDD	Scan floppy and media capacity for onboard superIO
FF	Boot	Load boot sector