

ASTUT-xx1-PC1S

User Manual

Revision	Release Date
V0.2	2014/06/25

Copyright © 2013 IBASE Technology Inc. All Rights Reserved.

No part of this manual, including the products and software described in it, may be reproduced, transmitted, transcribed, stored in a retrieval system, or translated into any language in any form or by any means, except documentation kept by the purchaser for backup purposes, without the express written permission of IBASE Technology INC. ("IBASE").

Products and corporate names mentioned in this manual may or may not be registered trademarks or copyrights of their respective companies, and are used for identification purposes only. All trademarks are the property of their respective owners.

Every effort has been made to ensure that the contents of this manual are correct and up to date. However, the manufacturer makes no guarantee regarding the accuracy of its contents, and reserves the right to make changes without prior notice.

Table of Contents

<i>Safety Information</i>	<i>iii</i>
Setting up your system	iii
Care during use	iv
Acknowledgments	v
CHAPTER 1 INTRODUCTION	1
1.1 General Description	1
1.2 System Specification	2
1.2.1 Hardware Specifications	2
1.2.2 Dimensions	3
1.2.3 I/O View	4
1.3 Accessory List	4
1.4 Installation	5
1.4.1 Installing HDD/SSD	5
1.4.2 Installing CFast	7
1.4.3 Installing additional PCI card	8
CHAPTER 2 MOTHERBOARD INTRODUCTION	12
2.1 Introduction	12
Board Dimensions	14
2.2 Setting Jumpers	15
CHAPTER 3 BIOS SETUP	36
3.1 BIOS Introduction	36
3.2 BIOS Setup	36
3.3 Advanced Settings	37
PCI Subsystem Settings	38
3.4 Chipset Settings	47
CHAPTER 4 DRIVERS INSTALLATION	59
4.1 Intel Chipset Software Installation Utility	59
4.2 VGA Drivers Installation	61
4.3 Realtek HD Audio Driver Installation	63
4.4 Realtek LAN Controller Drivers Installation	65

Safety Information

Your ASTUT series is designed and tested to meet the latest standards of safety for information technology equipment. However, to ensure your safety, it is important that you read the following safety instructions

Setting up your system

- Read and follow all instructions in the documentation before you operate your system.
- Do not use this product near water.
- Set up the system on a stable surface. Do not secure the system on any unstable plane.
- Do not place this product on an unstable cart, stand, or table. The product may fall, causing serious damage to the product.
- Slots and openings on the chassis are for ventilation. Do not block or cover these openings. Make sure you leave plenty of space around the system for ventilation.
Never insert objects of any kind into the ventilation openings.
- This system should be operated from the type of power indicated on the marking label. If you are not sure of the type of power available, consult your dealer or local power company.
- Use this product in environments with ambient temperatures between 0°C and 50°C.
- If you use an extension cord, make sure that the total ampere rating of the devices plugged into the extension cord does not exceed its ampere rating.
- DO NOT LEAVE THIS EQUIPMENT IN AN ENVIRONMENT WHERE THE STORAGE TEMPERATURE MAY GO BELOW -20° C OR ABOVE 60° C. THIS COULD DAMAGE THE EQUIPMENT. THE EQUIPMENT SHOULD BE IN A CONTROLLED ENVIRONMENT.

Care during use

- Do not walk on the power cord or allow anything to rest on it.
- Do not spill water or any other liquids on your system.
- When the system is turned off, a small amount of electrical current still flows. Always unplug all power, and network cables from the power outlets before cleaning the system.
- If you encounter the following technical problems with the product, unplug the power cord and contact a qualified service technician or your retailer.
 - The power cord or plug is damaged.
 - Liquid has been spilled into the system.
 - The system does not function properly even if you follow the operating instructions.
 - The system was dropped or the cabinet is damaged.

Lithium-Ion Battery Warning

CAUTION: Danger of explosion if battery is incorrectly replaced. Replace only with the same or equivalent type recommended by the manufacturer. Dispose of used batteries according to the manufacturer's instructions.

NO DISASSEMBLY

The warranty does not apply to the products that have been disassembled by users.

WARNING

HAZARDOUS MOVING PARTS

KEEP FINGERS AND OTHER BODY PARTS AWAY

Acknowledgments

- AMI is a registered trademark of AMI Software International, Inc.
- AMD and ATI are registered trademarks of AMD Corporation.
- Microsoft Windows is a registered trademark of Microsoft Corporation.
- FINTEK is a registered trademark of FINTEK Electronics Corporation.
- REALTEK is a registered trademark of REALTEK Electronics Corporation.
- All other product names or trademarks are properties of their respective owners.

CHAPTER 1 INTRODUCTION

1.1 General Description

ASTUT series, an ALL in ONE Panel PC utilizes the dual-core 1.86GHz Intel® Atom™ Processor D2550 and Intel® NM10 chipset to provide high computing performance and low power consumption. It includes 15- and 18.5-inch sizes.

The fanless ASTUT series operates silently and reliably in harsh environments. It comes with two SODIMM slots to accommodate up to 4GB of DDR3 1033/1066MHz system memory and one 2.5" SATA HDD and external CFast slot for data storage. It is provided with two Gigabit Ethernet, two isolated RS-232/422/485 ports, as well as an overload protected 2-in/2-out GPIO feature. The unit is equipped with a front bezel that has IP65-rated protection.

The ASTUT series supports a wide range 12V~36V DC power input, using an 84W power adaptor, which makes it ideal for factory automation or any other industrial applications.



ASTUT-xx1-PC1S overview

1.2 System Specification

1.2.1 Hardware Specifications

Model Name	ASTUT-151-PC1S	ASTUT-181-PC1S
System Mainboard	IB809	
CPU	Intel® Atom™ Processor D2550 (1M Cache, 1.86 GHz)	
Chipset	Intel® NM10 PCH	
Memory	2 x DDR3-1033 /1066 SO-DIMM, up to 4GB, Default 4GB(4GBx1)	
I/O Interface	4 x USB 2.0 1 x VGA 2 x isolated RS-232/422/485, COM1/2 1 x RS-232, COM3 1 x Line-out phone jack 1 x Mic-in phone jack 2 x Gigabit LAN (RJ45) 1 x 6 pins terminal block GPIO 2in/2out/5VCC/Ground 1 x 3pin DC power connector 1 x Power on/off rock switch, 1 x power on LED	
Storage	1 x 2.5" SATA2 ; 1 x external CFast	
Expansion Slots	1 x PCI	
Power Supply	12~36V Wide Range DC input	
LCD Size	15" TFT LCD	18.5" TFT LCD
LCD Color	16.2M	16.7M
LCD Resolution	1024 x 768	1366 x 768
LCD Brightness	400	300
LCD View Angle (H°/V°)	160/140	170/160
Backlight MTBF	50,000 hrs	
Touch Screen	Projected capacitive touch	
Construction	Black aluminum front bezel and black steel back cover with aluminum heat-sink	
Mounting	Panel Mount, VESA 75X75/100x100 mm	
Dimensions (W)x(D)x(H) mm	390 x 315 x 85	520 x 341 x 84.4
Operating Temperature	0°C~ 50°C(With SSD/CFast) / 0°C~ 40°C(with HDD)	
Storage Temperature	-20°C ~ 60°C	
Relative Humidity	10%~90% (non-condensing)	
Protection Class	IP65 (Front panel with panel mount)	
Operating System Support	Windows Embedded Standard 7, Windows 7 Pro for Embedded	

•This specification is subject to change without prior notice.

1.2.2 Dimensions

ASTUT-151-PC1S

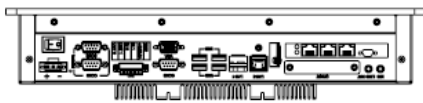
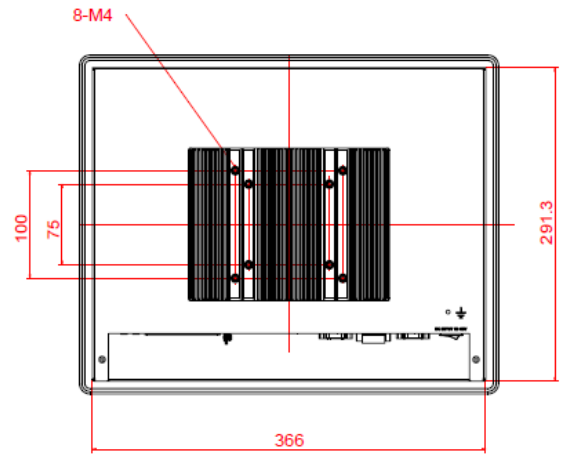
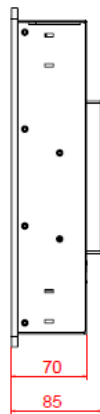
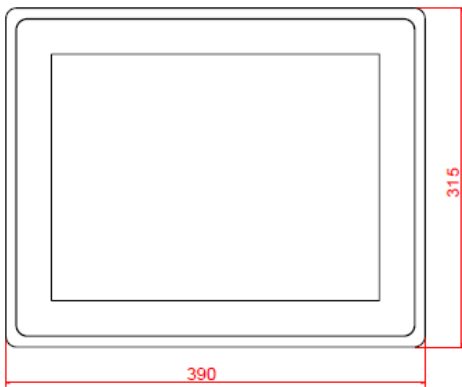
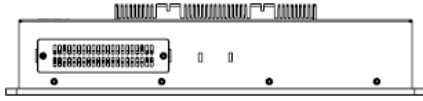

ASTUT-181-PC1S

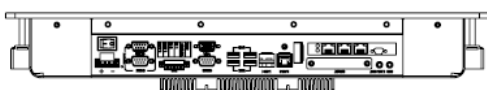
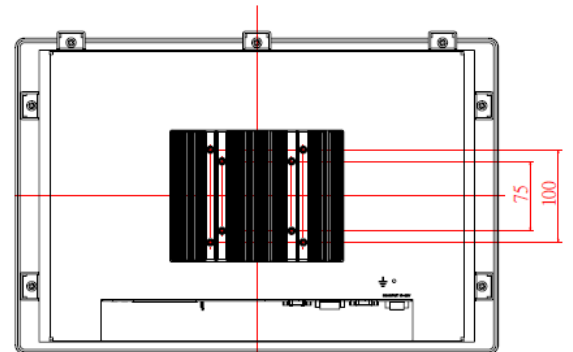
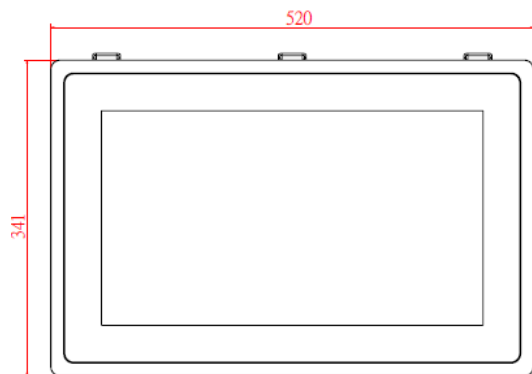
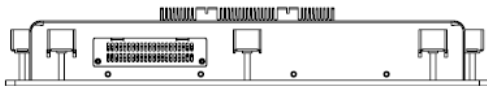

1.2.3 I/O View

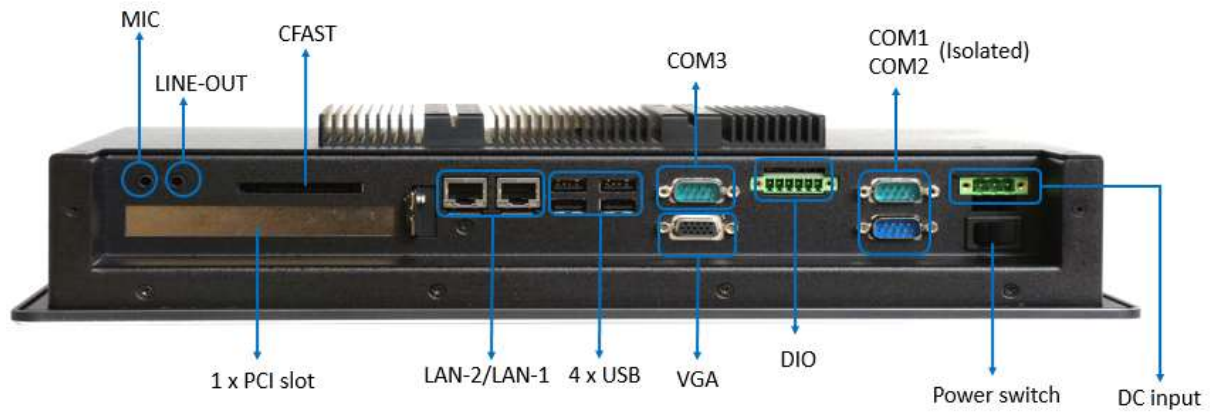

1.3 Accessory List

Part No.	Description	Quantity
1	3 pin Terminal Block for DC in	1 pc
2	6 pin Terminal Block for GPIO	1 pc
3	84W Adaptor (option)	1 pc
4	Power Cord (option)	1 pc

1.4 Installation

1.4.1 Installing HDD/SSD

1. Loosen the two screws as shown in the picture.



2. Loosen the two screws and pull out the HDD/SSD bracket.



3. Loosen the four screws and replace the HDD/SSD module.

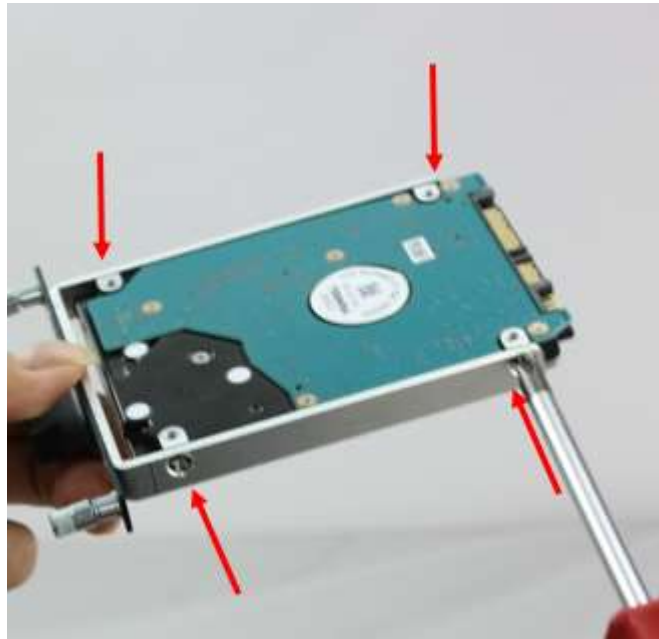

1.4.2 Installing CFAST

1. Loosen the two screws and replace the CFAST module.

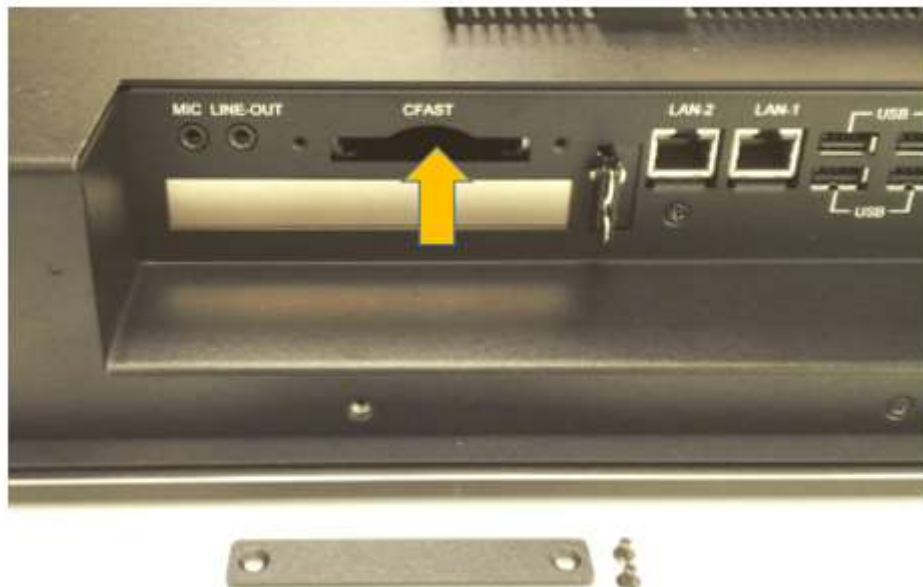
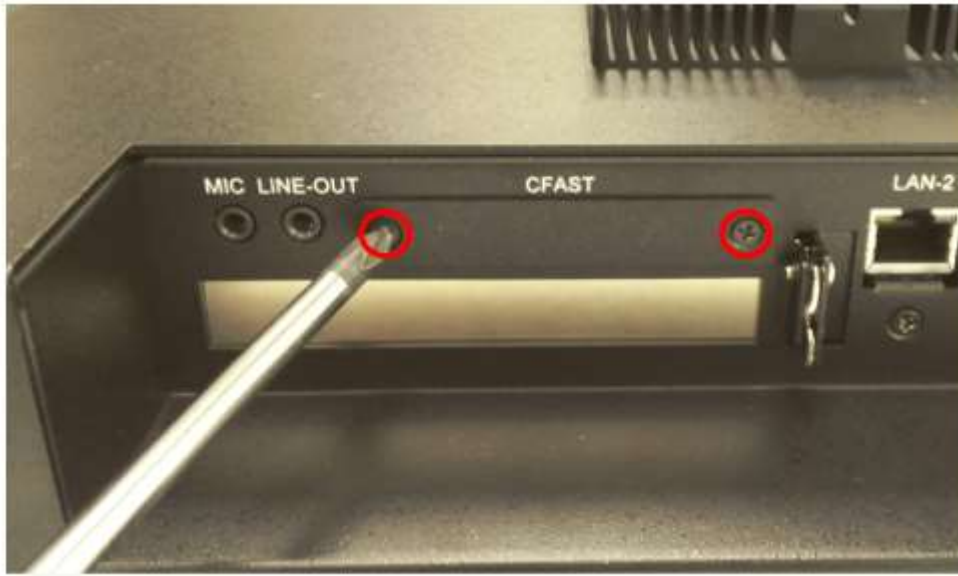

1.4.3 Installing additional PCI card

Note: 1. Please check with iBASE to know if the additional card can be installed in the product before you order.

2. We welcome you to ask iBASE to install the card for you. A reasonable charge may apply for the human resource cost involved.

1. Loosen 16 screws as picture.



2. Open the screen and pay attention to the internal cable as shown in the picture.



3. Unlock the three internal cables and remove the screen.
The connect location is shown in the picture.

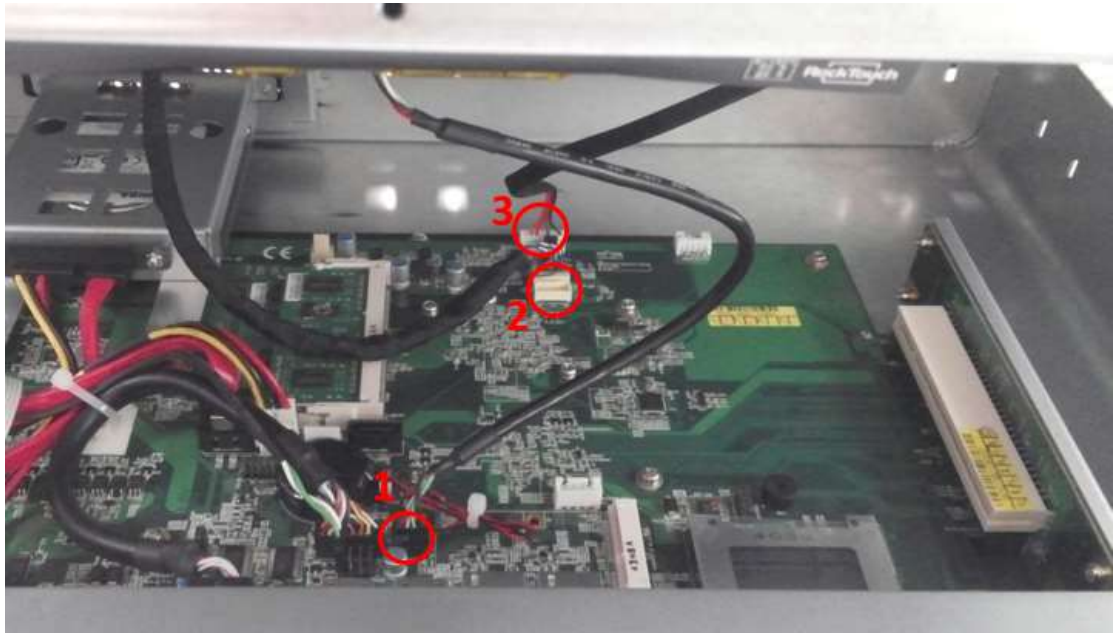

4. Loosen the two screws as shown and remove the two brackets.

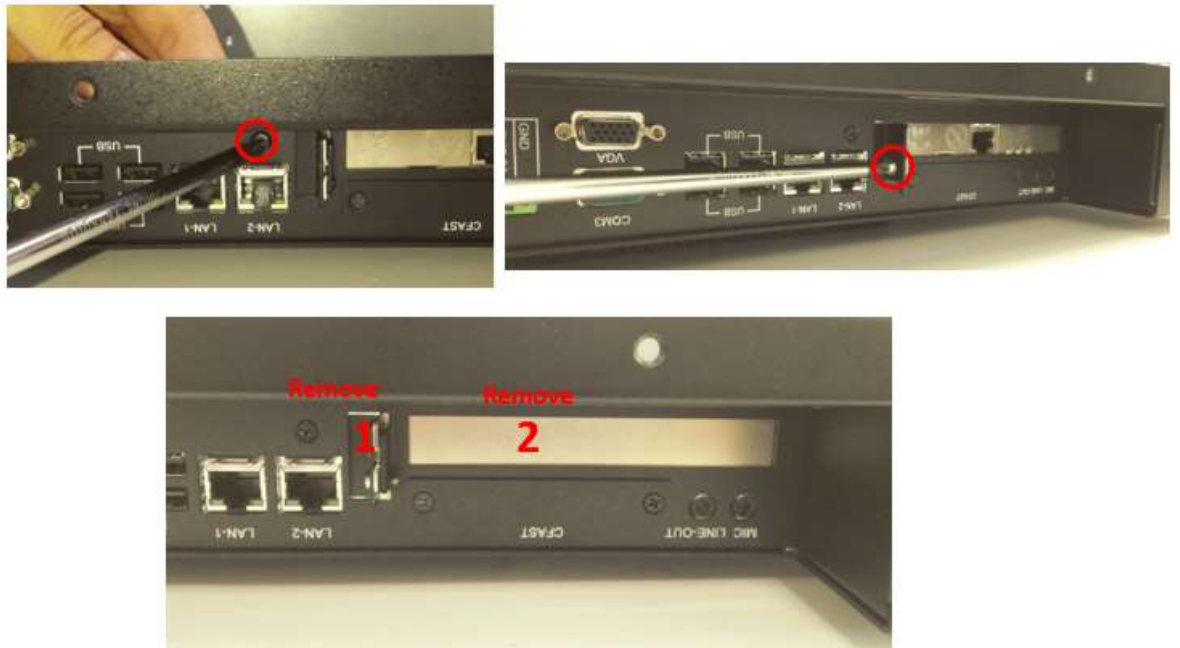

- Put the expansion card into the slot, as shown.

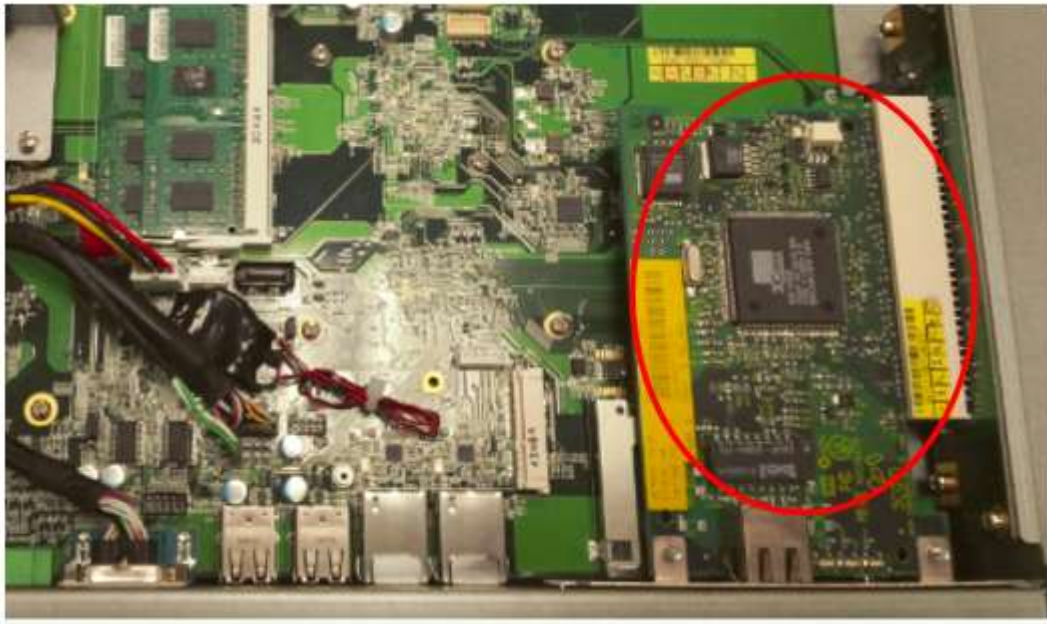

- Fix the black bracket and tighten the two screws as shown.



7. Connect the three internal cables and cover the screen.

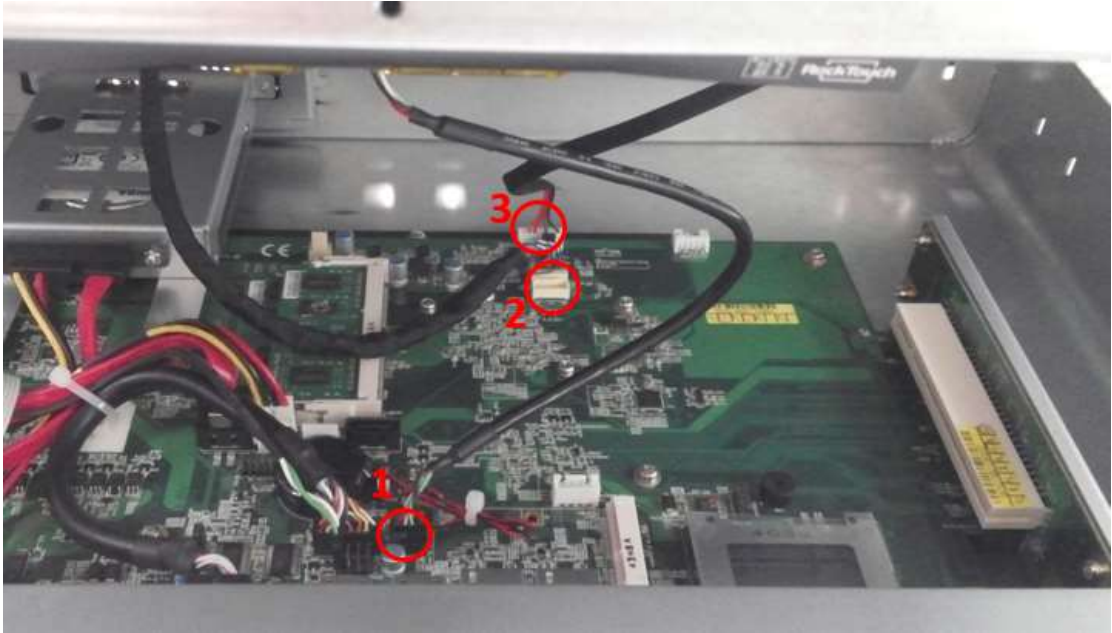

8. When done, tighten the 16 screws as shown.



CHAPTER 2 MOTHERBOARD INTRODUCTION

2.1 Introduction

The IB809 motherboard is based on the Intel® Atom Cedar Trail chipset. The Cedar Trail is a platform that uses the Intel Cedar Trail-D and Intel NM10 Express Chipset family.

The role of the processor in the system is to manage the flow of information between the following interfaces: DDR3 System Memory interface, VGA graphics interface and the Direct Media Interface (DMI). The processor supports single channel, two DDR3 SODIMMs.

The Intel® processors provide advanced performance in both computing and graphics quality. It is built on 32-nanometer Hi-K process technology with Micro-FCBGA11 packaging.

Specifications – Mainboard	
Product Name	IB809
Form Factor	Customized
CPU Type	Intel® Cedar View Processor, Atom D2550 2 core 10w TDP Package = FCBGA Type[22 mm x 22 mm]
CPU Speed	1.86GHz
Cache	1MB L2
CPU Socket	Package = FCBGA Type[22 mm x 22 mm]
Chipset	Intel® “Tiger Point” NM10 PCH, CG82NM10 [TDP = 2.1W, 130nm] Package = BGA360, 17mm x 17 mm
BIOS	AMI BIOS, support ACPI Function
Memory	Intel® Atom™ on-die memory controller; up to 4GB/2GB per slot Two DDR3-1066 SO-DIMM socket [Horizontal type], Non-ECC, Unbuffered, 1.5V
LVDS	2 x DF13 20p 24-bit Single/Dual channels LVDS interface via NXP PTN3460 from eDP
Graph	VGA x 1
LAN	2x Realtek 8111G as 1 st LAN and 2 nd LAN
USB	Intel® NM10 PCH integrated USB 2.0 host controller: 4 USB 2.0 type A ports in the rear side 1 port for onboard MiniPCIe 2 ports via pin header 1 port for Touch
Serial ATA Ports	Intel® NM10 PCH built-in SATA controller, Supports 2 x SATAII
Audio	Intel® NM10 PCH built-in HD Audio controller + Realtek ALC269Q-VC2-GR Codec w/class-D speaker amplifier (2W per channel @ 5V power supply) support 2-channel audio out + amp

LPC I/O	F81866AD-I (128-pin LQFP [14mm x 14 mm]) COM #1 (RS232/422/485) RS-485 with AFC COM #2 (RS232/422/485) RS-485 with AFC COM #3 (RS232 only, supports ring-in with power @500 mA, z jumper selectable for 5V or 12V) COM #4 (RS232 only) pin header COM #5 (RS-232 for touch) [Hardware Monitor] 2 x Thermal inputs 2 x Voltage monitoring 1 x Smart fan DC mode
Digital IO	4 GPIO (2in/2out), 1 x 5V Vcc and 1 Ground [thru edge connector @ 1x6 pins Terminal block type], not TTL with circuit protection 5V Vcc has count-current protection 4 GPIO(2in/2out) and Ground (header), not TTL with circuit protection
Expansion Slots	1 x Mini PCI-e socket x 1, <i>Full/Half-sized</i> type 1 x CFast
Edge Connector	GPIO (2in/2out)/VCC/Ground 1x6 pins terminal block RJ45 x 2 for GbE LAN, 2 connector for 2 port DB9 x 1 for COM1 (isolated) DB9 x 1 for COM3 USB 2.0 connector x 4 for USB1~4, 2 connectors for 4 ports 3 pins terminal block (+/G/-) for power input Line out microjack x 1 Mic-in microjack x 1 CFast socket x 1 Power LED SMD type, power on is green else no light
On Board Headers/ Connectors	2 ports x SATA II, SATA #2 shared CFast via NXP CBTL02043ABQ switch 4 pins power connector x 2 for SATA HDD 1 x DF-11 10 pin header for COM2 1 x DF-11 10 pin heard for COM4 1 x DF-11 10 pin header for VGA 1x8 pins DF-11 header x 1 for 2 ports USB 2.0 2x DF20G-20DP connector for 24-bit Single/Dual channel LVDS 2x5 pins headers x 1 for LPC (Debug purpose only) Mini PCI-e(1x) connector x 1 [Full/Half-sized] 1 x 5 2.0mm pins box header connector for 5 wire touch 1 x 4 2.5mm pins connector for L&R speaker out 1 x 7 pins box header for LCD backlight control 12V(1.5A)/12V(1.5A)/PWM/Backlight0~5V(500mA)/3.3V(500mA)/GN/GN) 1 x 5 pins box header for smart battery (RST/EXTSMI/Ground/DATA/CLK) 1 x 5 pins box header for GPIO, 2in/2out/Ground, not TTL 1 x 2 pins connector for RTC battery 1 x 3 pins connector for system smart fan DC type 1 x 8 pins header for Power on-off/reset/Power LED/HDD LED
Watchdog Timer	Yes (256 segments, 0, 1, 2...255 sec/min)
Power Connector	+12V(-10%)~+36V(+5%) DC-input
RoHS	Yes
Board Size	Customized
Golden Finger	PCIe x 16 golden finger for PCI (124P) and PCIe x1 (36P) signal
Touch controller	Onboard Penmount 6000 USB/RS-232 selectable by jumper, default RS-232
Others	CPU & NM10 PCH are located at back side No chemical capacitor on board -20~60°C Operating temperature

Board Dimensions

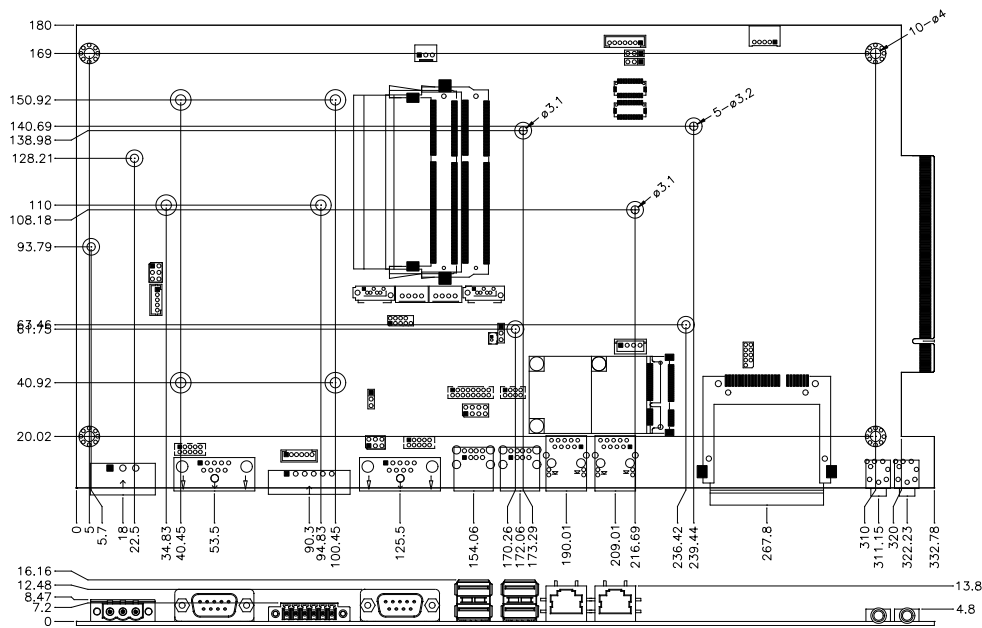

The IB809 board supports two DDR3 memory socket for a maximum total memory of 4GB in DDR3 memory type.

Installing and Removing Memory Modules

To install the DDR3 modules, locate the memory slot on the board and perform the following steps:

1. Hold the DDR3 module so that the key of the DDR3 module aligned with that on the memory slot.
2. Gently push the DDR3 module in an upright position until the clips of the slot close to hold the DDR3 module in place when the DDR3 module touches the bottom of the slot.
3. To remove the DDR3 module, press the clips with both hands.

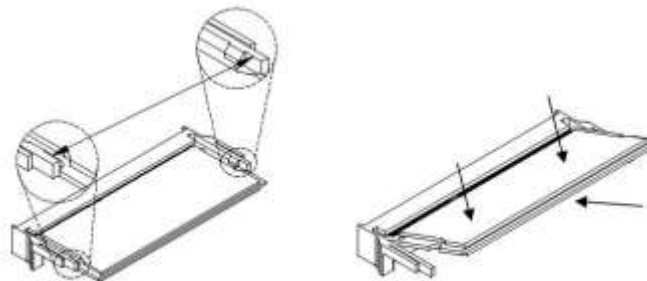

**** DIMM1 slot must be installed with memory module for booting up****

2.2 Setting Jumpers

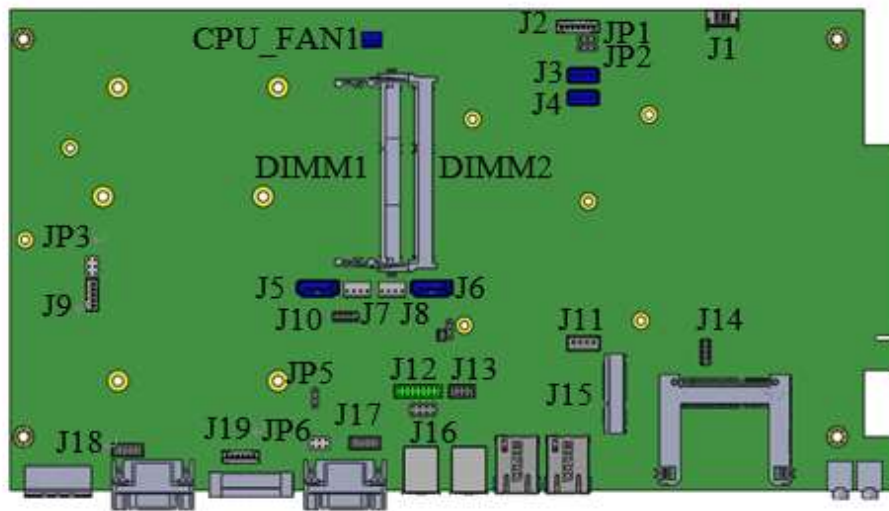

Jumpers are used on IB809 to select various settings and features according to your needs and applications. Contact your supplier if you have doubts about the best configuration for your needs. The following lists the connectors on IB809 and their respective functions.

Jumper Locations on IB809



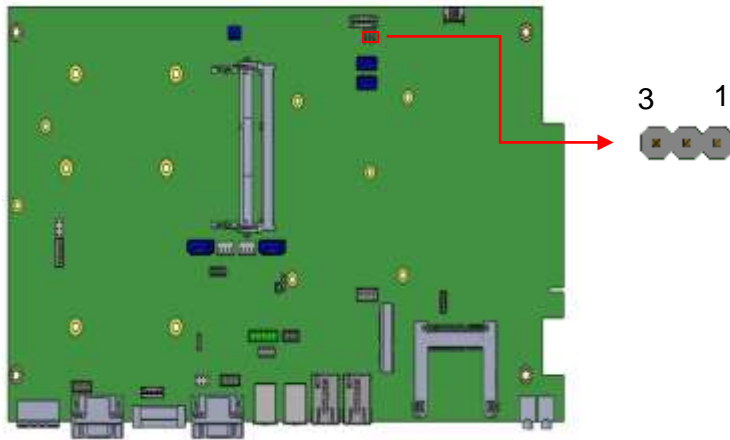

JP1: LCD Panel Power Selection

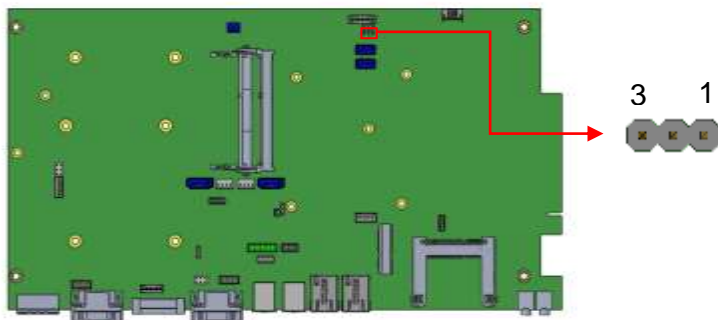

JP1	Setting	LCD Panel Power
	Pin 1-2 Short/Closed	+3.3V*
	Pin 2-3 Short/Closed	+5V

JP2: LCD BackLight Control Output Level



JP2	Setting	Level
	Pin 1-2 Short/Closed	+3.3V*
	Pin 2-3 Short/Closed	+5V

JP3: Touch USB/UART Mode Setting

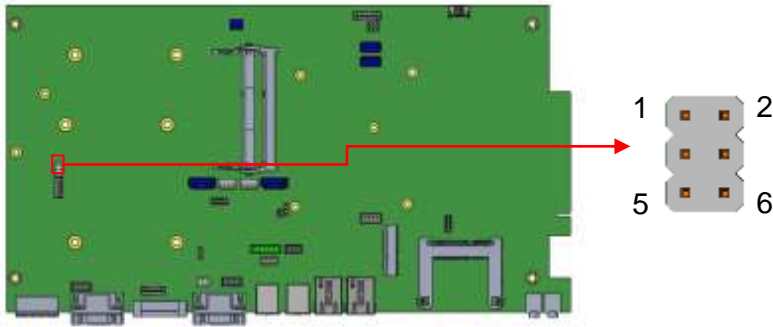

JP3	USB Setting*	Function
	Pin 1-3 Short/Closed	USB
	Pin 2-4 Short/Closed	
JP3	UART Setting	Function
	Pin 3-5 Short/Closed	UART*
	Pin 2-4 Short/Closed	Baud rate 19200*
	Pin 4-6 Short/Closed	Baud rate 9600

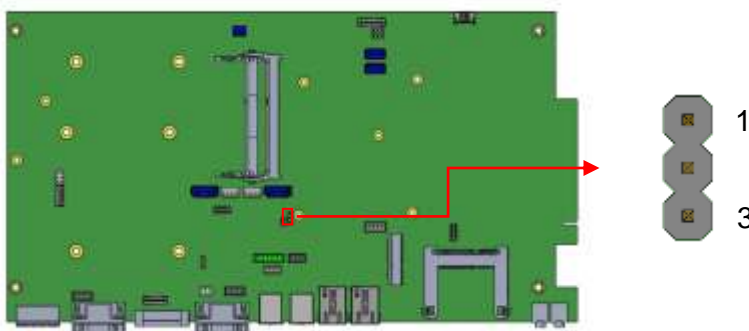

JP4: Clear CMOS Setting

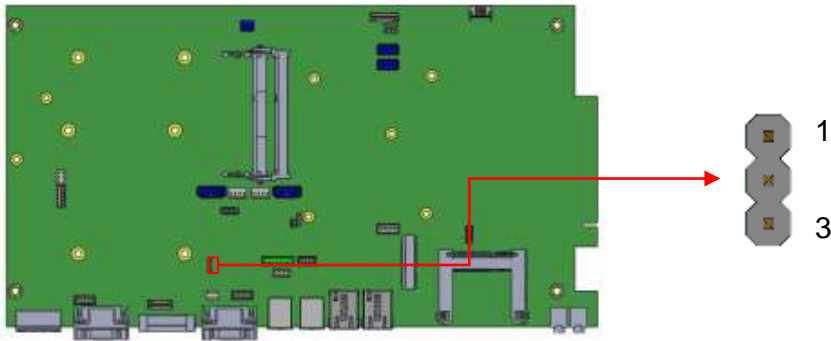

JP4	Setting	Function
	Pin 1-2 Short/Closed	Normal*
	Pin 2-3 Short/Closed	Clear CMOS

JP5: AT/ATX Mode Selection



JP5	Setting	Setting
	Pin 1-2 Short/Closed	AT*
	Pin 2-3 Short/Closed	ATX

JP6: COM3 RS232 RI/+5V/+12V Setting

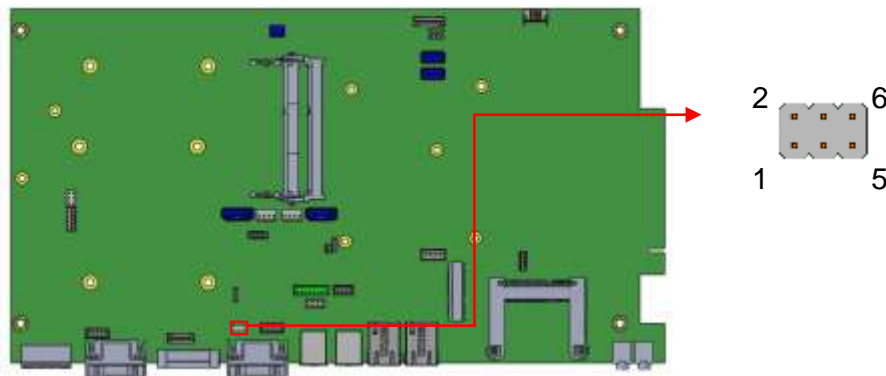

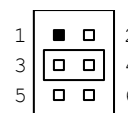
JP6	Setting	Function
	Pin 1-3 Short/Closed	+12V
	Pin 3-4 Short/Closed	RI*
	Pin 3-5 Short/Closed	+5V

Note: The suggested setting is RI, with Max. current lower than 0.5A.

Connector Locations on IB809

Top Side

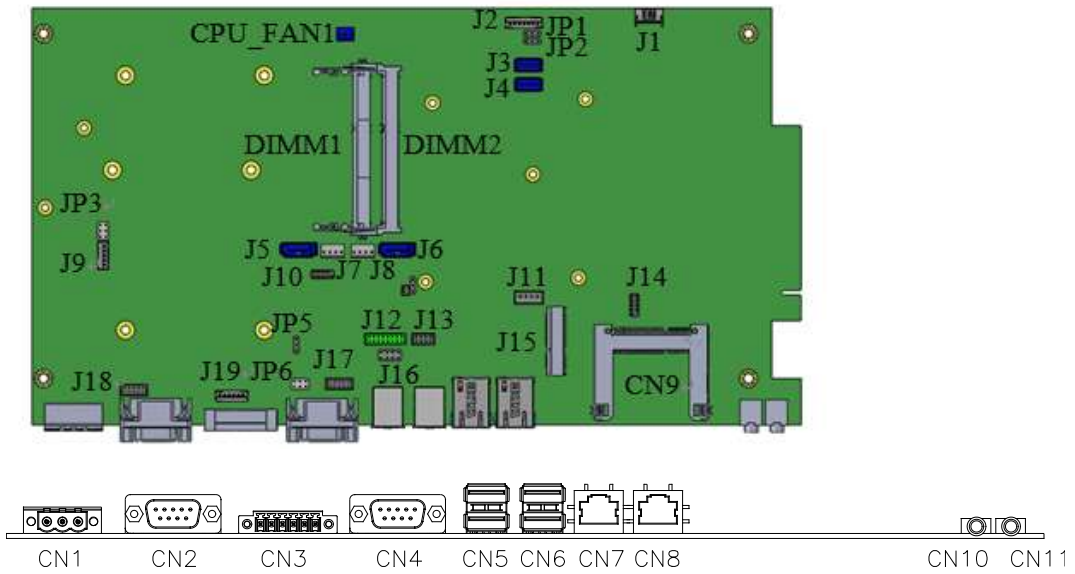

Bottom Side

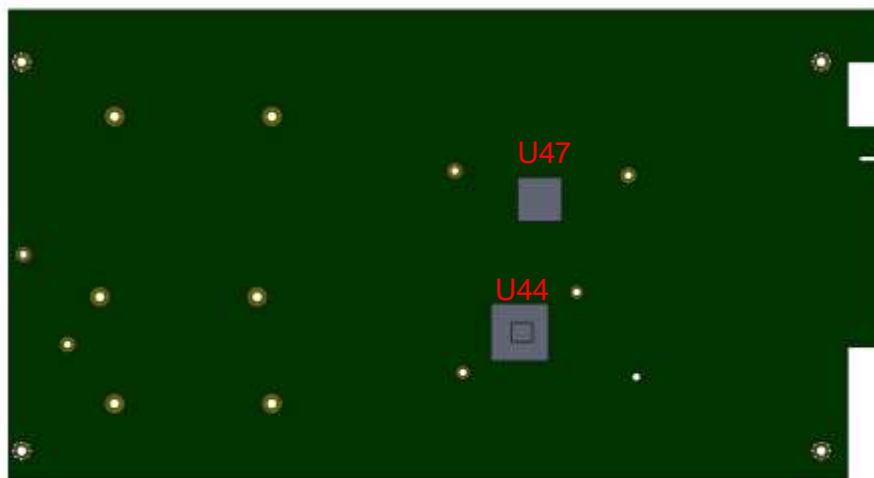

CN1: DC-IN +12~36V Connector

1X3_5.0mm_Male_Terminal (DINKLE 5EHDRM-03P)

Mating: DINKLE 5ESDVM-03P

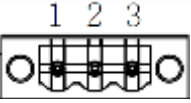
	Pin #	Signal Name
	1	+
	2	G
	3	-

CN2: Isolate COM1/RS232/422/485

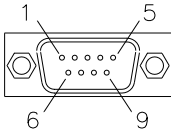
	Pin #	Signal Name		
		RS-232	RS-422	RS-485
	1	DCD	TX-	DATA-
	2	RX	TX+	DATA+
	3	TX	RX+	NC
	4	DTR	RX-	NC
	5	Ground	Ground	Ground
	6	DSR	NC	NC
	7	RTS	NC	NC
	8	CTS	NC	NC
	9	RI	NC	NC

CN3: Digital I/O

1X6_3.5mm_Male_Terminal (DINKLE ECH350RM-06P)

Mating: DINKLE EC350VM-06P

	Pin #	Signal Name
	1	OUT0
	2	OUT1
	3	IN0
	4	IN1
	5	+5V/0.5A
	6	GND

CN4: COM3 RS232 Serial Port

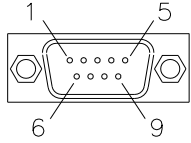
	Pin #	Signal Name
	1	DCD
	2	RX
	3	TX
	4	DTR
	5	Ground
	6	DSR
	7	RTS
	8	CTS
	9	RI*/+5V/+12V

Note: Pin 9 supports RI/+5V/+12V function set by JP6.

CN5, CN6: USB2.0 Connectors

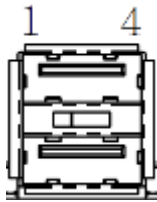
	Pin #	Signal Name
	1	VCC
	2	DATA-
	3	DATA+
	4	Ground

CN7, CN8: Gigabit LAN Connectors (Realtek RTL8111G-CG)

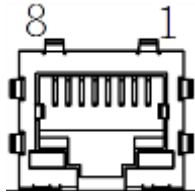
	Pin #	Signal Name
	1	MDI0+
	2	MDI0-
	3	MDI1+
	4	MDI1-
	5	MDI2+
	6	MDI2-
	7	MDI3+
8	MDI3-	

CN9: CFAST Connector

Remarks: Signal is shared with SATA connector (J6)

CN10: HD Audio Line-out Connector

CN11: HD Audio Microphone Connector

CPU_FAN1: CPU Fan1 Power Connector

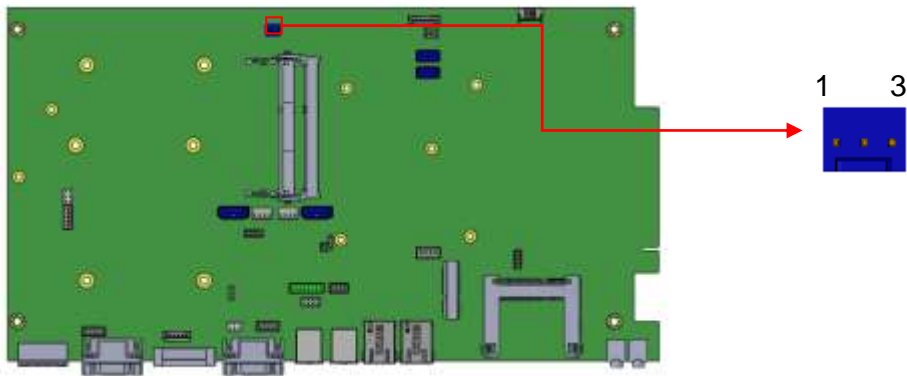

	Pin #	Signal Name
	1	Ground
	2	+12V/0.5A
	3	Rotation detection

Note: CPU_FAN1 for DC FAN mode

DIMM1, DIMM2: DDR3 SO-DIMM Socket

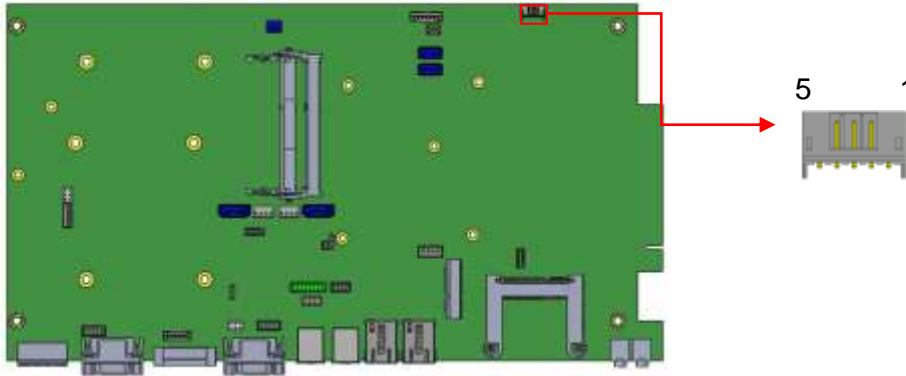
J1: Smart Battery Connector

1X5_2.0mm_Right Angle_Male (E-CALL 0110-162-050 compatible JST S5B-PH-K-S)

Mating connector: JST PHR-5

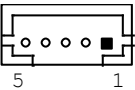
	Pin #	Signal Name
	1	Reset#
	2	SMI#
	3	Ground
	4	SMB_DATA
	5	SMB_CLOCK

J2: LCD Backlight Connector

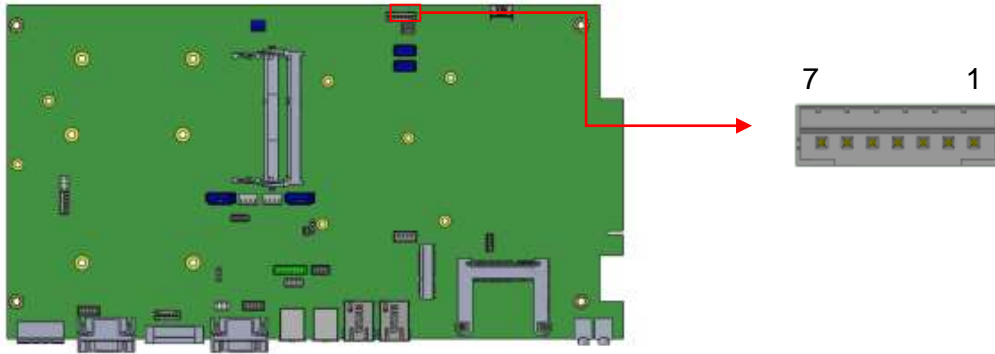

1X7_2.0mm_Straight_Male (E-CALL 0110-161-070 compatible JST B7B-PH-K-S)

Mating connector: JST PHR-7

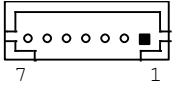
	Pin #	Signal Name
	1	+12V/1.5A
	2	+12V/1.5A
	3	Ground
	4	Ground
	5	Backlight Enable
	6	Brightness Control
	7	+3.3V/0.5A

J3: LVDS Connector (1st channel)

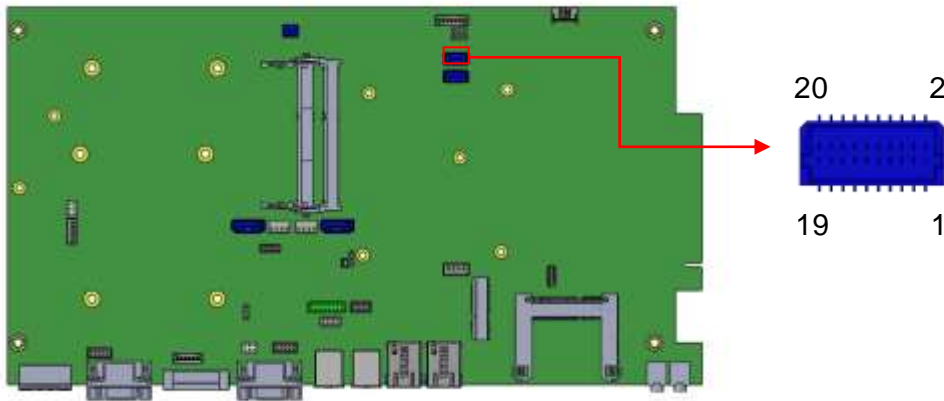

LVDS Connectors: 2X10_1.0mm_Straight_Male_DF20 (Hirose DF20G-20DP-1V (56))

Mating connector: DF20A-20DS-1C

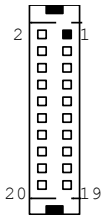
	Signal Name	Pin #	Pin #	Signal Name
 <p>DF20G</p>	LVSAO_N	2	1	LVSAO_P
	Ground	4	3	Ground
	LVSBO_N	6	5	LVSBO_P
	Ground	8	7	Ground
	LVSCO_N	10	9	LVSCO_P
	Ground	12	11	Ground
	LVSCKO_N	14	13	LVSCKO_P
	Ground	16	15	Ground
	LVSDO_N	18	17	LVSDO_P
	+5V/3.3V*	20	19	+5V/3.3V*

J4: LVDS Connector (2nd channel)

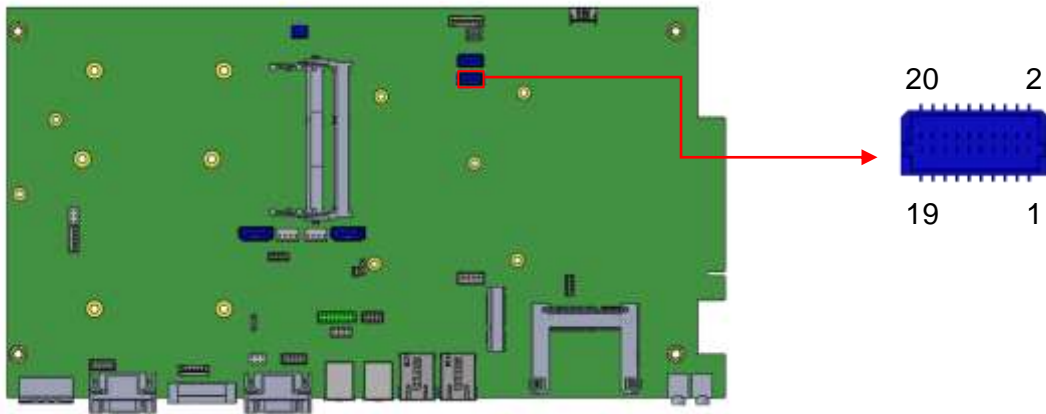

LVDS Connectors: 2X10_1.0mm_Straight_Male_DF20 (Hirose DF20G-20DP-1V (56))

Mating connector: DF20A-20DS-1C

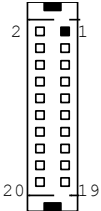
	Signal Name	Pin #	Pin #	Signal Name
 DF20G	LVS _{AE} _N	2	1	LVS _{AE} _P
	Ground	4	3	Ground
	LVS _{BE} _N	6	5	LVS _{BE} _P
	Ground	8	7	Ground
	LVS _{CE} _N	10	9	LVS _{CE} _P
	Ground	12	11	Ground
	LVS _{CKE} _N	14	13	LVS _{CKE} _P
	Ground	16	15	Ground
	LVS _{DE} _N	18	17	LVS _{DE} _P
	+5V/3.3V*	20	19	+5V/3.3V*

J5, J6: SATA Connectors

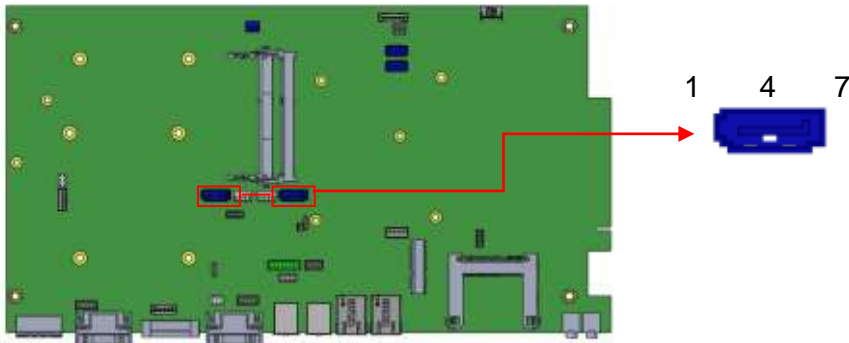

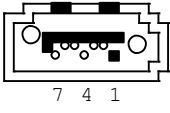
	Pin #	Signal Name
	1	Ground
	2	TX+
	3	TX-
	4	Ground
	5	RX-
	6	RX+
	7	Ground

Remarks: J6 signal is shared with CFAST connector (CN9)

J7, J8: HDD Power Connectors

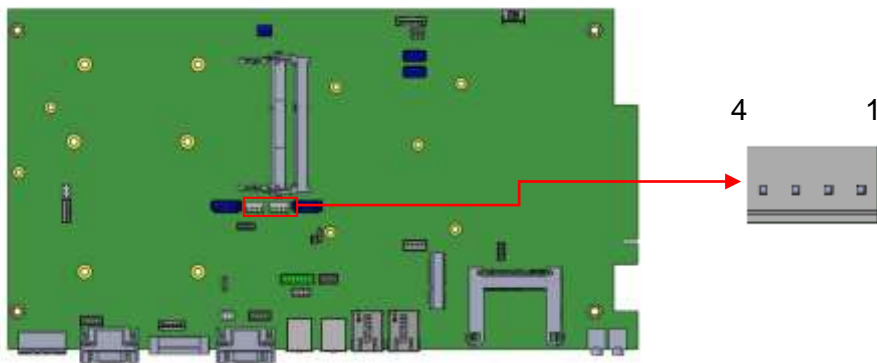

1X4_2.5mm_Straight_Male_Wafer (Haoguo W7-03H104142S1WT)

	Pin #	Signal Name
	1	+5V
	2	Ground
	3	Ground
4	+12V	

J9: 5-Wire Touch Panel Connector

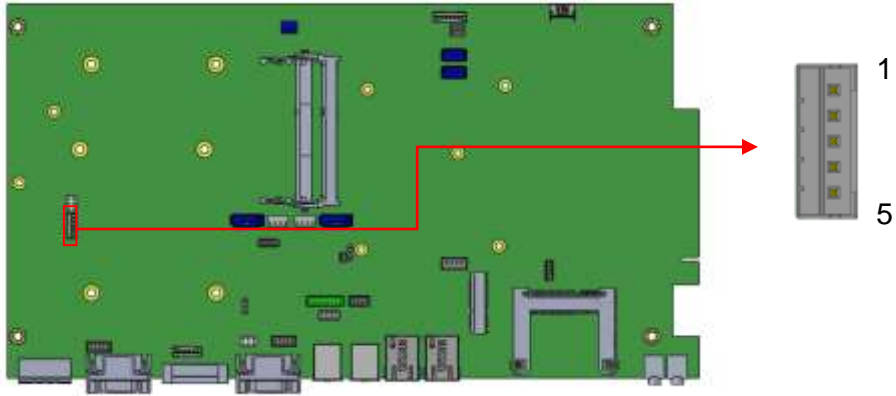

1X5_2.0mm_Straight_Male (E-CALL 0110-161-050 compatible JST B5B-PH-K-S)

Mating connector: JST PHR-5

	Pin #	Signal Name
	1	LR
	2	LL
	3	WIP
	4	UR
	5	UL

J10: Debug 80 Port Connector (factory use only)

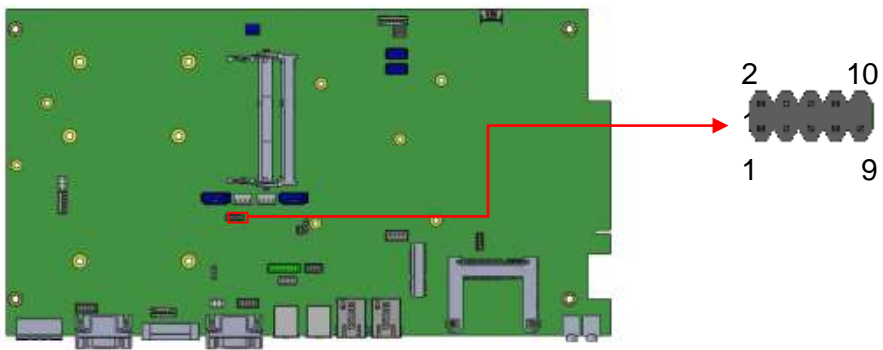

J11: Speaker Connector

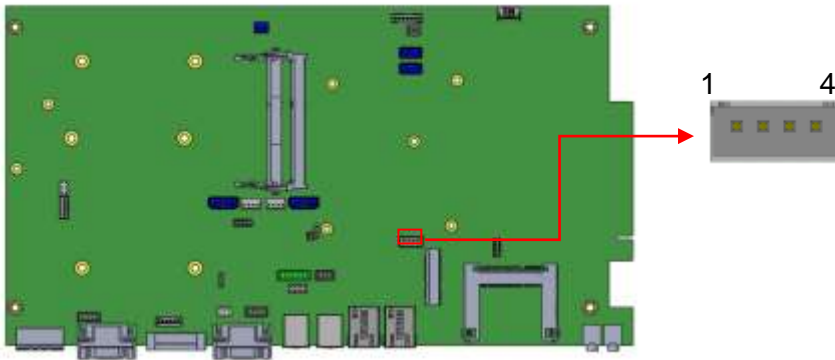

1X4_2.5mm_Straight_Male_Wafer (E-CALL 0110-071-040 compatible JST B4B-XH-A)
 Mating connector: JST XHP-4

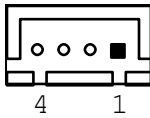

Pin #	Signal Name
1	Speaker-L+
2	Speaker-L-
3	Speaker-R-
4	Speaker-R+

J12: VGA Connector

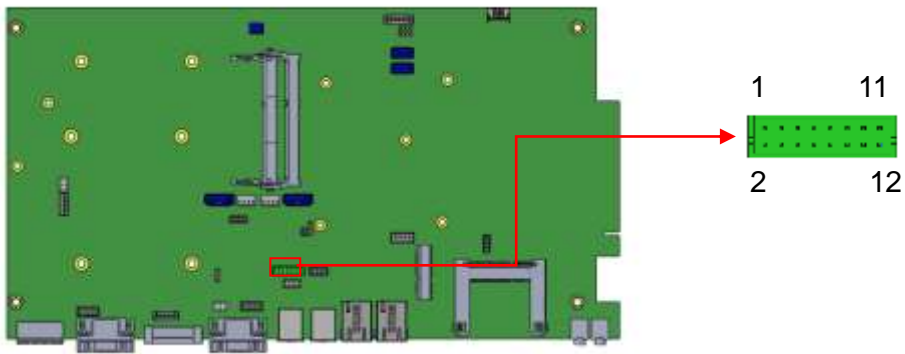

2X6_2.0mm_Straight_Male_DF11 (Haoguo DF11-12S-PA66H compatible Hirose DF11-16DP-2DSA(08))

Mating connector: Hirose DF11-12DS-2C

	Signal Name	Pin #	Pin #	Signal Name
	+5VS	2	1	Red
	Ground	4	3	Green
	N.C.	6	5	Blue
	DDC_DATA	8	7	N.C.
	HSYNC	10	9	Ground
	VSYNC	12	11	Ground
	DDC_CLK	14	13	Ground
	N.C.	16	15	Ground

J13: USB6/7 Ports Header

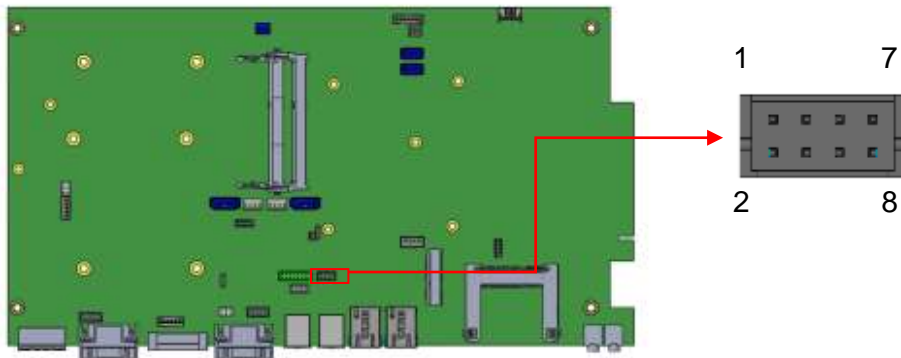

2X4_2.0mm_Straight_Male_DF11 (Haoguo DF11-8S-PA66H, compatible Hirose DF11-8DP-2DSA (08))

Mating connector: Hirose DF11-8DS-2C

	Signal Name	Pin #	Pin #	Signal Name
	+5V	1	2	Ground
	Data-	3	4	Data+
	Data+	5	6	Data-
	Ground	7	8	+5V

J14: SPI Flash Tool (Factory use only)

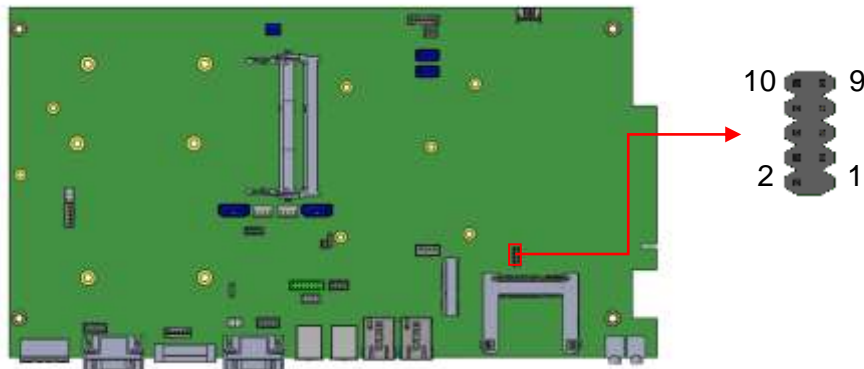

J15: Mini PCIE V1.2 Connector

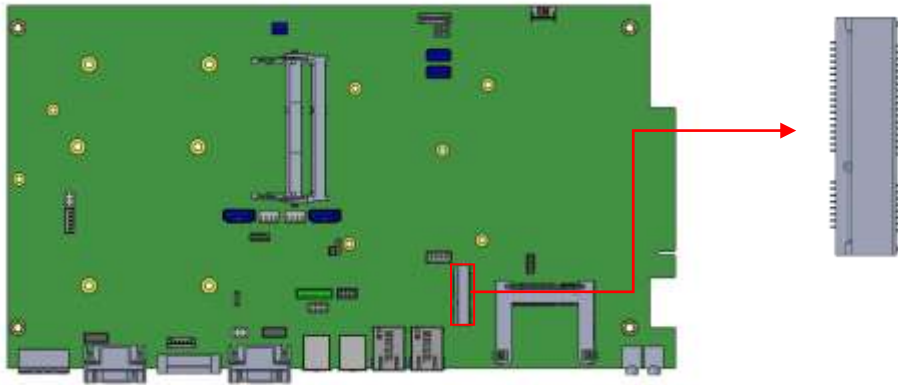

J16: System Function Connector

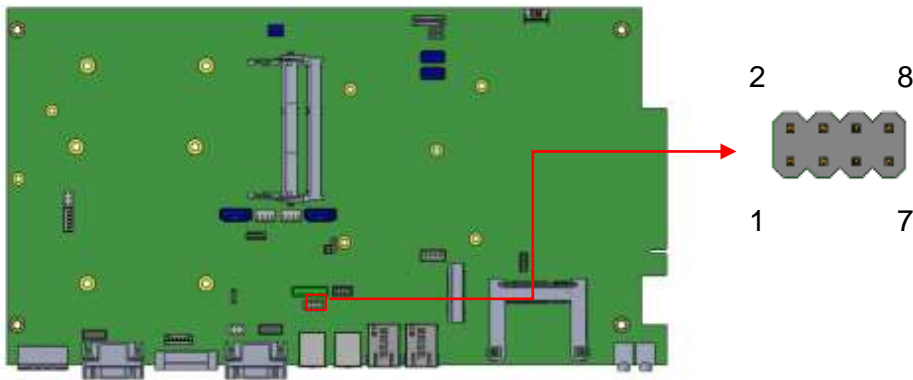

2X4_2.54mm_Straight_Male_Pin Header (E-CALL 0126-01-203-080)

	Signal Name	Pin #	Pin #	Signal Name
1	Power BTN	1	2	Power BTN
2				
3	Power LED+	3	4	Power LED-
4				
5	HDD LED+	5	6	HDD LED-
6				
7	Reset BTN	7	8	Reset BTN
8				

J17: COM4 RS232 Serial Port

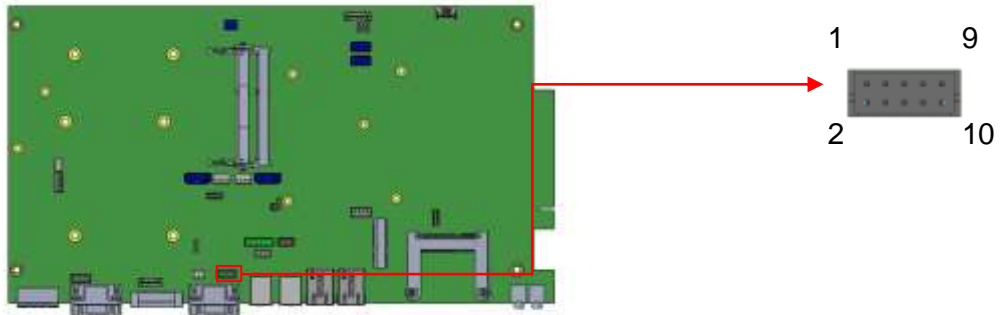

2X5_2.0mm_Straight_Male_DF11 (Haoguo DF11-10S-PA66H compatible Hirose DF11-10DP-2DSA (08))

Mating connector: Hirose DF11-10DS-2C

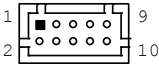
	Signal Name	Pin #	Pin #	Signal Name
	DCD	1	2	RXD
	TXD	3	4	DTR
	Ground	5	6	DSR
	RTS	7	8	CTS
	RI	9	10	N.C.

J18: Isolate COM2 RS232/422/485

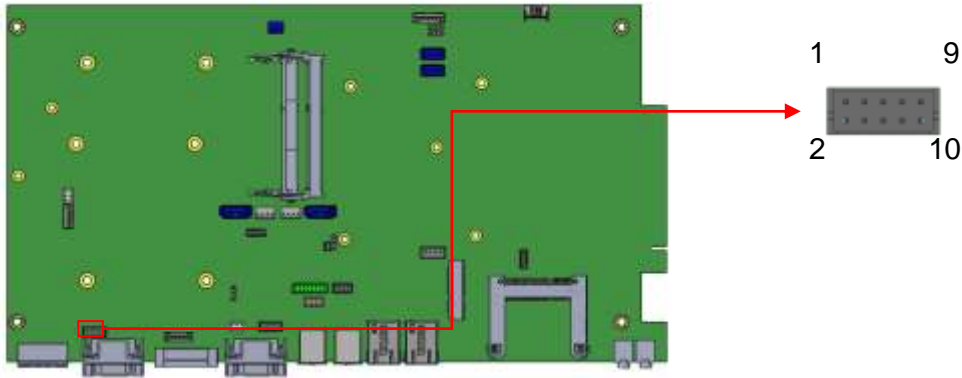

2X5_2.0mm_Straight_Male_DF11 (Haoguo DF11-10S-PA66H compatible Hirose DF11-10DP-2DSA (08))

Mating connector: Hirose DF11-10DS-2C

	Pin #	Signal Name		
		RS-232	RS-422	RS-485
	1	DCD	TX-	DATA-
	2	RX	TX+	DATA+
	3	TX	RX+	NC
	4	DTR	RX-	NC
	5	Ground	Ground	Ground
	6	DSR	NC	NC
	7	RTS	NC	NC
	8	CTS	NC	NC
	9	RI	NC	NC
	10	NC	NC	NC

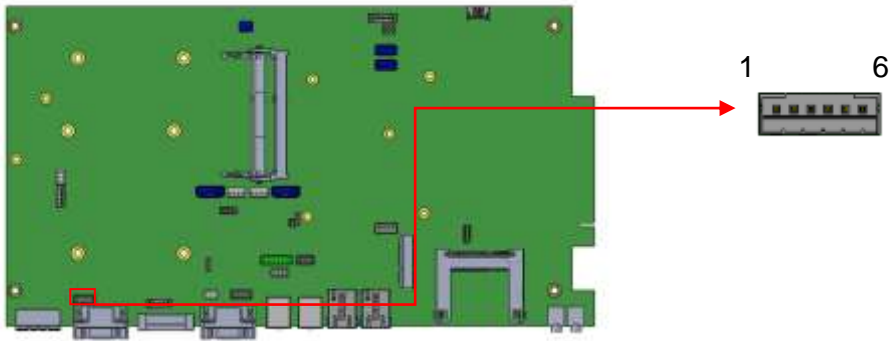
J19: Digital I/O

1X5_2.0mm_Straight_Male (E-CALL_0110-161-060 compatible JST B6B-PH-K-S)

Mating connector: JST PHR-6

	Pin #	Signal Name
	1	OUT2
	2	OUT3
	3	IN2
	4	IN3
	5	+5V/0.5A
	6	GND

LED2: POWER LED (Green)

CHAPTER 3 BIOS SETUP

3.1 BIOS Introduction

The BIOS (Basic Input/Output System) installed in your computer system's ROM supports Intel processors. The BIOS provides critical low-level support for a standard device such as disk drives, serial ports and parallel ports. It also password protection as well as special support for detailed fine-tuning of the chipset controlling the entire system.

3.2 BIOS Setup

The BIOS provides a Setup utility program for specifying the system configurations and settings. The BIOS ROM of the system stores the Setup utility. When you turn on the computer, the BIOS is immediately activated. Pressing the key immediately allows you to enter the Setup utility. If you are a little bit late pressing the key, POST (Power On Self Test) will continue with its test routines, thus preventing you from invoking the Setup. If you still wish to enter Setup, restart the system by pressing the "Reset" button or simultaneously pressing the <Ctrl>, <Alt> and <Delete> keys. You can also restart by turning the system Off and back On again. The following message will appear on the screen:

```
Press <DEL> to Enter Setup
```

In general, you press the arrow keys to highlight items, <Enter> to select, the <PgUp> and <PgDn> keys to change entries, <F1> for help and <Esc> to quit.

When you enter the Setup utility, the Main Menu screen will appear on the screen. The Main Menu allows you to select from various setup functions and exit choices.

Warning: *It is strongly recommended that you avoid making any changes to the chipset defaults. These defaults have been carefully chosen by both AMI and your system manufacturer to provide the absolute maximum performance and reliability. Changing the defaults could cause the system to become unstable and crash in some cases.*

3.3 Advanced Settings

This section allows you to configure and improve your system and allows you to set up some system features according to your preference.

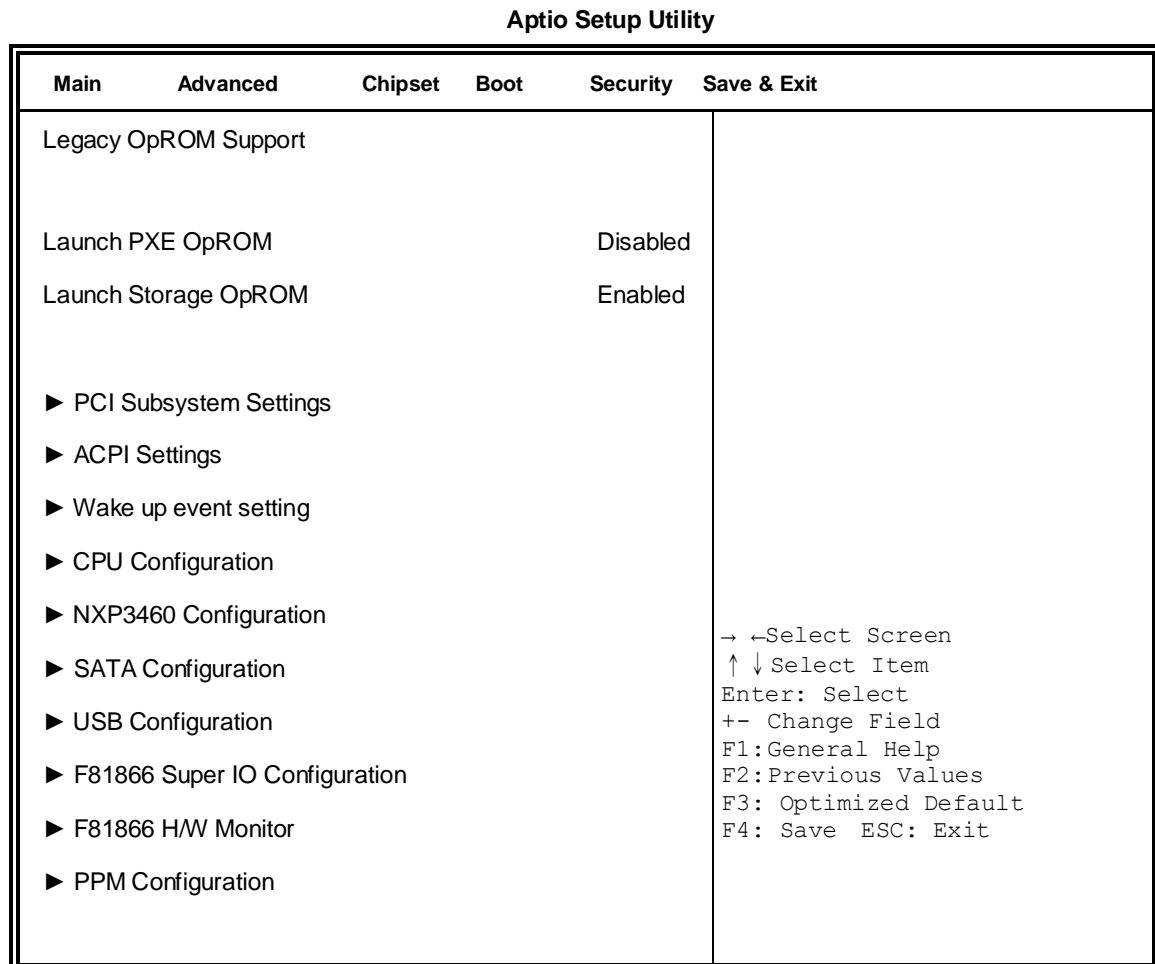

Launch PXE OpROM

Enable or Disable Boot Option for Legacy Network Devices.

Launch Storage OpROM

Enable or Disable Boot Option for Legacy Mass Storage Devices with Option ROM.

PCI Subsystem Settings

Aptio Setup Utility

Main	Advanced	Chipset	Boot	Security	Save & Exit
PCI Bus Driver Version				V 2.05.01	
PCI ROM Priority			Legacy ROM		
PCI Common Settings					
PCI Latency Timer			32 PCI Bus Clocks		
VGA Palette Snoop			Disabled		
PERR# Generation			Disabled		
SERR# Generation			Disabled		

→ ← Select Screen
 ↑ ↓ Select Item
 Enter: Select
 +- Change Field
 F1: General Help
 F2: Previous Values
 F3: Optimized Default
 F4: Save ESC: Exit

PCI ROM Priority

In case of multiple Option ROMs (Legacy and EFI Compatible), specifies what PCI Option ROM to launch.

PCI Latency Timer

Value to be programmed into PCI Latency Timer Register.

VGA Palette Snoop

Enables or Disables VGA Palette Registers Snooping.

PERR# Generation

Enables or Disables PCI Device to Generate PERR#.

SERR# Generation

Enables or Disables PCI Device to Generate SERR#.

ACPI Settings

Aptio Setup Utility

Main	Advanced	Chipset	Boot	Security	Save & Exit
Enable ACPI Auto Configuration				Disabled	
Enable Hibernation			Enabled		
ACPI Sleep State			S1 (CPU Stop Clock)		
S3 Video Report			Disabled		

→ ← Select Screen
 ↑ ↓ Select Item
 Enter: Select
 +- Change Field
 F1: General Help
 F2: Previous Values
 F3: Optimized Default
 F4: Save ESC: Exit

Enabled ACPI Auto Configuration

Enables or Disables BIOS ACPI Auto Configuration.

Enable Hibernation

Enables or Disables System ability to Hibernate (OS/S4 Sleep State). This option may be not effective with some OS.

ACPI Sleep State

Select the highest ACPI sleep state the system will enter, when the SUSPEND button is pressed.

S3 Video Report

The default setting is Disabled.

Wake up event settings

Aptio Setup Utility

Main	Advanced	Chipset	Boot	Security	Save & Exit
Wake system with Fixed Time				Disabled	
Wake up hour		0			
Wake up minute		0			
Wake up second		0			
Wake up by Ring			Disabled		
Wake up by PCIE WAKE#			Disabled		
					→ ←Select Screen ↑ ↓Select Item Enter: Select +- Change Field F1:General Help F2:Previous Values F3: Optimized Default F4: Save ESC: Exit

Wake system with Fixed Time

Enables or Disables System wake on alarm event. When enabled, System will wake on the hr::min:: sec specified.

Wake on Ring

The options are Disabled and Enabled.

Wake on PCIE PME

The options are Disabled and Enabled.

Remarks: If Wake on LAN is to be supported, this option should be enabled.

CPU Configuration

This section shows the CPU configuration parameters.

Aptio Setup Utility

Main	Advanced	Chipset	Boot	Security	Save & Exit
CPU Configuration					
Processor Type			Intel(R) Atom(TM) CPU		
EMT64			Supported		
Processor Speed			1865 MHz		
System Bus Speed			533 MHz		
Ratio Status			14		
Actual Ratio			14		
System Bus Speed			533 MHz		
Processor Stepping			30661		
Microcode Revision			269		
L1 Cache RAM			2x56 k		
L2 Cache RAM			2x512 k		
Processor Core			Dual		
Hyper-Threading			Supported		
Hyper-Threading			Enabled		
Execute Disable Bit			Enabled		
					→ ←Select Screen ↑ ↓Select Item Enter: Select +- Change Field F1:General Help F2:Previous Values F3: Optimized Default F4: Save ESC: Exit

Hyper-threading

Enabled for Windows XP and Linux (OS optimized for Hyper-Threading Technology) and Disabled for other OS (OS not optimized for Hyper-Threading Technology). When Disabled, only one thread per enabled core is enabled.

Execute Disable Bit

XD can prevent certain classes of malicious buffer overflow attacks when combined with a supporting OS (Windows Server 2003 SP1, Windows XP SP2, SuSE Linux 9.2, Re33dHat Enterprise 3 Update 3.)

NXP3460 Configuration

Aptio Setup Utility

Main	Advanced	Chipset	Boot	Security	Save & Exit
NXP3460 Configuration					
LCD Protocol		24bit(VESA), Single...			→ ←Select Screen ↑ ↓Select Item Enter: Select +- Change Field F1:General Help F2:Previous Values F3: Optimized Default F4: Save ESC: Exit
Panel Type		1024 x 768			

SATA Configuration

Aptio Setup Utility

Main	Advanced	Chipset	Boot	Security	Save & Exit
SATA Port0		Not Present			→ ←Select Screen ↑ ↓Select Item Enter: Select +- Change Field F1:General Help F2:Previous Values F3: Optimized Default F4: Save ESC: Exit
SATA Port1		Not Present			
SATA Controller(s)		Enabled			
Configure SATA as		IDE			

SATA Controller(s)

Enable / Disable Serial ATA Controller.

Configure SATA as

- (1) IDE Mode.
- (2) AHCI Mode.

USB Configuration

Aptio Setup Utility

Main	Advanced	Chipset	Boot	Security	Save & Exit
USB Configuration					
USB Devices:					
None					
Legacy USB Support			Enabled		
EHCI Hand-off			Enabled		
USB hardware delays and time-outs:					→ ← Select Screen ↑ ↓ Select Item Enter: Select +- Change Field F1: General Help F2: Previous Values F3: Optimized Default F4: Save ESC: Exit
USB Transfer time-out			20 sec		
Device reset time-out			20 sec		
Device power-up delay			AUTO		

Legacy USB Support

Enables Legacy USB support.

AUTO option disables legacy support if no USB devices are connected.

DISABLE option will keep USB devices available only for EFI applications.

EHCI Hand-off

Enabled/Disabled. This is a workaround for OSes without EHCI hand-off support. The EHCI ownership change should be claimed by EHCI driver.

USB Transfer time-out

The time-out value for Control, Bulk, and Interrupt transfers.

Device reset time-out

USB mass Storage device start Unit command time-out.

Device power-up delay

Maximum time the device will take before it properly reports itself to the Host Controller. 'Auto' uses default value: for a Root port it is 100ms, for a Hub port the delay is taken from Hub descriptor.

F81866 Super IO Configuration

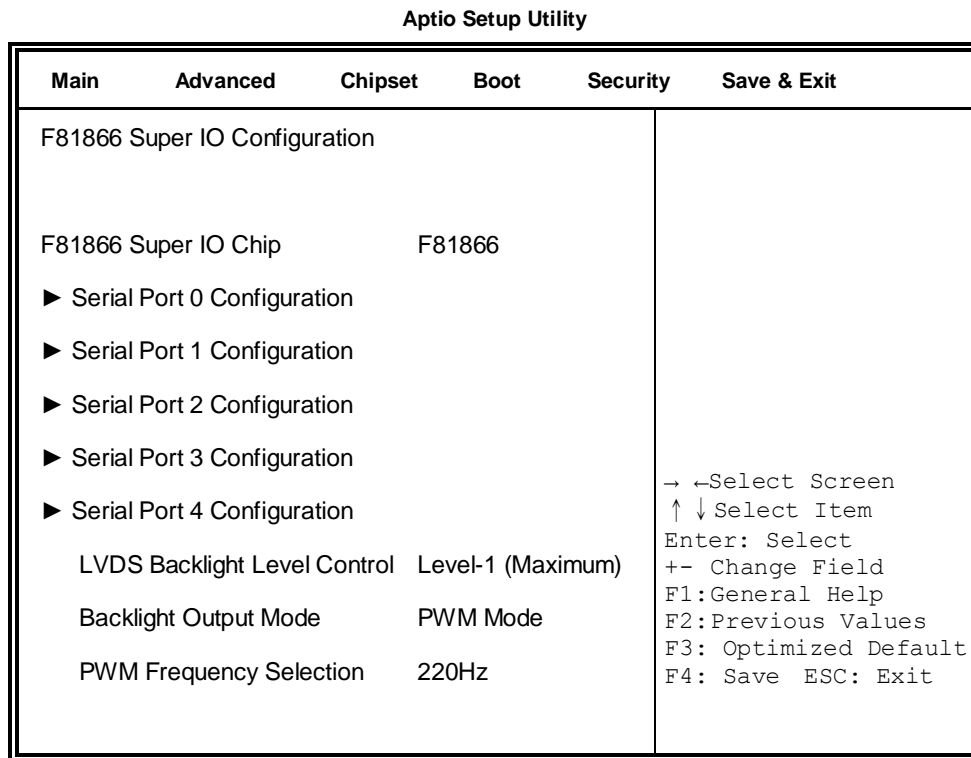

F81866 Serial Port Configuration

Set Parameters of Serial Ports. User can Enable/Disable the serial port and Select an optimal settings for the Super IO Device.

LVDS Backlight Level Control

The options are : Level-1 (Maximum) , Level-2 , Level-3 , Level-4 , Level-5 , Level-6 , Level-7 , Level-8 (~0V).

Backlight Output Mode

This provides PWM duty-cycle output or DAC voltage output.

PWM Frequency Selection

This provides 4 frequency Selection.

F81866 H/W Monitor

Aptio Setup Utility

Main	Advanced	Chipset	Boot	Security	Save & Exit
Pc Health Status					
CPU temperature		+39 C			
System temperature		+28 C			
CPU Fan Speed		N/A			
Vcore		+1.208 V			
+5V		+5.087 V			
+12V		+12.320 V			
+1.5V		+1.528 V			
+3.3V		+3.456 V			
ACPI Shutdown Temperature		Disabled			
CPU Smart Fan Control		Disabled			
				→ Select Screen ↑↓ Select Item Enter: Select +- Change Field F1: General Help F2: Previous Values F3: Optimized Default F4: Save ESC: Exit	

ACPI Shutdown Temperature

The default setting is Disabled.

CPU Smart Fan Control

Disabled (default)

50 C

60 C

70 C

80 C

Temperatures/Voltages

These fields are the parameters of the hardware monitoring function feature of the motherboard. The values are read-only values as monitored by the system and show the PC health status.

PPM Configuration

Aptio Setup Utility

Main	Advanced	Chipset	Boot	Security	Save & Exit
PPM Configuration					
EIST		Enabled			→ ← Select Screen ↑ ↓ Select Item Enter: Select +- Change Field F1: General Help F2: Previous Values F3: Optimized Default F4: Save ESC: Exit

3.4 Chipset Settings

This section allows you to configure and improve your system and allows you to set up some system features according to your preference.

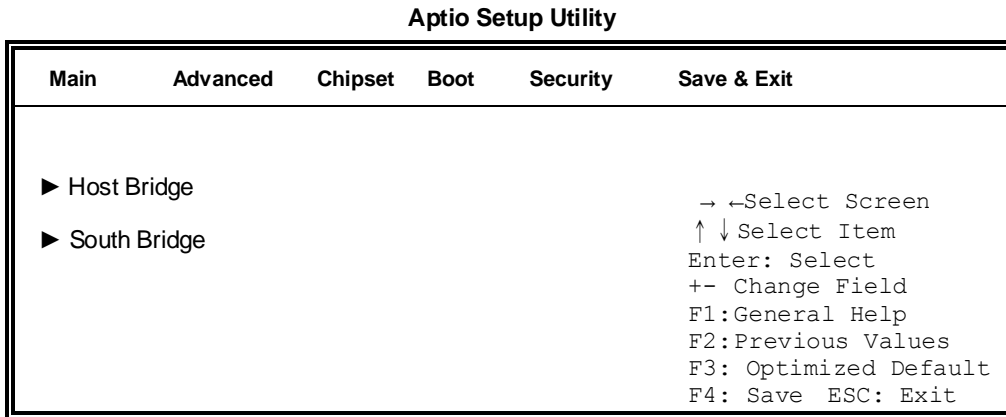

Host Bridge

This item shows the Host Bridge Parameters.

South Bridge

This item shows the South Bridge Parameters.

Host Bridge

This section allows you to configure the Host Bridge Chipset.

Aptio Setup Utility

Main	Advanced	Chipset	Boot	Security	Save & Exit
<p>▶ Memory Frequency and Timing</p> <p>▶ Intel IGD Configuration</p> <p>*****Memory Information*****</p> <p>Memory Frequency 1067 MHz(DDR3)</p> <p>Total Memory 2048 MB</p> <p>DIMM#1 2048 MB</p>					
					<p>→ ←Select Screen</p> <p>↑ ↓Select Item</p> <p>Enter: Select</p> <p>+ - Change Field</p> <p>F1:General Help</p> <p>F2:Previous Values</p> <p>F3: Optimized Default</p> <p>F4: Save ESC: Exit</p>

Memory Frequency and Timing

Aptio Setup Utility

Main	Advanced	Chipset	Boot	Security	Save & Exit
Memory Frequency and Timing					
MRC Fast Boot			Disabled		
					<p>→ ←Select Screen</p> <p>↑ ↓Select Item</p> <p>Enter: Select</p> <p>+ - Change Field</p> <p>F1:General Help</p> <p>F2:Previous Values</p> <p>F3: Optimized Default</p> <p>F4: Save & Exit</p> <p>ESC: Exit</p>

MRC Fast Boot

The options are Disabled and Enabled.

Intel IGD Configuration

Aptio Setup Utility

Main	Advanced	Chipset	Boot	Security	Save & Exit
Intel IGD Configuration					
Active LFP		Int-LVDS			→ ← Select Screen ↑ ↓ Select Item Enter: Select +- Change Field F1: General Help F2: Previous Values F3: Optimized Default F4: Save & Exit ESC: Exit

Active LFP

Select the Active LFP Configuration.

No LVDS: VBIOS does not enable LVDS.

Int-LVDS: VBIOS enables LVDS driver by Integrated encoder.

South Bridge

This section allows you to configure the South Bridge Chipset.

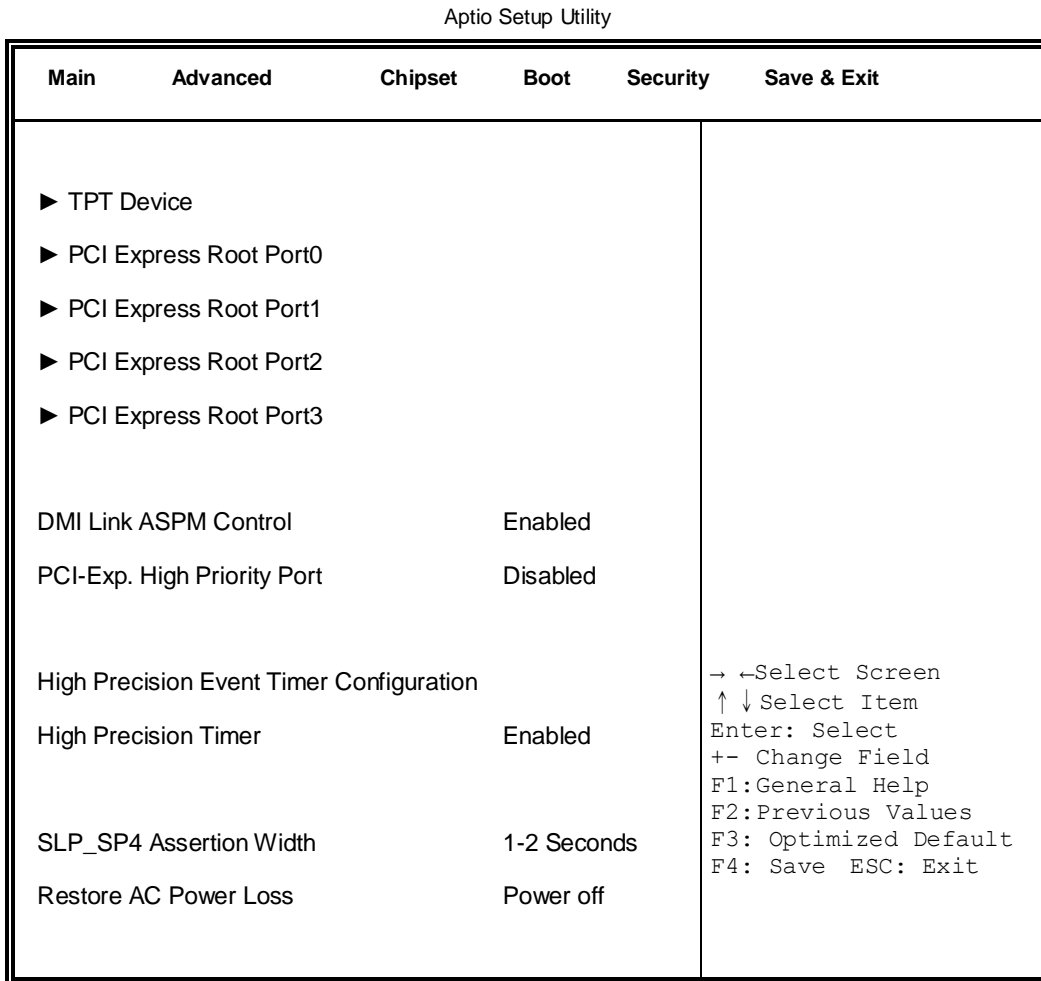

DMI Link ASPM Control

The control of Active State Power Management on both NB side and SB side of the DMI Link.

PCI-Exp. High Priority Port

The options are Disabled, Port1, Port2, Port3, and Port4.

High Precision Event Timer Configuration

Enable/or Disable the High Precision Event Timer.

SLP_S4 Assertion Stretch Enable

Select a minimum assertion width of the SLP_S4# signal.

TPT Device

Aptio Setup Utility

Main	Advanced	Chipset	Boot	Security	Save & Exit
Azalia Controller		HD Audio			
UHCI #1 (port 0 and 1)		Enabled			
UHCI #2 (port 2 and 3)		Enabled		→ ←Select Screen ↑ ↓Select Item Enter: Select +- Change Field F1:General Help F2:Previous Values F3: Optimized Default F4: Save ESC: Exit	
UHCI #3 (port 4 and 5)		Enabled			
UHCI #4 (port 6 and 7)		Enabled			
USB 2.0(UHCI) Support		Enabled			

PCI Express Root Port0

Aptio Setup Utility

Main	Advanced	Chipset	Boot	Security	Save & Exit
PCI Express Port 0		Enabled			
Port 0 IOxAPIC		Disabled			
Automatic ASPM		Manual		→ ←Select Screen ↑ ↓Select Item Enter: Select +- Change Field F1:General Help F2:Previous Values F3: Optimized Default F4: Save ESC: Exit	
ASPM L0s		Root Port Only			
ASPM L1		Enabled			

PCI Express Root Port1

Aptio Setup Utility

Main	Advanced	Chipset	Boot	Security	Save & Exit
PCI Express Port 1			Auto		
Port 0 IOxAPIC			Disabled		
Automatic ASPM			Manual		→ ←Select Screen ↑ ↓Select Item Enter: Select +- Change Field F1:General Help F2:Previous Values F3: Optimized Default F4: Save ESC: Exit
ASPM L0s			Root Port Only		
ASPM L1			Enabled		

PCI Express Root Port2

Aptio Setup Utility

Main	Advanced	Chipset	Boot	Security	Save & Exit
PCI Express Port 2			Auto		
Port 0 IOxAPIC			Disabled		→ ←Select Screen ↑ ↓Select Item Enter: Select +- Change Field F1:General Help F2:Previous Values F3: Optimized Default F4: Save ESC: Exit
Automatic ASPM			Manual		
ASPM L0s			Disabled		
ASPM L1			Disabled		

PCI Express Root Port3

Aptio Setup Utility

Main	Advanced	Chipset	Boot	Security	Save & Exit
PCI Express Port 3			Auto		
Port 0 IOxAPIC			Disabled		
Automatic ASPM			Manual	→ ←Select Screen	
ASPM L0s			Disabled	↑↓Select Item	
ASPM L1			Disabled	Enter: Select	
				+- Change Field	
				F1:General Help	
				F2:Previous Values	
				F3: Optimized Default	
				F4: Save ESC: Exit	

Boot Settings

Aptio Setup Utility

Main	Advanced	Chipset	Boot	Security	Save & Exit
Boot Configuration					
Setup Prompt Timeout			1		
Bootup NumLock State			On		
Quiet Boot			Disabled		
Fast Boot			Disabled		
CSM16 Module Version			07.68		
GateA20 Active			Upon Request		
Option ROM Messages			Force BIOS		→ ←Select Screen ↑ ↓ Select Item
Interrupt 19 Canture			Disabled		Enter: Select +- Change Field F1:General Help F2:Previous Values F3: Optimized Default F4: Save ESC: Exit
Boot Option Priorities					

Setup Prompt Timeout

Number of seconds to wait for setup activation key.
65535(0xFFFF) means indefinite waiting.

Bootup NumLock State

Select the keyboard NumLock state.

Quiet Boot

Enables/Disables Quiet Boot option.

Fast Boot

Enables/Disables boot with initialization of a minimal set of devices required to launch active boot option. Has no effect for BBS boot options.

GateA20 Active

UPON REQUEST – GA20 can be disabled using BIOS services.

ALWAYS – do not allow disabling GA20; this option is useful when any RT code is executed above 1MB.

Option ROM Messages

Set display mode for Option ROM. Options: Force BIOS and Keep Current.

Interrupt 19 Capture

Enable: Allows Option ROMs to trap Int 19.

Boot Option Priorities

Sets the system boot order

Security Settings

This section allows you to configure and improve your system and allows you to set up some system features according to your preference.

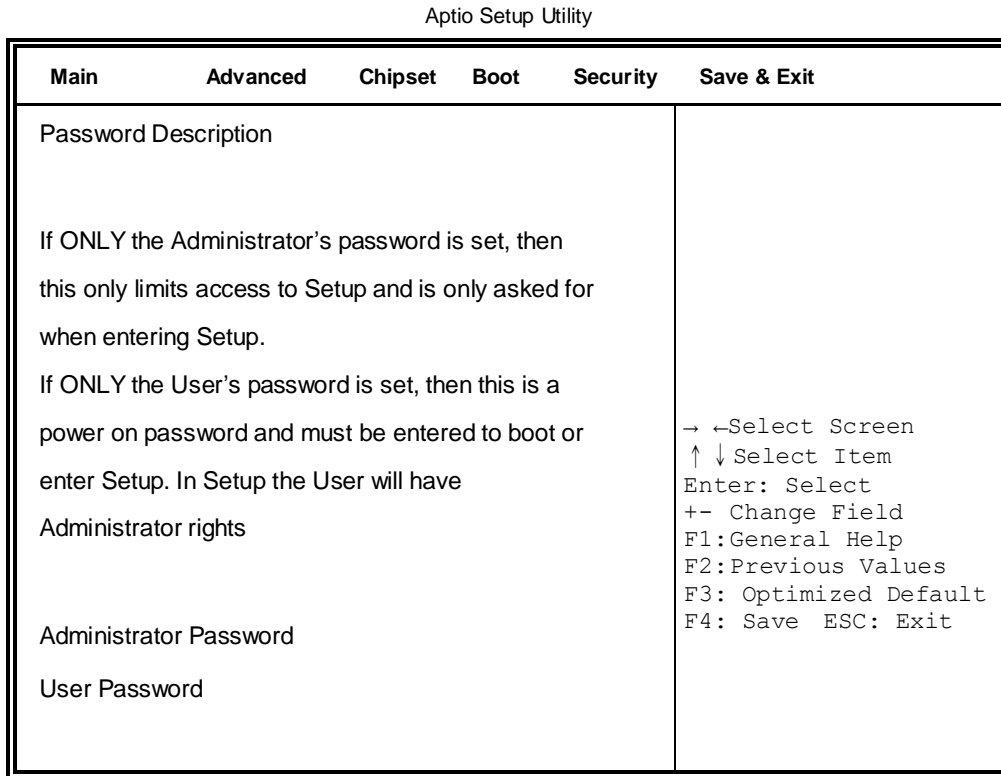

Administrator Password

Set Setup Administrator Password.

User Password

Set User Password.

Save & Exit Settings

Aptio Setup Utility

Main	Advanced	Chipset	Boot	Security	Save & Exit
Save Changes and Exit					
Discard Changes and Exit					
Save Changes and Reset					
Discard Changes and Reset					
Save Options					
Save Changes					
Discard Changes					
Restore Defaults					→ ←Select Screen
Save as User Defaults					↑ ↓Select Item
Restore User Defaults					Enter: Select
					+ - Change Field
					F1:General Help
					F2:Previous Values
					F3: Optimized Default
					F4: Save ESC: Exit
Boot Override					

Save Changes and Exit

Exit system setup after saving the changes.

Discard Changes and Exit

Exit system setup without saving any changes.

Save Changes and Reset

Reset the system after saving the changes.

Discard Changes and Reset

Reset system setup without saving any changes.

Save Changes

Save Changes done so far to any of the setup options.

Discard Changes

Discard Changes done so far to any of the setup options.

Restore Defaults

Restore/Load Defaults values for all the setup options.

Save as User Defaults

Save the changes done so far as User Defaults.

Restore User Defaults

Restore the User Defaults to all the setup options.

Boot Override

Pressing ENTER causes the system to enter the OS.

Launch EFI Shell from filesystem device

Attempts to Launch EFI Shell application (Shellx64.efi) from one of the available filesystem devices.

CHAPTER 4 DRIVERS INSTALLATION

This section describes the installation procedures for software and drivers. The software and drivers are included with the motherboard

IMPORTANT NOTE:

After installing your Windows operating system, you must install first the Intel Chipset Software Installation Utility before proceeding with the drivers installation.

4.1 Intel Chipset Software Installation Utility

The Intel Chipset Drivers should be installed first before the software drivers to enable Plug & Play INF support for Intel chipset components. Follow the instructions below to complete the installation.

1. Insert the disc that comes with the board. Click **Intel** and then **Intel(R) Cedar Trail Chipset Drivers**.



2. Click **Intel(R) Chipset Software Installation Utility**.



3. When the Welcome screen to the Intel® Chipset Device Software appears, click **Next** to continue.

4. Click **Yes** to accept the software license agreement and proceed with the installation process.

5. On the Readme File Information screen, click **Next** to continue the installation.

6. The Setup process is now complete. Click **Finish** to restart the computer and for changes to take effect.

4.2 VGA Drivers Installation

1. Insert the disc that comes with the board. Click **Intel** and then **Intel(R) Cedar Trail Chipset Drivers**.



2. Click **Intel(R) Cedar Trail Graphics Driver**.

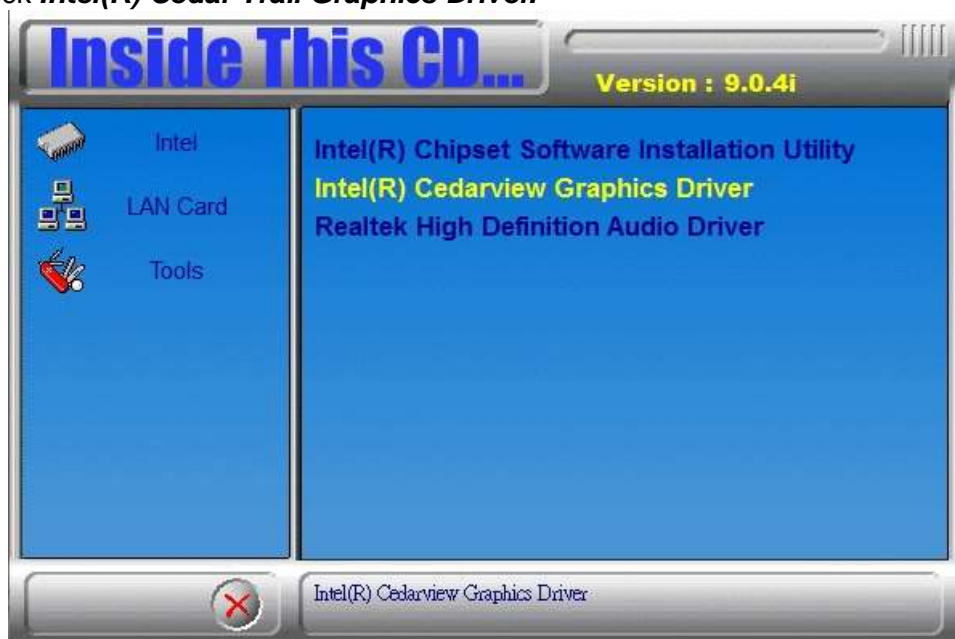

3. When the Welcome screen appears, click **Next** to continue.



4. Click **Yes** to agree with the license agreement and continue the installation.

5. On the Readme File Information screen, click **Next** to continue the installation of the Intel® Graphics Media Accelerator Driver.

6. On Setup Progress screen, click **Next** to continue.

7. Setup complete. Click **Finish** to restart the computer and for changes to take effect.

4.3 Realtek HD Audio Driver Installation

Follow the steps below to install the Realtek HD Audio Drivers.

1. Insert the disc that comes with the board. Click **Intel** and then **Intel(R) Cedar Trail Chipset Drivers**.



2. Click **Realtek High Definition Audio Driver**.



3. On the Welcome to the InstallShield Wizard screen, click **Next** to proceed with and complete the installation process.

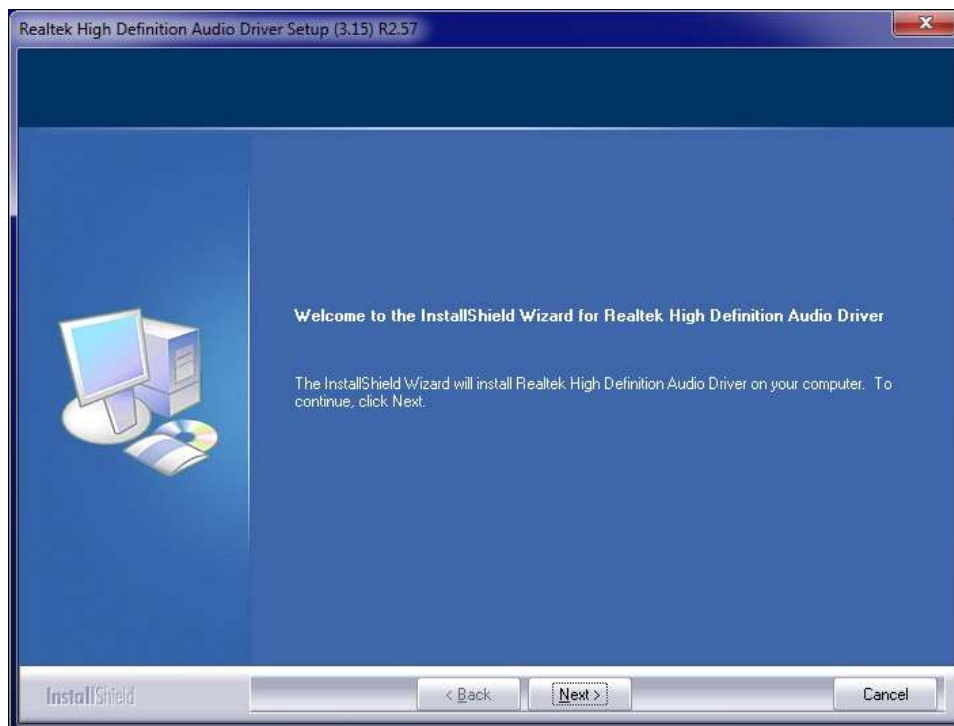

4. Restart the computer when prompted.

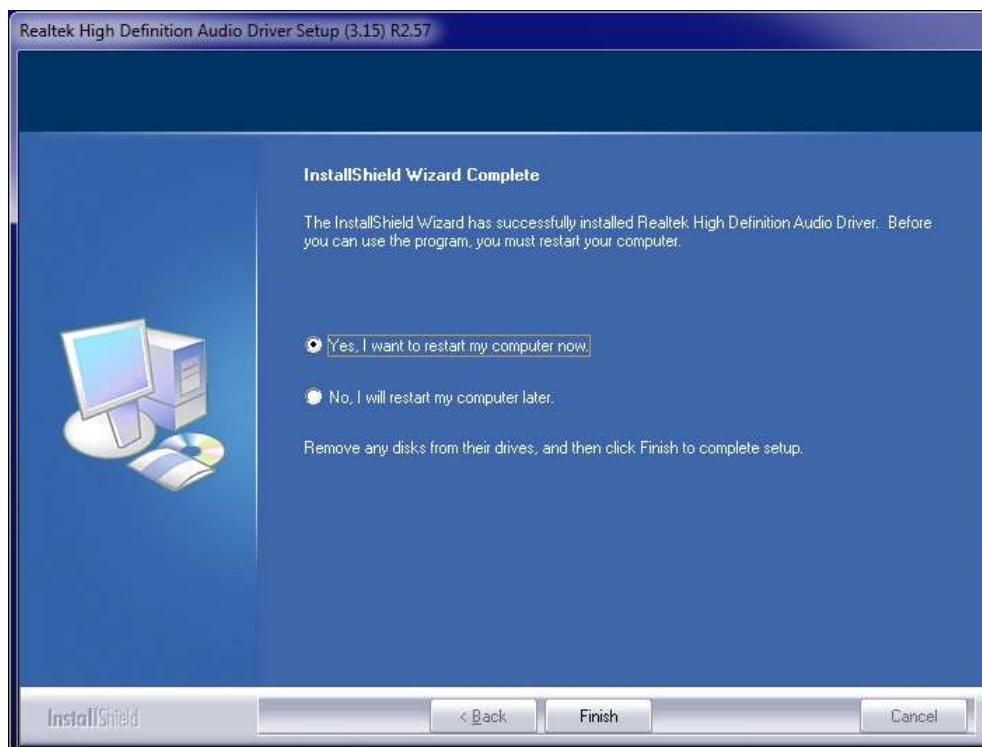

4.4 Realtek LAN Controller Drivers Installation

Follow the steps below to install the Realtek LAN Drivers.

1. Insert the CD that comes with the board. Click **LAN Card**, and then **Realtek Lan Controller Drivers**.



2. Click **Realtek RTL8111G LAN Drivers**.



3. When the welcome screen to InstallShield Wizard appears, click **Next** to start the installation.

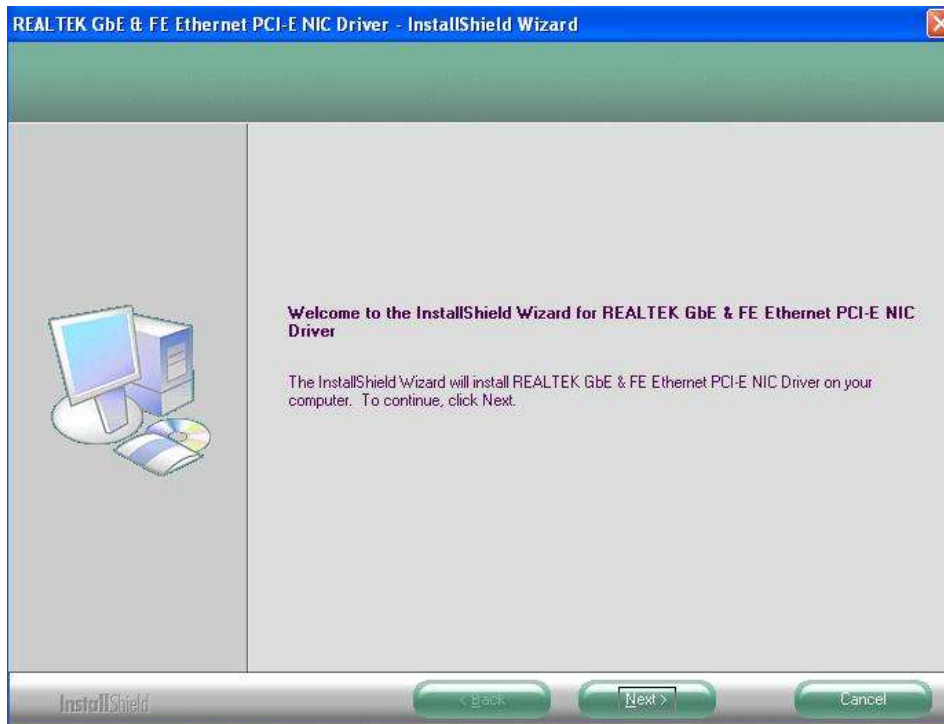

4. When the InstallShield Wizard has finished installing the Realtek LAN drivers, click **Finish**.

