



**DOT MATRIX
LIQUID CRYSTAL DISPLAY
MODULE**

COMPANY NAME : Mc' Tronic

USER'MANUAL

SC01602P0-01 Serial

LCD Module Description: SCS01602P0JEW13

PROPOSED BY		APPROVED
Design	Approved	
		

Sample Delivery Date: 2017.06.26 (Ver.2017.10.23)

SDEC TECHNOLOGY CORP.

ADDRESS: 10F, No.98, Shing De Rd., San Chung Dist. 241

New Taipei City, Taiwan R.O.C.

TEL: 886-2-2999-2512/886-2-8512-1288

FAX: 886-2-2999-2510/886-2-8512-2828

EMAIL:sdec8405@ms6.hinet.net/sdec@sdec.com.tw

<http://www.sdec.com.tw>



LCM SAMPLE APPROVAL

(液晶顯示模組樣品確認書)

1 · PART A: FILLED BY SDEC TECH (由 SDEC 填寫)

- 1) COMPANY NAME (客戶名稱) : Mc' Tronic
- 2) SDEC ITEM NO. (產品型號) : SCS01602P0JEW13
- 3) CUSTOMER ITEM NO. (客戶產品型號) : DS11004602
- 4) LCM Function (LCM 內容) :

A	LCD TYPE (LCD 種類) : <input type="checkbox"/> TN, <input type="checkbox"/> HTN, <input checked="" type="checkbox"/> STN, <input type="checkbox"/> FSTN (<input type="checkbox"/> POSITIVE/正向, <input checked="" type="checkbox"/> NEGATIVE/反向, <input type="checkbox"/> BLACK MASK/內黑絲印)
B	VIEWING AREA (視角方向) : <input type="checkbox"/> 3H, <input checked="" type="checkbox"/> 6H, <input type="checkbox"/> 9H, <input type="checkbox"/> 12H
C	POLARIZER COLOR (偏光板顏色) : <input type="checkbox"/> GRAY/灰色, <input type="checkbox"/> YELLOW GREEN/黃綠色, <input checked="" type="checkbox"/> BLUE/藍色, <input type="checkbox"/> BLACK/黑色 Note: In LCD production, it will occur slightly color difference. We can only guarantee the same color in the same batch.
D	BACKLIGHT COLOR (背光顏色) : <input type="checkbox"/> YELLOW GREEN/黃綠光, <input type="checkbox"/> ORANGE/橘光, <input type="checkbox"/> RED/紅光, <input type="checkbox"/> BLUE/藍光, <input type="checkbox"/> GREEN/翠綠光, <input checked="" type="checkbox"/> WHITE/白光
E	TEMPERATURE (溫度) : <input type="checkbox"/> NORMAL/常溫, <input checked="" type="checkbox"/> WIDE/廣溫
F	JUMPER : <input type="checkbox"/> JA <input type="checkbox"/> JK <input type="checkbox"/> J1 <input type="checkbox"/> J2
G	CONTROL IC (控制 IC) : ST7066U-0A-B

SAMPLE DELIVERY DATE (出樣日期) : 2017.06.26

2 · PART B: FILLED BY CUSTOMER (請客戶填寫)

CHECK LIST ITEMS (檢查項目) :	O K	NG	REASON (原因)
1). LCM SIZE AND THICKNESS: (LCM 尺寸及厚度) :	<input type="checkbox"/>	<input type="checkbox"/>	_____
2). POLARIZER COLOR : (偏光板色澤) :	<input type="checkbox"/>	<input type="checkbox"/>	_____
3). ELECTRO CHARACTERISTIC : (電氣特性) :	<input type="checkbox"/>	<input type="checkbox"/>	_____
4). VIEWING AREA (視角範圍) :	<input type="checkbox"/>	<input type="checkbox"/>	_____
5). BACKLIGHT ILLIMINATION (背光亮亮度) :	<input type="checkbox"/>	<input type="checkbox"/>	_____
6). TEMPERATURE RANGE (溫度範圍) :	<input type="checkbox"/>	<input type="checkbox"/>	_____
APPROVED BY (批准) :	DATE OF APPROVAL (批准日期) :		



REVISION RECORD

Revision	Page	Contents
2010.07		First Release Version Item No: LMC-SSC2P16DLNW-E-A03 Change to SCS01602P0JEW13
2015.01.20		Release New Spec
2016.04.25	2	Sample Delivery Date
	2	Customer Item No. DS11002275 change to DS11004413 LCD Change Supplier, Release New Spec
2017.06.26	2	New Sample Delivery Date Control IC:SPLC780D1-01 change to ST7066U-0A-B
	7-10	Timing Control change for ST7066U-0A-B
2017.10.23	2	Customer Item No. DS11004413 (SPLC780D1-01) Change to DS11004602(ST7066U-0A-B)

SDEC LCD Module Numbering System

1	2	3	4	5	6	7	8	9	10	11	12	13	14	15
S	C	S		040		04		A0		H	L	T	1	0
S	G	F		320		24		A0		J	C	W	1	0
S	D	H		007		08		A0		B	N	N	0	0

Numbering System			Code Value	Description	Remark
1	Company	S	S	Company name abbreviated	SDEC CO.,LTD
2	LCM type	G	B C G O T S D	B:Big Character C:Character G:Graphic O:COG T:TAB S:Seven Segment D:Customer Design	LCM type
3	LCD type	S	T H S F D R M V A	TN type LCD HTN type LCD STN type LCD FSTN type LCD DFSTN type LCD Color TN / Color STN TFT LCD VFD VATN	LCD type
4,5,6	Row dots number Characters per line Year	128	122,128,240,320... 008,016,020,040... 006,007...	Row dots number Characters per line Year	Graphic Character Seven Segment
7,8	Column dots number Lines Month	64	32,64,128,240... 01,02,04... 01,02..12	Column dots number Lines Month	Graphic Character Seven Segment
9,10	LCD module serial number	A0	A0~ZZ	LCD module serial number	Ux -> USB Port Interface Sx -> Series Port Interface Rx -> RS-232 Port Interface
11	Polarizer Color & Viewing angle type	I	A B C D E F G H I J K L M	Gray Mode/3:00view Gray Mode/6:00view Gray Mode/9:00view Gray Mode/12:00view Yellow Green Mode/3:00view Yellow Green Mode/6:00view Yellow Green Mode/9:00view Yellow Green Mode/12:00view Negative type/3:00view Negative type/6:00view Negative type/9:00view Negative type/12:00view Other	Polarizer Color & Viewing angle type
12	Backlight type	L	N L E C	Without backlight Array LED Edge LED C.C.F.L	Backlight type
13	Backlight color (VFD color)	Y	N O B G R Y W D T	Without backlight Orange (Amber) Blue Green Red Yellow-green White Double Color(Y-G&R) R G B	Backlight color
14	Font Code Type	0	0 1 2 3 A B C F U Z	No Font Table English-Japanese Font Code English-Europe Font Code English-Russian Font Code BIG-5 Chinese Font Code GB Chinese Font Code ST7920-0C Font Code ST7920-0F Font code (Korean) Unicode Other Font Code	Font Table Code Type
15	Series Code	0	0~Z		Series Code

CONTENTS

	PAGE
● LCM Sample Approval	2
● REVISION RECORD	3
● LCD Module Number System	4
1. Mechanical Specification	6
2. Mechanical Diagram	6
3. Interface Pin Connections	6
4. Block Diagram	6
5. Absolute Maximum Ratings	7
6. Electrical Characteristics	7
7. Optical Characteristics	7
8. Optical Definitions	7
9. Display Address	7
10. Interface to MPU	8
10.1 Interface to Z-80 CPU	8
10.2 Interface to MC6800 CPU	8
10.3 Interface to 4-bit CPU (HMCS43C)	8
10.4 Interface to HD6805 MP	8
11. Timing Control	8
11.1 Write and Read Operation	8
11.2 Busy flag check timing	8
12. Initialization of LCM	9
13. Instruction Set	10
14. User Font Patterns	10
15. Software Example	11
15.1 8-bit operation (8 bits 2 lines)	11
15.2 4-bit operation (4 bits 2 lines)	11
16. Character Generator ROM Map	12
17. Function Test & Inspection Criteria	13
18. Reliability Test – Normal Temperature	15
19. Reliability Test – Wide Temperature	16
20. Precautions Against Product Handling	17
21. Warranty	18

1. Mechanical Specification

ITEM	STANDARD VALUE	UNIT
NUMBER OF CHARACTERS	16 CHARACTERS X 2 LINES	--
CHARACTER FORMAT	5 X 8 DOTS	--
MODULE DIMENSION	80.0 (W) X 36.0 (H) X 11.5 (T)	mm
VIEWING DISPLAY AREA	65.0 (W) X 16.0 (H)	mm
ACTIVE DISPLAY AREA	56.21 (W) X 11.50 (H)	mm
CHARACTER SIZE	2.96 (W) X 5.56 (H)	mm
CHARACTER PITCH	3.55 (W) X 5.94 (H)	mm
DOT SIZE	0.56 (W) X 0.60 (H)	mm
DOT PITCH	0.60 (W) X 0.70 (H)	mm
● EDGE LED BACKLIGHT COLOR	WHITE	
BACKLIGHT INPUT	DC +4.0V	V
BACKLIGHT HALF-LIFT TIME	20,000 (AVOID LIGHTING CONTINUOUSLY , Ta=25°C)	

2. Mechanical Diagram

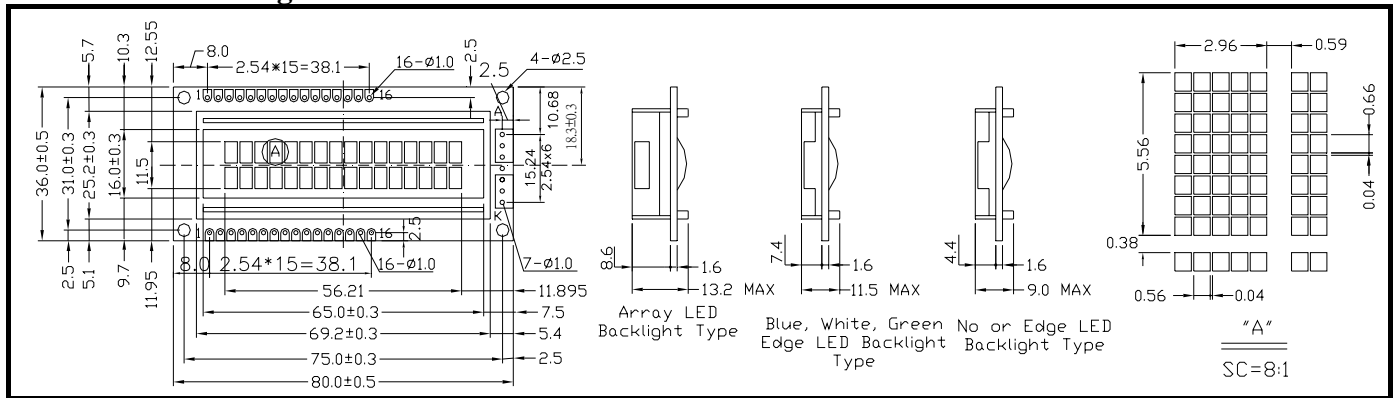

3. Interface Pin Connections

NO	SYMBOL	LEVEL	FUNCTION
1	VSS	--	GND (0V)
2	VDD	--	DC +5V
3	VO	--	Contrast Adjust
4	RS	H/L	Register select
5	R/W	H/L	Read/Write
6	E	H,H→L	Enable signal
7	DB0	H/L	Data Bit 0
8	DB1	H/L	Data Bit 1
9	DB2	H/L	Data Bit 2
10	DB3	H/L	Data Bit 3
11	DB4	H/L	Data Bit 4
12	DB5	H/L	Data Bit 5
13	DB6	H/L	Data Bit 6
14	DB7	H/L	Data Bit 7
15	A(+)	DC+5.0V	LED Backlight +
16	K(-)	0V	LED Backlight -

4. Block Diagram

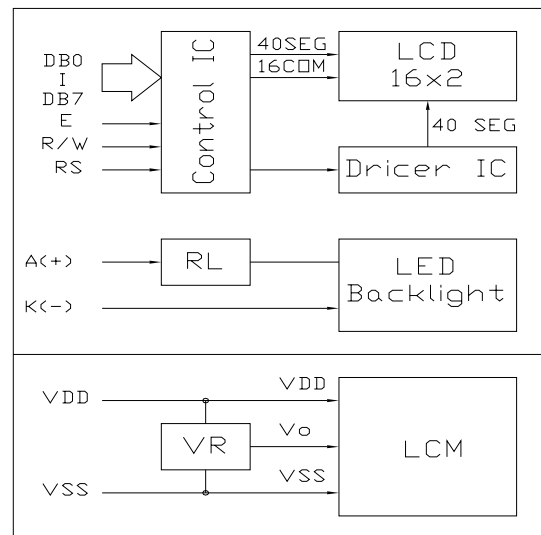

5. Absolute Maximum Ratings

ITEM	SYMBOL	MIN.	TYPE	MAX.	UNIT	
INPUT VOLTAGE	VI	VSS	—	VDD	V	
SUPPLY VOLTAGE FOR LOGIC	VDD-VSS	—	5.0	6.5	V	
SUPPLY VOLTAGE FOR LCD	VDD-VO	—	—	6.5	V	
TN	NORMAL TEMPERATURE RANGE	OPERATING	0~+50	STORAGE	-10~+60	°C
HTN	WIDE TEMPERATURE RANGE	OPERATING	-20~+70	STORAGE	-30~+80	°C
STN	WIDE TEMPERATURE RANGE	OPERATING	-20~+70	STORAGE	-30~+80	°C
FSTN	WIDE TEMPERATURE RANGE	OPERATING	-20~+70	STORAGE	-30~+80	°C
STATIC ELECTRICITY		Be sure that you are grounded when handing LCM.				

6. Electrical Characteristics

ITEM	SYM	CONDITION	MIN.	TYPE	MAX.	UNIT
SUPPLY VOLTAGE FOR LOGIC	VDD-VSS	—	4.5	5.0	5.5	V
SUPPLY VOLTAGE FOR LCD	VDD-VO	Ta=-20°C	—	4.8	—	V
		Ta=+25°C	4.1	4.3	4.5	V
		Ta=+70°C	—	3.9	—	V
INPUT HIGH VOLTAGE	VIH	—	0.7VDD	—	VDD	V
INPUT LOW VOLTAGE	VIL	—	0	—	0.6	V
OUTPUT HIGH VOLTAGE	VOH	—	3.9	—	—	V
OUTPUT LOW VOLTAGE	VOL	—	—	—	0.4	V
SUPPLY CURRENT	IDD	VDD=+5V	—	3.0	4.5	mA

7. Optical Characteristics

Ta at 25°C

ITEM	SYM	CONDITION	MIN.	TYPE	MAX.	UNIT
VIEW ANGLE (TOP/BOTTOM)	$\theta 1 \sim \theta 2$	$CR \geq 2$	-35°	—	45°	deg.
VIEW ANGLE (LEFT/RIGHT)	$\varphi 1 \cdot \varphi 2$	$CR \geq 2$	-35°	—	35°	deg.
CONTRAST RATIO	CR	—	—	4.5	—	—
RESPONSE TIME (RISE)	TON/Tr	—	—	170	—	mS
RESPONSE TIME (DECAY)	TOFF/Tf	—	—	220	—	mS

8. Optical Definitions

Response Time

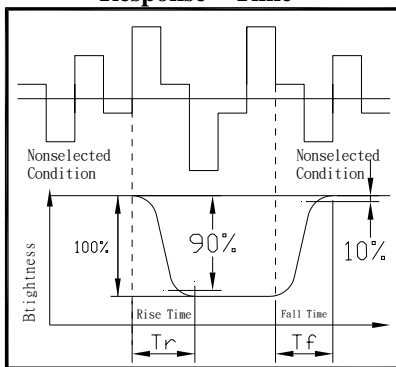

Contrast Ratio

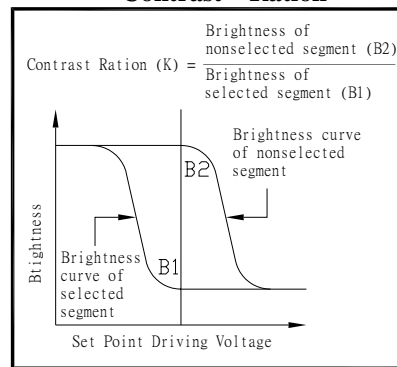

View Angle

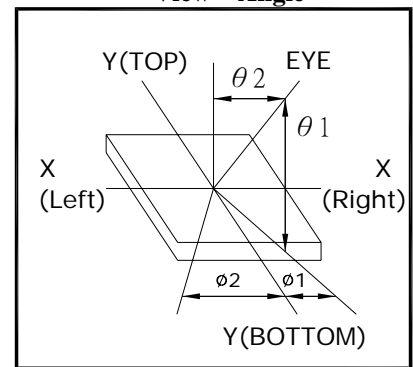

9. Display Address

	1	2	3	4	5	6	7	8	9	10	11	12	13	14	15	16	17	18	19	20
Line 1	80	81	82	83	84	85	86	87	88	89	8A	8B	8C	8D	8E	8F				
Line 2	C0	C1	C2	C3	C4	C5	C6	C7	C8	C9	CA	CB	CC	CD	CE	CF				
Line 3																				
Line 4																				

	21	22	23	24	25	26	27	28	29	30	31	32	33	34	35	36	37	38	39	40
Line 1																				
Line 2																				
Line 3																				
Line 4																				

10. Interface to MPU

10.1 Interface to Z-80 CPU

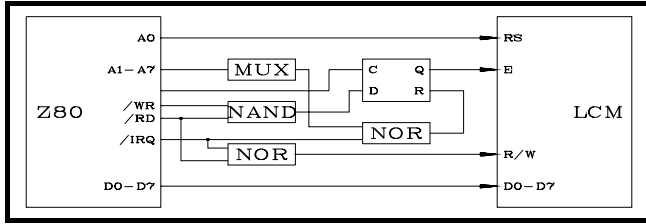

10.2 Interface to MC6800 CPU

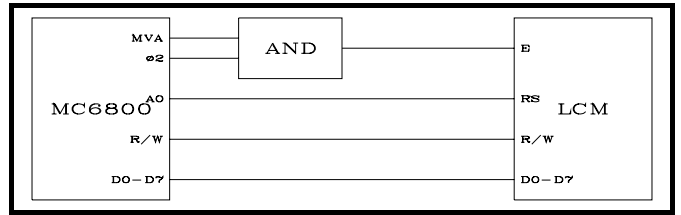

10.3 Interface to 4-bit CPU (HMCS43C)

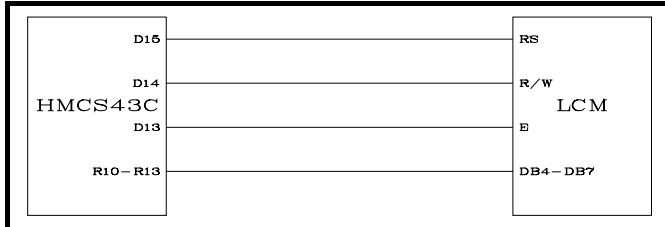

10.4 Interface to HD6805 MP

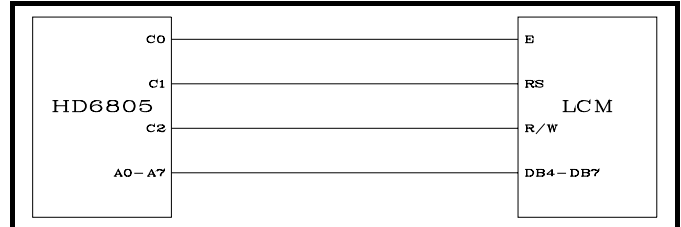

11. Timing Control

11.1 Write and Read Operation

Write Operation

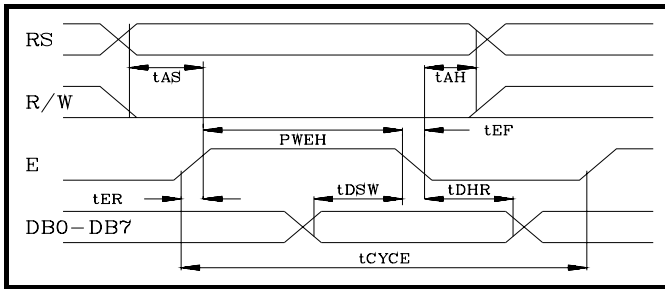

Read Operation

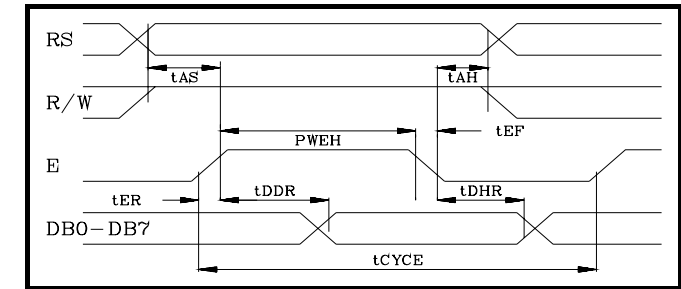

Item	Symbol	Limit (Min.)	Limit (Max.)	Unit
Enable Cycle Time	tCYCE	1200	--	ns
Enable Pules Width (High level)	PWEH	140	--	ns
Enable Rise/Fall Time	tER,tEF	--	25	ns
Address Set-Up Time (RS,R/W,E)	tAS	0	--	ns
Address Hole Time	tAH	10	--	ns
Data Set-Up Time	tDSW	40	--	ns
Data Delay Time	tDDR	--	100	ns
Data Hold Time	tDHR	10	--	ns

11.2 Busy flag check timing

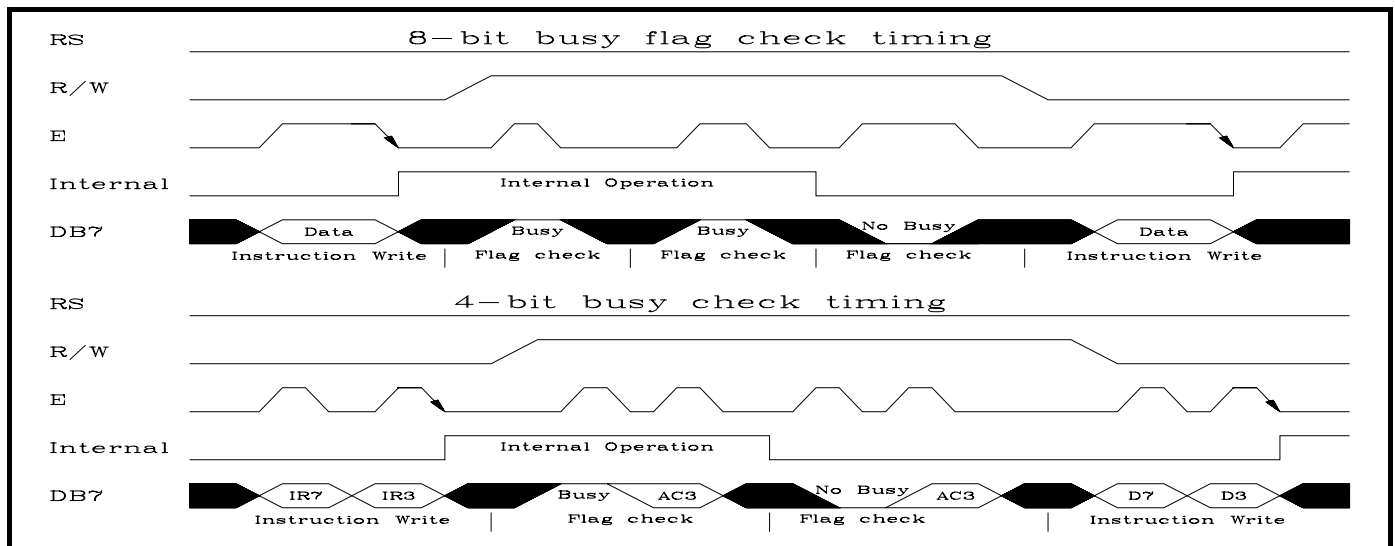

Note: IR7, IR3: Instruction 7th bit, 3rd bit; AC3: Address Counter 3rd bit.

12. Initialization of LCM

The LCM automatically initializes (reset) when power is turned on using the internal reset circuit. If the power supply conditions for correctly operating of the internal reset circuit are not met, initialization by instruction is required. Use the procedure is next page for initialization.

Internal Power Supply reset

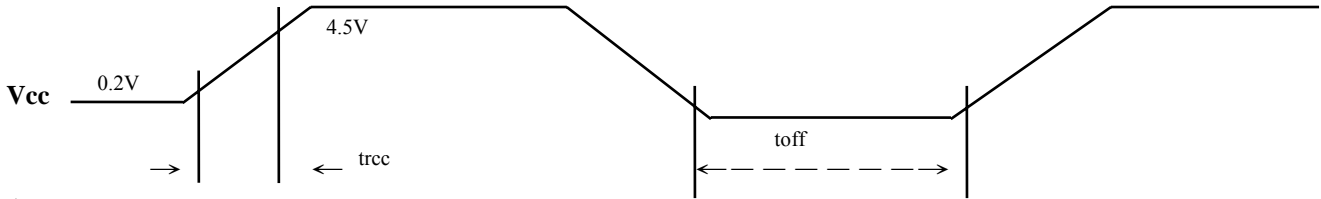

(Note 1) $100\text{ ms} \geq \text{trcc} \geq 0.1\text{ ms}$, $\text{toff} \geq 1\text{ ms}$.

(Note 2) toff stipulates the time of power OFF for momentary power supply dip or when power supply cycles ON and OFF.

Item	Symbol	Test condition	Limit (Min.)	Limit (Max.)	Unit
Power supply rise time	trcc	--	0.1	100	ms
Power supply off time	toff	--	1	--	ms

(a) 8-bit interface

(b) 4-bit interface

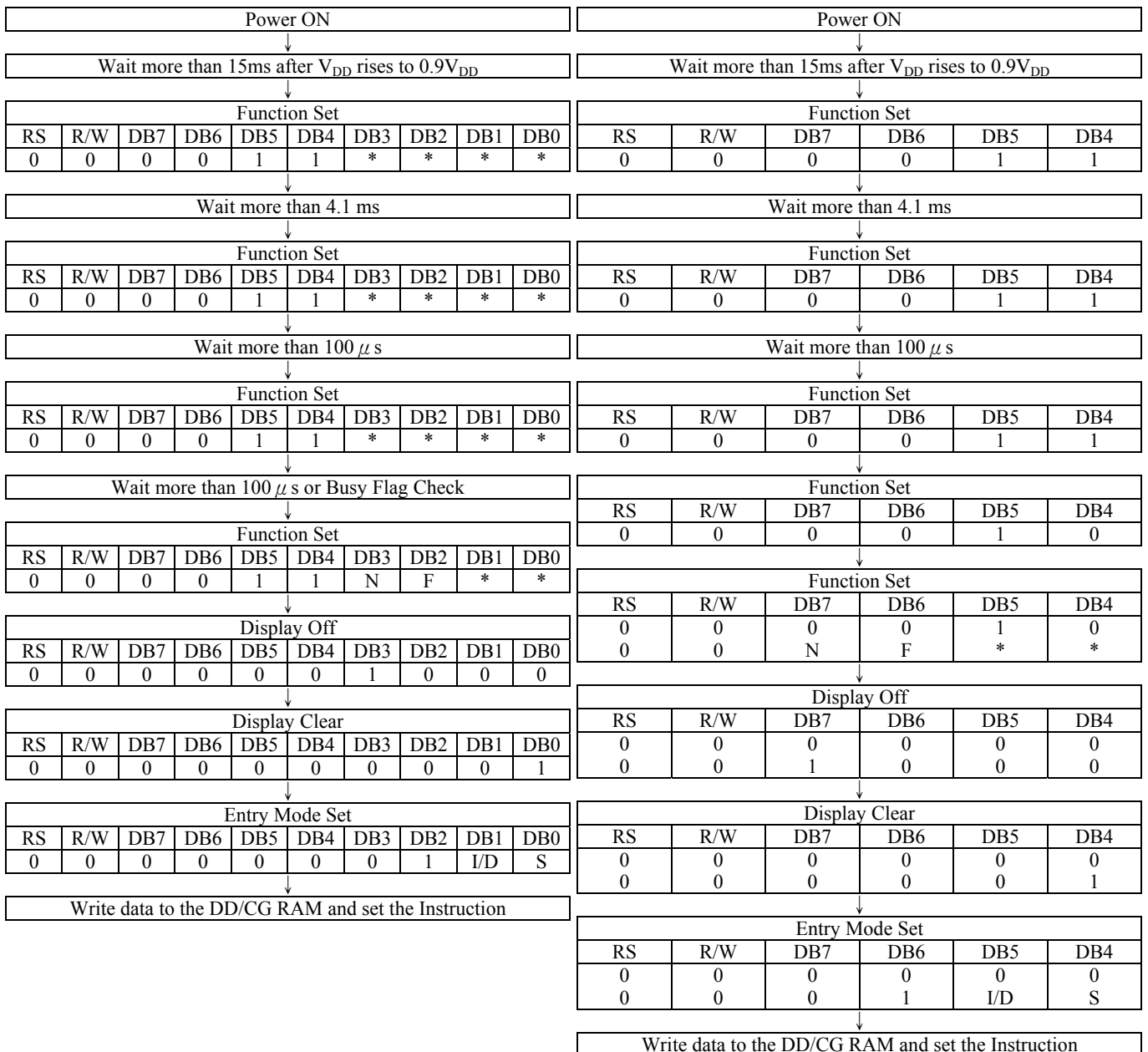

13. Instruction Set

FUNCTION	R S	R /W	D B 7	D B 6	D B 5	D B 4	D B 3	D B 2	D B 1	D B 0	DESCRIPTION	EXECU. TIME (270KHz)
Clear Display	0	0	0	0	0	0	0	0	0	1	Clears entire display and returns the cursor to home position (address 0).	1.52ms
Return Home	0	0	0	0	0	0	0	0	1	x	Return the cursor to the home position. Also returns the display being shifted to the original position. DD RAM contents remain unchanged.	1.52ms
Entry mode set	0	0	0	0	0	0	0	1	I / D	S	Set cursor move direct and specifies display shift. These operations are performed during data rite/read. For normal operation, set S to zero. I/D=1: increment; 0: decrement; S=1: accompanies display shift when data is written, for normal operation, set to zero.	37 μs
Display ON/OFF control	0	0	0	0	0	0	1	D	C	B	Set ON/OFF all display (D), cursor ON/OFF(C), and blink of cursor position character(B). D=1: ON display; 0:OFF display. C=1: ON cursor;0: OFF cursor. B=1: ON blink cursor; 0: OFF blink cursor.	37 μs
Cursor or Display shift	0	0	0	0	0	1	S / C	R / L	x	x	Move the cursor and shift the display without changing DD RAM contents. S/C=1: Display shift; 0:Cursor move. R/L=1: shift to right; 0: shift to left.	37 μs
Function Set	0	0	0	0	1	D L	N	F	x	x	Set the interface data length (DL). Number of display lines (N) and character font (F). DL=1: 8 bits; 0:4 bits. N=1: 2 lines; 0: 1 lines. F=1: 5x10 dots; 0: 5x7 dots.	37 μs
Set CG RAM address	0	0	0	1	ACG					Set CG RAM address. CG RAM data is sent and received after this setting.	37 μs	
Set DD RAM address	0	0	1	ADD					Set DD RAM address. DD RAM data is sent and received after this setting	37 μs		
Read busy flag & address	0	1	B F	AC					Reads Busy Flag (BF) indicating internal operation is being performed and reads address counter contents. BF=1: internally operating. 0: can accept instruction	--		
Write Data to CG/DDRAM	1	0	WRITE DATA					Write data into DD RAM or CG RAM.			37 μs	
Read Data for CG/DDRAM	1	1	READ DATA					Read data from DD RAM or CG RAM			37 μs	

14. User Font Patterns (CG RAM Character)

Character Code (DD RAM data)	CG RAM Address	Character Pattern (CG RAM data)
Hi 76543210 Lo	543 210	Hi 765 4 3 2 1 0 Lo
0000x000	000	xxx 1 1 1 1 0
	001	xxx 1 0 0 0 1
	010	xxx 1 0 0 0 1
	000 011	xxx 1 1 1 1 0
	100	xxx 1 0 1 0 0
	101	xxx 1 0 0 1 0
	110	xxx 1 0 0 0 1
	111	xxx 0 0 0 0 0
0000x001	000	xxx 1 0 0 0 1
	001	xxx 0 1 0 1 0
	010	xxx 1 1 1 1 1
	001 011	xxx 0 0 1 0 0
	100	xxx 1 1 1 1 1
	101	xxx 0 0 1 1 0
	110	xxx 0 0 1 0 0
	111	xxx 0 0 0 0 0
-----	-----	-----
0000x111	000	
	001	
	010	
	111 011	
	100	
	101	
	110	
	111	

15. Software Example

15.1 8-bit operation (8 bits 2 lines)

Function	R S	R w	D 7	D 6	D 5	D 4	D 3	D 2	D 1	D 0	Display	Description
Power on delay												Initialization. No display appears.
Function set	0	0	0	0	1	1	1	0	x	x		Sets to 8-bit operation and selects 2-line display and 5x7 dots character font. (Note: number of display lines and character fonts cannot be changed after this.)
Display OFF	0	0	0	0	0	0	1	0	0	0		Turn off display.
Display ON	0	0	0	0	0	0	1	1	1	0	_	Turn on display and cursor
Entry Mode Set	0	0	0	0	0	0	0	1	1	0	-	Set mode to increment the address by one and to shift the cursor to the right, at the time of write, to the DD/CG RAM Display is not shifted.
Write data to CG/DD RAM	1	0	0	1	0	1	0	0	1	1	S_	Write "S". Cursor incremented by one and shift to right.
Write data to CG/DD RAM	1	0	0	1	0	0	0	1	0	0	SDEC_	Write "D", "E", and "C".
Write data to CG/DD RAM	1	0	0	1	0	0	0	0	1	1		
Set DD RAM	0	0	1	1	0	0	0	0	0	0	SDEC	Set RAM address so that the cursor is propositioned at the head of the second line.
Write data to CG/DD RAM				*	*						SDEC CR_	Write "C" and "R".
Cursor or display shift	0	0	0	0	0	1	0	0	x	x	SDEC CR	Shift only the cursor position to the left.
Write data to CG/DD RAM				*	*						SDEC CO., LTD._	Write "O., LTD.".
Entry Mode Set	0	0	0	0	0	0	0	1	1	1	SDEC CO., LTD._	Set display mode shift at the time during writing operation.
Write data to CG/DD RAM	1	0	0	1	1	1	1	0	0	0	DEC O., LTD. x	Write "x". Cursor incremented by one and shift to right. (The display move to left.)
Write data to CG/DD RAM				*	*							Write other characters.
Return Home	0	0	0	0	0	0	0	0	1	0	SDEC CO., LTD.	Return both display and cursor to the original position (Set address to zero).

15.2 4-bit operation (4-bit, 1 line)

Function	RS	R/ W	D7	D6	D5	D4	Display	Description
Power on delay								Initialization. No display appears.
Function set	0	0	0	0	1	0		Sets to 4-bit operation. In this case, operation is handled as 8-bits by initialization, and only this instruction completes with one write.
Function set	0	0	0	0	1	0		Sets 4-bit operation and selects 1-line display and 5x7 dot character font on and resetting is needed. (Number of display lines and character fonts cannot be changed hence after).
Function set	0	0	0	0	x	x		
Display ON/OFF Control	0	0	0	0	0	0	-	Turn on display and cursor.
Display ON/OFF Control	0	0	1	1	1	0		
Entry Mode Set	0	0	0	0	0	0	-	Set mode to incremented the address by one and to shift the cursor to the right, at the time of write. To the DD/CG RAM display is not shifted.
Entry Mode Set	0	0	0	1	1	0		
Write data to CG/DD RAM	1	0	0	1	0	1	S_	Write "S". Cursor incremented by one and shift to right.
Write data to CG/DD RAM	1	0	0	0	1	1		

same as 8-bit operation

16. Character Generator ROM Map

Higher 4 bit Lower 4 bit		CHARACTER PATTERN CHART (5x7DOTS+CURSOR)												
		0000	0010	0011	0100	0101	0110	0111	1010	1011	1100	1101	1110	1111
Lower 4-bit (D0-D3) of Character Code (Hexadecimal)	xxxx0000	CG RAM (1)		0	1	2	3	4	5	6	7	8	9	A
	xxxx0001	(2)	!	1	A	Q	a	q	0	7	8	4	ä	q
	xxxx0010	(3)	"	2	B	R	b	r	1	7	8	x	pe	e
	xxxx0011	(4)	#	3	C	S	c	s	2	7	8	e	e	o
	xxxx0100	(5)	\$	4	D	T	d	t	3	7	8	h	h	o
	xxxx0101	(6)	%	5	E	U	e	u	4	7	8	l	o	ü
	xxxx0110	(7)	&	6	F	V	f	v	5	7	8	3	p	z
	xxxx0111	(8)	'	7	G	W	g	w	6	7	8	g	g	π
	xxxx1000	(1)	(8	H	X	h	x	7	7	8	u	r	x
	xxxx1001	(2))	9	I	Y	i	y	8	7	8	u	'	y
	xxxx1010	(3)	*	#	J	Z	j	z	9	7	8	n	v	j
	xxxx1011	(4)	+	#	K	C	k	c	8	7	8	e	o	*
	xxxx1100	(5)	,	<	L	*	l	l	9	7	8	7	o	π
	xxxx1101	(6)	-	=	M	I	m	i	0	7	8	7	u	+
	xxxx1110	(7)	.	>	N	^	n	+	0	7	8	7	ä	
	xxxx1111	(8)	/	?	O	_	o	+	0	7	8	7	ö	

17. Functional Test & Inspection Criteria

17.1 Sample plan

Sample plan according to MIL-STD-105D level 2, and acceptance/rejection criteria is.

Base on: Major defect: AQL 0.65 Minor defect: AQL 2.5

17.2 Inspection condition

Viewing distance for cosmetic inspection is 30cm with bare eyes, and under an environment of 800 lus (20W) light intensity. All direction for inspecting the sample should be within 45° against perpendicular line.

17.3 Definition of Inspection Zone in LCD

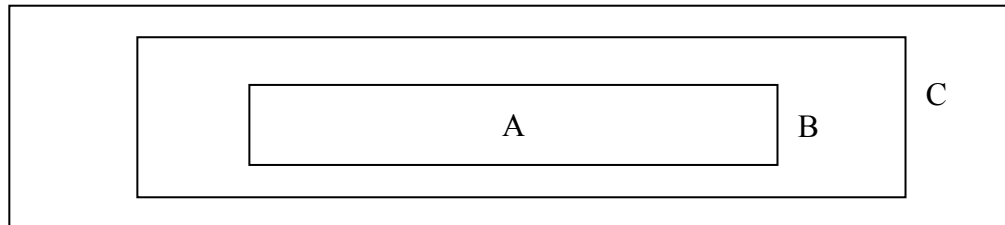

Zone A: Character / Digit area

Zone B: Viewing area except Zone A (Zone A + Zone B = minimum Viewing area)

Zone C: Outside viewing area (invisible area after assembly in customer's product)

Note: As a general rule, visual defects in Zone C are permissible, when it is no trouble for quality and assembly of customer's product.

17.4 Major Defect

All functional defects such as open (or missing segment), short, contrast differential, excess power consumption, smearing, leakage, etc. and overall outline dimension beyond the drawing. Are classified as major defects.

17.5 Inspection Parameters And Glass Pixel(偏光板和玻璃圖像檢驗)

No	Polarizer (偏光片)	Criteria		
1	Black or White spots and Piercing (黑/白點和刺孔)	Dimension (面積)		
		Acceptable number (可接受數量)		
		$D \leq 0.15$	*	
		$0.15 < D \leq 0.2$	6	
		$0.2 < D \leq 0.3$	2	
		$0.3 < D$	0	
D[面積]=(Length[長度]+Width[寬度])/2 * : Disregard(忽略)				
2	Scratch (刮傷)	X(mm)	Y(mm)	Acceptable number (可接受數量)
		*	$0.04 \geq W$	*
		$3.0 \geq L$	$0.06 \geq W$	4
		$2.0 \geq L$	$0.08 \geq W$	2
		--	$0.10 \geq W$	0
X : Length[長度] Y : Width[寬度] * : Disregard(忽略)				
3	Air Bubbles (between glass & polarizer) 氣泡 (玻璃跟偏光板之間)	Dimension (面積)		
		Acceptable number (可接受數量)		
		$D \leq 0.15$		
		$0.15 < D \leq 0.25$		
		$0.25 < D$		
* : Disregard(忽略)				

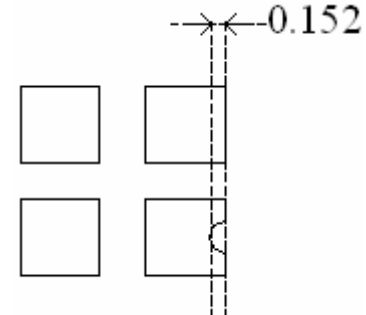
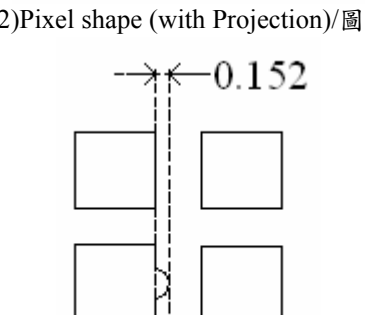
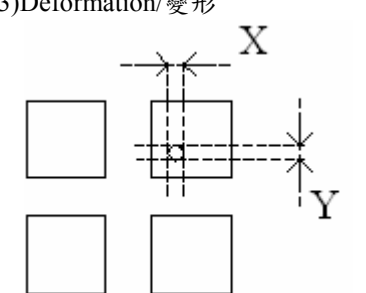
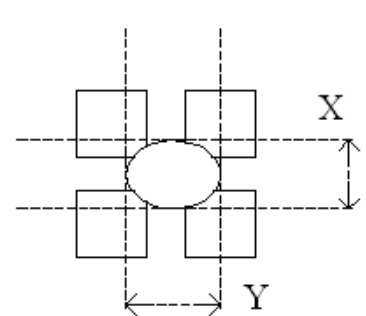
<p>4</p>	<p>Glass of Pixel (玻璃的圖像)</p>	<p>(1)Pixel shape (with Dent)/圖像凹度</p>  <p>•Less than 0.152 mm is no counted (小於 0.152mm 者不計)</p> <p>(2)Pixel shape (with Projection)/圖像凹度</p>  <p>Should not be connected next pixel (點與點間不可先連接)</p> <p>(3)Deformation/變形</p>  <p>$(X + Y) / 2 \leq 0.15\text{mm}$ •Less than 0.1 mm is no counted (小於 0.15mm 者不計)</p> <p>(4) Deformation/變形</p>  <p>$(X + Y) / 2 \leq 0.3\text{mm}$ •Less than 0.3 mm is no counted (小於 0.3mm 者不計)</p>
----------	-----------------------------------	---

18. Reliability Test (測試條件) – Normal Temperature (常溫)

No change no display and in operation under the following text condition.

(在不改變原先顯示下進行以下測試操作)

Conditions : Unless otherwise specified, test will be conducted under the following condition.

Temperature : $20\pm 5^{\circ}\text{C}$

Humidity : $40\pm 5\%\text{RH}$

Tests will be not conducted under functioning state.

(條件：除非其他特殊情況，否則測試將以溫度： $20\pm 5^{\circ}\text{C}$ ，濕度： $40\pm 5\%\text{RH}$ 為主)

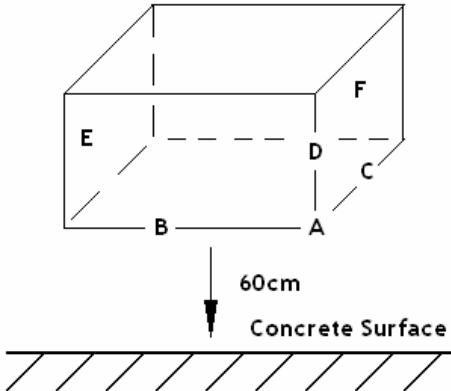
NO	Parameter	Conditions	Notes
1	High Temperature Operating	$50^{\circ}\text{C}\pm 2^{\circ}\text{C}$, 96 hrs (operation state) (96 小時，溫度 $50^{\circ}\text{C}\pm 2^{\circ}\text{C}$ 電源開啟的操作情況下)	
2	Low Temperature Operating	$0^{\circ}\text{C}\pm 2^{\circ}\text{C}$, 96 hrs (operation state) (96 小時，溫度 $0^{\circ}\text{C}\pm 2^{\circ}\text{C}$ 電源開啟的操作情況下)	1
3	High Temperature Storage	$60^{\circ}\text{C}\pm 2^{\circ}\text{C}$, 96 hrs (96 小時，溫度 $60^{\circ}\text{C}\pm 2^{\circ}\text{C}$ 電源關閉靜態操作下)	2
4	Low Temperature Storage	$-10^{\circ}\text{C}\pm 2^{\circ}\text{C}$, 96 hrs (96 小時，溫度 $-10^{\circ}\text{C}\pm 2^{\circ}\text{C}$ 電源關閉靜態操作下)	1, 2
5	Damp Proof Test	$40^{\circ}\text{C}\pm 2^{\circ}\text{C}$, 85 ~ 90%RH , 96hr (96 小時，溫度： $40^{\circ}\text{C}\pm 2^{\circ}\text{C}$ ，濕度： $85\sim 90\%\text{RH}$ 電源關閉靜態操作下)	1, 2
6	Vibration Test	Total fixed amplitude : 1.5 mm (完全固定輻射：1.5mm) Vibration Frequency : 10 ~ 55 Hz (震動頻率：10~55 Hz) One cycle 60 seconds to 3 directions of X, Y, Z for each 15 minutes (每一個循環 X, Y, Z 軸方向各做 60 秒，連續做 5 次，共計 15 分鐘)	3
7	Shock Test	To be measured after dropping from 60cm high on the concrete surface in packing state. (包裝材從 60 公分高的地面向地面落下)  Dropping method comer dropping (角落落下方式) A comer : once Edge dropping (側邊落下) B, C, D edge : once Face dropping (表面落下) E, F, G face : once	

Note 1 : No dew condensation to be observed. (不要在”水氣凝結點”下觀察)

Note 2 : The function test shall be conducted after 4 hours storage at the normal

Temperature and humidity after removed from the test chamber

(從實驗室移出後，放在一般常溫 (溫度： 25°C ，濕度： $45\%\text{RH}$)，

且四小時後通電流或電壓，看它是否能正常動作)

Note 3 : Vibration test will be conducted to the product itself without putting it in a container.

(在震動測試下，產品本身不需容器即能自行傳導)

19. Reliability Test (測試條件) – Wide Temperature (廣溫)

No change no display and in operation under the following text condition.

(在不改變原先顯示下進行以下測試操作)

Conditions : Unless otherwise specified, test will be conducted under the following condition.

Temperature : $20\pm 5\text{ }^{\circ}\text{C}$

Humidity : $40\pm 5\%\text{RH}$

Tests will be not conducted under functioning state.

(條件：除非其他特殊情況，否則測試將以溫度： $20\pm 5\text{ }^{\circ}\text{C}$ ，濕度： $40\pm 5\%\text{RH}$ 為主)

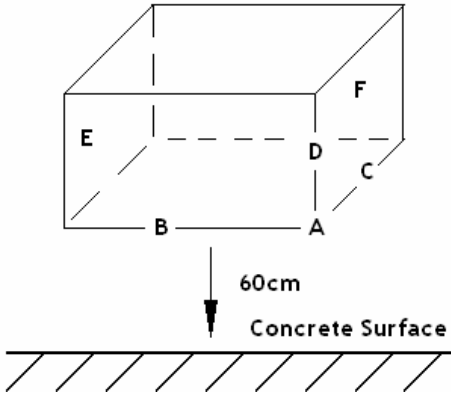
NO	Parameter	Conditions	Notes
1	High Temperature Operating	$70^{\circ}\text{C}\pm 2\text{ }^{\circ}\text{C}$, 96 hrs (operation state) (96 小時，溫度 $70^{\circ}\text{C}\pm 2\text{ }^{\circ}\text{C}$ 電源開啟的操作情況下)	
2	Low Temperature Operating	$-20^{\circ}\text{C}\pm 2\text{ }^{\circ}\text{C}$, 96 hrs (operation state) (96 小時，溫度 $-20^{\circ}\text{C}\pm 2\text{ }^{\circ}\text{C}$ 電源開啟的操作情況下)	1
3	High Temperature Storage	$80^{\circ}\text{C}\pm 2\text{ }^{\circ}\text{C}$, 96 hrs (96 小時，溫度 $80^{\circ}\text{C}\pm 2\text{ }^{\circ}\text{C}$ 電源關閉靜態操作下)	2
4	Low Temperature Storage	$-30^{\circ}\text{C}\pm 2\text{ }^{\circ}\text{C}$, 96 hrs (96 小時，溫度 $-30^{\circ}\text{C}\pm 2\text{ }^{\circ}\text{C}$ 電源關閉靜態操作下)	1, 2
5	Damp Proof Test	$40^{\circ}\text{C}\pm 2\text{ }^{\circ}\text{C}$, 85 ~ 90%RH , 96hr (96 小時，溫度： $40^{\circ}\text{C}\pm 2\text{ }^{\circ}\text{C}$ ，濕度： $85\sim 90\%\text{RH}$ 電源關閉靜態操作下)	1, 2
6	Vibration Test	Total fixed amplitude : 1.5 mm (完全固定輻射：1.5mm) Vibration Frequency : 10 ~ 55 Hz (震動頻率：10~55 Hz) One cycle 60 seconds to 3 directions of X, Y, Z for each 15 minutes (每一個循環 X, Y, Z 軸方向各做 60 秒，連續做 5 次，共計 15 分鐘)	3
7	Shock Test	To be measured after dropping from 60cm high on the concrete surface in packing state. (包裝材從 60 公分高的地方向地面落下)  Dropping method comer dropping (角落落下方式) A comer : once Edge dropping (側邊落下) B, C, D edge : once Face dropping (表面落下) E, F, G face : once	

Note 1 : No dew condensation to be observed. (不要在”水氣凝結點”下觀察)

Note 2 : The function test shall be conducted after 4 hours storage at the normal

Temperature and humidity after removed from the test chamber

(從實驗室移出後，放在一般常溫 (溫度： 25°C ，濕度： $45\%\text{RH}$)，

且四小時後通電流或電壓，看它是否能正常動作)

Note 3 : Vibration test will be conducted to the product itself without putting it in a container.

(在震動測試下，產品本身不需容器即能自行傳導)

20. Precautions Against Product Handling [產品使用注意事項]：

The following precautions will guide you in handling our product correctly.

[下列警戒引導正確地使用產品]

20.1 Care of the LCD module against static electricity discharge. [LCD 模組靜電注意事項]

20.1.1 When working with the module, be sure to ground your body and any electrical equipment you may be using. We strongly recommend the use of anti static mats (made of rubber), to protect work tables against the hazards of electrical shock.

[操作模組時，避免操作者身體接地及任何造成靜電的設備同時使用，強烈建議(橡膠製)抗靜電墊的使用，以免工作台面遭受到電氣干擾]

20.1.2 Slowly and carefully remove the protective film from the LCD module, since this operation can generate static electricity.

[緩慢小心地移除 LCD 模組上的保護膜，以防靜電產生]

20.1.3 Avoid the use of work clothing made of synthetic fibers. We recommend cotton clothing or other conductivity-treated fibers.

[避免穿著人造合成的工作服，建議棉質或是有傳導性的纖維質料]

20.2 Liquid crystal display devices (LCD devices) [液晶螢幕顯示器的組成]

20.2.1 The polarizer adhering to the surface of the LCD is made of a soft material.

Guard against scratching it. [偏光板是軟性原料製成，請勿刮傷]

20.2.2 The LCD device panel used in the LCM is made of plate glass. Avoid any strong mechanical shock. Should the glass break handle it with care.

[模組使用的玻璃為平面玻璃，避免任何強烈的機械撞擊，且觸碰時請小心]

20.3 When the LCD module alone must be stored form long periods of time

[當 LCD 模組須長時間存放時]

20.3.1 Protect the modules from excessive external forces. [避免外力壓迫]

20.3.2 Protect the modules from high temperature and humidity. [避免處於高溫高濕下]

20.3.3 Keep the modules out of direct sunlight or direct exposure to ultraviolet rays.

[遠離陽光曝曬或直接曝露在紫外線下]

20.4 Use the module with a power supply that is equipped with an over current protector circuit, since the module is not provided with this protective feature.

[因為模組本身沒有防護，所以模組的供應器應配有過高電流的保護迴路]

20.5 Do not ingest the LCD fluid itself should it leak out of a damaged LCD module. Should hands or clothing come in contact with LCD fluid, wash immediately with soap.

[LCD 破裂液晶外漏時，切勿食下液晶；若手或衣服接觸到液晶，請立刻用肥皂清洗]

20.6 Conductivity is not guaranteed for models that use metal holders where solder connections between the metal holder and the PCB are not used. Please contact us to discuss appropriate ways to assure conductivity.

[當金屬框並沒焊接於 PCB 板上時，無法保證使用金屬框是具有傳導性，請連絡我們商討適當方式傳導]

20.7 For models which use CCFL [CCFL 的模組]:

20.7.1 High voltage of 1000V or greater is applied to the CCFL cable connector area.

[CCFL 排線連接器用於 1000V 以上的高電壓]

20.7.2 Protect CCFL cables from rubbing against the unit and thus causing the wire jacket to become worn. [CCFL 排線必須有保護 CCFL 與模組磨擦，以防 CCFL 外殼受到損害]

20.7.3 The use of CCFLs for extended periods of time at low temperatures will significantly shorten their service life. [長時間低溫使用 CCFL 會明顯縮減其使用壽命]

20.8 For models which use touch panels [觸控式面板模組]:

20.8.1 Do not stack up modules since they can be damaged by components on neighboring modules.
[勿堆疊模組以防損壞]

20.8.2 Do not place heavy objects on top of the product. This could cause glass breakage.
[勿將重物放置在產品上，會導致玻璃破損]

20.9 For models which use COG & TAB [COG 及 TAB 模組]:

20.9.1 The mechanical strength of the product is low since the IC chip is faces out unprotected from the rear. Be sure to protect the rear of the IC chip from external forces.
[由於 IC 晶片表面無防護，所以抗壓力有限，須加強保護以防外力]

20.9.2 Given the fact that the rear of the IC chip is left exposed, in order to protect the unit from electrical damage, avoid installation configurations in which the rear of the IC chip runs the risk of making any electrical contact.
[勿暴露 IC 晶片以防電氣干擾，且避免安裝 IC 時有任何電子接觸]

20.10 Models which use flexible cable, heat seal, or TAB [加有軟排線、熱封條或 TAB 的模組]:

20.10.1 In order to maintain reliability, do not touch or hold by the connector area.
[以維持產品信賴度，請勿觸碰或握住連接器]

20.10.2 Avoid any bending, pulling, or other excessive force, which can result in broken connections. [避免彎曲、拉扯或過度力量，會造成連接器損壞]

20.11 In case of acrylic plate is attached to front side of LCD panel, cloudiness (very small cracks) can occur on acrylic plate, being influenced by some components generated from polarizer film.

Please check and evaluate those acrylic materials carefully before use.

[貼在 LCD 玻璃前面的壓克力板若有模糊情況(微小裂縫)，即會影響偏光板；使用前請仔細確認壓克力材質]

20.12 In case of buffer material such as cushion/gasket is assembled into LCD module, it may have an adverse effect on connecting parts (LCD panel-TCP/ HEAT SEAL/ FPC, PCB-TCP/HEAT SEAL/FPC, TCP-HEAT SEAL, TCP-FPC, HEAT SEAL-FPC) depending on its materials.

Please check and evaluate these materials carefully before use.

[緩衝原料像是減震墊/襯墊，或許會對連接器(LCD panel-TCP/ HEAT SEAL/ FPC, PCB-TCP/HEAT SEAL/FPC, TCP-HEAT SEAL, TCP-FPC, HEAT SEAL-FPC)造成反效果，使用前請仔細確認材料]

21. Warranty [保證]:

This product has been manufactured to your company's specifications as a part for use in your company's general electronic products. It is guaranteed to perform according to delivery specifications. For any other use apart from general electronic equipment, we cannot take responsibility if the product is used in medical devices, nuclear power control equipment, aerospace equipment, fire and security systems, or any other applications in which there is a direct risk to human life and where extremely high levels of reliability are required. If the product is to be used in any of the above applications, we will need to enter into a separate product liability agreement.

[此產品的製造是依照客戶的規格，被使用於客戶的一般電子產品上，保證產品製作根據出貨的規格，若產品的使用不是在一般電子設備，而組裝於下列產品上則無法受理（如醫療產品、核心電源控制設備、航空設備、防火及保全系統，或任何相關儀器會直接影響人類生命等），若模組使用於上述的儀器，則需商討各別產品責任義務的協定]

- 21.1 We cannot accept responsibility for any defect, which may arise after the application of strong external force to the product.
[不受理因強大外力衝擊造成產品的缺陷]
- 21.2 We cannot accept responsibility for any defect, which may arise from additional manufacturing of the product (including disassembly and reassembly), after product delivery.
[不受理產品出貨後，因額外加工(包含拆裝及重新封包)造成的缺陷]
- 21.3 We cannot accept responsibility for any defect, which may arise due to the application of static electricity after the product, has passed your company's acceptance inspection procedures.
[不受理通過貴公司檢驗流程後，由於靜電造成產品的缺陷]
- 21.4 We cannot accept responsibility for intellectual property of a third party, which may arise through the application of our product to your assembly with exception to those issues relating directly to the structure or method of manufacturing of our product.
[不受理因在客戶產品生產線端所產生的第三人智慧財產權責任，除非與我司生產製造方法有直接關係的問題]
- 21.5 When the product is in CCFL models, CCFL service life and brightness will vary according to the performance of the inverter used, leaks, etc. We cannot accept responsibility for product performance, reliability, or defect, which may arise.
[產品是 CCFL 模組時，CCFL 的壽命及亮度將取決於連接器的性能、漏電量等；無法受理因 CCFL 造成產品性能的缺陷]
- 21.6 SDEC will not be held responsible for any quality guarantee issue for defect products longer than 1(one) year from SDEC production which ever comes later.
[出廠超過一年的瑕疵品，任何品質擔保則不受理]